

**IMPROVISED MUNITIONS**

**BLACK BOOK**

**Volume 1**

# IMPROVISED MUNITIONS BLACK BOOK

Volume 1



**DESERT PUBLICATIONS**

**IMPROVISED MUNITIONS BLACK BOOK**  
**Volume 1**

© 1981

Desert Publications

ISBN: 0 - 87947 - 204-9

**DESERT PUBLICATIONS**  
Cornville, Arizona 86325

IMPROVISED MUNITIONS  
HANDBOOK

TABLE OF CONTENTS

Section

- I EXPLOSIVES AND PROPELLANTS  
(Including Igniters)
- II MINES AND GRENADES
- III SMALL ARMS WEAPONS AND AMMUNITION
- IV MORTARS AND ROCKETS
- V INCENDIARY DEVICES
- VI FUSES, DETONATORS & DELAY MECHANISMS
- VII MISCELLANEOUS

FRANKFORD ARSENAL  
Philadelphia 37, Pennsylvania

For further information or additional inserts, contact:

Commanding Officer  
Frankford Arsenal  
ATTN: SMUFA-U3100, Special Products Division  
Small Caliber Engineering Directorate  
Philadelphia, Pa. 19137

Additional inserts will be made available as evaluation tests are completed. Please notify the above agency of any change of address so that you may receive them.

## INTRODUCTION

### 1. Purpose and Scope

In Unconventional Warfare operations it may be impossible or unwise to use conventional military munitions as tools in the conduct of certain mission. It may be necessary instead to fabricate the required munitions from locally available or unassuming materials. The purpose of this Manual is to increase the potential of Special Forces and guerrilla troops by describing in detail the manufacture of munitions from seemingly innocuous locally available materials.

Manufactured, precision devices almost always will be more effective, more reliable, and easier to use than improvised ones, but shelf items will just not be available for certain operations for security or logistical reasons. Therefore the operator will have to rely on materials he can buy in a drug or paint store, find in a junk pile, or scrounge from military stocks. Also, many of the ingredients and materials used in fabricating homemade items are so commonplace or innocuous they can be carried without arousing suspicion. The completed item itself often is more easily concealed or camouflaged. In addition, the field expedient item can be tailored for the intended target, thereby providing an advantage over the standard item in flexibility and versatility.

The Manual contains simple explanations and illustrations to permit construction of the items by personnel not normally familiar with making and handling munitions. These items were conceived in-house or, obtained from other publications or personnel engaged in munitions or special warfare work. This Manual includes methods for fabricating explosives, detonators, propellants, shaped charges, small arms, mortars, incendiaries, delays, switches, and similar items from indigenous materials.

### 2. Safety and Reliability

Each item was evaluated both theoretically and experimentally to assure safety and reliability. A large number of items were discarded because of inherent hazards or unreliable performance. Safety warnings are prominently inserted in the procedures where they apply but it is emphasized that safety is a matter of attitude. It is a proven fact that men who are alert, who think out a situation, and who take correct precautions have fewer accidents than the careless and indifferent. It is important that work be planned and that instructions be followed to the letter; all work should be done in a neat and orderly manner. In the manufacture of explosives, detonators, propellants and incendiaries, equipment must be kept clean and such energy concentration as sparks,

friction, impact, hot objects, flame, chemical reactions, and excessive pressure should be avoided.

These items were found to be effective in most environments; however, samples should be made and tested remotely prior to actual use to assure proper performance. Chemical items should be used as soon as possible after preparation and kept free of moisture, dirt, and the above energy concentrations. Special care should be taken in any attempt at substitution or use of items for purposes other than that specified or intended.

### 3. User Comments

It is anticipated that this manual will be revised or changed from time to time. In this way it will be possible to update present material and add new items as they become available. Users are encouraged to submit recommended changes or comments to improve this manual. Comments should be keyed to the specific page, paragraph, and line of the text in which changes are recommended. Reasons should be provided for each comment to insure understanding and complete evaluation. Comments should be forwarded directly to Commandant, United States Army, Special Warfare School, Fort Bragg, North Carolina 28307 and Commanding Officer, United States Army, Frankford Arsenal, SMUFA-J8000, Philadelphia, Pennsylvania 19137.

## PLASTIC EXPLOSIVE FILLER

A plastic explosive filler can be made from potassium chlorate and petroleum jelly. This explosive can be detonated with commercial #8 or any military blasting cap.

### MATERIAL REQUIRED

Potassium chlorate

Petroleum jelly (Vaseline)

Piece of round stick

Wide bowl or other container for mixing ingredients.

### HOW USED

Medicine  
Manufacture of matches

Medicine  
Lubricant

### PROCEDURE

1. Spread potassium chlorate crystals thinly on a hard surface. Roll the round stick over crystals to crush into a very fine powder until it looks like face powder or wheat flour.



2. Place 9 parts powdered potassium chlorate and 1 part petroleum jelly in a wide bowl or similar container. Mix ingredients with hands (knead) until a uniform paste is obtained.



**NOTE:** Store explosive in a waterproof container until ready to use.



# FOR OFFICIAL USE ONLY

Section I

No. 2

## POTASSIUM NITRATE

Potassium nitrate (saltpeter) can be extracted from many natural sources and can be used to make nitric acid, black powder and many pyrotechnics. The yield ranges from .1 to 10% by weight, depending on the fertility of the soil.

### MATERIALS

Nitrate bearing earth or other material, about 3-1/2 gallons (13-1/2 liters)

Fine wood ashes, about 1/2 cup (1/8 liter)

Bucket or similar container, about 5 gallons (19 liters) in volume (Plastic, metal, or wood)  
2 pieces of finely woven cloth, each slightly larger than bottom of bucket

Shallow pan or dish, at least as large as bottom of bucket

Shallow heat resistant container (ceramic, metal, etc.)

Water - 1-3/4 gallons (6-3/4 liters)

Awl, knife, screwdriver, or other hole producing instrument

Alcohol about 1 gallon (4 liters) (whiskey, rubbing alcohol, etc.)

Heat source (fire, electric heater, etc.)

Paper

Tape

### SOURCE

Soil containing old decayed vegetable or animal matter

Old cellars and/or farm dirt floors

Earth from old burial grounds

Decayed stone or mortar building foundations

Totally burned whitish wood ash powder

Totally burned paper (black)

NOTE: Only the ratios of the amounts of ingredients are important. Thus, for twice as much potassium nitrate, double quantities used.

**PROCEDURE:**

1. Punch holes in bottom of bucket. Spread one piece of cloth over holes inside of bucket.

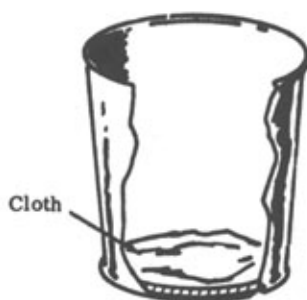

2. Place wood ashes on cloth and spread to make a layer about the thickness of the cloth. Place second piece of cloth on top of ashes.



3. Place dirt in bucket.



4. Place bucket over shallow container. Bucket may be supported on sticks if necessary.

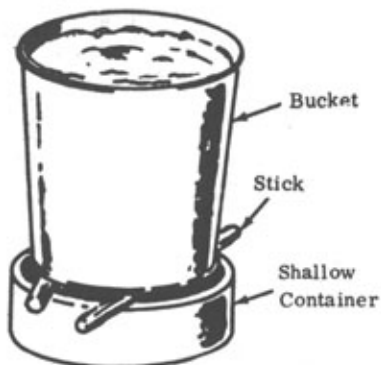

5. Boil water and pour it over earth in bucket a little at a time. Allow water to run through holes in bucket into shallow container. Be sure water goes through all of the earth. Allow drained liquid to cool and settle for 1 to 2 hours.

NOTE: Do not pour all of the water at once, since this may cause stoppage.

6. Carefully drain off liquid into heat resistant container. Discard any sludge remaining in bottom of the shallow container.

7. Boil mixture over hot fire for at least 2 hours. Small grains of salt will begin to appear in the solution. Scoop these out as they form, using any type of improvised strainer (paper, etc.).

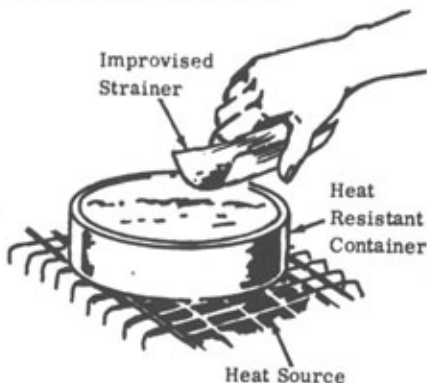

8. When liquid has boiled down to approximately half its original volume, remove from fire and let sit. After half an hour add an equal volume of alcohol. When mixture is poured through paper, small white crystals will collect on top of it.

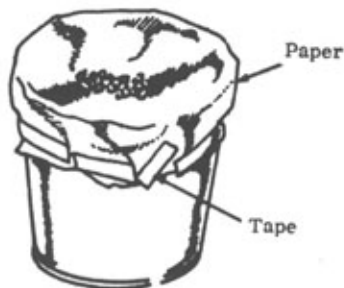

9. To purify the potassium nitrate, re-dissolve the dry crystals in the smallest possible amount of boiled water. Remove any salt crystals that appear (Step 7); pour through an improvised filter made of several pieces of paper and evaporate or gently heat the concentrated solution to dryness.

10. Spread crystals on flat surface and allow to dry. The potassium nitrate crystals are now ready for use.

## IMPROVISED BLACK POWDER

Black powder can be prepared in a simple, safe manner. It may be used as blasting or gun powder.

MATERIAL REQUIRED:

Potassium nitrate, granulated, 3 cups (3/4 liter) (see Sect. I, No. 2)

Wood charcoal, powdered, 2 cups (1/2 liter)

Sulfur, powdered, 1/2 cup (1/8 liter)

Alcohol, 5 pints (2-1/2 liters) (whiskey, rubbing alcohol, etc.)

Water, 3 cups (3/4 liter)

Heat source

2 Buckets - each 2 gallon (7-1/2 liters) capacity, at least one of which is heat resistant (metal, ceramic, etc.)

Flat window screening, at least 1 foot (30 cm) square

Large wooden stick

Cloth, at least 2 feet (60 cm) square

NOTE: The above amounts will yield two pounds (900 grams) of black powder. However, only the ratios of the amounts of ingredients are important. Thus, for twice as much black powder, double all quantities used.

PROCEDURE:

1. Place alcohol in one of the buckets.
2. Place potassium nitrate, charcoal, and sulfur in the heat resistant bucket. Add 1 cup water and mix thoroughly with wooden stick until all ingredients are dissolved.
3. Add remaining water (2 cups) to mixture. Place bucket on heat source and stir until small bubbles begin to form.

**CAUTION:** Do not boil mixture. Be sure all mixture stays wet. If any is dry, as on sides of pan, it may ignite.

4. Remove bucket from heat and pour mixture into alcohol while stirring vigorously.



5. Let alcohol mixture stand about 5 minutes. Strain mixture through cloth to obtain black powder. Discard liquid. Wrap cloth around black powder and squeeze to remove all excess liquid.



6. Place screening over dry bucket. Place workable amount of damp powder on screen and granulate by rubbing solid through screen.

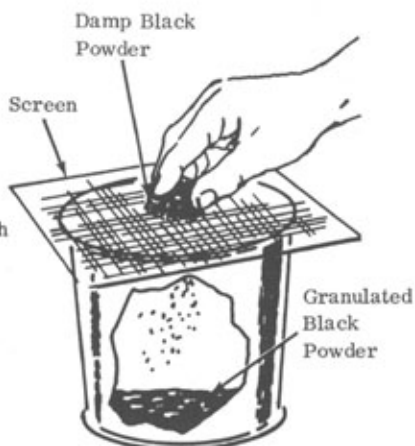

NOTE: If granulated particles appear to stick together and change shape, recombine entire batch of powder and repeat steps 5 and 6.

7. Spread granulated black powder on flat dry surface so that layer about 1/2 inch (1-1/4 cm) is formed. Allow to dry. Use radiator, or direct sunlight. This should be dried as soon as possible, preferably in one hour. The longer the drying period, the less effective the black powder.

**CAUTION:** Remove from heat as soon as granules are dry. Black powder is now ready for use.

## NITRIC ACID

Nitric acid is used in the preparation of many explosives, incendiary mixtures, and acid delay timers. It may be prepared by distilling a mixture of potassium nitrate and concentrated sulfuric acid.

MATERIAL REQUIRED:

Potassium nitrate (2 parts by volume)  
Concentrated sulfuric acid (1 part by volume)  
 2 bottles or ceramic jugs (narrow necks are preferable)  
 Pot or frying pan  
 Heat source (wood, coal, or charcoal)  
 Tape (paper, electrical, masking, etc. but not cellophane)  
 Paper or rags

SOURCES:

Drug Store  
 Improvised (Section I, No. 2)  
 Motor vehicle batteries  
 Industrial plants

**IMPORTANT:** If sulfuric acid is obtained from a motor vehicle battery, concentrate it by boiling it until white fumes appear. **DO NOT INHALE FUMES.**

**NOTE:** The amount of nitric acid produced is the same as the amount of potassium nitrate. Thus, for 2 tablespoonsful of nitric acid, use 2 tablespoonsful of potassium nitrate and 1 tablespoonsful of concentrated sulfuric acid.

PROCEDURE:

1. Place dry potassium nitrate in bottle or jug. Add sulfuric acid. Do not fill bottle more than 1/4 full. Mix until paste is formed.

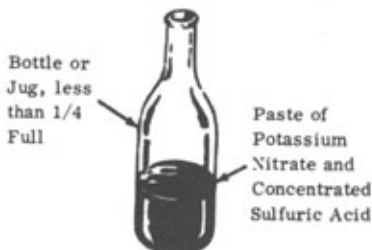

**CAUTION:** Sulfuric acid will burn skin and destroy clothing. If any is spilled, wash it away with a large quantity of water. Fumes are also dangerous and should not be inhaled.

2. Wrap paper or rags around necks of 2 bottles. Securely tape necks of bottles together. Be sure bottles are flush against each other and that there are no air spaces.



3. Support bottles on rocks or cans so that empty bottle is slightly lower than bottle containing paste so that nitric acid that is formed in receiving bottle will not run into other bottle.



4. Build fire in pot or frying pan.
5. Gently heat bottle containing mixture by moving fire in and out. As red fumes begin to appear periodically pour cool water over empty receiving bottle. Nitric acid will begin to form in the receiving bottle.





CAUTION: Do not overheat or wet bottle containing mixture or it may shatter. As an added precaution, place bottle to be heated in heat resistant container filled with sand or gravel. Heat this outer container to produce nitric acid.

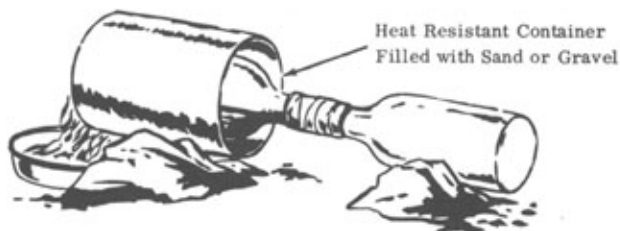

6. Continue the above process until no more red fumes are formed. If the nitric acid formed in the receiving bottle is not clear (cloudy) pour it into cleaned bottle and repeat Steps 2 - 6.

CAUTION: Nitric acid will burn skin and destroy clothing. If any is spilled, wash it away with a large quantity of water. Fumes are also dangerous and should not be inhaled.

Nitric acid should be kept away from all combustibles and should be kept in a sealed ceramic or glass container.

## INITIATOR FOR DUST EXPLOSIONS

An initiator which will initiate common material to produce dust explosions can be rapidly and easily constructed. This type of charge is ideal for the destruction of enclosed areas such as rooms or buildings.

MATERIAL REQUIRED:

A flat can, 3 in. (8 cm) diameter and 1-1/2 in. (3-3/4 cm) high. A 6-1/2 ounce Tuna can serves the purpose quite well.

Blasting cap

Explosive

Aluminum (may be wire, cut sheet, flattened can or powder)

Large nail, 4 in. (10 cm) long

Wooden rod - 1/4 in. (6 mm) diameter

Flour, gasoline and powder or chipped aluminum

NOTE: Plastic explosives (Comp. C-4, etc.) produce better explosions than cast explosives (Comp. B, etc.).

PROCEDURE:

1. Using the nail, press a hole through the side of the Tuna can 3/8 to 1/2 inch (1 to 1-1/2 cm) from the bottom. Using a rotating and lever action, enlarge the hole until it will accommodate the blasting cap.

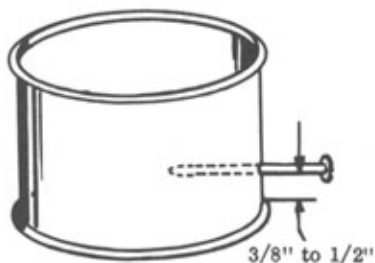

2. Place the wooden rod in the hole and position the end of the rod at the center of the can.

3. Press explosive into the can, being sure to surround the rod, until it is 3/4 inch (2 cm) from top of the can. Carefully remove the wooden rod.

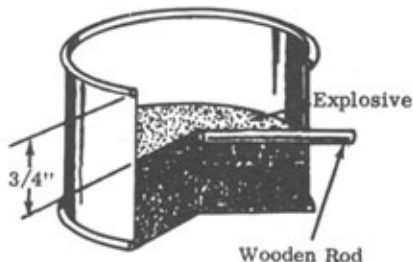

## FOR OFFICIAL USE ONLY

4. Place the aluminum metal on top of the explosive.

5. Just before use, insert the blasting cap into the cavity made by the rod. The initiator is now ready for use.

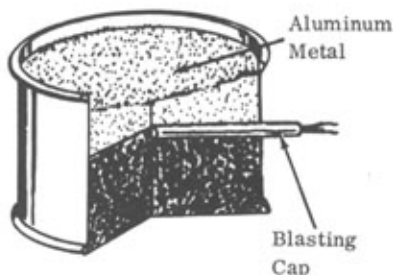

Cardboard Disk Insert  
For Handling Purposes

NOTE: If it is desired to carry the initiator some distance, cardboard may be pressed on top of the aluminum to insure against loss of material.

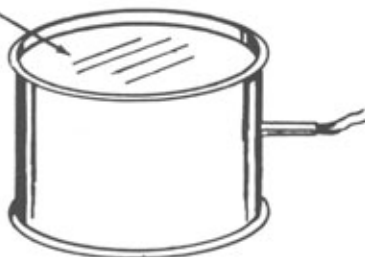

### HOW TO USE:

This particular unit works quite well to initiate charges of five pounds of flour, 1/2 gallon (1-2/3 liters) of gasoline or two pounds of flake painters aluminum. The solid materials may merely be contained in sacks or cardboard cartons. The gasoline may be placed in plastic-coated paper milk cartons, plastic or glass bottles. The charges are placed directly on top of the initiator and the blasting cap is actuated electrically or by fuse depending on the type of cap employed. This will destroy a 2,000 cubic feet enclosure (building 10 x 20 x 10 feet).

NOTE: For larger enclosures, use proportionately larger initiators and charges.

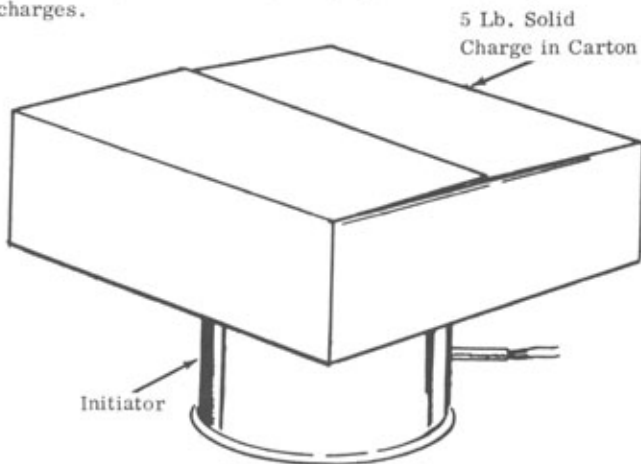

## FERTILIZER EXPLOSIVE

An explosive munition can be made from fertilizer grade ammonium nitrate and either fuel oil or a mixture of equal parts of motor oil and gasoline. When properly prepared, this explosive munition can be detonated with a blasting cap.

MATERIAL REQUIRED:

Ammonium nitrate (not less than 32% nitrogen)  
 Fuel oil or gasoline and motor oil (1:1 ratio)  
 Two flat boards. (At least one of these should be comfortably held in the hand, i.e. 2 x 4 and 36 x 36.)  
 Bucket or other container for mixing ingredients  
 Iron or steel pipe or bottle, tin can or heavy-walled cardboard tube  
 Blasting cap  
 Wooden rod - 1/4 in. diameter  
 Spoon or similar measuring container

PROCEDURE:

1. Spread a handful of the ammonium nitrate on the large flat board and rub vigorously with the other board until the large particles are crushed into a very fine powder that looks like flour (approx. 10 min).



NOTE: Proceed with Step 2 as soon as possible since the powder may take moisture from the air and become spoiled.

2. Mix one measure (cup, tablespoon, etc.) of fuel oil with 16 measures of the finely ground ammonium nitrate in a dry bucket or other suitable container and stir with the wooden rod. If fuel oil is not available, use one half measure of gasoline and one half measure of motor oil. Store in a waterproof container until ready to use.



3. Spoon this mixture into an iron or steel pipe which has an end cap threaded on one end. If a pipe is not available, you may use a dry tin can, a glass jar or a heavy-walled cardboard tube.



NOTE: Take care not to tamp or shake the mixture in the pipe. If mixture becomes tightly packed, one cap will not be sufficient to initiate the explosive.

4. Insert blasting cap just beneath the surface of the explosive mix.

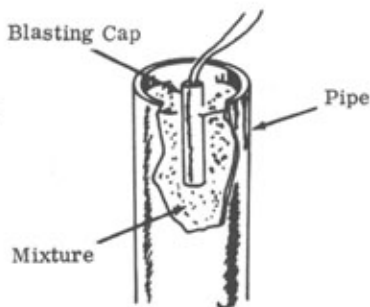

NOTE: Confining the open end of the container will add to the effectiveness of the explosive.

## CARBON TET - EXPLOSIVE

A moist explosive mixture can be made from fine aluminum powder combined with carbon tetrachloride or tetrachloroethylene. This explosive can be detonated with a blasting cap.

MATERIAL REQUIRED:

Fine aluminum bronzing powder  
Carbon tetrachloride  
or  
tetrachloroethylene  
Stirring rod (wood)  
Mixing container (bowl, bucket, etc.)  
Measuring container (cup, table-  
spoon, etc.)  
Storage container (jar, can, etc.)  
Blasting cap  
Pipe, can or jar

SOURCE

Paint Store  
Pharmacy, or fire extin-  
guisher fluid  
Dry cleaners, Pharmacy

PROCEDURE:

1. Measure out two parts aluminum powder to one part carbon tetrachloride or tetrachloroethylene liquid into mixing container, adding liquid to powder while stirring with the wooden rod.
2. Stir until the mixture becomes the consistency of honey syrup.



**CAUTION:** Fumes from the liquid are dangerous and should not be inhaled.

3. Store explosive in a jar or similar water proof container until ready to use. The liquid in the mixture evaporates quickly when not confined.



NOTE: Mixture will detonate in this manner for a period of 72 hours.

HOW TO USE:

1. Pour this mixture into an iron or steel pipe which has an end cap threaded on one end. If a pipe is not available, you may use a dry tin can or a glass jar.



2. Insert blasting cap just beneath the surface of the explosive mix.

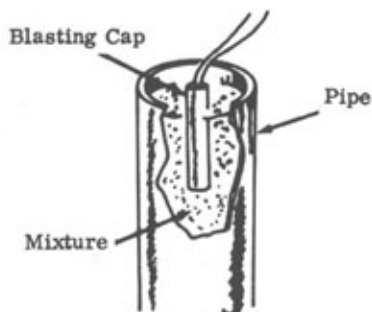

NOTE: Confining the open end of the container will add to the effectiveness of the explosive.

## FERTILIZER AN-AL EXPLOSIVE

A dry explosive mixture can be made from ammonium nitrate fertilizer combined with fine aluminum powder. This explosive can be detonated with a blasting cap.

MATERIAL REQUIRED:SOURCE

Ammonium nitrate fertilizer  
(not less than 32% nitrogen)  
Fine aluminum bronzing powder  
Measuring container (cup, table-  
spoon, etc.)  
Mixing container (wide bowl, can,  
etc.)  
Two flat boards (one should be  
comfortably held in hand and  
one very large, i.e.  
2 x 4 and 36 x 36 in.)  
Storage container (jar, can, etc.)  
Blasting cap  
Wooden rod - 1/4 inch diameter  
Pipe, can or jar

Farm or Feed Store

Paint Store

PROCEDURE:

1. Method I - To obtain a low velocity explosive.
  - a. Use measuring container to measure four parts fertilizer to one part aluminum powder and pour into the mixing container. (Example: 4 cups of fertilizer to 1 cup aluminum powder.)
  - b. Mix ingredients well with the wooden rod.
2. Method II - To obtain a much higher velocity explosive.
  - a. Spread a handful at a time of the fertilizer on the large flat board and rub vigorously with the other board until the large particles are crushed into a very fine powder that looks like flour (approx. 10 min per handful).



NOTE: Proceed with step b below as soon as possible since the powder may take moisture from the air and become spoiled.



b. Follow steps a and b of Method I.

3. Store the explosive mixture in a waterproof container, such as glass jar, steel pipe, etc., until ready to use.



HOW TO USE:

Follow steps 1 and 2 of "How To Use" in Section I, No. 7.

**"RED OR WHITE POWDER" PROPELLANT**

"Red or White Powder" Propellant may be prepared in a simple, safe manner. The formulation described below will result in approximately 2-1/2 pounds of powder. This is a small arms propellant and should only be used in weapons with 1/2 in. inside diameter or less, such as the Match Gun or the 7.62 Carbine, but not pistols.

**MATERIAL REQUIRED:**

Heat source (Kitchen stove or open fire)  
2 gallon metal bucket  
Measuring cup (8 ounces)  
Wooden spoon or rubber spatula  
Metal sheet or aluminum foil (at least 18 in. sq.)  
Flat window screen (at least 1 ft. sq.)  
Potassium nitrate (granulated) 2-1/3 cups  
White sugar (granulated) 2 cups  
Powdered ferric oxide (rust) 1/8 cup (if available)  
Clear water, 3-1/2 cups

**PROCEDURE:**

1. Place the sugar, potassium nitrate, and water in the bucket. Heat with a low flame, stirring occasionally until the sugar and potassium nitrate dissolve.



2. If available, add the ferric oxide (rust) to the solution. Increase the flame under the mixture until it boils gently.



NOTE: The mixture will retain the rust coloration.

3. Stir and scrape the bucket sides occasionally until the mixture is reduced to one quarter of its original volume, then stir continuously.
4. As the water evaporates, the mixture will become thicker until it reaches the consistency of cooked breakfast cereal or homemade fudge. At this stage of thickness, remove the bucket from the heat source, and spread the mass on the metal sheet.



5. While the material cools, score it with the spoon or spatula in crisscrossed furrows about 1 inch apart.

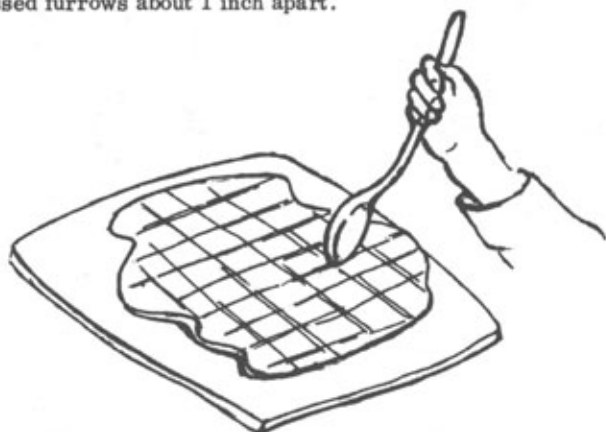

6. Allow the material to air dry, preferably in the sun. As it dries, rescore it occasionally (about every 20 minutes) to aid drying.

7. When the material has dried to a point where it is moist and soft but not sticky to the touch, place a small spoonful on the screen. Rub the material back and forth against the screen mesh with spoon or other flat object until the material is granulated into small worm-like particles.



8. After granulation, return the material to the sun to dry completely.

## NITRIC ACID/NITROBENZENE ("HELLHOFFITE") EXPLOSIVE

An explosive munition can be made from mononitrobenzene and nitric acid. It is a simple explosive to prepare. Just pour the mononitrobenzene into the acid and stir.

MATERIAL REQUIRED:

Nitric acid  
 Mononitrobenzene (also known as nitrobenzene)  
 Acid resistant measuring containers  
 Acid resistant mixing rod  
 Blasting cap  
 Wax  
 Steel pipe, end cap and tape  
 Bottle or jar

SOURCE:

Field grade or 90% concentrated (specific gravity of 1.48)  
 Drug store (oil of mirbane)  
 Chemical supply house  
 Industries (used as solvent)  
 Glass, clay, etc.

NOTE: Prepare mixture just before use.

PROCEDURE:

1. Add 1 volume (cup, quart, etc.) mononitrobenzene to 2 volumes nitric acid in bottle or jar.



2. Mix ingredients well by stirring with acid resistant rod.



**CAUTION:** Nitric acid will burn skin and destroy clothing. If any is spilled, wash off immediately with large amount of water. Nitrobenzene is toxic; do not inhale fumes.

HOW TO USE:

1. Wax blasting cap, pipe and end cap.
2. Thread end cap onto pipe.



3. Pour mixture into pipe.

4. Insert and tape blasting cap just beneath surface of mixture.

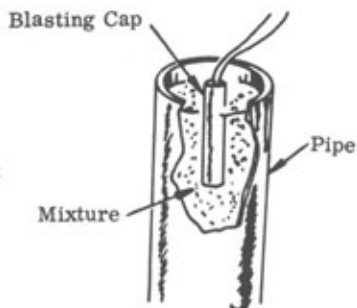

**NOTE:** Combining the open end of the pipe will add to the effectiveness of the explosive.

## OPTIMIZED PROCESS FOR CELLULOSE/ACID EXPLOSIVES

An acid type explosive can be made from nitric acid and white paper or cotton cloth. This explosive can be detonated with a commercial #8 or any military blasting cap.

MATERIAL REQUIRED:SOURCE:

Nitric Acid

Industrial metal processors, 90%  
concentrated (specific gravity  
of 1.48)

White unprinted, unsized paper  
Clean white cotton cloth  
Acid resistant container

Field grade (See Section I, No. 4)

Paper towels, napkins

Clothing, sheets, etc.

Wax coated pipe or can, ceramic  
pipe, glass jar, etc.

Heavy-walled glass containers

Food stores

Aluminum foil or acid resistant  
material

Protective gloves

Blasting cap

Wax

PROCEDURE:

1. Put on gloves.
2. Spread out a layer of paper or cloth on aluminum foil and sprinkle with nitric acid until thoroughly soaked. If aluminum foil is unavailable, use an acid resistant material (glass, ceramic or wood).

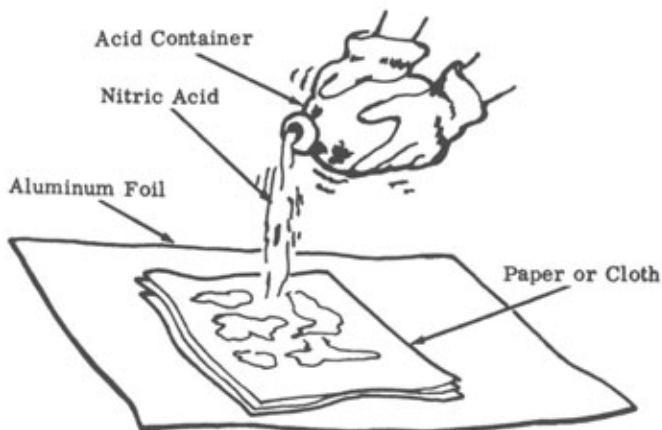

**CAUTION:** Acid will burn skin and destroy clothing. If any is spilled, wash it away with a large quantity of water. Do not inhale fumes.

3. Place another layer of paper or cloth on top of the acid-soaked sheet and repeat step 2 above. Repeat as often as necessary.



4. Roll up the aluminum foil containing the acid-soaked sheets and insert the roll into the acid resistant container.

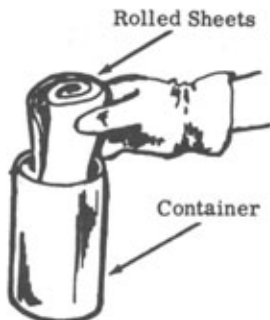

**NOTE:** If glass, ceramic or wooden tray is used, pick up sheets with two wooden sticks and load into container.

5. Wax blasting cap.

6. Insert the blasting cap in the center of the rolled sheets. Allow 5 minutes before detonating the explosive.





## METHYL NITRATE DYNAMITE

A moist explosive mixture can be made from sulfuric acid, nitric acid and methyl alcohol. This explosive can be detonated with a blasting cap.

MATERIAL REQUIRED:

Sulfuric acid

Nitric acid

Methyl alcohol

Eyedropper or syringe with glass tube

Large diameter glass (2 qt.) jar

Narrow glass jars (1 qt.)

Absorbent (fine sawdust, shredded paper, shredded cloth)

Cup

Pan (3 to 5 gallon)

Teaspoon

Wooden stick

Steel pipe with end cap

Blasting cap

Water

Tray

SOURCES:

Clear battery acid boiled until white fumes appear

Field grade nitric acid (Section I, No. 4) or 90% conc. (sp. gr. of 1.48)

Methanol

Wood alcohol (not denatured alcohol)

Anti-freeze (non-permanent)

PROCEDURE:

1. Add 24 teaspoons of sulfuric acid to 16-1/2 teaspoons of nitric acid in the 2 quart jar.



**CAUTION:** Acid will burn skin and destroy clothing. If any is spilled, wash it away with a large quantity of water. Do not inhale fumes.

2. Place the jar in the pan (3 to 5 gallon) filled with cold water or a stream and allow acid to cool.

3. Rapidly swirl the jar to create a whirlpool in the liquid (without splashing) while keeping the bottom portion of the jar in the water.

4. While continually swirling, add to mixture, 1/2 teaspoon at a time, 13-1/2 teaspoons of methyl alcohol, allowing mixture to cool at least one minute between additions.



**CAUTION:** If there is a sudden increase in the amount of fumes produced or if the solution suddenly turns much darker or begins to froth, dump solution in the water within 10 seconds. This will halt the reaction and prevent an accident.

5. After the final addition of methyl alcohol, swirl for another 30 to 45 seconds.

6. Carefully pour the solution into one of the narrow glass jars. Allow jar to stand in water for approximately 5 minutes until two layers separate.

7. With an eyedropper or syringe, remove top layer and carefully put into another narrow glass jar. This liquid is the explosive.



**CAUTION:** Explosive is shock sensitive.

8. Add an equal quantity of water to the explosive and swirl. Allow mixture to separate again as in step 6. The explosive is now the bottom layer.



9. Carefully remove the top layer with the eyedropper or syringe and discard.

10. Place one firmly packed cup of absorbent in the tray.

11. While stirring with the wooden stick, slowly add explosive until the mass is very damp but not wet enough to drip. Explosive is ready to use.



NOTE: If mixture becomes too wet, add more absorbent.

If storage of explosive is required, store in a sealed container to prevent evaporation.

**CAUTION:** Do not handle liquid explosive or allow to contact skin. If this happens, flush away immediately with large quantity of water. Keep grit, sand or dirt out of mix.

HOW TO USE:

1. Spoon this mixture into an iron or steel pipe which has an end cap threaded on one end. If a pipe is not available, you may use a dry tin can or a glass jar.



2. Insert blasting cap just beneath the surface of the explosive mix.

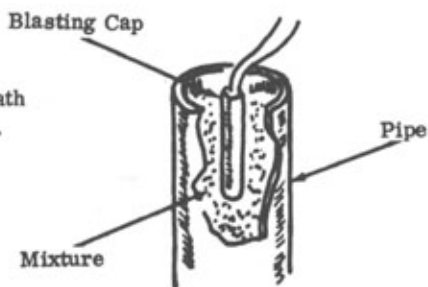

**NOTE:** Confining the open end of the container will add to the effectiveness of the explosive.

## UREA NITRATE EXPLOSIVE

Urea nitrate can be used as an explosive munition. It is easy to prepare from nitric acid and urine. It can be detonated with a blasting cap.

MATERIAL REQUIRED:

Nitric acid, 90% conc. (1.48  
sp. gr.)  
Urine  
2 one gallon heat and acid-  
resistant containers (glass,  
clay, etc.)  
Filtering material  
Aluminum powder (optional or  
if available)  
Heat source  
Measuring containers (cup and  
spoon)  
Water  
Tape  
Blasting cap  
Steel pipe and end cap (s)

SOURCE:

Field grade (Section I, No. 4)  
or industrial metal  
processors  
Animals (including humans)  
Paper towel or finely textured  
cotton cloth (shirt, sheet,  
etc.)  
Paint stores

NOTE: Prepare mixture just before use.

PROCEDURE:

1. Boil a large quantity of urine (10 cups) to approximately 1/10 its volume (1 cup) in one of the containers over the heat source.



2. Filter the urine into the other container through the filtering material to remove impurities.

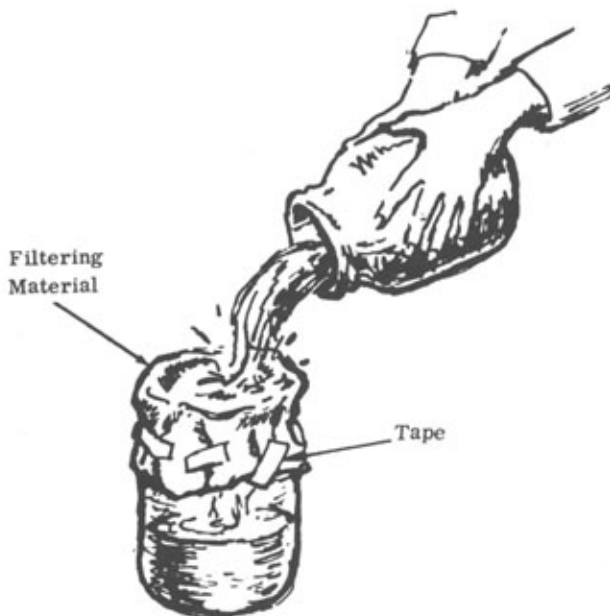

3. Slowly add 1/3 cup of nitric acid to the filtered urine, and let mixture stand for 1 hour.



**CAUTION:** Acid will burn skin and destroy clothing. If any is spilled wash it away with a large quantity of water. Do not inhale fumes.

4. Filter mixture as in step 2. Urea nitrate crystals will collect on the paper.

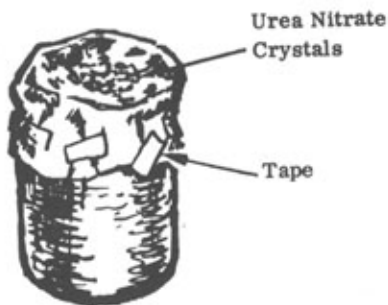

5. Wash the urea nitrate by pouring water over it.
6. Remove urea nitrate crystals from the filtering material and allow to dry thoroughly (approximately 16 hours).

NOTE: The drying time can be reduced to two hours if a hot (not boiling) water bath is used. See Step 5 of Section I, No. 15.

HOW TO USE:

1. Spoon the urea nitrate crystals into an iron or steel pipe which has an end cap threaded on one end.



2. Insert blasting cap just beneath the surface of the urea nitrate crystals.

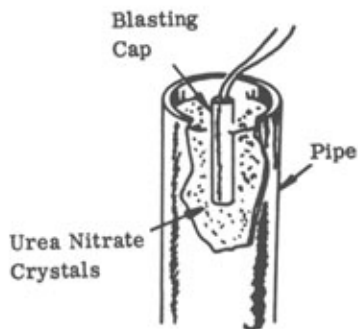

NOTES: This explosive can be made more effective by mixing with aluminum powder (can be obtained in paint stores) in the ratio of 4 to 1. For example, mix 1 cup of aluminum powder with 4 cups of urea nitrate.

Confining the open end of the container will add to the effectiveness of the explosive.



## PREPARATION OF COPPER SULFATE (PENTAHYDRATE)

Copper sulfate is a required material for the preparation of TACC (Section I, No. 16).

MATERIAL REQUIRED:

Pieces of copper or copper wire  
 Dilute sulfuric acid (battery acid)  
 Potassium Nitrate (Section I, No. 2) or Nitric Acid, 90% conc. (1.48 sp. gr.) (Section I, No. 4)  
 Alcohol  
 Water  
 Two 1 pint jars or glasses, heat resistant  
 Paper towels  
 Pan  
 Wooden rod or stick  
 Improved Scale (Section VII, No. 8)  
 Cup  
 Container  
 Heat source  
 Teaspoon

PROCEDURE:

1. Place 10 grams of copper pieces into one of the pint jars. Add 1 cup (240 milliliters) of dilute sulfuric acid to the copper.

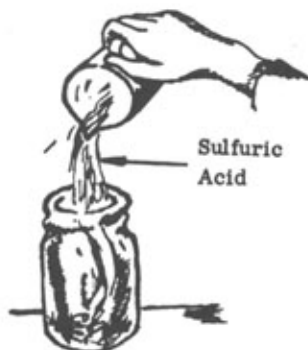

2. Add 12 grams of potassium nitrate or 1-1/2 teaspoons of nitric acid to the mixture.



NOTE: Nitric acid gives a product of greater purity.

3. Heat the mixture in a pan of simmering hot water bath until the bubbling has ceased (approximately 2 hours). The mixture will turn to a blue color.

Hot Water  
Bath



**CAUTION:** The above procedure will cause strong toxic fumes. Perform Step 3 in an open, well ventilated area.

4. Pour the hot blue solution, but not the copper, into the other pint jar. Allow solution to cool at room temperature. Crystals will form at the bottom of the jar. Discard the unreacted copper pieces in the first jar.

5. Carefully pour away the liquid from the crystals. Crush crystals into a powder with wooden rod or stick.

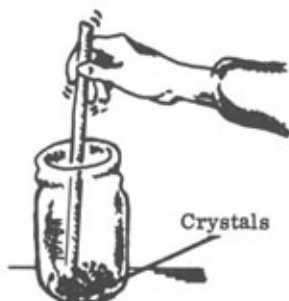

6. Add 1/2 cup (120 milliliters) of alcohol to the powder while stirring.



7. Filter the solution through a paper towel into a container to collect the crystals. Wash the crystals left on the paper towel three times, using 1/2 cup (120 milliliters) portions of alcohol each time.

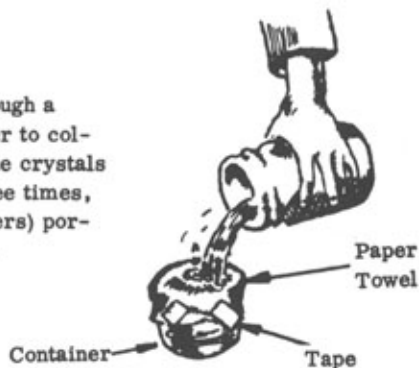

8. Air dry the copper sulfate crystals for 2 hours.

NOTE: Drying time can be reduced to 1/2 hour by use of hot, not boiling, water bath (see Step 3).

## RECLAMATION OF RDX FROM C-4

RDX can be obtained from C-4 explosive with the use of gasoline. It can be used as a booster explosive for detonators (Section VI, No. 13) or as a high explosive charge.

MATERIAL REQUIRED:

Gasoline	
C-4 explosive	
2 pint glass jars, wide mouth	
Paper towels	
Stirring rod (glass or wood)	
Water	} Optional (RDX can be air dried instead)
Ceramic or glass dish	
Pan	
Heat Source	
Teaspoon	
Cup	
Tape	

PROCEDURE:

1. Place 1-1/2 teaspoons (15 grams) of C-4 explosive in one of the pint jars. Add 1 cup (240 milliliters) of gasoline.

NOTE: These quantities can be increased to obtain more RDX. For example, use 2 gallons of gasoline per 1 cup of C-4.

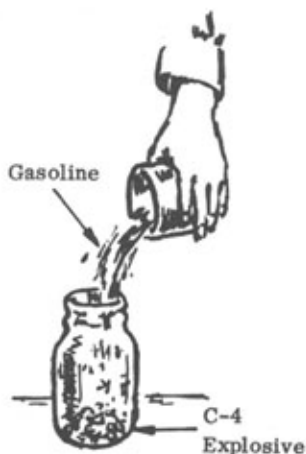

2. Knead and stir the C-4 with the rod until the C-4 has broken down into small particles. Allow mixture to stand for 1/2 hour.



3. Stir the mixture again until a fine white powder remains on the bottom of the jar.

4. Filter the mixture through a paper towel into the other glass jar. Wash the particles collected on the paper towel with 1/2 cup (120 milliliters) of gasoline. Discard the waste liquid.



5. Place the RDX particles in a glass or ceramic dish. Set the dish in a pan of hot water, not boiling, and dry for a period of 1 hour.

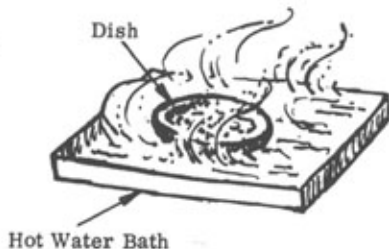

NOTE: The RDX particles may be air dried for a period of 2 to 3 hours.

## TACC (TETRAMMINECOPPER (II) CHLORATE)

Tetramminecopper (II) chlorate is a primary explosive that can be made from sodium chlorate, copper sulfate and ammonia. This explosive is to be used with a booster explosive such as picric acid (Section I, No. 21) or RDX (Section I, No. 15) in the fabrication of detonators (Section 6, No. 13)

MATERIAL REQUIRED:

Sodium chlorate

Copper sulfate

Ammonia hydroxide

Alcohol, 95% pure

Wax, clay, pitch, etc.

Water

Bottle, narrow mouth (wine or coke)

Bottles, wide mouth (mason jars)

Tubing (rubber, copper, steel) to fit narrow mouth bottle

Teaspoon

Improvised scale

Heat source

Paper towel

Pan

Tape

Cup

SOURCES:

Section I, No. 23

Medicine

Weed killer, hardware store

Section I, No. 14

Insecticide, hardware store

Water purifying agent

Household ammonia

Smelling salts

Section VII, No. 8

PROCEDURE:

1. Measure  $\frac{1}{3}$  teaspoon (2- $\frac{1}{2}$  grams) of sodium chlorate into a wide mouth bottle. Add 10 teaspoons of alcohol.



2. Place the wide mouth bottle in a pan of hot water. Add 1 teaspoon (4 grams) of copper sulfate to the mixture. Heat for a period of 30 minutes just under the boiling point and stir occasionally.



**CAUTION:** Keep solution away from flame.

**NOTE:** Keep volume of solution constant by adding additional alcohol approximately every 10 minutes.

3. Remove solution from pan and allow to cool. Color of solution will change from blue to light green. Filter solution through a paper towel into another wide mouth bottle. Store solution until ready for step 6.



4. Add 1 cup (250 milliliters) of ammonia to the narrow mouth bottle.



5. Place tubing into the neck of bottle so that it extends about 1-1/2 inches (4 cm) inside bottle. Seal tubing to bottle with wax, clay, pitch, etc.

6. Place free end of tubing into the chlorate-alcohol-sulfate solution (Step 3). Heat bottle containing ammonia in a pan of hot water, but not boiling, for approximately 10 minutes.

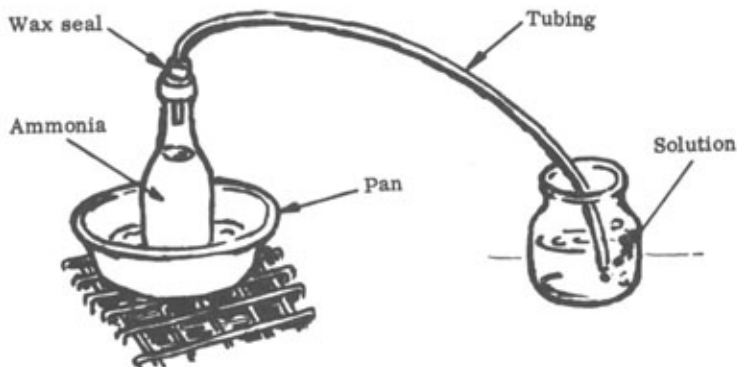

7. Bubble ammonia gas through the chlorate-alcohol-sulfate solution, approximately 10 minutes, until the color changes from light green to dark blue. Continue bubbling for another 10 minutes.

**CAUTION:** At this point the solution is a primary explosive. Keep away from flame.

8. Remove the solution from the pan and reduce the volume to about 1/3 of its original volume by evaporating in the open air or in a stream of air.

**NOTE:** Pour solution into a flat container for faster evaporation.

9. Filter the solution through a paper towel into a wide mouth bottle to collect crystals. Wash crystals with 1 teaspoon of alcohol and set aside to dry (approx. 16 hours).

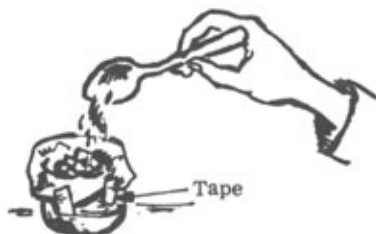

**CAUTION:** Explosive is shock and flame sensitive. Store in a capped container.

**NOTE:** The drying time can be reduced to 2 hours if a hot (not boiling) water bath is used.



## HMTD

HMTD is a primary explosive that can be made from hexamethylenetetramine, hydrogen peroxide and citric acid. This explosive is to be used with a booster explosive such as picric acid (Section I, No. 21) or RDX (Section I, No. 15) in the fabrication of detonators (Section 6, No. 13).

MATERIAL REQUIRED:

Hexamethylenetetramine

Hydrogen peroxide

Citric acid

Containers, bottles or glasses

Paper towels

Teaspoon

Pan

Water

Tape

SOURCES:

Drugstores under names of urotropine, hexamin, methenamine, etc.

Army heat tablets.

6% hair bleach (or stronger if possible)

Drug stores or food stores ("Sour Salt")

PROCEDURE:

1. Measure 9 teaspoons of hydrogen peroxide into a container.
2. In 3 portions, dissolve 2-1/2 teaspoons of crushed hexamethylenetetramine in the peroxide.



3. Keep the solution cool for 30 minutes by placing container in a pan of cold water.

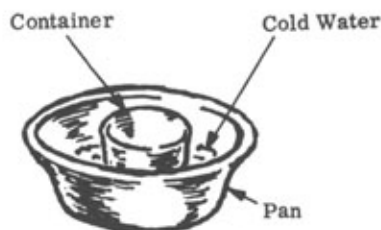

4. In 5 portions, dissolve 4-1/2 teaspoons of crushed citric acid in the hexamethylenetetramine-peroxide solution.

5. Permit solution to stand at room temperature until solid particles form at the bottom of container.



NOTE: Complete precipitation will take place in 8 to 24 hours.

**CAUTION:** At this point the mixture is a primary explosive. Keep away from flame.

6. Filter the mixture through a paper towel into a container to collect the solid particles.



7. Wash the solid particles collected in the paper towel with 6 teaspoons of water by pouring the water over them. Discard the liquid in the container.
8. Place these explosive particles in a container and allow to dry.

**CAUTION:** Handle dry explosive with great care. Do not scrape or handle it roughly. Keep away from sparks or open flames. Store in cool, dry place.

## POTASSIUM OR SODIUM NITRITE AND LITHARGE (LEAD MONOXIDE)

Potassium or sodium nitrite is needed to prepare DDNP (Section I, No. 19), and litharge is required for the preparation of lead picrate (Section I, No. 20).

MATERIAL REQUIRED:

Lead metal (small pieces or chips)  
 Potassium (or sodium) nitrate  
 Methyl (wood) alcohol  
 Iron pipe with end cap  
 Iron rod or screwdriver  
 Paper towels  
 2 glass jars, wide mouth  
 Metal pan  
 Heat source (hot coals or blow torch)  
 Improvised scale (Section VII, No. 8)  
 Cup  
 Water  
 Pan

SOURCE:

Plumbing supply store  
 Field grade (Section I, No. 2)  
 or Drug Store

PROCEDURE:

1. Mix 12 grams of lead and 4 grams of potassium or sodium nitrate in a jar. Place the mixture in the iron pipe.

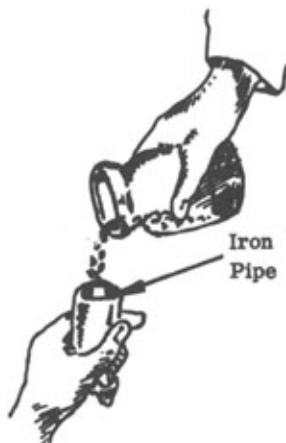

2. Heat iron pipe in a bed of hot coals or with blow torch for 30 minutes to 1 hour. (Mixture will change to a yellow color.)

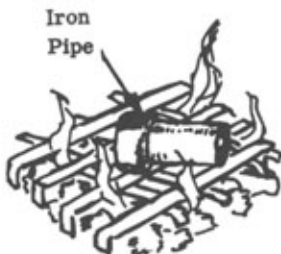

3. Remove the iron pipe from the heat source and allow to cool. Chip out the yellow material formed in the iron pipe and place the chips in the glass jar.

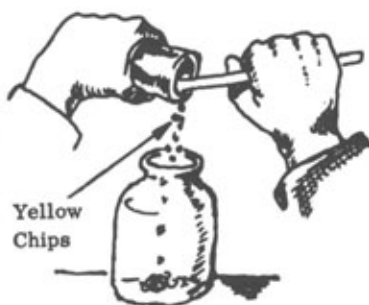

4. Add 1/2 cup (120 milliliters) of methyl alcohol to the chips.

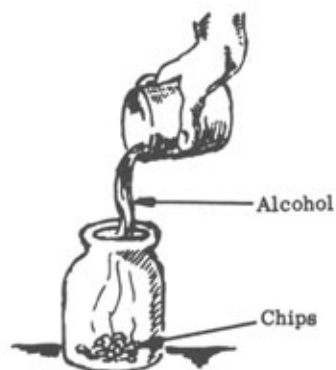

5. Heat the glass jar containing the mixture in a hot water bath for approximately 2 minutes (heat until there is a noticeable reaction between chips and alcohol; solution will turn darker).

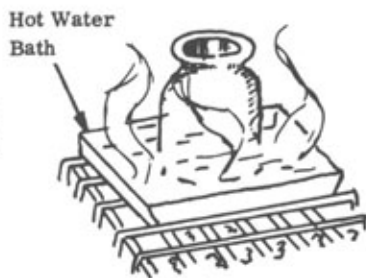

6. Filter the mixture through a paper towel into the other glass jar. The material left on the paper towel is lead monoxide.

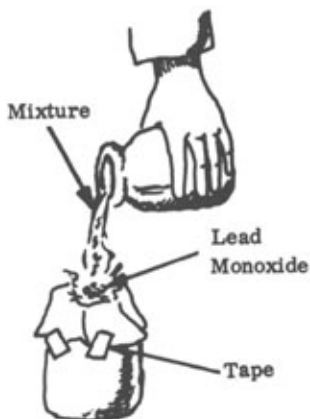

7. Remove the lead monoxide and wash it twice through a paper towel using 1/2 cup (120 milliliters) of hot water each time. Air dry before using.

8. Place the jar with the liquid (from Step 6) in a hot water bath (as in Step 5) and heat until the alcohol has evaporated. The powder remaining in the jar after evaporation is potassium or sodium nitrite.

NOTE: Nitrite has a strong tendency to absorb water from the atmosphere and should be stored in a closed container.

## DDNP

DDNP is a primary explosive used in the fabrication of detonators (Section VI, No. 13). It is to be used with a booster explosive such as picric acid (Section I, No. 21) or RDX (Section I, No. 15).

MATERIAL REQUIRED:

Picric acid  
Flowers of sulfur  
Lye (sodium hydroxide)  
Sulfuric acid, diluted  
Potassium or sodium nitrite  
Water  
2 glass cups, heat resistant,  
(Pyrex)  
Stirring rod (glass or wood)  
Improvised scale  
Paper towels  
Teaspoon  
Tablespoon  
Eyedropper  
Heat source  
Containers  
Tape

SOURCES:

Section I, No. 21  
  
Motor vehicle batteries  
Section I, No. 18  
  
Section VII, No. 8

PROCEDURE:

1. In one of the glass cups, mix  $\frac{1}{2}$  gram of lye with 2 tablespoons (30 milliliters) of warm water.



2. Dissolve 1 teaspoon (3 grams) of picric acid in the water-lye solution. Store until ready for step 5.



FOR OFFICIAL USE ONLY

3. Place 1/4 teaspoon (1 milliliter) of water in the other glass cup. Add 1/2 teaspoon (2-1/2 grams) of sulfur and 1/3 teaspoon (2-1/2 grams) of lye to the water.

4. Boil solution over heat source until color turns dark red. Remove and allow solution to cool.



5. In three portions, add this sulfur-lye solution to the picric acid-lye solution (Step 2); stir while pouring. Allow mixture to cool.



6. Filter the mixture through a paper towel into a container. Small red particles will collect on the paper. Discard the liquid in the container.



7. Dissolve the red particles in 1/4 cup (60 milliliters) of boiling water.



FOR OFFICIAL USE ONLY

8. Remove and filter the mixture through a paper towel as in step 6. Discard the particles left on the paper.

9. Using an eyedropper, slowly add the sulfuric acid to the filtered solution until it turns orange-brown.



10. Add 1/2 teaspoon (2-1/2 grams) more of sulfuric acid to the solution. Allow the solution to cool to room temperature.

11. In a separate container, dissolve 1/4 teaspoon (1.8 grams) of potassium or sodium nitrite in 1/3 cup (80 milliliters) of water.

12. Add this solution in one portion, while stirring, to the orange-brown solution. Allow the mixture to stand for 10 minutes. The mixture will turn light brown.

**CAUTION:** At this point the mixture is a primary explosive. Keep away from flame.

13. Filter the mixture through a paper towel. Wash the particles left on the paper with 4 teaspoons (20 milliliters) of water.



14. Allow the particles to dry (approx. 16 hours).

**CAUTION:** Explosive is shock and flame sensitive. Store explosive in a capped container.

**NOTE:** The drying time can be reduced to 2 hours if a hot (not boiling) water bath is used. See Section I, No. 16.



## PREPARATION OF LEAD PICRATE

Lead picrate is used as a primary explosive in the fabrication of detonators (Section VI, No. 13). It is to be used with a booster explosive such as picric acid (Section I, No. 21) or RDX (Section I, No. 15).

MATERIAL REQUIRED:

Litharge (lead monoxide)  
 Picric Acid  
 Wood alcohol (methanol)  
 Wooden or plastic rod  
 Dish or saucer (china or glass)  
 Teaspoon  
 Improvised Scale  
 Containers  
 Flat pan  
 Heat source (optional)  
 Water (optional)

SOURCE:

Section I, No. 18 or plumbing  
 supplies  
 Section I, No. 21  
 Paint removers; some antifreezes  
  
 Section VII, No. 8

PROCEDURE:

1. Weigh 2 grams each of picric acid and lead monoxide. Place each in a separate container.

2. Place 2 teaspoons (10 milliliters) of the alcohol in a dish. Add the picric acid to the alcohol and stir with the wooden or plastic rod.



3. Add the lead monoxide to the mixture while stirring.

**CAUTION:** At this point the solution is a primary explosive. Keep away from flame.

4. Continue stirring the mixture until the alcohol has evaporated. The mixture will suddenly thicken.

5. Stir mixture occasionally (to stop lumps from forming) until a powder is formed. A few lumps will remain.



**CAUTION:** Be very careful of dry material forming on the inside of the container.

6. Spread this powdered mixture, the lead picrate, in a flat pan to air dry.

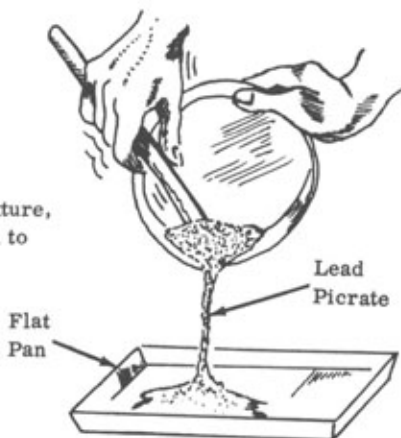

**NOTE:** If possible, dry the mixture in a hot, not boiling, water bath for a period of 2 hours.

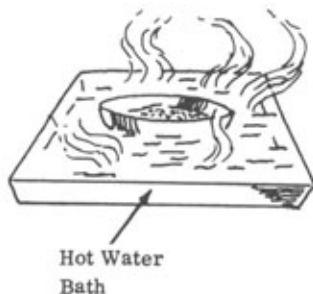

PREPARATION OF PICRIC ACID FROM ASPIRIN

Picric acid can be used as a booster explosive in detonators (Section VI, No. 13), a high explosive charge, or as an intermediate to preparing lead picrate (Section I, No. 20) or DDNP (Section I, No. 19).

MATERIAL REQUIRED:

Aspirin tablets (5 grains per tablet)  
Alcohol, 95% pure  
Sulfuric acid, concentrated, (battery acid - boil until white fumes appear)  
Potassium Nitrate (Section I, No. 2)  
Water  
Paper towels  
Canning jar, 1 pint  
Rod (glass or wood)  
Glass containers  
Ceramic or glass dish  
Cup  
Teaspoon  
Tablespoon  
Pan  
Heat Source  
Tape

PROCEDURE:

1. Crush 20 aspirin tablets in a glass container. Add 1 teaspoon of water and work into a paste.

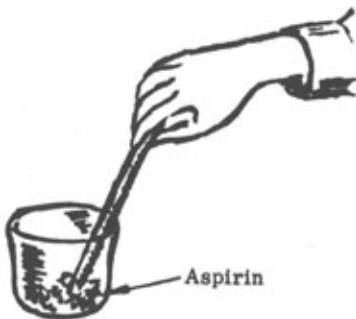

2. Add approximately  $\frac{1}{3}$  to  $\frac{1}{2}$  cup of alcohol (100 milliliters) to the aspirin paste; stir while pouring.



3. Filter the alcohol-aspirin solution through a paper towel into another glass container. Discard the solid left on the paper towel.



4. Pour the filtered solution into a ceramic or glass dish.

5. Evaporate the alcohol and water from the solution by placing the dish into a pan of hot water. White powder will remain in the dish after evaporation.

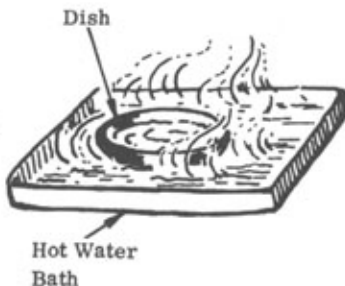

NOTE: Water in pan should be at hot bath temperature, not boiling, approximately  $160^{\circ}$  to  $180^{\circ}$  F. It should not burn the hands.

6. Pour 1/3 cup (80 milliliters) of concentrated sulfuric acid into a canning jar. Add the white powder to the sulfuric acid.

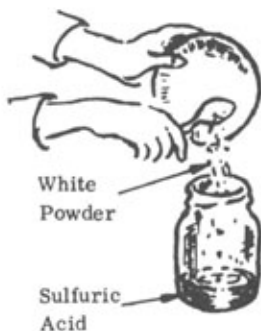

7. Heat canning jar of sulfuric acid in a pan of simmering hot water bath for 15 minutes; then remove jar from the bath. Solution will turn to a yellow-orange color.

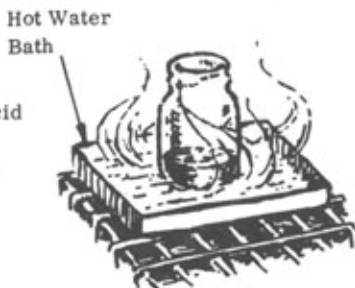

8. Add 3 level teaspoons (15 grams) of potassium nitrate in three portions to the yellow-orange solution; stir vigorously during additions. Solution will turn red, and then back to a yellow-orange color.



9. Allow the solution to cool to ambient or room temperature while stirring occasionally.

10. Slowly pour the solution, while stirring, into 1-1/4 cup (300 milliliters) of cold water and allow to cool.



11. Filter the solution through a paper towel into a glass container. Light yellow particles will collect on the paper towel.

12. Wash the light yellow particles with 2 tablespoons (25 milliliters) of water. Discard the waste liquid in the container.

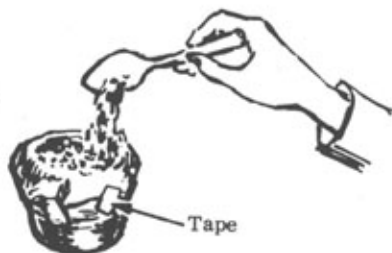

13. Place particles in ceramic dish and set in a hot water bath, as in step 5, for 2 hours.

## DOUBLE SALTS

Double Salts is used as a primary explosive in the fabrication of detonators (Section VI, No. 13). It can be made in the field from silver (coins), nitric acid, calcium carbide, and water.

MATERIALS REQUIRED:

Nitric acid (90% conc.) (Section I, No. 4)  
Silver metal (silver coin, about 5/8 in diameter)  
Calcium carbide (acetylene or calcium carbide lamps)  
Rubber and glass tubing (approx. 1/4 in. inside diameter)  
Paper towels  
Heat-resistant bottles or ceramic jugs, 1 to 2 quart capacity, and one cork to fit. (Punch hole in cork to fit tubing.)  
Teaspoon (aluminum, stainless steel or wax-coated) or equivalent measure  
Glass container  
Heat source  
Long narrow jar (olive jar)  
Tape  
Water  
Alcohol

PROCEDURE:

1. Dilute 2-1/4 teaspoons of nitric acid with 1-1/2 teaspoons of water in a glass container by adding the acid to the water.

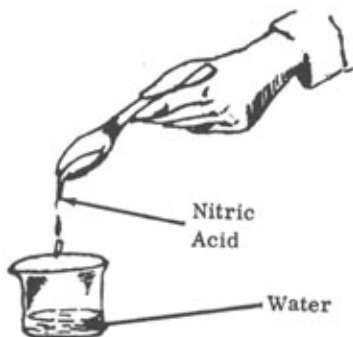

2. Dissolve a silver coin (a silver dime) in the diluted nitric acid. The solution will turn to a green color.

NOTE: It may be necessary to warm the container to completely dissolve the silver coin.

**CAUTION:** Acid will burn skin and destroy clothing. If any is spilled, wash it away with a large quantity of water. Do not inhale fumes.

3. Pour solution into a long narrow (olive) jar and place it in a bottle of hot water. Crystals will form in the solution; heat until crystals dissolve.

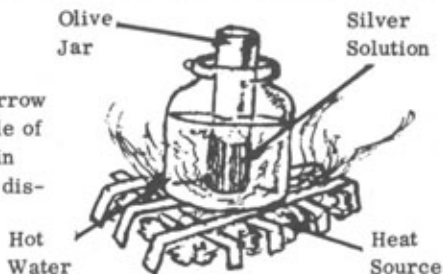

4. While still heating and after crystals have dissolved, place 10 teaspoons of calcium carbide in another glass bottle and add 1 teaspoon of water. After the reaction has started add another teaspoon of water. Then set up as shown.

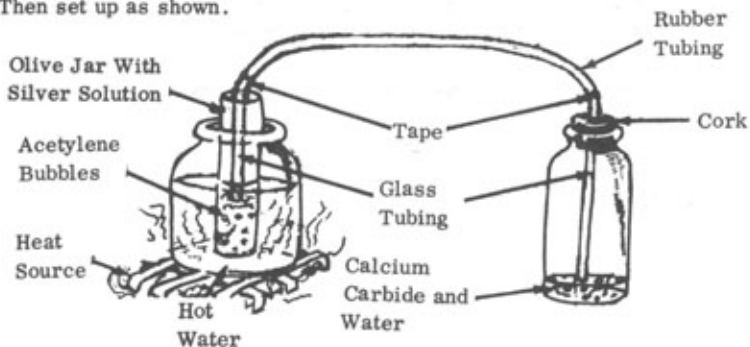

5. Bubble acetylene through the solution for 5 to 8 minutes. A brown vapor will be given off and white flakes will appear in the silver solution.

6. Remove the silver solution from the heat source and allow it to cool. Filter the solution through a paper towel into a glass container. Green crystals will collect on the paper.

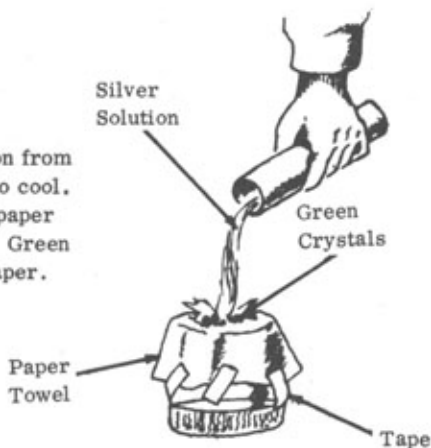



7. Wash the solids collected on the paper towel with 12 teaspoons of alcohol. The solid material will turn white while the solvent in the container will have a green color.

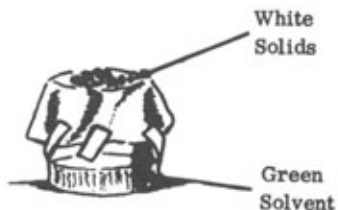

8. Place the white solid material on a clean paper towel to air dry.

**CAUTION: Handle dry explosive with great care. Do not scrape or handle it roughly. Keep away from sparks or open flames. Store in cool, dry place.**

## SODIUM CHLORATE

Sodium chlorate is a strong oxidizer used in the manufacture of explosives. It can be used in place of potassium chlorate (see Section I, No. 1).

MATERIAL REQUIRED:

2 carbon or lead rods (1 in. diameter x 5 in. long)  
Salt or, ocean water  
Sulfuric acid, diluted  
Motor vehicle  
Water  
2 wires, 16 gauge (3/64 in. diameter approx.), 6 ft. long, insulated  
Gasoline  
1 gallon glass jar, wide mouth (5 in. diameter x 6 in. high approx.)  
Sticks  
String  
Teaspoon  
Trays  
Cup  
Heavy cloth  
Knife  
Large flat pan or tray

SOURCES:

Dry cell batteries (2-1/2 in. diameter x 7 in. long) or plumbing supply store  
Grocery store or ocean  
Motor vehicle batteries

PROCEDURE:

1. Mix 1/2 cup of salt into the one gallon glass jar with 3 liters (3 quarts) of water.

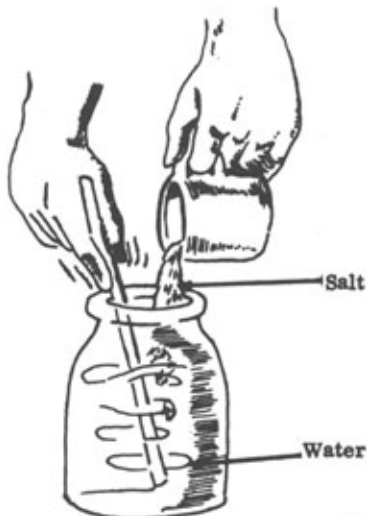

2. Add 2 teaspoons of battery acid to the solution and stir vigorously for 5 minutes.

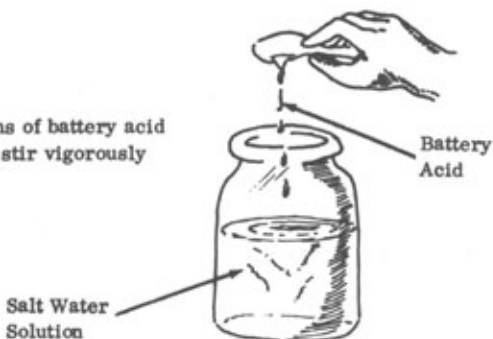

3. Strip about 4 inches of insulation from both ends of the 2 wires.



4. With knife and sticks shape 2 strips of wood 1 x 1/8 x 1-1/2. Tie the wood strips to the lead or carbon rods so that they are 1-1/2 inches apart.

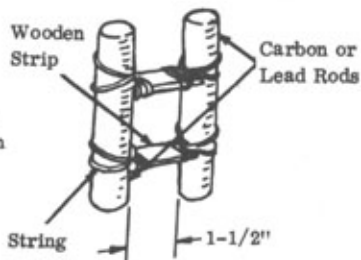

5. Connect the rods to the battery in a motor vehicle with the insulated wire.

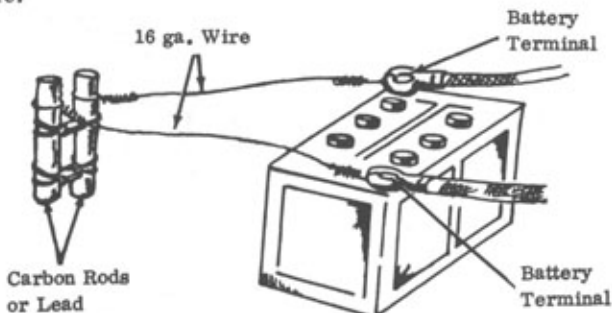

6. Submerge 4-1/2 in. of the rods into the salt water solution.

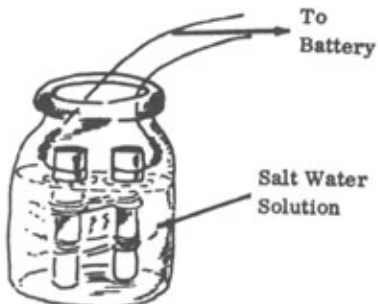

7. With gear in neutral position, start the vehicle engine. Depress the accelerator approximately 1/5 of its full travel.
8. Run the engine with the accelerator in this position for 2 hours; then, shut it down 2 hours.
9. Repeat this cycle for a total of 64 hours while maintaining the level of the acid-salt water solution in the glass jar.

**CAUTION:** This arrangement employs voltages which may be dangerous to personnel. Do not touch bare wire leads while engine is running.

10. Shut off the engine. Remove the rods from the glass jar and disconnect wire leads from the battery.

11. Filter the solution through the heavy cloth into a flat pan or tray, leaving the sediment at the bottom of the glass jar.

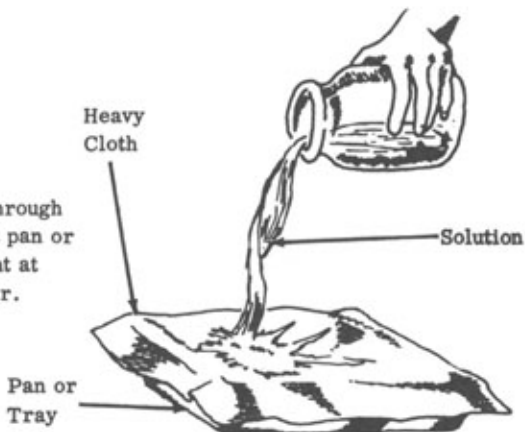

12. Allow the water in the filtered solution to evaporate at room temperature (approx. 16 hours). The residue is approximately 60% or more sodium chlorate which is pure enough to be used as an explosive ingredient.

## MERCURY FULMINATE

Mercury Fulminate is used as a primary explosive in the fabrication of detonators (Section VI, No. 13). It is to be used with a booster explosive such as picric acid (Section I, No. 21) or RDX (Section I, No. 15).

MATERIAL REQUIRED:

Nitric Acid, 90% conc. (1.48  
sp. gr.)  
Mercury  
  
Ethyl (grain) alcohol (90%)  
Filtering material  
Teaspoon measure (1/4, 1/2, and  
1 teaspoon capacity) - aluminum,  
stainless steel or wax-coated  
Heat source  
Clean wooden stick  
Clean water  
Glass containers  
Tape  
Syringe

SOURCE:

Field grade (Section I, No. 4) or  
industrial metal processors  
Thermometers, mercury switches,  
old radio tubes  
  
Paper towels

PROCEDURE:

1. Dilute 5 teaspoons of nitric acid with 2-1/2 teaspoons of clean water in a glass container by adding the acid to the water.

2. Dissolve 1/8 teaspoon of mercury in the diluted nitric acid. This will yield dark red fumes.



NOTE: It may be necessary to add water, one drop at a time, to the mercury-acid solution in order to start reaction.

**CAUTION:** Acid will burn skin and destroy clothing. If any is spilled, wash it away with a large quantity of water. Do not inhale fumes.

3. Warm 10 teaspoons of the alcohol in a container until the alcohol feels warm to the inside of the wrist.

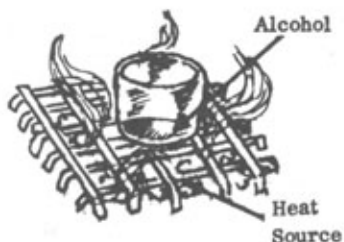

4. Pour the metal-acid solution into the warm alcohol. Reaction should start in less than 5 minutes. Dense white fumes will be given off during reaction. As time lapses, the fumes will become less dense. Allow 10 to 15 minutes to complete reaction. Fulminate will settle to bottom.

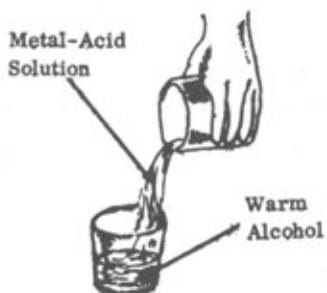

**CAUTION:** This reaction generates large quantities of toxic, flammable fumes. The process must be conducted outdoors or in a well ventilated area, away from sparks or open flames. Do not inhale fumes.

5. Filter the solution through a paper towel into a container. Crystals may stick to the side of the container. If so, tilt and squirt water down the sides of the container until all the material collects on the filter paper.

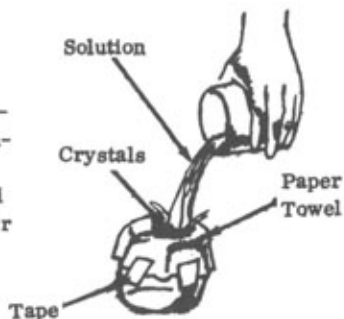

6. Wash the crystals with 6 teaspoons of ethyl alcohol.

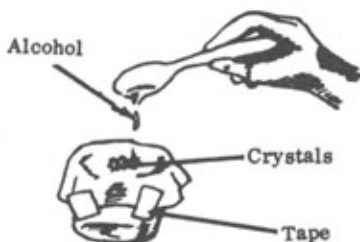

7. Allow these mercury fulminate crystals to air dry.

**CAUTION:** Handle dry explosive with great care. Do not scrape or handle it roughly. Keep away from sparks or open flames. Store in cool, dry place.

## SODIUM CHLORATE AND SUGAR OR ALUMINUM EXPLOSIVE

An explosive munition can be made from sodium chlorate combined with granular sugar, or aluminum powder. This explosive can be detonated with a No. 8 commercial or a Military J-2 blasting cap.

MATERIAL REQUIRED:

Sodium chlorate  
Granular sugar  
Aluminum powder  
Wooden rod or stick  
Bottle or jar  
Blasting cap  
Steel pipe (threaded at one end), end cap  
and tape  
Wax  
Measuring container (cup, quart, etc.)

SOURCE:

Section I, No. 23  
Food store  
Paint store

PROCEDURE:

1. Add three volumes (cups, quarts, etc.) sodium chlorate to one volume aluminum, or two granular sugar, in bottle or jar.

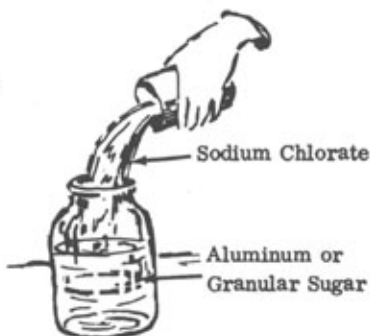

2. Mix ingredients well by stirring with the wooden rod or stick.





HOW TO USE:

1. Wax blasting cap, pipe and end cap.
2. Thread end cap onto pipe.

3. Pour mixture into pipe.



4. Insert and tape blasting cap just beneath surface of mixture.

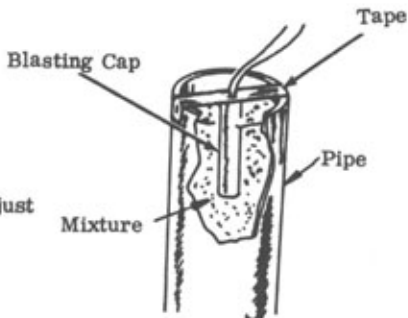

NOTE: Confining the open end of the pipe will add to the effectiveness of the explosive.

### PIPE HAND GRENADE

Hand grenades can be made from a piece of iron pipe. The filler can be plastic or granular military explosive, improvised explosive, or propellant from shotgun or small arms ammunition.

#### MATERIAL REQUIRED

Iron pipe, threaded ends, 1 1/2" to 3" diam., 3" to 8" long.  
Two (2) iron pipe caps.  
Explosive or propellant  
Nonelectric blasting cap.  
(Commercial or military)  
Fuse cord  
Hand drill  
Pliers

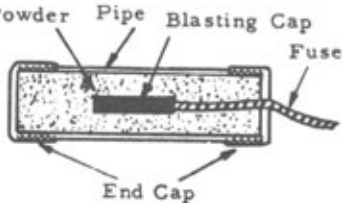

#### PROCEDURE

1. Place blasting cap on one end of fuse cord and crimp with pliers.

NOTE: To find out how long the fuse cord should be, check the time it takes a known length to burn. If 12 inches burns in 30 seconds, a 6-inch cord will ignite the grenade in 15 seconds.

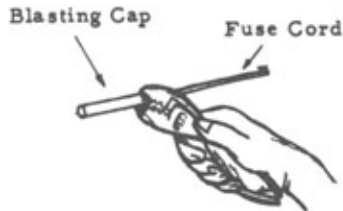

2. Screw pipe cap to one end of pipe. Place fuse cord with blasting cap into the opposite end so that the blasting cap is near the center of the pipe.

NOTE: If plastic explosive is to be used, fill pipe before inserting blasting cap. Push a round stick into the center of the explosive to make a hole and then insert the blasting cap.

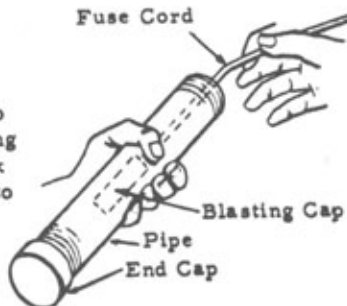

3. Pour explosive or propellant into pipe a little bit at a time. Tap the base of the pipe frequently to settle filler.

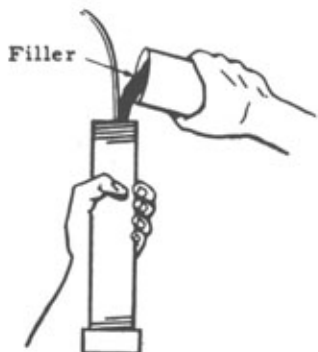

4. Drill a hole in the center of the unassembled pipe cap large enough for the fuse cord to pass through.

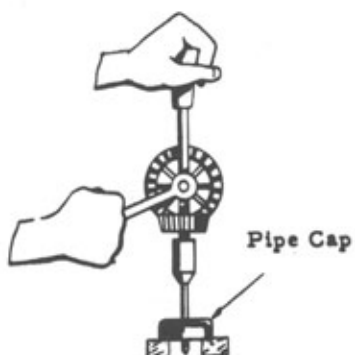

5. Wipe pipe threads to remove any filler material.

Slide the drilled pipe cap over the fuse and screw handtight onto the pipe.

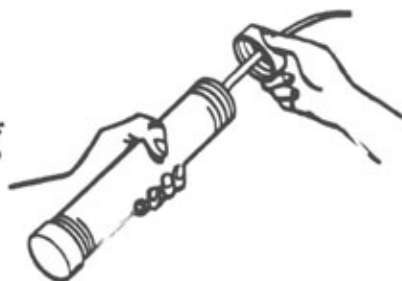

### NAIL GRENADE

Effective fragmentation grenades can be made from a block of TNT or other blasting explosive and nails

#### MATERIAL REQUIRED:

Block of TNT or other blasting explosive  
Nails  
Non-Electric Military blasting cap  
Fuse Cord  
Tape, string, wire or glue

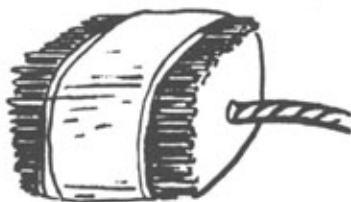

#### PROCEDURE:

1. If an explosive charge other than a standard TNT block is used, make a hole in the center of the charge for inserting the blasting cap. TNT can be drilled with relative safety. With plastic explosives, a hole can be made by pressing a round stick into the center of the charge. The hole should be deep enough that the blasting cap is totally within the explosive.

EXPLOSIVE



HOLE FOR  
BLASTING CAP

2. Tape, tie or glue one or two rows of closely packed nails to sides of explosive block. Nails should completely cover the four surfaces of the block.



3. Place blasting cap on one end of the fuse cord and crimp with pliers.

BLASTING CAP FUSE CORD



**NOTE:** To find out how long the fuse cord should be, check the time it takes a known length to burn. If 12 inches (30 cm) burns for 30 seconds, a 10 second delay will require a 4 inch (10 cm) fuse.

4. Insert the blasting cap in the hole in the block of explosive. Tape or tie the fuse cord securely in place so that it will not fall out when the grenade is thrown.

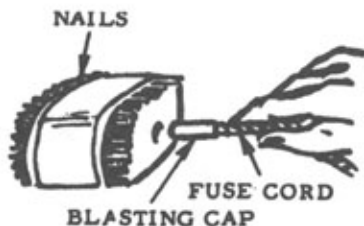

ALTERNATE USE:

An effective directional anti-personnel mine can be made by placing nails on only one side of the explosive block. For this case, an electric blasting cap can be used.



### WINE BOTTLE CONE CHARGE

This cone charge will penetrate 3 to 4 inches of armor. Placed on an engine or engine compartment it will disable a tank or other vehicle.

#### MATERIAL REQUIRED:

Glass wine bottle with false bottom (cone shaped)  
Plastic or castable explosive  
Blasting cap  
Gasoline or Kerosene (small amount)  
String  
Adhesive tape



#### PROCEDURE:

1. Soak a piece of string in gasoline or kerosene. Double wrap this string around the wine bottle approximately 3 in. (7 1/2 cm) above the top of the cone.

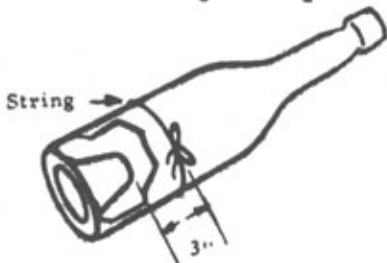

NOTE: A small amount of motor oil added to the gasoline or kerosene will improve results.

2. Ignite the string and allow to burn for 1 to 2 minutes. Then plunge the bottle into cold water to crack the bottle. The top half can now be easily removed and discarded.

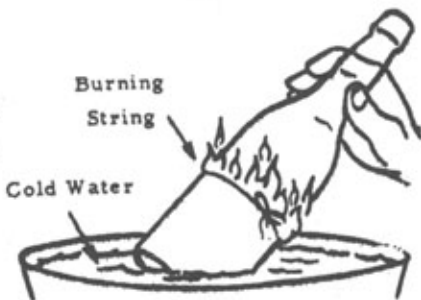

3. If plastic explosive is used:  
(a) pack explosive into the bottle a little at a time compressing with a wooden rod. Fill the bottle to the top.

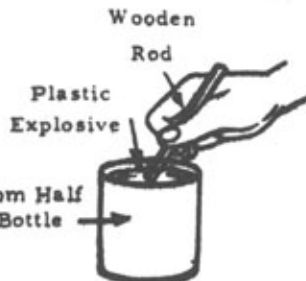

(b) press a 1/4 in. wooden dowel 1/2 in. (12mm) into the middle of the top of the explosive charge to form a hole for the blasting cap.

4. If TNT or other castable explosive is used:  
(a) break explosive into small pieces using a wooden mallet or non-sparking metal tools. Place pieces in a tin can.

(b) Suspend this can in a larger container which is partly filled with water. A stiff wire or stick pushed through the smaller can will accomplish this.

**CAUTION:** The inner can must not rest on the bottom of the outer container.

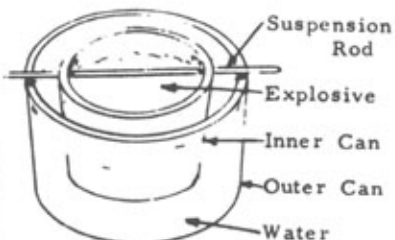

(c) Heat the container on an electric hot plate or other heat source. Stir the explosive frequently with a wooden stick while it is melting.

**CAUTION:** Keep area well ventilated while melting explosive. Fumes may be poisonous.

(d) When all the explosive has melted, remove the inner container and stir the molten explosive until it begins to thicken. During this time the bottom half of the wine bottle should be placed in the container of hot water. This will pre-heat the bottle so that it will not crack when the explosive is poured.

(e) Remove the bottle from hot water and dry thoroughly. Pour molten explosive into the bottle and allow to cool. The crust which forms on top of the charge during cooling should be broken with a wooden stick and more explosive added. Do this as often as necessary until the bottle is filled to the top.

(f) When explosive has completely hardened, bore a hole for the blasting cap in the middle of the top of the charge about 1/2 in. (12mm) deep.

#### HOW TO USE:

1. Place blasting cap in the hole in the top of the charge. If non-electric cap is used be sure cap is crimped around fuze and fuze is long enough to provide safe delay.



2. Place the charge so that the bottom is 3 to 4 in. (7 1/2 to 10 cm) from the target. This can be done by taping legs to the charge or any other convenient means as long as there is nothing between the base of the charge and the target.

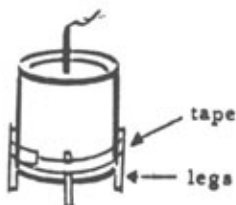

3. If electric cap is used, connect blasting cap wires to firing circuit.

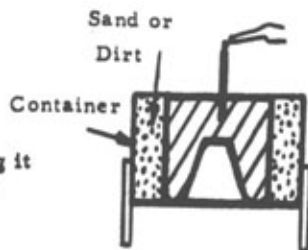

**NOTE:** The effectiveness of this charge can be increased by placing it inside a can, box, or similar container and packing sand or dirt between the charge and the container.

### GRENADÉ-TIN CAN LAND MINE

This device can be used as a land mine that will explode when the trip wire is pulled.

#### MATERIAL REQUIRED:

Hand grenade having side safety lever

Sturdy container, open at one end, that is just large enough to fit over grenade and its safety lever (tin can of proper size is suitable).

Strong string or wire

NOTE: The container must be of such a size that, when the grenade is placed in it and the safety pin removed, its sides will prevent the safety lever from springing open. One end must be completely open.

#### PROCEDURE:

1. Fasten one piece of string to the closed end of container, making a strong connection. This can be done by punching 2 holes in the can, looping the string through them, and tying a knot.



2. Tie free end of this string to bush, stake, fencepost, etc.

3. Fasten another length of string to the grenade such that it cannot interfere with the functioning of the ignition mechanism of the grenade.



4. Insert grenade into container.





5. Lay free length of string across path and fasten to stake, bush, etc. The string should remain taut.

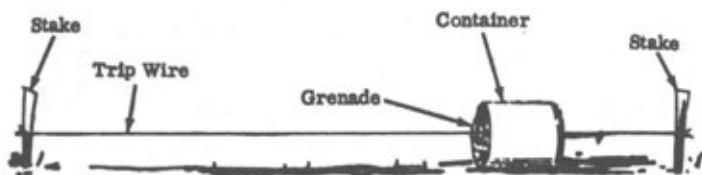

HOW TO USE:

1. Carefully withdraw safety pin by pulling on ring. Be sure safety lever is restrained during this operation. Grenade will function in normal manner when trip wire is pulled.

NOTE: In areas where concealment is possible, a greater effect may be obtained by suspending the grenade several feet above ground, as illustrated below.

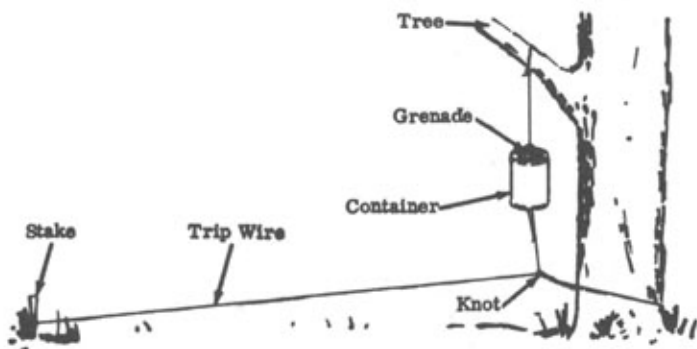

## MORTAR SCRAP MINE

A directional shrapnel launcher that can be placed in the path of advancing troops.

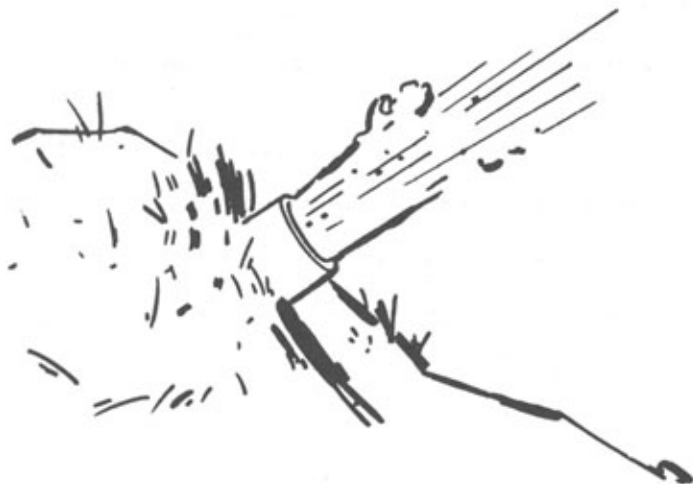
MATERIAL REQUIRED:

Iron pipe approximately 3 ft. (1 meter) long and 2 in. to 4 in. (5 to 10 cm) in diameter and threaded on at least one end. Salvaged artillery cartridge case may also be used.

Threaded cap to fit pipe.

Black powder or salvaged artillery propellant about 1/2 lb. (200 gms) total.

Electrical igniter (commercial SQUIB or improvised igniter, Section VI, No. 1). Safety or improvised fuse may also be used.

Small stones about 1 in. (2-1/2 cm) in diameter or small size scrap; about 1 lb. (400 gms) total.

Rags for wadding, each about 20 in. by 20 in. (50 cm x 50 cm)

Paper or bag

Battery and wire

Stick (non-metallic)

Note: Be sure pipe has no cracks or flaws.

PROCEDURE:

1. Screw threaded cap onto pipe.
2. Place propellant and igniter in paper or rag and tie package with string so contents will not fall out.

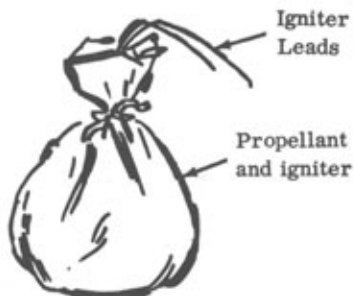

3. Insert packaged propellant and igniter into pipe until package rests against threaded cap leaving firing leads extending from open end of pipe.
4. Roll rag till it is about 6 in. (15-1/2 cm) long and the same diameter as pipe. Insert rag wadding against packaged propellant igniter. With caution, pack tightly using stick.
5. Insert stones and/or scrap metal into pipe.
6. Insert second piece of rag wadding against stones and/or metal scrap. Pack tightly as before.

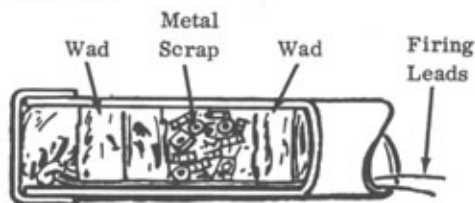
HOW TO USE:

1. Bury pipe in ground with open end facing the expected path of the enemy. The open end may be covered with cardboard and a thin layer of dirt or leaves as camouflage.



2. Connect firing leads to battery and switch. Mine can be remotely fired when needed or attached to trip device placed in path of advancing troops.

NOTE: A NON-ELECTRICAL ignition system can be substituted for the electrical ignition system as follows.

1. Follow above procedure, substituting safety fuse for igniter.
2. Light safety fuse when ready to fire.

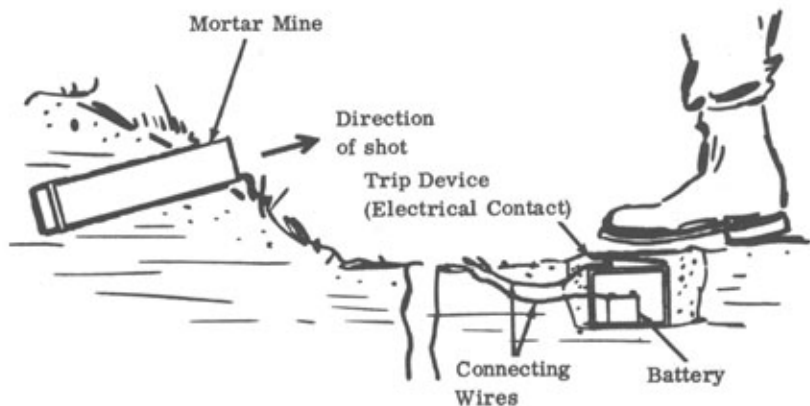

## COKE BOTTLE SHAPED CHARGE

This shaped charge will penetrate 3 in. (7-1/2 cm) of armor. (It will disable a vehicle if placed on the engine or engine compartment).

MATERIAL REQUIRED:

Glass Coke bottle, 6-1/2 oz. size

Plastic or castable explosive, about  
1 lb. (454 gm)

Blasting cap

Metal cylinder, open at both ends, about  
6 in. (15 cm) long and 2 in. (5 cm) inside  
diameter. Cylinder should be heavy  
walled for best results.

Plug to fit mouth of coke bottle  
(rags, metal, wood, paper, etc.)

Non-metal rod about 1/4 in. (6 mm) in  
diameter and 8 in. (20 cm) or more  
in length.

Tape or string

2 tin cans if castable explosive is used (See Section II, No. 3)

NOTE: Cylinder may be cardboard, plastic, etc. if castable explosive is used.

PROCEDURE:

1. Place plug in mouth of bottle.

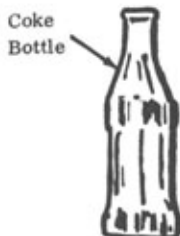

2. Place cylinder over top of bottle until bottom of cylinder rests on widest part of bottle. Tape cylinder to bottle. Container should be straight on top of bottle.

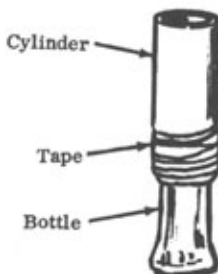

## 3. If plastic explosive is used:

- a. Place explosive in cylinder a little at a time tamping with rod until cylinder is full.



- b. Press the rod about 1/2 in. (1 cm) into the middle of the top of the explosive charge to form a hole for the blasting cap.

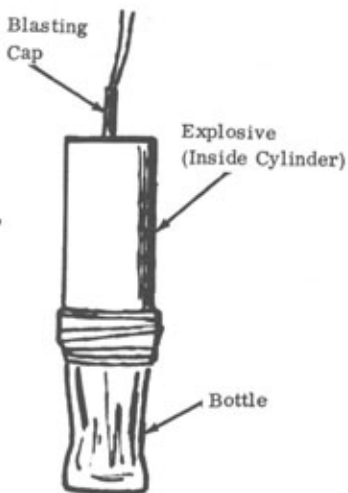

4. If castable explosive is used, follow procedure of Wine Bottle Cone Charge, Section II, No. 3, Step 4, a through f.

HOW TO USE:Method 1. If electrical blasting cap is used:

1. Place blasting cap in hole in top of explosive.

**CAUTION:** Do not insert blasting cap until charge is ready to be detonated.

2. Place bottom of Coke Bottle flush against the target. If target is not flat and horizontal, fasten bottle to target by any convenient means, such as by placing tape or string around target and top of bottle. Bottom of bottle acts as stand-off.

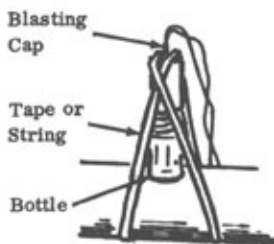

**CAUTION:** Be sure that base of bottle is flush against target and that there is nothing between the target and the base of the bottle.

3. Connect leads from blasting cap to firing circuit.

Method II: If non-electrical blasting cap is used:

1. Crimp cap around fuse.

**CAUTION:** Be sure fuse is long enough to provide a safe delay.

2. Follow steps 1, 2, and CAUTIONS of Method I.

3. Light fuse when ready to fire.

CYLINDRICAL CAVITY SHAPED CHARGE

A shaped charge can be made from common pipe. It will penetrate 1-1/2 in. (3-1/2 cm) of steel, producing a hole 1-1/2 in. (3-1/2 cm) in diameter.

MATERIAL REQUIRED:

Iron or steel pipe, 2 to 2-1/2 in. (5 to 6-1/2 cm) in diameter and 3 to 4 in. (7-1/2 to 10 cm) long

Metal pipe, 1/2 to 3/4 in. (1-1/2 to 2 cm) in diameter and 1-1/2 in. (3-1/2 cm) long, open at both ends. (The wall of the pipe should be as thin as possible.)

Blasting cap

Non-metallic rod, 1/4 in. (6 mm) in diameter

Plastic or castable explosive

2 metal cans of different sizes

Stick or wire

Heat source

} If castable explosive is used

PROCEDURE:

1. If plastic explosive is used:

- a. Place larger pipe on flat surface. Hand pack and tamp explosive into pipe. Leave approximately 1/4 in. (6 mm) space at top.

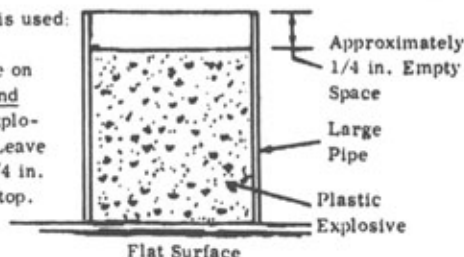

- b. Push rod into center of explosive. Enlarge hole in explosive to diameter and length of small pipe.

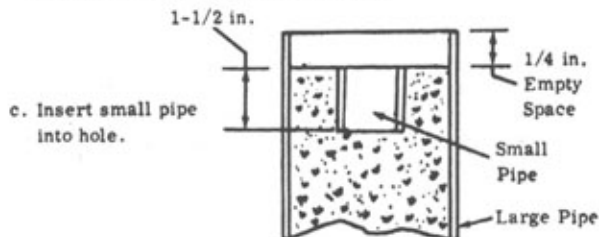

- c. Insert small pipe into hole.

**IMPORTANT:** Be sure direct contact is made between explosive and small pipe. Tamp explosive around pipe by hand if necessary.



- d. Make sure that there is 1/4 in. (6 mm) empty space above small pipe. Remove explosive if necessary.

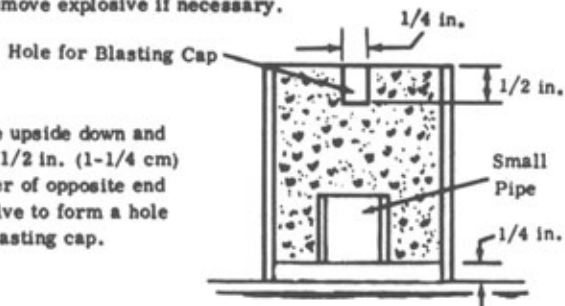

- e. Turn pipe upside down and push rod 1/2 in. (1-1/4 cm) into center of opposite end of explosive to form a hole for the blasting cap.

**CAUTION:** Do not insert blasting cap in hole until ready to fire shaped charge.

2. If TNT or other castable explosive is used:

- a. Follow procedure, Section II, No. 3, Step 4, Parts a, b, c, including CAUTIONS.
- b. When all the explosive has melted, remove the inner container and stir the molten explosive until it begins to thicken.

- c. Place large pipe on flat surface. Pour explosive into pipe until it is 1-3/4 in. (4 cm) from the top.

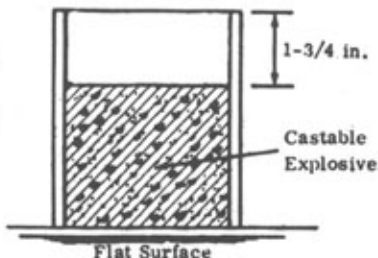

- d. Place small pipe in center of large pipe so that it rests on top of explosive. Holding small pipe in place, pour explosive around small pipe until explosive is 1/4 in. (6 mm) from top of large pipe.

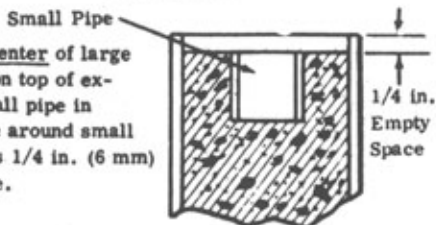

- e. Allow explosive to cool. Break crust that forms on top of the charge during cooling with a wooden stick and add more explosive. Do this as often as necessary until explosive is 1/4 in. (6 mm) from top.

- f. When explosive has completely hardened, turn pipe upside down and bore a hole for the blasting cap in the middle of the top of the charge about 1/2 in. (1-1/4 cm) deep.

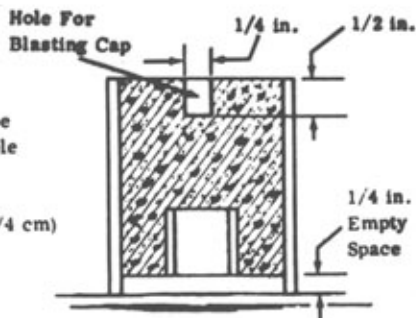

**HOW TO USE:**

**Method I -** If electrical blasting cap is used:

1. Place blasting cap in hole made for it.

**CAUTION:** Do not insert blasting cap until charge is ready to fire.

2. Place other end of pipe flush against the target. Fasten pipe to target by any convenient means, such as by placing tape or string around target and top of pipe, if target is not flat and horizontal.

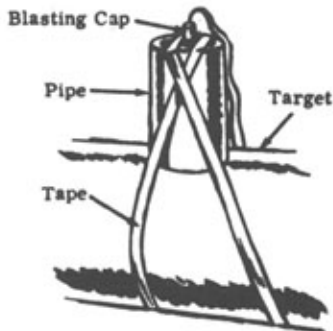

**CAUTION:** Be sure that base of pipe is flush against target and that there is nothing between the target and the base of the pipe.

3. Connect leads from blasting cap to firing circuit.

**Method II -** If non-electrical blasting cap is used:

1. Crimp cap around fuse.

**CAUTION:** Be sure fuse is long enough to provide a safe delay.

2. Follow Steps 1, 2, and CAUTION of Method I.
3. Light fuse when ready to fire.

## UNLINED CYLINDRICAL CAVITY SHAPED CHARGE

A modified shaped charge can be made from common pipe. It will penetrate 1 in. (2-1/2 cm) of steel, producing a hole 1-1/2 to 1-3/4 in. (3-1/2 to 4 cm) in diameter.

MATERIAL REQUIRED:

Iron or steel pipe, 2 to 2-1/2 in. (5 to 6-1/2 cm) in diameter and  
3 to 4 in. (7-1/2 to 10 cm) long

Blasting cap

Non-metallic rod (plastic, wood, cardboard, etc.), 1/4 in. (6 mm)  
in diameter

Plastic or castable explosive

Non-metallic rod or tube, at least 1-3/4 in. (4 cm) long and 1/2 to 3/4  
in. (12 to 19 mm) in diameter

2 metal cans of different sizes

Stick or wire

Heat source

} If castable explosive is used

PROCEDURE:

1. If plastic explosive is used:

- a. Place pipe on flat surface. Hand pack and tamp explosive into pipe. Leave approximately 1/2 in. (1-1/4 cm) space at top.

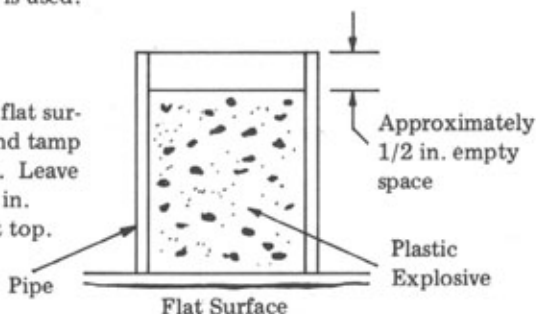

- b. Push rod into center of explosive. Enlarge hole to 1-1/4 in. (3-1/4 cm) in diameter. Leave 1/4 in. (6 mm) space at top. Remove explosive if necessary.

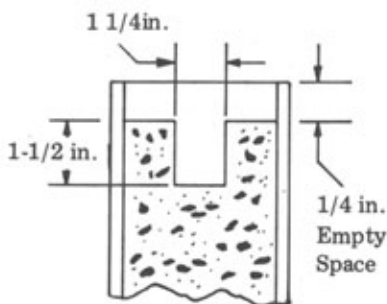

- c. Turn pipe upside down and push 1/4 in. (6 mm) diameter rod 1/2 in. (1-1/4 cm) into center of opposite end of explosive to form a hole for the blasting cap.

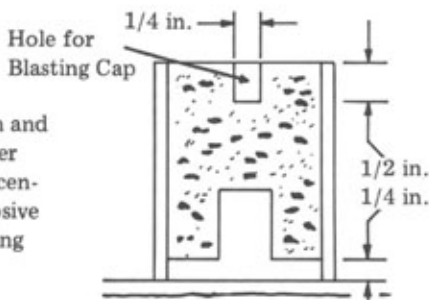

**CAUTION:** Do not insert blasting cap until ready to fire shaped charge.

2. If TNT or other castable explosive is used:
- Follow procedure, Section II, No. 3, Step 4, Parts a, b, c, including CAUTIONS.
  - When all the explosive has melted, remove the inner container and stir the molten explosive until it began to thicken.

- c. Place pipe on flat surface. Pour explosive into pipe until explosive is 1-3/4 in. (4 cm) from top.

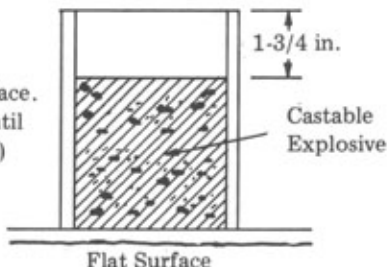

- d. Place larger rod or tube in center of pipe so that it rests on top of explosive. Hold rod or tube in place, and pour explosive into pipe around it until explosive is 1/4 in. (6 mm) from top. If rod is used, remove before explosive hardens completely. However, tube may be left in hardened explosive.

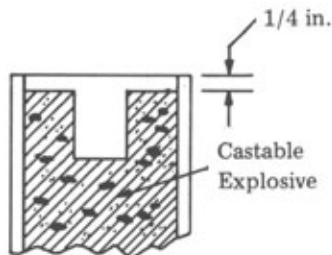

- e. Allow explosive to cool. Break crust that forms on top of the charge during cooling with a wooden stick and add more explosive. Do this as often as necessary until explosive is 1/4 in. (6 mm) from top.

FOR OFFICIAL USE ONLY

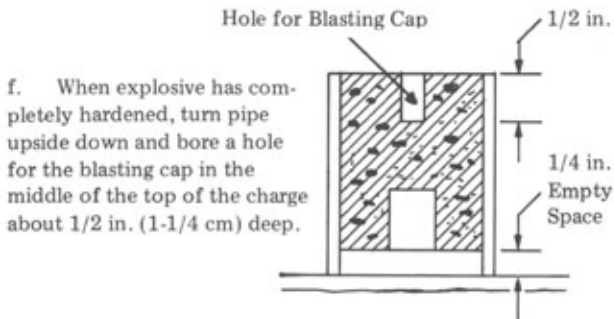

HOW TO USE:

Method I - If electrical blasting cap is used:

1. Place blasting cap in hole made for it.

**CAUTION:** Do not insert blasting cap until charge is ready to fire.

2. Place other end of pipe flush against the target. Fasten pipe to target by any convenient means, such as by placing tape or string around target and top of pipe, if target is not flat and horizontal.

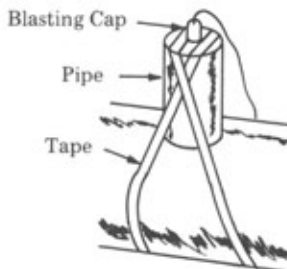

**CAUTION:** Be sure that base of pipe is flush against target and that there is nothing between the target and the base of the pipe.

3. Connect leads from blasting cap to firing circuit.

Method II - If non-electrical blasting cap is used:

1. Crimp cap around fuse.

**CAUTION:** Be sure fuse is long enough to provide a safe delay.

2. Follow Steps 1, 2, and CAUTION of Method I.
3. Light fuse when ready to fire.

## FUNNEL SHAPED CHARGE

An effective shaped charge can be made using various types of commercial funnels. See table for penetration capabilities.

MATERIAL REQUIRED:

Container (soda or beer can, etc.), approximately 2-1/2 in. diameter x 5 in. long (6-1/4 cm x 12-1/2 cm)

Funnel(s) (glass, steel, or aluminum) 2-1/2 in. (6-1/2 cm) in diameter

Wooden rod or stick, 1/4 in. (6 mm) in diameter

Tape

Blasting cap (electrical or non-electrical)

Sharp cutting edge

Explosive

PROCEDURE:

1. Remove the top and bottom from can and discard.

2. Cut off and throw away the spout of the funnel(s).

NOTE: When using 3 funnels (see table), place the modified funnels together as tight and as straight as possible. Tape the funnels together at the outer ridges.

3. Place the funnel(s) in the modified can. Tape on outer ridges to hold funnel(s) to can.

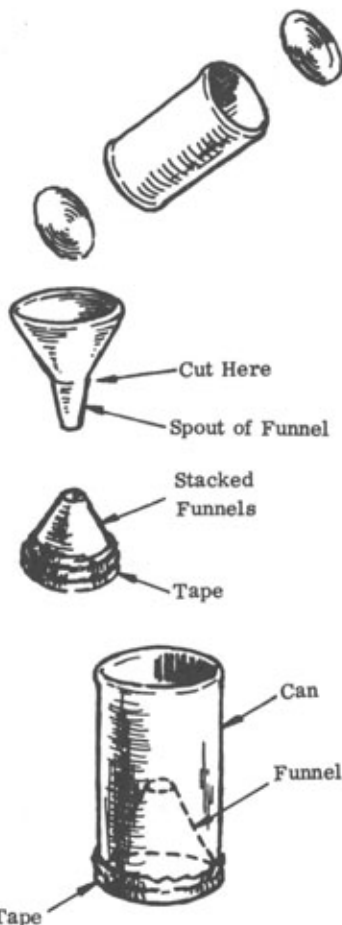

4. If plastic explosive is used, fill the can with the explosive using small quantities, and tamp with wooden rod or stick.



NOTE: If castable explosive is used, refer to step 4 of Section II, No. 3.

5. Cut wooden rod to lengths 3 inches longer than the standoff length. (See table.) Position three of these rods around the explosive filled can and hold in place with tape.

NOTE: The position of the rods on the container must conform to standoff dimensions to obtain the penetrations given in the table.

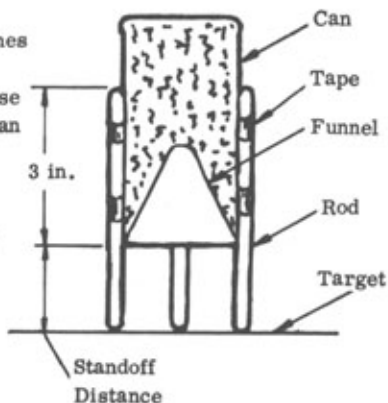

Table

Funnel Material	No. of Funnels	Standoff		Penetration	
		inches	metric	inches	metric
Glass	1	5 - 1/2	9 cm	4	10 cm
Steel	3	1	2-1/2 cm	2-1/2	6 cm
Aluminum	3	3-1/2	9 cm	2-1/2	6 cm
*If only one steel or aluminum funnel is available:					
Steel	1	1	2-1/2 cm	1-1/2	4 cm
Aluminum	1	1	2-1/2 cm	1-1/2	4 cm

6. Make a hole for blasting cap in the center of the explosive with rod or stick.



**CAUTION:** Do not place blasting cap in place until the Funnel Shaped Charge is ready for use.

HOW TO USE:

1. Place blasting cap in the hole in top of the charge. If non-electric cap is used, be sure cap is crimped around fuse and fuse is long enough to provide safe delay.

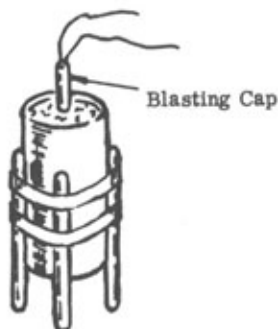

2. Place (tape if necessary) the Funnel Shaped Charge on the target so so that nothing is between the base of charge and target.
3. If electric cap is used, connect blasting cap wires to firing circuit.



## LINEAR SHAPED CHARGE

This shaped charge made from construction materials will cut through up to nearly 3 inches of armor depending upon the liner used (see table).

MATERIAL REQUIRED:

Standard structural angle or pipe (see table)

Wood or cardboard container

Hacksaw } if pipe is used  
Vice }

Wooden rod, 1/4 in. (6 mm) diameter

Explosive

Blasting cap

Tape

Table

Type	Material	Liner Size in. - Nom.	Standoff		Penetration	
			in.	metric	in.	metric
angle	steel	3 x 3 legs x 1/4 web	2	5 cm	2-3/4	7 cm
angle	aluminum	2 x 2 legs x 3/16 web	5-1/2	14 cm	2-1/2	6 cm
pipe half section	aluminum	2 diameter	2	5 cm	2	5 cm
pipe half section	copper	2 diameter	1	2-1/2 cm	1-3/4	4 cm

NOTE: These were the only linear shaped charges of this type that were found to be more efficient than the Ribbon Charge.

Ribbon Charge: No standoff is required; just place on target.

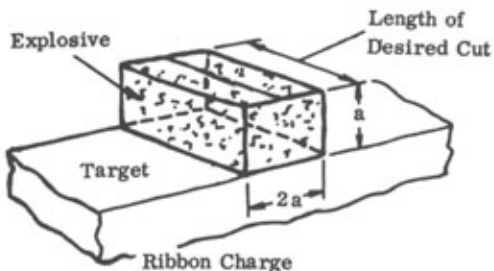

PROCEDURE:

1. If pipe is used --
  - a. Place the pipe in the vise and cut pipe in half lengthwise. Remove the pipe half sections from vise.
  - b. Discard one of the pipe half sections, or save for another charge.



2. Place angle or pipe half section with open end face down on a flat surface.
3. Make container from any material available. The container must be as wide as the angle or pipe half section, twice as high, and as long as the desired cut to be made with the charge.
4. Place container over the liner (angle or pipe half section) and tape liner to container.

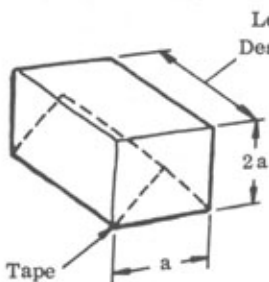

Container with  
Pipe Half Section

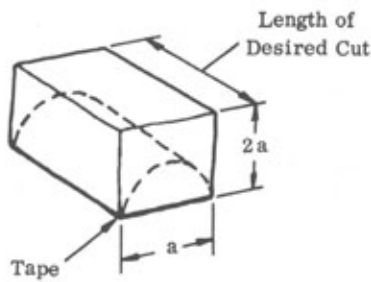

Container with  
Angle

5. If plastic explosive is used, fill the container with the explosive using small quantities, and tamp with wooden rod or stick.

NOTE: If castable explosive is used, refer to step 4 of Section II, No. 3.

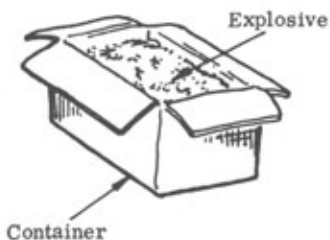

FOR OFFICIAL USE ONLY

6. Cut wooden rod to lengths 2 inches longer than the standoff length (see table). Position the rods at the corners of the explosive filled container and hold in place with tape.

NOTE: The position of the rods on the container must conform to standoff and penetration dimensions given in the table.

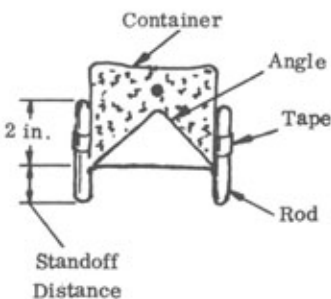

7. Make a hole for blasting cap in the side of the container 1/2 in. above the liner and centered with the wooden rod.

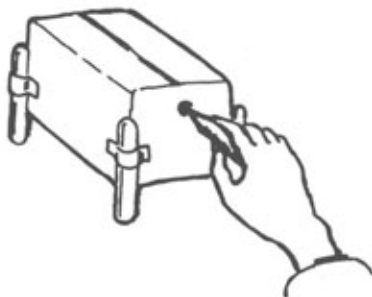

**CAUTION:** Do not place blasting cap in place until the Linear Shaped Charge is ready for use.

HOW TO USE:

1. Place blasting cap into hole on the side of the container. If non-electric cap is used, be sure cap is crimped around fuse and fuse is long enough to provide safe delay.

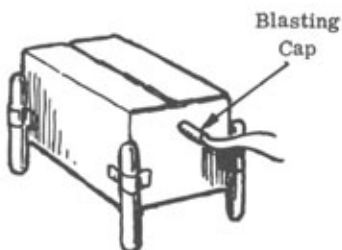

2. Place (tape if necessary) the Linear Shaped Charge on the target so that nothing is between base of charge and target.

3. If electric cap is used, connect blasting cap wires to firing circuit.

## PIPE PISTOL FOR 9 MM AMMUNITION

A 9 mm pistol can be made from 1/4" steel gas or water pipe and fittings.

MATERIAL REQUIRED

1/4" nominal size steel pipe 4 to 6 inches long with threaded ends.

1/4" Solid pipe plug

Two (2) steel pipe couplings

Metal strap - roughly 1/8" x 1/4" x 5"

Two (2) elastic bands

Flat head nail - 6D or 8D (approx 1/16" diameter)

Two (2) wood screws #8

Wood 8" x 5" x 1"

Drill

1/4" wood or metal rod, (approx 8" long)

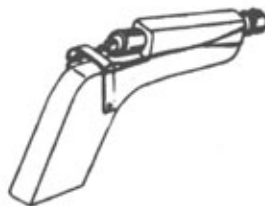
PROCEDURE

1. Carefully inspect pipe and fittings.

- a. Make sure that there are NO cracks or other flaws in the pipe or fittings.
- b. Check inside diameter of pipe using a 9 mm cartridge as a gauge. The bullet should closely fit into the pipe without forcing but the cartridge case SHOULD NOT fit into pipe.
- c. Outside diameter of pipe MUST NOT BE less than 1 1/2 times bullet diameter (.536 inches; 1.37 cm)

2. Drill a 9/16" (1.43 cm) diameter hole 3/8" (approximately 1 cm) into one coupling to remove the thread.

Drilled section should fit tightly over smooth section of pipe.

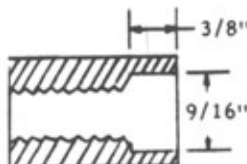

3. Drill a 25/64" (1 cm) diameter hole 3/4" (1.9 cm) into pipe. Use cartridge as a gauge; when a cartridge is inserted into the pipe, the base of the case should be even with the end of the pipe. Thread coupling tightly onto pipe, drilled end first.

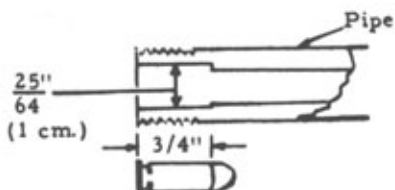

4. Drill a hole in the center of the pipe plug just large enough for the nail to fit through.

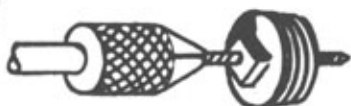

**HOLE MUST BE CENTERED  
IN PLUG.**

5. Push nail through plug until head of nail is flush with square end. Cut nail off at other end  $1/16''$  (.158 cm) away from plug. Round off end of nail with file.

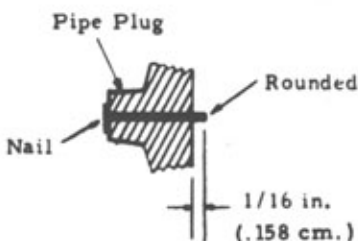

6. Bend metal strap to "U" shape and drill holes for wood screws. File two small notches at top.

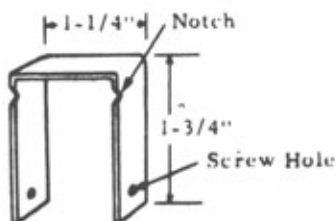

7. Saw or otherwise shape  $1''$  (2.54 cm) thick hard wood into stock.

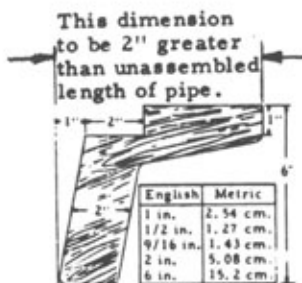

8. Drill a  $9/16''$  diameter (1.43 cm) hole through the stock. The center of the hole should be approximately  $1/2''$  (1.27 cm) from the top.

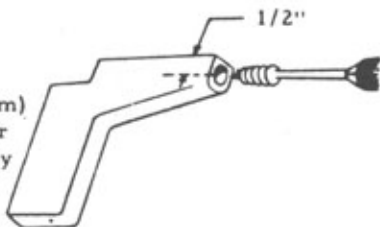

9. Slide the pipe through this hole and attach front coupling. Screw drilled pipe into rear coupling.

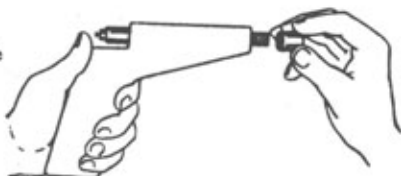

NOTE: If 9/16" drill is not available cut a "V" groove in the top of the stock and tape pipe securely in place.

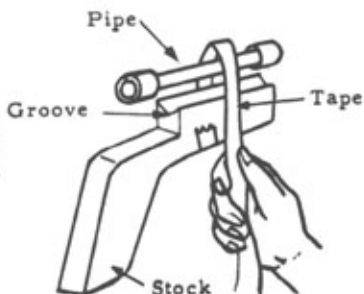

10. Position metal strap on stock so that top will hit the head of the nail. Attach to stock with wood screw on each side.

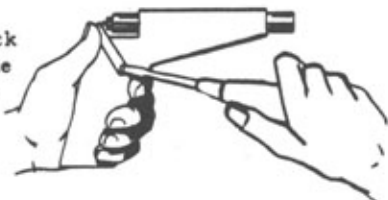

11. String elastic bands from front coupling to notch on each side of the strap.

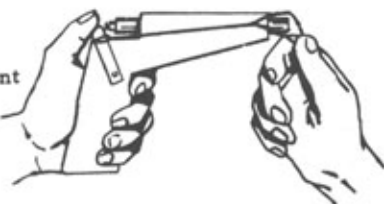

#### SAFETY CHECK - TEST FIRE PISTOL BEFORE HAND FIRING

1. Locate a barrier such as a stone wall or large tree which you can stand behind in case the pistol ruptures when fired.
2. Mount pistol solidly to a table or other rigid support at least ten feet in front of the barrier.
3. Attach a cord to the firing strap on the pistol.
4. Holding the other end of the cord, go behind the barrier.
5. Pull the cord so that the firing strap is held back.
6. Release the cord to fire the pistol. (If pistol does not fire, shorten the elastic bands or increase their number.)

**IMPORTANT:** Fire at least five rounds from behind the barrier and then re-inspect the pistol before you attempt to hand fire it.

## HOW TO OPERATE PISTOL

### 1. To Load

- a. Remove plug from rear coupling.



- b. Place cartridge into pipe.



- c. Replace plug.

### 2. To Fire

- a. Pull strap back and hold with thumb until ready.
- b. Release strap.



### 3. To Remove Shell Case

- a. Remove plug from rear coupling.
- b. Insert 1/4" diameter steel or wooden rod into front of pistol and push shell case out.



### SHOTGUN (12 GAUGE)

A 12-gauge shotgun can be made from 3/4" water or gas pipe and fittings.

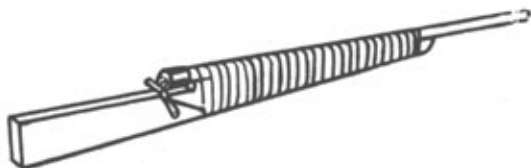

#### MATERIALS REQUIRED

- Wood 2" x 4" x 32"
- 3/4" nominal size water or gas pipe 20" to 30" long threaded on one end.
- 3/4" steel coupling
- Solid 3/4" pipe plug
- Metel strap (1/4" x 1/16" x 4")
- Twine, heavy (100 yards approximately)
- 3 wood screws and screwdriver
- Flat head nail 6D or 8D
- Hand drill
- Saw or knife
- File
- Shellac or lacquer
- Elastic Bands

#### PROCEDURE

1. Carefully inspect pipe and fittings.
  - a. Make sure that there are no cracks or other flaws.
  - b. Check inside diameter of pipe. A 12-gauge shot shell should fit into the pipe but the brass rim should not fit.
  - c. Outside diameter of pipe must be at least 1 in. (2.54 cm).

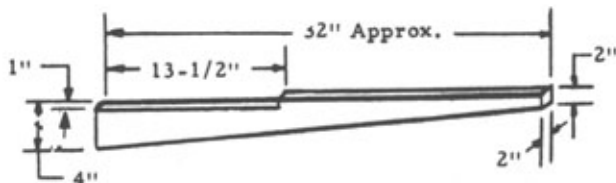

2. Cut stock from wood using a saw or knife.



3. Cut a 3/8" deep "V" groove in top of the stock.



4. Turn coupling onto pipe until tight.

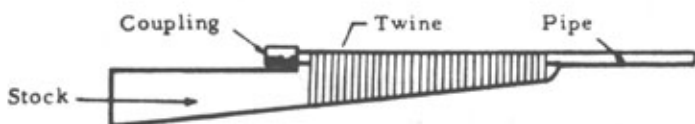

5. Coat pipe and "V" groove of stock with shellac or lacquer and, while still wet, place pipe in "V" groove and wrap pipe and stock together using two heavy layers of twine. Coat twine with shellac or lacquer after each layer.

6. Drill a hole through center of pipe plug large enough for nail to pass through.

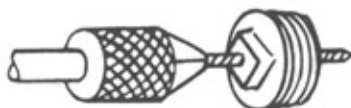

7. File threaded end of plug flat.



8. Push nail through plug and cut off flat  $1/32$ " past the plug.

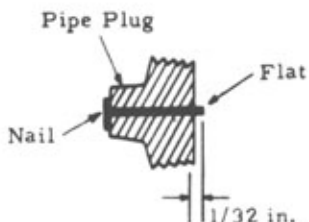

9. Screw plug into coupling.

10. Bend 4" metal strap into "L" shape and drill hole for wood screw. Notch metal strap on the long side  $1/2$ " from bend.

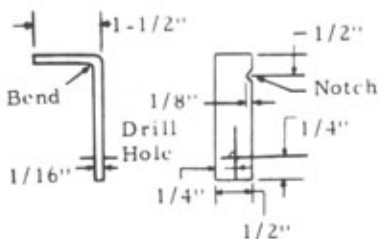

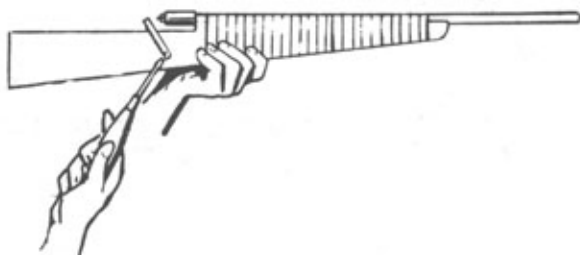

11. Position metal strap on stock so that top will hit the head of the nail. Attach to stock with wood screw.

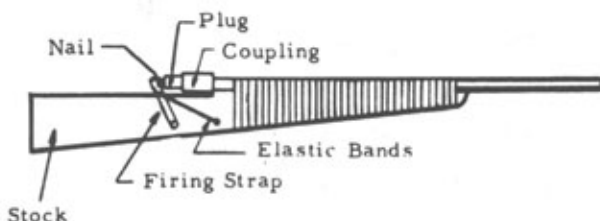

12. Place screw in each side of stock about 4" in front of metal strap. Pass elastic bands through notch in metal strap and attach to screw on each side of the stock.

#### SAFETY CHECK - TEST FIRE SHOTGUN BEFORE HAND FIRING

1. Locate a barrier such as a stone wall or large tree which you can stand behind in case the weapon explodes when fired.
2. Mount shotgun solidly to a table or other rigid support at least ten feet in front of the barrier.
3. Attach a long cord to the firing strap on the shotgun.
4. Holding the other end of the cord, go behind the barrier.
5. Pull the cord so that the firing strap is held back.
6. Release the cord to fire the shotgun. (If shotgun does not fire, shorten the elastic bands or increase their number.)

**IMPORTANT:** Fire at least five rounds from behind the barrier and then re-inspect the shotgun before you attempt to shoulder fire it.

## HOW TO OPERATE SHOTGUN

### 1. To Load



- a. Take plug out of coupling.



- b. Put shotgun shell into pipe.  
c. Screw plug hand-tight into coupling.

### 2. To Fire



- a. Pull strap back and hold with thumb.  
b. Release strap.

### 3. To Unload Gun

- a. Take plug out of coupling.  
b. Shake out used cartridge.

### SHOTSHELL DISPERSION CONTROL

When desired, shotshell can be modified to reduce shot dispersion.

#### MATERIAL REQUIRED:

Shotshell

Screwdriver or knife

Any of the following filler materials:

Crushed Rice

Rice Flour

Dry Bread Crumbs

Fine Dry Sawdust

#### PROCEDURE:

1. Carefully remove crimp from shotshell using a screwdriver or knife.



STAR CRIMP



ROLL CRIMP

NOTE: If cartridge is of roll-crimp type, remove top wad.



2. Pour shot from shell.



3. Replace one layer of shot in the cartridge. Pour in filler material to fill the spaces between the shot.

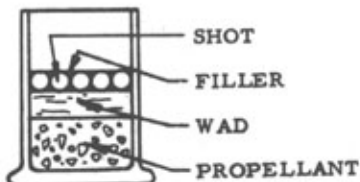

4. Repeat Step 3 until all shot has been replaced.
5. Replace top wad (if applicable) and re-fold crimp.



6. Roll shell on flat surface to smooth out crimp and restore roundness.



7. Seal end of case with wax.



#### HOW TO USE:

This round is loaded and fired in the same manner as standard shotshell. The shot spread will be about  $\frac{2}{3}$  that of a standard round.

CARBINE (7.62 mm Standard Rifle Ammunition)

A rifle can be made from water or gas pipe and fittings. Standard cartridges are used for ammunition.



MATERIAL REQUIRED:

Wood approximately 2 in. x 4 in.  
x 30 in.  
1/4 in. nominal size iron water or  
gas pipe 20 in. long threaded  
at one end.  
3/8 in. to 1/4 in. reducer  
3/8 in. x 1-1/2 in. threaded pipe  
3/8 in. pipe coupling  
Metal strap approximately 1/2 in.  
x 1/16 in. x 4 in.

Twine, heavy (100 yards approx.)  
3 wood screws and screwdriver  
Flat head nail about 1 in. long  
Hand drill  
Saw or knife  
File  
Pipe wrench  
Shellac or lacquer  
Elastic bands  
Solid 3/8 in. pipe plug

PROCEDURE:

1. Inspect pipe and fittings carefully.
  - a. Be sure that there are no cracks or flaws.
  - b. Check inside diameter of pipe. A 7.62 mm projectile should fit into 3/8 in. pipe.
2. Cut stock from wood using saw or knife.

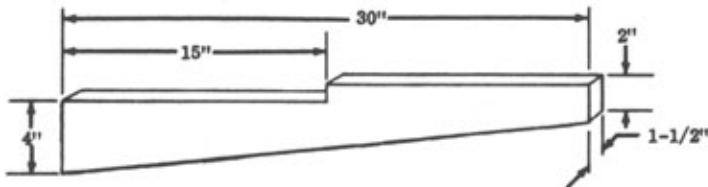

3. Cut a 1/4 in. deep "V" groove in top of the stock.

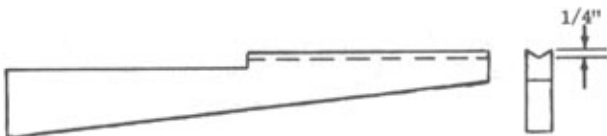

4. Fabricate rifle barrel from pipe.
- File or drill inside diameter of threaded end of 20 in. pipe for about 1/4 in. so neck of cartridge case will fit in.
  - Screw reducer onto threaded pipe using pipe wrench.
  - Screw short threaded pipe into reducer.

- d. Turn 3/8 pipe coupling onto threaded pipe using pipe wrench. All fittings should be as tight as possible. Do not split fittings.

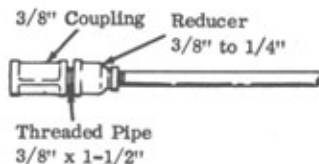

5. Coat pipe and "V" groove of stock with shellac or lacquer. While still wet, place pipe in "V" groove and wrap pipe and stock together using two layers of twine. Coat twine with shellac or lacquer after each layer.

6. Drill a hole through center of pipe plug large enough for nail to pass through.

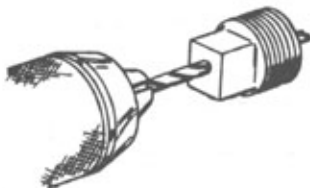

7. File threaded end of plug flat.



8. Push nail through plug and cut off rounded  $1/32$  in. (2 mm) past the plug.

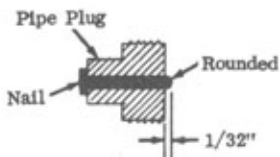

9. Screw plug into coupling.

10. Bend 4 in. metal strap into "L" shape and drill hole for wood screw. Notch metal strap on the long side  $1/2$  in. from bend.

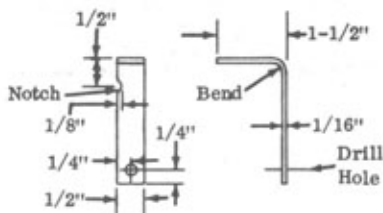

11. Position metal strap on stock so that top will hit the head of the nail. Attach to stock with wood screw.

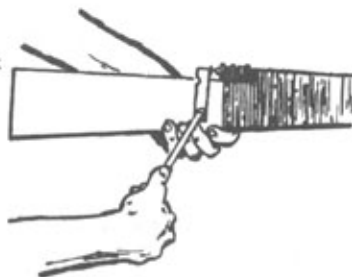

12. Place screw in each side of stock about 4 in. in front of metal strap. Pass elastic bands through notch in metal strap and attach to screw on each side of the stock.

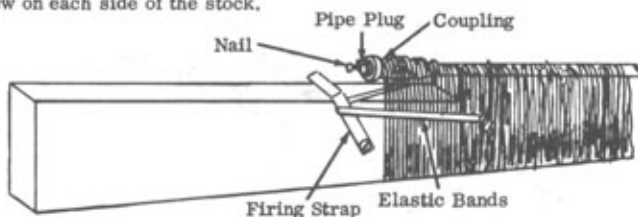

#### SAFETY CHECK - TEST FIRE RIFLE BEFORE HAND FIRING

1. Locate a barrier such as a stone wall or large tree which you can stand behind to test fire weapon.
2. Mount rifle solidly to a table or other rigid support at least ten feet in front of the barrier.



3. Attach a long cord to the firing strap on the rifle.
4. Holding the other end of the cord, go behind the barrier.
5. Pull the cord so that the firing strap is held back.
6. Release the cord to fire the rifle. (If the rifle does not fire, shorten the elastic bands or increase their number.)

**IMPORTANT:** Fire at least five rounds from behind a barrier and then reinspect the rifle before you attempt to shoulder fire it.

HOW TO OPERATE RIFLE:

1. To Load

- a. Remove plug from coupling.



- b. Put cartridge into pipe.



- c. Screw plug hand-tight into coupling.

2. To Fire



- a. Pull strap back and hold with thumb.
- b. Release strap.

3. To Unload Gun

- a. Take plug out of coupling.
- b. Drive out used case using stick or twig.

## REUSABLE PRIMER

A method of making a previously fired primer reusable.

MATERIAL REQUIRED:

Used cartridge case

2 long nails having approximately the same diameter as the inside of the primer pocket

"Strike-anywhere" matches - 2 or 3 are needed for each primer

Vise

Hammer

Knife or other sharp edged instrument

PROCEDURE:

1. File one nail to a needle point so that it is small enough to fit through hole in primer pocket.



2. Place cartridge case and nail between jaws of vise. Force out fired primer with nail as shown:

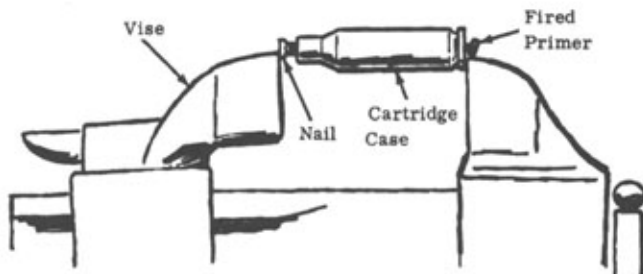

3. Remove anvil from primer cup.



4. File down point of second nail until tip is flat.
5. Remove indentations from face of primer cup with hammer and flattened nail.

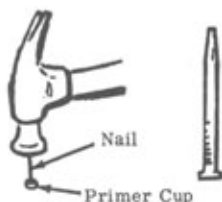

6. Cut off tips of the heads of "strike-anywhere" matches using knife. Carefully crush the match tips on dry surface with wooden match stick until the mixture is the consistency of sugar.

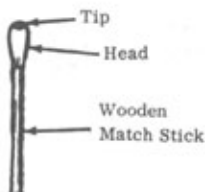

**CAUTION:** Do not crush more than 3 match tips at one time or the mixture may explode.

7. Pour mixture into primer cup. Compress mixture with wooden match stick until primer cup is fully packed.



8. Place anvil in primer pocket with legs down.

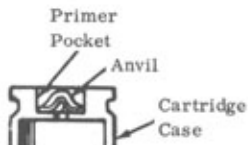

9. Place cup in pocket with mixture facing downward.

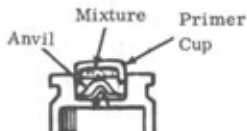

10. Place cartridge case and primer cup between vise jaws, and press slowly until primer is seated into bottom of pocket. The primer is now ready to use.

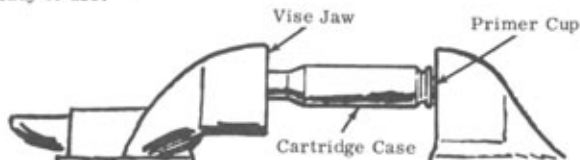

## PIPE PISTOL FOR .45 CALIBER AMMUNITION

A .45 caliber pistol can be made from 3/8 in. nominal diameter steel gas or water pipe and fittings. Lethal range is about 15 yards (13-1/2 meters).

MATERIAL REQUIRED:

Steel pipe, 3/8 in. (1 cm) nominal diameter and 6 in. (15 cm) long with threaded ends.  
2 threaded couplings to fit pipe  
Solid pipe plug to fit pipe coupling  
Hard wood, 8-1/2 in. x 6-1/2 in. x 1 in. (21 cm x 16-1/2 cm x 2-1/2 cm)  
Tape or string  
Flat head nail, approximately 1/16 in. (1-1/2 mm) in diameter  
2 wood screws, approximately 1/16 in. (1-1/2 mm) in diameter  
Metal strap, 5 in. x 1/4 in. x 1/8 in. (12-1/2 cm x 6 mm x 1 mm)  
Bolt, 4 in. (10 cm) long, with nut (optional).  
Elastic bands  
Drills, one 1/16 in. (1-1/2 mm) in diameter, and one having same diameter as bolt (optional).  
Rod, 1/4 in. (6mm) in diameter and 8 in. (20 cm) long  
Saw or knife

PROCEDURE:

1. Carefully inspect pipe and fittings.
  - a. Make sure that there are no cracks or other flaws in the pipe and fittings.
  - b. Check inside diameter of pipe using a .45 caliber cartridge as a gauge. The cartridge case should fit into the pipe snugly but without forcing.
  - c. Outside diameter of pipe MUST NOT BE less than 1-1/2 times the bullet diameter.
2. Follow procedure of Section III, No. 1, steps 4, 5, and 6.

FOR OFFICIAL USE ONLY

3. Cut stock from wood using saw or knife.

Inches	Centimeters
1-1/2	4 cm
8-1/2	26-1/2
6	20
1-1/2	4
5	12-1/2

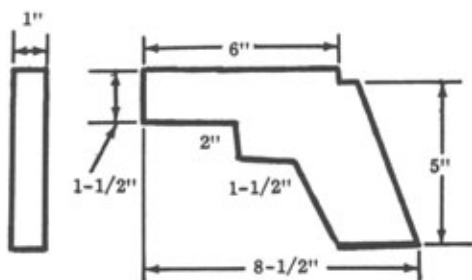

4. Cut a 3/8 in. (9-1/2 mm) deep groove in top of stock.



5. Screw couplings onto pipe. Screw plug into one coupling.



6. Securely attach pipe to stock using string or tape.



7. Follow procedures of Section III, No. 1, steps 10 and 11.

8. (Optional) Bend bolt for trigger. Drill hole in stock and place bolt in hole so strap will be anchored by bolt when pulled back. If bolt is not available, use strap as trigger by pulling back and releasing.

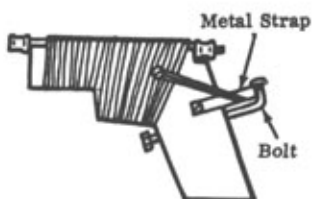

9. Follow SAFETY CHECK, Section III, No. 1

HOW TO USE:

1. To load:

- a. Remove plug from rear coupling.
- b. Wrap string or elastic band around extractor groove so case will seat into barrel securely.



- c. Place cartridge in pipe.



- d. Replace plug.

2. To Fire:

- a. Pull metal strap back and anchor in trigger.
- b. Pull trigger when ready to fire.



NOTE: If bolt is not used, pull strap back and release.

3. To remove cartridge case:

- a. Remove plug from rear coupling.
- b. Insert rod into front of pistol and push cartridge case out.



## MATCH GUN

An improvised weapon using safety match heads as the propellant and a metal object as the projectile. Lethal range is about 40 yards (36 meters).

MATERIAL REQUIRED:

Metal pipe 24 in. (61 cm) long and 3/8 in. (1 cm) in diameter (nominal size) or its equivalent, threaded on one end.

End cap to fit pipe

Safety matches - 3 books of 20 matches each.

Wood - 28 in. x 4 in. x 1 in. (70 cm x 10 cm x 2.5 cm)

Toy caps OR safety fuse OR "Strike-anywhere matches" (2)

Electrical tape or string

Metal strap, about 4 in. x 1/4 in. x 3/16 in. (10 cm x 6 mm x 4.5 mm)

2 rags, about 1 in x 12 in. and 1 in. x 3 in. (2-1/2 cm x 30 cm and 2-1/2 cm x 8 cm)

Wood screws

Elastic bands

Metal object (steel rod, bolt with head cut off, etc.), approximately 7/16 in. (11 mm) in diameter, and 7/16 in. (11 mm) long if iron or steel, 1-1/4 in. (31 mm) long if aluminum, 5/16 in. (8 mm) long if lead.

Metal disk 1 in. (2-1/2 cm) in diameter and 1/16 in. (1-1/2 mm) thick

Bolt, 3/32 in. (2-1/2 mm) or smaller in diameter and nut to fit

Saw or knife

PROCEDURE:

1. Carefully inspect pipe and fittings. Be sure that there are no cracks or other flaws.

2. Drill small hole in center of end cap. If safety fuse is used, be sure it will pass through this hole.

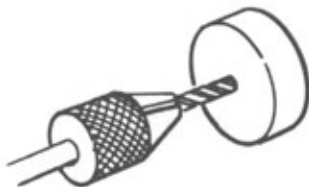

3. Cut stock from wood using saw or knife.

Metric	English
5 cm	2 in.
10 cm	4 in.
36 cm	14 in.
71 cm	28 in.

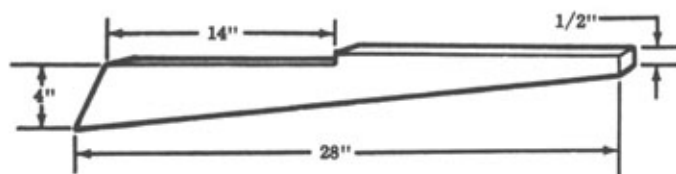

4. Cut 3/8 in. (9-1/2 mm) deep "V" groove in top of stock.



5. Screw end cap onto pipe until finger tight.  
6. Attach pipe to stock with string or tape.



7. Bend metal strap into "L" shape and drill holes for wood screw. Notch metal strap on long side 1/2 in. (1 cm) from bend.

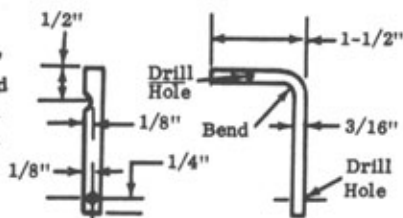

8. Position metal strap on stock so that the top will hit the center of hole drilled in end cap.



9. Attach metal disk to strap with nut and bolt. This will deflect blast from hole in end cap when gun is fired. Be sure that head of bolt is centered on hole in end cap.

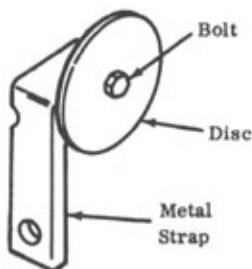

10. Attach strap to stock with wood screws.

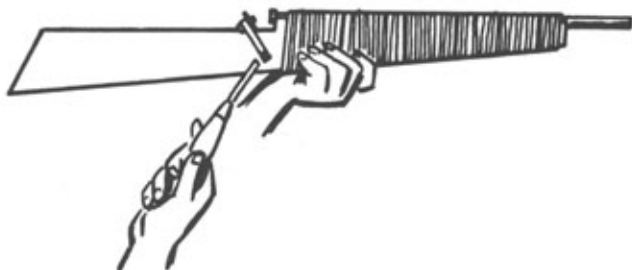

11. Place screw on each side of stock about 4 in. (10 cm) in front of metal strap. Pass elastic bands through notch in metal strap and attach to screw on each side of stock.



HOW TO USE:

A. When Toy Caps Are Available:

1. Cut off match heads from 3 books of matches with knife. Pour match heads into pipe.



2. Fold one end of 1 in. x 12 in. rag 3 times so that it becomes a one inch square of 3 thicknesses. Place rag into pipe to cover match heads, folded end first. Tamp firmly WITH CAUTION.

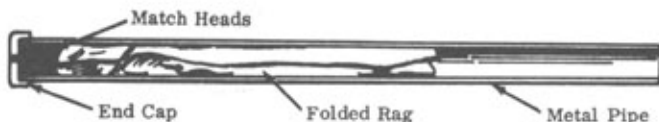

3. Place metal object into pipe. Place 1 in. x 3 in. rag into pipe to cover projectile. Tamp firmly WITH CAUTION.

4. Place 2 toy caps over small hole in end cap. Be sure metal strap will hit caps when it is released.

NOTE: It may be necessary to tape toy caps to end cap.

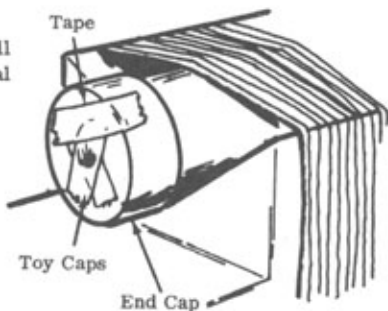

5. When ready to fire, pull metal strap back and release.

B. When "Strike-Anywhere" Matches Are Available:

1. Follow steps 1 through 3 in A.
2. Carefully cut off tips of heads of 2 "strike-anywhere" matches with knife.



3. Place one tip in hole in end cap. Push in with wooden end of match stick.

- Place second match tip on a piece of tape. Place tape so match tip is directly over hole in end cap.

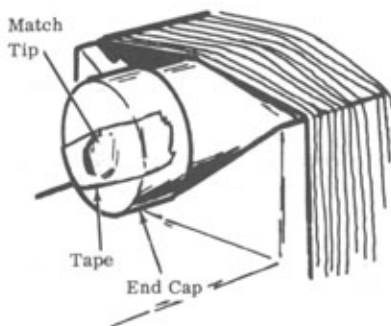

- When ready to fire, pull metal strap back and release.

C. When Safety Fuse Is Available: (Recommended for Booby Traps)

- Remove end cap from pipe. Knot one end of safety fuse. Thread safety fuse through hole in end cap so that knot is on inside of end cap.

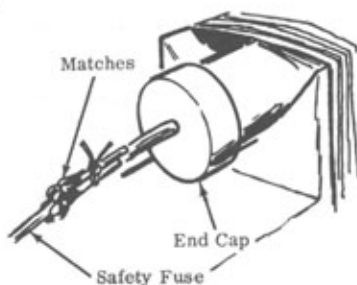

- Follow steps 1 through 3 in A.
- Tie several matches to safety fuse near outside of end cap.

NOTE: Bare end of safety fuse should be inside match head cluster.

- Wrap match covers around matches and tie. Striker should be in contact with match bands.

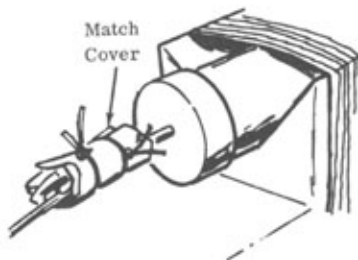

- Replace end cap on pipe.
- When ready to fire, pull match cover off with strong, firm, quick motion.

SAFETY CHECK - TEST FIRE GUN BEFORE HAND FIRING

1. Locate a barrier such as a stone wall or large tree which you can stand behind in case the weapon explodes when fired.
2. Mount gun solidly to a table or other rigid support at least ten feet in front of the barrier.
3. Attach a long cord to the firing strap on the gun.
4. Holding the other end of the cord, go behind the barrier.
5. Pull the cord so that the firing strap is held back.
6. Release the cord to fire the gun. (If gun does not fire, shorten the elastic bands or increase their number.)

**IMPORTANT:** Fire at least five rounds from behind the barrier and then re-inspect the gun before you attempt to shoulder fire it.

## RIFLE CARTRIDGE

NOTE: See Section III, No. 5 for reusable primer.

A method of making a previously fired rifle cartridge reusable.

MATERIAL REQUIRED:

Empty rifle cartridge, be sure that it still fits inside gun.

Threaded bolt that fits into neck of cartridge at least 1-1/4 in. (3 cm) long.

Safety or "strike-anywhere" matches (about 58 matches are needed for 7.62 mm cartridge)

Rag wad (about 3/4 in. (1-1/2 cm) square for 7.6 mm cartridge)

Knife

Saw

NOTE: Number of matches and size of rag wad depend on particular cartridge used.

PROCEDURE:

1. Remove coating on heads of matches by scraping match sticks with sharp edge.

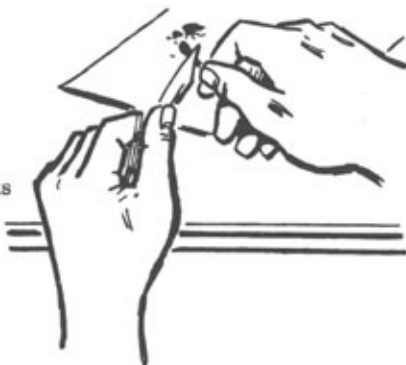

CAUTION: If wooden "strike-anywhere" matches are used, cut off tips first. Discard tips or use for Reusable Primer, Section III, No. 5.

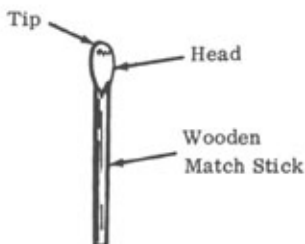

2. Fill previously primed cartridge case with match head coatings up to its neck. Pack evenly and tightly with match stick.

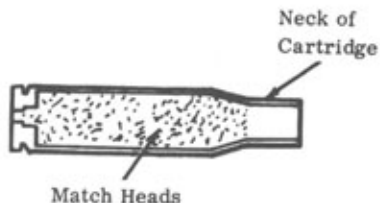

**CAUTION:** Remove head of match stick before packing. In all packing operations, stand off to the side and pack gently. Do not hammer.

3. Place rag wad in neck of case. Pack with match stick from which head was removed.

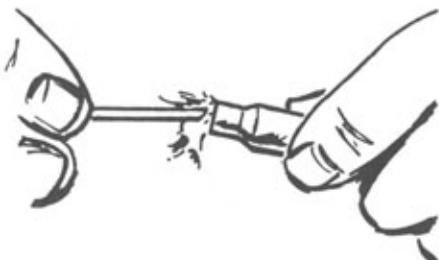

4. Saw off head end of bolt so remainder is approximately the length of the standard bullet.

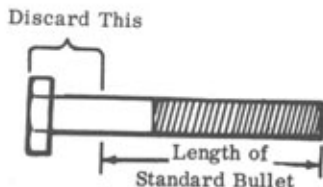

5. Place bolt in cartridge case so that it sticks out about the same length as the original bullet.

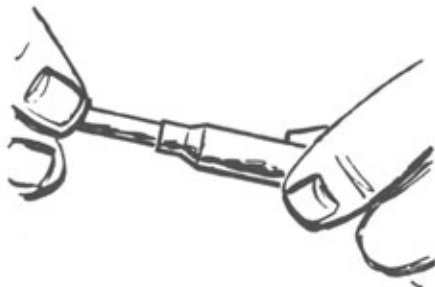

**NOTE:** If bolt does not fit snugly, force paper or match sticks between bolt and case, or wrap tape around bolt before inserting in case.

## PIPE PISTOL FOR .38 CALIBER AMMUNITION

A .38 caliber pistol can be made from 1/4 in. nominal diameter steel gas or water pipe and fittings. Lethal range is approximately 33 yards (30 meters).

MATERIAL REQUIRED:

Steel pipe, 1/4 in. (6 mm) nominal diameter and 6 in. (15 cm) long with threaded ends (nipple)  
 Solid pipe plug, 1/4 in. (6 mm) nominal diameter  
 2 steel pipe couplings, 1/4 in. (6 mm) nominal diameter  
 Metal strap, approximately 1/8 in. x 1/4 in. x 5 in. (3 mm x 6 mm x 125 mm or 12-1/2 cm)  
 Elastic bands  
 Flat head nail - 6D or 8D, approximately 1/16 in. diameter (1-1/2 mm)  
 2 wood screws, #8  
 Hard wood, 8 in. x 5 in. x 1 in. (20 cm x 12-1/2 cm x 2-1/2 cm)  
 Drill  
 Wood or metal rod, 1/4 in. (6 mm) diameter and 8 in. (20 cm) long  
 Saw or knife

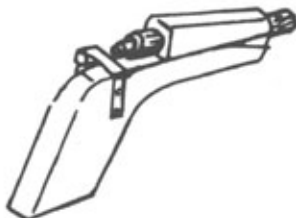
PROCEDURE:

1. Carefully inspect pipe and fittings.
  - a. Make sure that there are NO cracks or other flaws in the pipe or fittings
  - b. Check inside diameter of pipe using a .38 caliber cartridge as a gauge. The bullet should fit closely into the pipe without forcing, but the cartridge case SHOULD NOT fit into the pipe.
  - c. Outside diameter of pipe MUST NOT BE less than 1-1/2 times the bullet diameter.

2. Drill a  $35/64$  in. (14 mm) diameter hole  $3/4$  in. (2 cm) into one coupling to remove the thread. Drilled section should fit tightly over smooth section of pipe.

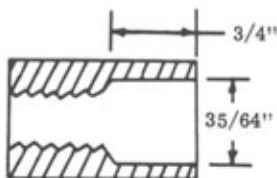

3. Drill a  $25/64$  in. (1 cm) diameter hole  $1-1/8$  in. (2.86 cm) into pipe. Use cartridge as a gauge; when a cartridge is inserted into the pipe, the shoulder of the case should butt against the end of the pipe. Thread coupling tightly onto pipe, drilled end first.

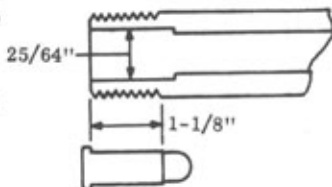

4. Follow procedures of Section III, No. 1, steps 4 through 11.
5. Follow SAFETY CHECK, Section III, No. 1.

#### HOW TO OPERATE PISTOL:

Follow procedures of HOW TO OPERATE PISTOL, Section III, No. 1, steps 1, 2, and 3.



PIPE PISTOL FOR .22 CALIBER AMMUNITION  
LONG OR SHORT CARTRIDGE

A .22 Caliber pistol can be made from 1/8 in. nominal diameter extra heavy, steel gas or water pipe and fittings. Lethal range is approximately 33 yards (30 meters).

MATERIAL REQUIRED:

Steel pipe, extra heavy, 1/8 in. (3 mm) nominal diameter and 6 in. (15 cm) long with threaded ends (nipple)

Solid pipe plug, 1/8 in. (3 mm) nominal diameter

2 steel pipe couplings, 1/8 in. (3 mm) nominal diameter

Metal strap, approximately 1/8 in. x 1/4 in. x 5 in. (3 mm x 6 mm x 125 mm or 12-1/2 cm)

Elastic bands

Flat head nail - 6D or 8D (approximately 1/16 in. (1-1/2 mm) diameter)

2 wood screws, #8

Hard wood, 8 in. x 5 in. x 1 in. (20 cm x 12-1/2 cm x 2-1/2 cm)

Drill

Wood or metal rod, 1/8 in. (3 mm) diameter and 8 in. (20 cm) long

Saw or knife

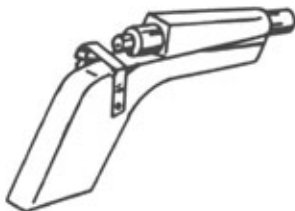
PROCEDURE:

1. Carefully inspect pipe and fittings.
  - a. Make sure that there are NO cracks or other flaws in the pipe or fittings.
  - b. Check inside diameter of pipe using a .22 caliber cartridge, long or short, as a gauge. The bullet should fit closely into the pipe without forcing, but the cartridge case SHOULD NOT fit into the pipe.
  - c. Outside diameter of pipe MUST NOT BE less than 1-1/2 times the bullet diameter.

FOR OFFICIAL USE ONLY

2. Drill a  $15/64$  in. (1/2 cm) diameter hole  $9/16$  in. (1-1/2 cm) deep in pipe for long cartridge. (If a short cartridge is used, drill hole  $3/8$  in. (1 cm) deep). When a cartridge is inserted into the pipe, the shoulder of the case should butt against the end of the pipe.

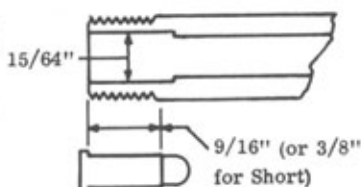

3. Screw the coupling onto the pipe. Cut coupling length to allow pipe plug to thread in pipe flush against the cartridge case.

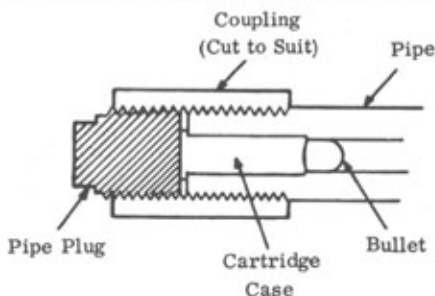

4. Drill a hole off center of the pipe plug just large enough for the nail to fit through.

NOTE: Drilled hole MUST BE OFF CENTER in plug.

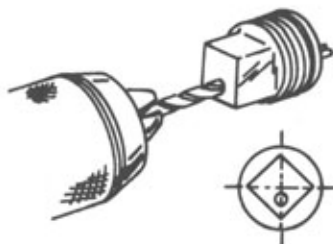

5. Push nail through pipe plug until head of nail is flush with square end. Cut nail off at other end  $1/16$  in. (1-1/2 mm) away from plug. Round off end with file.

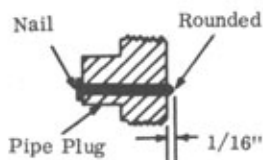

6. Follow procedures of Section III, No. 1, steps 6 through 11.

7. Follow SAFETY CHECK, Section III, No. 1.

HOW TO OPERATE:

Follow procedures of HOW TO OPERATE PISTOL, Section III, No. 1, steps 1, 2, and 3.

## LOW SIGNATURE SYSTEM

Low signature systems (silencers) for improvised small arms weapons (Section III) can be made from steel gas or water pipe and fittings.

MATERIAL REQUIRED:

Grenade container

Steel pipe nipple, 6 in. (15 cm) long -

See Table I for diameter

2 steel pipe couplings - See Table II  
for dimensions

Cotton cloth - See Table II for  
dimensions

Drill

Absorbent cotton

PROCEDURE:

1. Drill hole in grenade container at both ends to fit outside diameter of pipe nipple. (See Table I.)
2. Drill four (4) rows of holes in pipe nipple. Use Table I for diameter and location of holes.

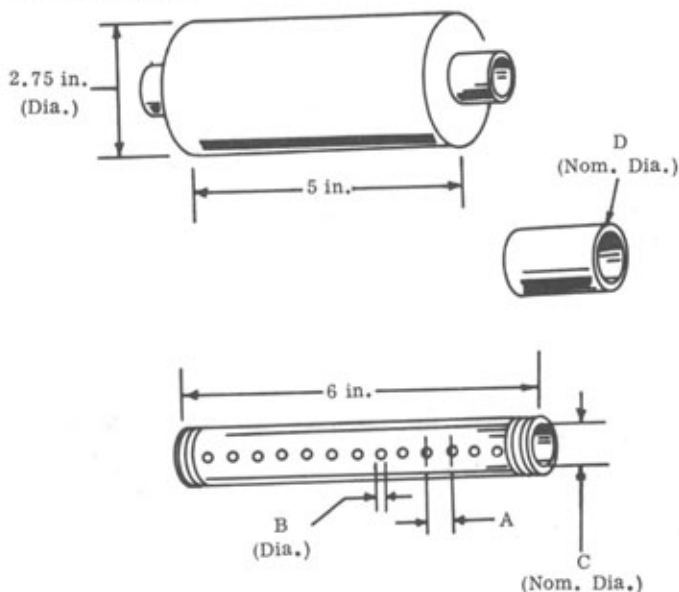

FOR OFFICIAL USE ONLY

Table I. Low Signature System Dimensions

	A	B	C	(Coupling) D	Holes per Row	(4-Rows) Total
.45 Cal.	3/8	1/4	3/8	3/8	12	48
.38 Cal.	3/8	1/4	1/4	1/4	12	48
9 mm	3/8	1/4	1/4	1/4	12	48
7.62 mm	3/8	1/4	1/4	1/4	12	48
.22 Cal.	1/4	5/32	1/8*	1/8	14	50

\*Extra Heavy Pipe

All dimensions in inches

3. Thread one of the pipe couplings on the drilled pipe nipple.

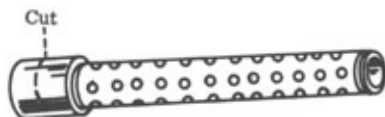

4. Cut coupling length to allow barrel of weapon to thread fully into low signature system. Barrel should butt against end of the drilled pipe nipple.

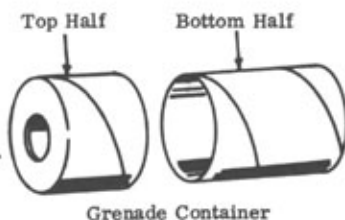

5. Separate the top half of the grenade container from the bottom half.

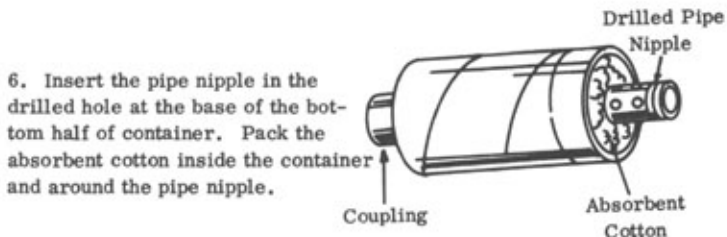

6. Insert the pipe nipple in the drilled hole at the base of the bottom half of container. Pack the absorbent cotton inside the container and around the pipe nipple.

FOR OFFICIAL USE ONLY

7. Pack the absorbent cotton in top half of grenade container leaving hole in center. Assemble container to the bottom half.

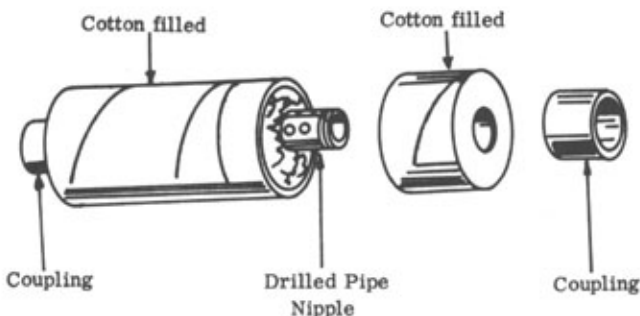

8. Thread the other coupling onto the pipe nipple.

**NOTE:** A longer container and pipe nipple, with same "A" and "B" dimensions as those given, will further reduce the signature of the system.

HOW TO USE:

1. Thread the low signature system on the selected weapon securely.
2. Place the proper cotton wad size into the muzzle end of the system.

Table II. Cotton Wadding - Sizes

Weapon	Cotton Wad Size
.45 Cal.	1-1/2 x 6 inches
.38 Cal.	1 x 4 inches
9 mm	1 x 4 inches
7.62 mm	1 x 4 inches
.22 Cal.	Not needed

3. Load Weapon
4. Weapon is now ready for use.



**DESERT  
PUBLICATIONS**

CORNVILLE, ARIZONA 86325

This book has been reproduced from Volume 1 of the complete and original Special Forces loose leaf Black Books and should not be confused with TM 31-210, which contains only part of the material included herein.