



THE ADVANCED ANARCHIST ARSENAL

RECIPES FOR
IMPROVISED
INCENDIARIES
AND EXPLOSIVES

DAVID HARBER

To the memory of George Elser, German patriot, skilled artisan, and master bomber, who on November 7, 1939, came within eight minutes of ridding the world of Adolph Hitler.

THE ADVANCED ANARCHIST ARSENAL

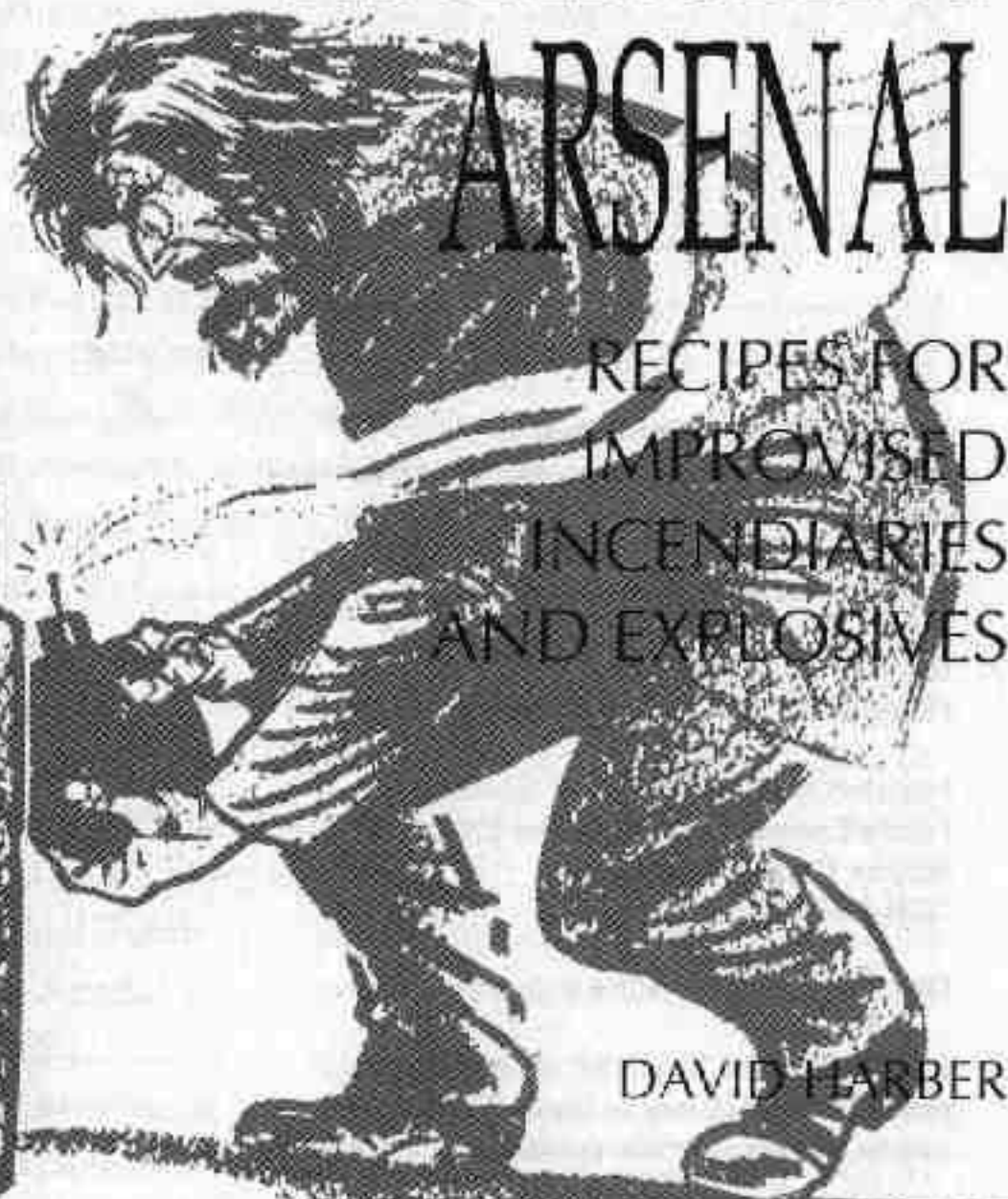

RECIPES FOR
IMPROVISED
INCENDIARIES
AND EXPLOSIVES

DAVID HARBER

PALADIN PRESS
BOULDER, COLORADO

CONTENTS

Introduction	1
Kinepak	5
Nitromethane Explosives	6
Gelled Nitromethane Explosive	9
Sullivanite	10
ANFO+	11
80/20 Amatol Production	12
Fan Fuze	13
IRA Truck Mortar	17
Nineteenth Century Anarchist's Bomb	20
Military Mining	22
Structural Demolitions	31
ERDL Square Charge	36
Baby Bottle Bomb	38
Napalm B-N	40
Jar Molly	41
Self-Igniting Firebombs	44
Rhodesian Knock-Knock	55
Ammonpolver (AP)	57
Dr. Scheele's Fiery Cigar	60
Mothball Bomb	62
80/20 Amatol	69
Nipolit	71
Antidisturbance Mine	77
Fume Absorber	81
Recycling Explosives	83

Also by David Harber:

The Anarchist Arsenal:

Improvised Incendiary and Explosives Techniques

Improvised Land Mines:

Their Employment and Destructive Capabilities

The Advanced Anarchist Arsenal:

Recipes for Improvised Incendiaries and Explosives

by David Harber

Copyright © 1991 by David Harber

ISBN 0-87364-634-7

Printed in the United States of America

Published by Paladin Press, a division of
Paladin Enterprises, Inc., P.O. Box 1307,
Boulder, Colorado 80306, USA.
(303) 443-7250

Direct inquiries and/or orders to the above address.

All rights reserved. Except for use in a review, no
portion of this book may be reproduced in any form
without the express written permission of the publisher.

Neither the author nor the publisher assumes
any responsibility for the use or misuse of
information contained in this book.

WARNING

The procedures in this manual and the resulting end product are extremely dangerous. Whenever dealing with high explosives, special precautions should be followed in accordance with industry standards for experimentation and production of high explosives. Failure to strictly follow such industry standards may result in harm to life or limb.

Therefore, the author and publisher disclaim any liability from any damages or injuries of any type that a reader or user of information contained within this manual may encounter from the use of said information. Use this manual and any end product or by-product at your own risk. This manual is for information purposes only.

INTRODUCTION

It's been a busy year. Lebanon has surrendered its unwanted title of bombing capital of the world to Colombia. The narco-terrorists have launched a savage campaign of intimidation against the Colombian people. Assassinations and terror bombings occur daily. Most of the devices used have been low-tech to the extreme—your basic fuze cord, blasting cap, and dynamite rig. This is primarily due to the low caliber of their deliverymen, most of whom have been "take it here, light the fuze, and leave" sort of guys. With the fuzes generally being only a few feet long, most of these bombs have gone off as planned. Simple and effective.

The West German Red Army Faction (RAF) seems to be back in business, bigger and badder than ever. They've come up with a few innovations to try to improve their abysmal track record in the field. (The RAF has a history of bad aim.) In November 1989 they used an ingenious photoelectric bomb to kill banker Alfred Herrhausen. The bomb, hidden in the saddlebags of a bicycle parked on the street, used a remote-wire activation system. When the first car in Herrhausen's three-car convoy passed the bomb, the command wire was used to turn on the photoelectric beam. When the second car, which contained the target, broke the beam, the bomb detonated. A bit complicated, but it worked.

The ever-popular Irish Republican Army (IRA) is at it again, with mixed success. Both the regular and the tilt-fuzed car bombs have been used. No real surprises from this camp. They prefer to use what has worked for them in the past, but to give "credit" where it is due, they are still about the best at their dubious profession.

On the opposite side, the war in the shadows continues. Despite loud assurances that "something is being done," I'm not sure we've learned anything from the

past. Dr. Jim Swire, father of one of the victims in the Pan Am 103 bombing, smuggled a fake bomb on board a flight to New York from Heathrow airport. He had the bomb constructed exactly like the one believed to have been used in his daughter's murder. It contained a dummy detonator, extra batteries, an extra printed circuit board, and a pressure transducer. The Semtex used in the original was replaced with marzipan icing. Experts who examined the bomb said if the detonator and marzipan were replaced with the real items, it would definitely have exploded. Even though the flight was singled out for "special security," the bomb passed through with no problems. Window dressing and grave assurances mean nothing.

No security system is perfect, and even if it were, it is only a matter of time before the technology necessary to circumvent it arrives. This is the way the game has always been played, but in this case it wasn't even necessary to develop new technology. The system became lax and allowed a known and widely publicized threat to slip through. As a philosopher once said, "Fool me once, shame on you; fool me twice, shame on me." This is the sort of thing terrorists count on.

The period immediately following the latest outrage is characterized by tight and rigorous security. The terrorists lie low. A few months, maybe a year, goes by with no incidents. Security eases and becomes only a dull routine. This is when they strike, and the whole process begins again. It becomes an endless cycle, with us on the receiving end.

If we wish to effectively combat terrorism, we may do well to adopt the strategies used so successfully by the Israelis (unending vigilance) and the Soviets (utter ruthlessness). The Israelis haven't had an airliner hijacked since 1968, and the last air bombing they had in 1972 was thwarted by the armored baggage compartments that are standard equipment on all El Al aircraft.

Though many have tried in the intervening years, none have been successful. The technology to combat these attacks exists; it needs only to be implemented. When four Russians were kidnapped in Beirut several years ago, the Soviets responded with a little kidnapping of their own. They seized several close relatives of the kidnap group, chopped one of them to pieces, and sent him back with a request that their people be released. The hostages were returned the next day. Messy? Yes. Effective? Very.

Terrorists rely on us to play by our normal set of rules when dealing with them and are surprised when the game is played by *their* rules, with them on the receiving end. I am reminded of an incident that occurred during the Iranian hostage crisis. During one of Washington's endless cocktail parties, an American diplomat asked his Soviet counterpart why no one ever attacked Russian embassies. His reply was short and to the point: "It is very simple. We do not allow it."

I've been asked several times about my motivation for writing this book's precursor, *The Anarchist Arsenal*. Am I not providing terrorists with the means to take more innocent lives? No. That's a stupid question. My reasons are two-fold.

First, this information provides examples of how terrorists have operated in the past and how they may behave in the future. Believe me, I'm not telling the terrorists of the world anything they don't already know. The IRA has enough misguided PhDs to build them pretty much anything they want. When the FBI arrested Richard C. Johnson, a Northrop engineer and de facto chief of research and development for the IRA's "Bomb Command South," they found a few things that surprised them. Johnson had developed or was in the process of designing, among other things, unjammable radio detonation devices, detonators based on a police model radar gun, and a hand-held surface-to-air missile

incorporating a radar proximity fuze. They don't need books such as mine.

The second reason is to provide details on how these devices are built so that the knowledge will be available should the need arise in the future. With the current assault on the Second Amendment by certain politicians and media groups, easily made explosives and incendiaries may be the only weapons available. Until they finally learn the basic truth that it is not the object that is the deadly weapon, but the heart of the man wielding it, freedoms will continue to erode.

This country is too good to lose in such a manner. Do your part and vote.

KINEPAK

Kinepak is the family name of various types of two-component high explosives manufactured by the Atlas Powder Company. Kinepak has a detonation velocity of 20,100 feet per second (fps), which is less than TNT, but the U.S. Bureau of Mines gave it a Relative Effectiveness Factor (REF) of 1.33—a third again as powerful as TNT. By way of comparison, C-4 has an REF of 1.34.

Kinepak is sold in two basic forms: Kinepouch and Kinestik. Kinepouch is a plastic-lined foil pouch or tube containing powdered ammonium nitrate (AN). It comes in 1/2-, 1-, 2-, and 4-pound sizes. Each pouch comes with a premeasured tube of nitromethane (NM) sensitizer. To use, simply open the pouch, pour in the NM, and wait five minutes. Prime with a No. 6 blasting cap.

Kinestik consists of a hard plastic tube with screwtop and recessed cap well. It comes in 1/3- and 1-pound sizes comparable in size and shape to the common dynamite stick, and it also includes premeasured tubes of NM. It is activated and primed just like Kinepouch.

NITROMETHANE EXPLOSIVES

It has become fairly well known over the last few years that a simple and powerful high explosive can be made by pouring liquid nitromethane into powdered ammonium nitrate or by adding various liquid sensitizers to nitromethane. Unfortunately, as this knowledge spread, the ready supply of nitromethane dried up. Chemical companies that once stocked technical-grade NM at less than ten dollars a pint now sell only reagent grade at thirty-five dollars or more a pint. These formerly cheap two-component explosives are now prohibitively expensive, except as manufactured items (e.g., Kinestik by the Atlas Powder Company).

Even the use of nitromethane in conventional industry is now controlled. The only place it can be found in any reasonable concentration is in model racing fuels. A large, well-stocked radio control racing shop will have fuels containing up to 60 percent NM, the remainder being methanol and a little cylinder lubricant. The 60-percent NM may be removed from the fuel by fractional distillation under vacuum, a relatively simple process once you know how to do it.

Due to this scarcity of NM, methods have been found to reduce the amount needed while not seriously degrading the performance of the explosive. One way is to mix another nonreacting hydrocarbon with the NM so that less of the scarce material is needed. Trichloroethane (a common cleaning fluid) has proven very useful in stretching the supply of NM. It gave excellent results in testing, using commercial Kinestik and 70-percent dynamite as standards. It was found that by varying the amount of liquid sensitizer in the mixture, different levels of powder could be obtained (see chart).

If you don't want to bother with separating the NM from the fuel, the following formula can be used: fifty parts ammonium nitrate and seven parts 55-percent fuel, by weight. This can be detonated with a No. 6 blasting cap. The following chart is a collection of mixtures that either reduce the amount of NM needed or increase its power.

AN/NM EXPLOSIVE STEEL PLATE DENT TEST

TEST	#1	#2	#3	#4	#5	#6	#7	#8	#9	#10
Granular AN	40	40	40	40		40	40	40	40	
Nitromethane	4	6	7	9		2.8	4	5	5.5	
Trichloroethane	3	3	3	3		2.8	4	5	5.5	
Kinestik Solid					40					
Kinestik Liquid					12					
70% Dynamite										50
Depth of Dent in Steel Plate (in .001 inches)	50	73	93	103	103	44	64	68	70	52

Note: All components are by weight.

All mixtures were contained in a 1 1/8-inch diameter plastic tube and initiated with a No. 6 blasting cap. As you can see, the performance was not proportional to the amount of activating liquid used. For example, test #8 used 25 percent more liquid and achieved only a slight increase in power over test #7. All of these explosives are quite volatile and will become inactive in the open air within about fifteen minutes. Therefore, they should always be used in sealed containers.

Incidentally, Kinestik solid is finely powdered AN, while Kinestik liquid is believed to be 95 percent nitromethane and 5 percent nitropropane.

The performance of these types of explosives can be

improved by the addition of 1 to 5 percent water to the powdered AN. When the water is removed, it leaves a porous structure that is resistant to settling and compaction. This absorbs the NM more evenly and gives a consistent sectional density for peak performance.

This is accomplished by spreading the powdered AN on a nonporous surface and evenly spraying the required amount of water over it. Allow about five minutes for the water to soak in and pour it into a glass jar or other charge container. Place the container in an oven on low heat until the water has evaporated completely. Remove from the oven and seal. When you are ready to use the charge, just remove the lid and pour in the NM carefully. Allow five minutes or so for it to mix evenly. Kinestik uses a special pink dye in the liquid to show when it is properly mixed, which might be worth considering.

GELLED NITROMETHANE EXPLOSIVE

A good, stable high explosive may be made by mixing twenty parts gelled nitromethane to eighty parts powdered ammonium nitrate. The nitromethane is gelled by the addition of 1 to 10 percent nitrocellulose, in the form of modified, single-base smokeless gunpowder. The smokeless powder is softened in a little acetone and spread out on a smooth surface to dry. It is then broken up into a granular powder. It will dissolve more readily in the NM in this form.

This explosive is an improvement over conventional NM/AN mixtures in that it is substantially nonvolatile, uses less nitromethane, and has a greatly extended shelf life. For example, the commercial NM/AN explosive called Kinestik uses 64 grams NM and 160 grams AN to make a half-pound "stick." This mixture uses 179 grams AN and 45 grams NM to achieve the same level of power. It is roughly equal to TNT.

PROCEDURE:

1) Add the smokeless powder to the nitromethane and stir until it is dissolved. Gelation should begin to occur within a few minutes.

2) Add twenty parts, by weight, of this mixture to eighty parts ammonium nitrate. Blend until a homogeneous mixture is obtained.

3) Press this into a charge container, block mold, or the like. (I am particularly fond of glass jars.) This explosive can be detonated by a No. 6 blasting cap, but a No. 8 should be used if possible.

SULLIVANITE

This explosive was developed recently at the Edgewood Arsenal for the U.S. Army. As far as I know it has no name yet, so I have dubbed it "Sullivanite" after its inventor, John D. Sullivan, Jr. It consists of twenty-nine to thirty-four parts TNT dissolved in sixty to sixty-four parts nitromethane and six to six and one-half parts pyridine, by weight. The combination of NM and pyridine forms a powerful liquid explosive. It was one of the early two-component high explosives developed in the late 1940s. The addition of TNT increases its power by about 35 percent. In testing, three J-2 blasting caps were used to initiate the explosive, but there is no reason one wouldn't do it. The following instructions are for the preparation of one liter of the explosive liquid (1,282 grams).

PREPARATION:

1) Pour 435.9 grams of TNT into a 1-liter resealable glass or plastic container. The TNT may be in flake or powder form, but the more finely divided it is, the faster it will dissolve.

2) Pour 769.2 grams (680.7 milliliters) of nitromethane into the container and seal. Gently agitate the mixture to dissolve the TNT, then let it sit for one hour. (NOTE: If any TNT remains in the bottom of the container after one hour, break it up with a stick and stir until it is dissolved.)

3) Add 76.9 grams of pyridine to the solution and stir briefly. The mixture will turn a deep purple. (NOTE: It is a good idea to wait to add the pyridine to the solution until the point of use. The NM/TNT mixture is not detonable until this is done.)

ANFO+

ANFO+ is basically a cross between regular ANFO and amatol. It has a considerable advantage over conventional amatol in that it does not require melting the explosives before mixing. It also uses RDX as a replacement for the TNT used in amatol. RDX is 50 percent more powerful and is quite a bit easier to manufacture than TNT, which is a pain in the ass. This gives it a power approximately equal to that of straight TNT, but at a much lower cost. While not suitable for all needs, it is excellent for many bulk explosive projects, such as pure blast bombs.

TO MANUFACTURE:

- 1) Place the AN prills in a small concrete tumbler.
- 2) Add the required amount of fuel oil (6 percent by weight) and tumble for fifteen minutes or until homogenized.
- 3) Add the required amount of RDX (20 percent by weight) and tumble for another fifteen minutes.
- 4) Pour into charge containers and press to remove air bubbles.
- 5) Prime with a blasting cap.

80/20 AMATOL PRODUCTION

Amatol production is an excellent way of stretching an explosives supply, getting more bang for your buck, as it were. It is not as safe to make as some other high explosives since it uses molten TNT (very shock-sensitive), but it should present no trouble if reasonable care is exercised.

PROCEDURE:

1) Heat a kettle containing eight parts finely powdered ammonium nitrate to 90°C on a water bath. A flour grinder at low speed is adequate for powdering the AN. Seal the receiving container immediately after grinding the AN, as it will absorb moisture from the air.

2) Heat a second kettle containing two parts TNT on a water bath until the TNT is melted.

3) Pour the TNT into the first kettle containing the AN and stir until completely mixed. The amatol will resemble wet brown sugar and have a consistent color and texture when properly mixed.

4) Pour the amatol into block molds or charge containers while it is still hot. Use a cover to gently press the surface for maximum density and to remove air bubbles. It is important that the blocks are protected from dampness or other moisture. Sealing them in plastic bags is a good method, as is wrapping them in wax paper and dipping them in wax. Be sure to form a cap well before they are sealed.

FAN FUZE

This device is just the thing for dealing with those pesky helicopters that sometimes drop assault teams on the roof of a hideout. Coupled with a strategically placed claymore mine, it will eliminate the bother quickly and efficiently, while providing you with a warning.

When a helicopter descends it creates a strong vertical air current known as prop wash. This causes the fan blade in the fuze to spin, which in turn creates a current flow from the generator. This current is directed to the gate prong of a silicon-controlled rectifier (SCR), which will open the circuit from the battery when sufficient power is present.

As the illustration shows, the fan is housed in a section of stove pipe so that it will not be affected by normal horizontal air currents (wind). A piece of coarse screen is mounted on top to break up any large raindrops that might cause the blades to spin, and to prevent them from being clogged by any windblown litter. As many different fan/generator combinations are possible, you will have to test to be sure that the fan blade on the assembly can move freely. It must be able to spin under the appropriate conditions.

The claymore is mounted in a shallow wooden box filled with sand and raised above the roof level on wooden legs. This is destroyed when the mine is detonated and serves to absorb some of the backblast and reduce damage to the roof. The claymore is aimed across the center of the roof and at an upward angle of about 45 degrees. When the helicopter attempts to deliver its load, the prop wash will cause the fan blade in the fuze to spin, detonating the mine. Problem solved.

NOTE: For more complete vertical coverage of the area above the roof, you may want to improvise a hemispherical claymore. This is made from one of the old

"baby moon" hubcaps popular in the 1960s. Cover the front of the hubcap with epoxy and quarter-inch ball bearings, pack the rear with explosive, and mount it in the center of the roof.

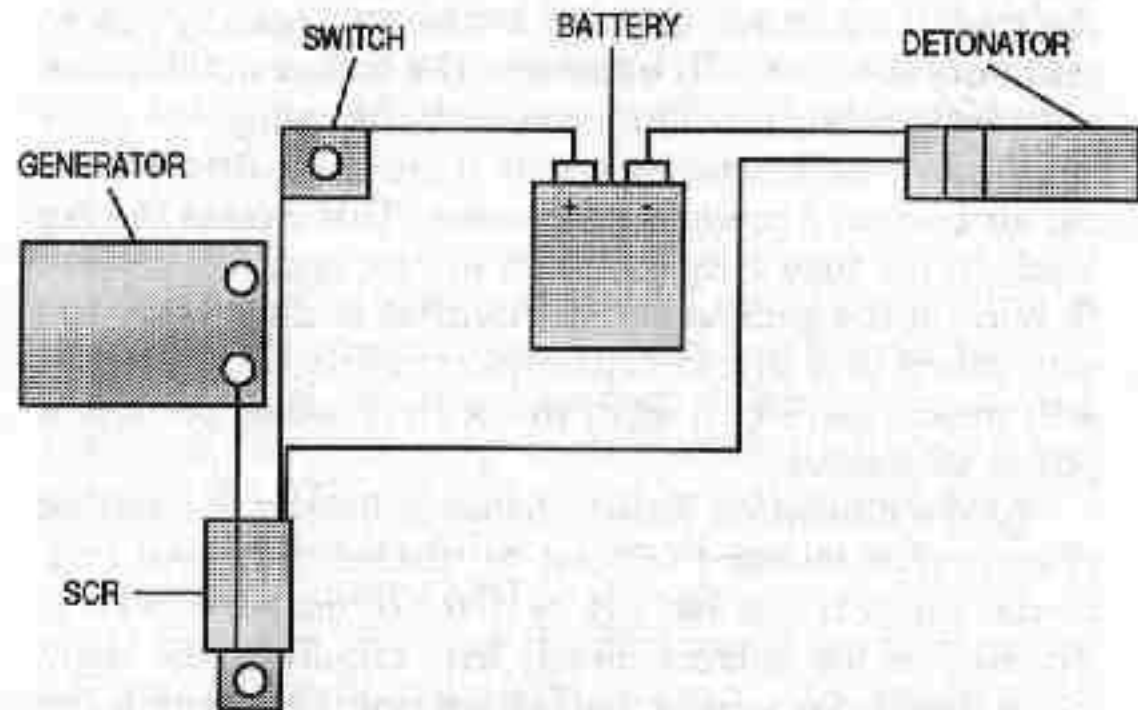

Fan fuze circuit drawing.

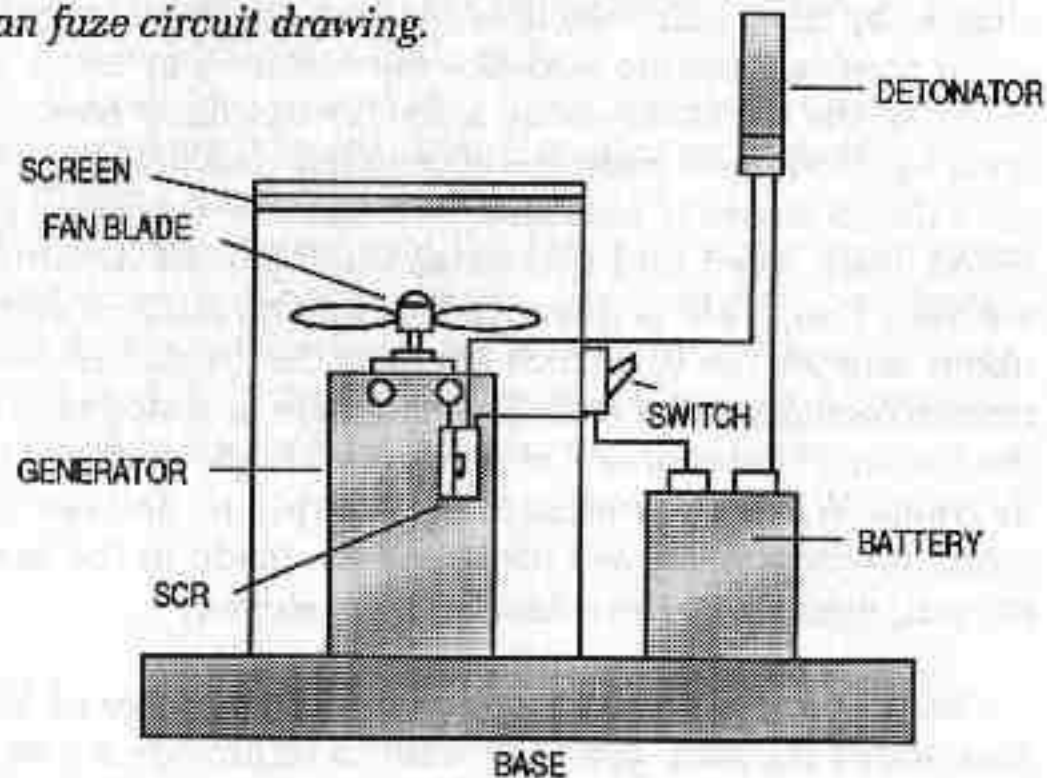

Fan fuze schematic.

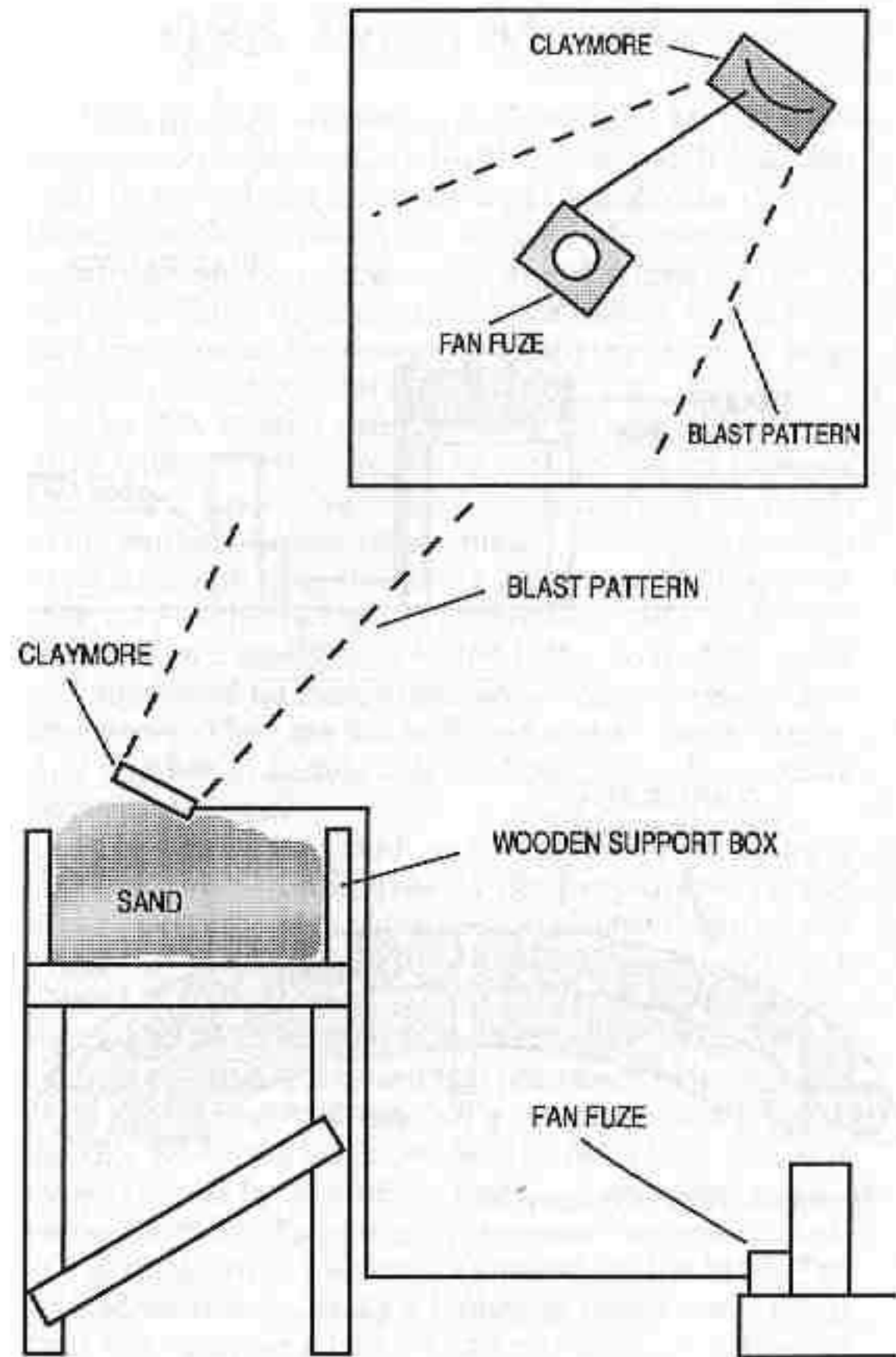

Fan fuze layout.

IRA TRUCK MORTAR

This unusual weapon was developed by the ever-ingenuous Provos for use in Northern Ireland. It has been used in several attacks on barracks and police stations throughout the North. While a dandy area weapon, it is usually grossly inaccurate against point targets such as small buildings. Against targets such as tank farms, military bases, or ammo dumps, it is superb, raining large canisters of high explosive all over the area.

The IRA usually uses modified oxygen cylinders—filled with explosive and fitted with an impact fuze—as projectiles. These may or may not have fins. The barrels of the mortars themselves are made of steel tube, averaging 8 inches in diameter and 4 feet in length. (The size may vary with the type of projectile used.) These are mounted on a sturdy base bolted to the floor of the truck and supported on their upper ends with an angled iron framework. They are normally set at a 45-degree angle. Any number of barrels may be fitted, though most use from four to eight.

A low explosive such as black powder or sodium chlorate/sugar mix is used as the propellant. This is packed in plastic bags containing an electrical igniter and placed in the bottom of the tube. Some wadding is pressed in over the bags, and the projectile is loaded, taking care to avoid damage to the firing wire. Tests have to be made to determine how much propellant to use.

A timing unit and activating switch are mounted in the cab. When the truck reaches the launching area it is roughly aimed by moving the truck around and then activating the timer. The driver then leaves the area on foot, as the truck will be severely damaged by the blast. The favored vehicle is usually a flatbed or dump truck. On at least one occasion a Hitachi van was used. A portion of the roof over the mortar tubes was cut out and replaced

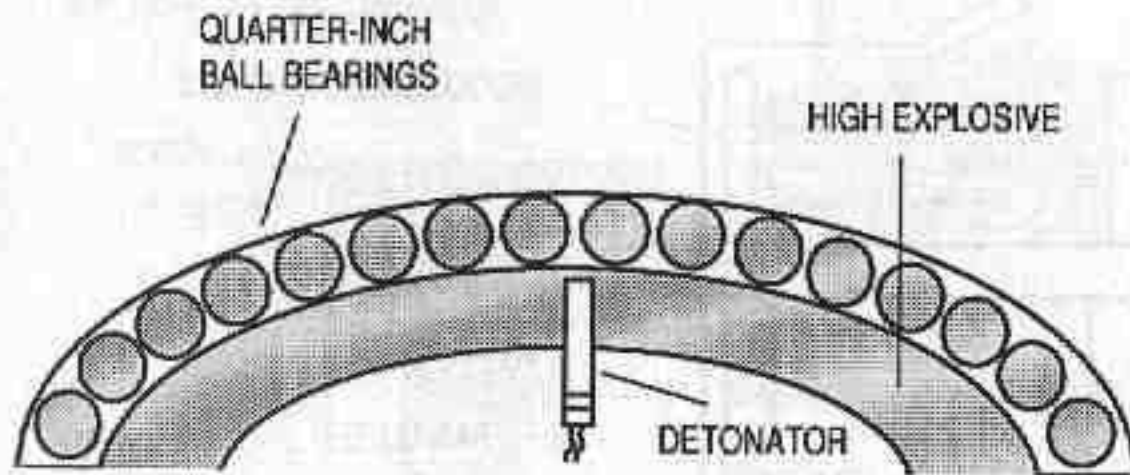
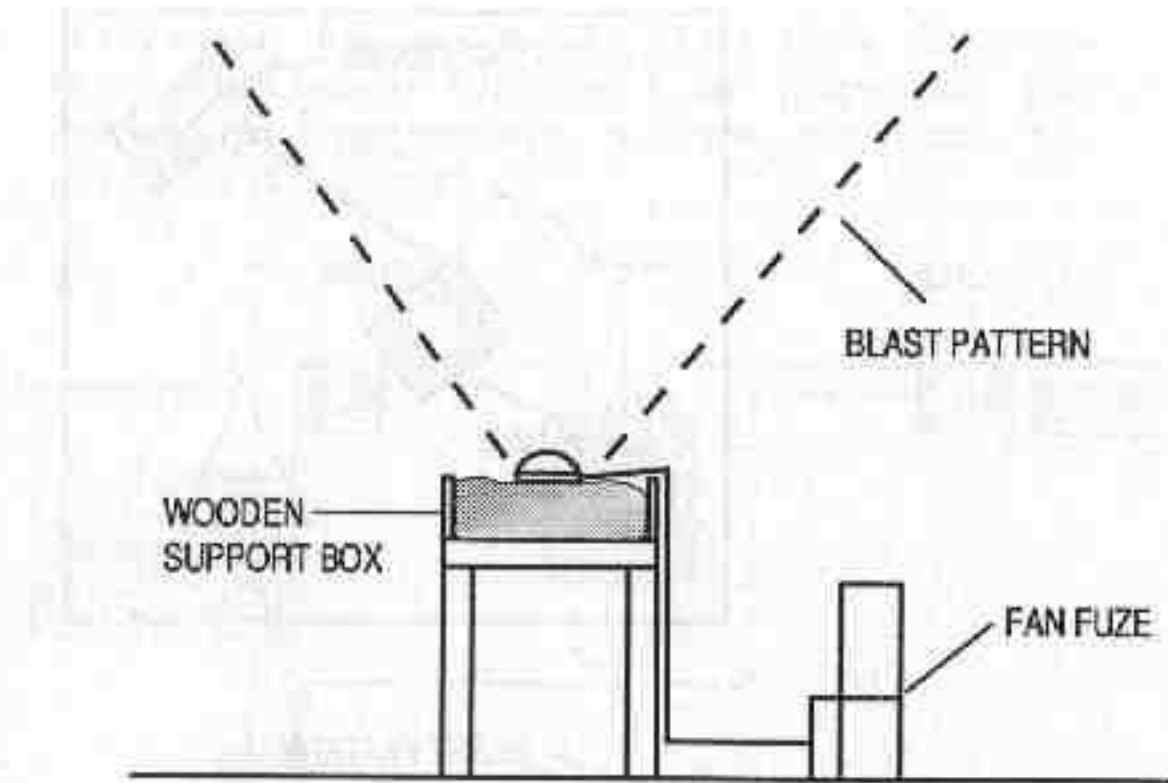

Hemispherical claymore.

with a cardboard replica painted to resemble the real thing. This was blown out when the mortars fired.

NOTE: As this book was going to print, the IRA Truck Mortar struck again. On 7 February 1991, a three-barreled version of the device was used in an assassination attempt against British Prime Minister John Major while he met with his war cabinet at 10 Downing Street. The van used in the attack was parked about 150 yards away next to the Ministry of Defense building. It also contained a self-destruct device, which set it aflame when the mortars fired. Although no one was killed in the attempt, three people incurred minor injuries. This was the first case of this weapon being used outside Northern Ireland.

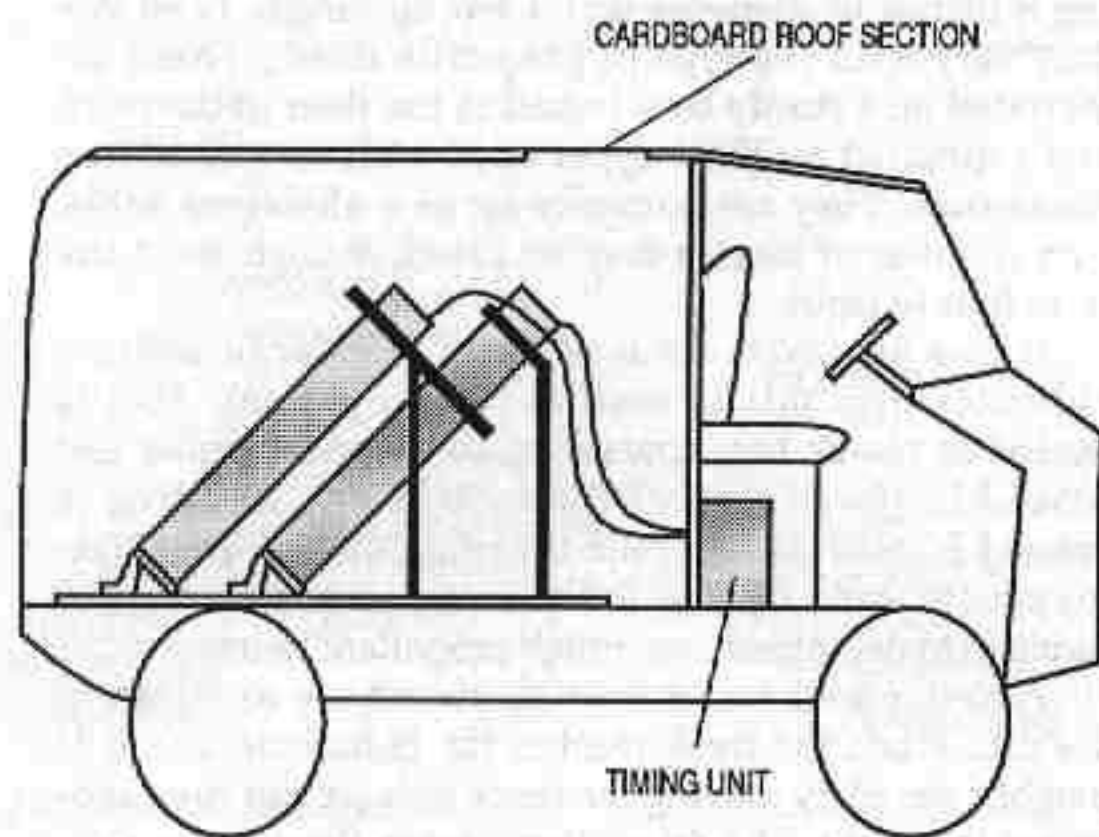

IRA truck mortar mounting.

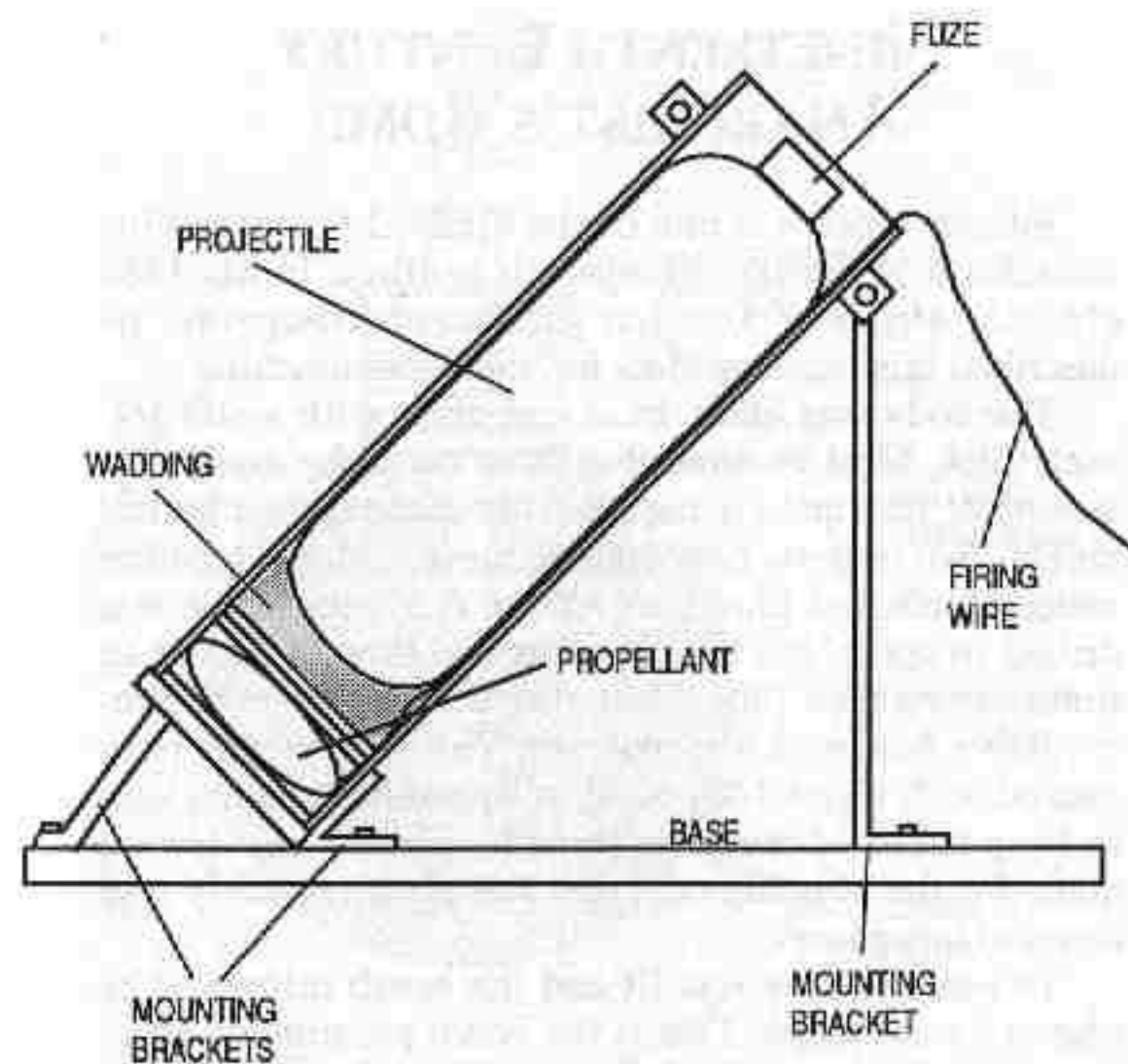

Sectioned view of IRA truck mortar.

NINETEENTH CENTURY ANARCHIST'S BOMB

Johann Most was one of the original fire-breathing anarchists of the late nineteenth century. In his 1884 classic, *Military Science for Revolutionaries*, he described this bomb as ideal for home manufacture.

The body was made from cast zinc, with walls 1/2-inch thick. Most claimed that these could be easily cast in a small apartment using specially made hemispherical molds. Two of these hemispheres were soldered together using a torch and plumber's solder. A 3/4-inch hole was drilled in one of the hemispheres and threaded to fit an iron or brass pipe plug. This plug was drilled to accommodate a fuze and blasting cap. The sphere was then packed with about 1/2 pound of dynamite, making sure to keep it out of the plug threads. Then a cavity was made for the blasting cap, and the plug assembly was screwed into place.

To use, the fuze was lit and the bomb thrown at or placed on the target. This is the bomb pictured in all of the old illustrations of lurking anarchists. If you can find a copy of Most's book, it is still entertaining reading more than a hundred years later.

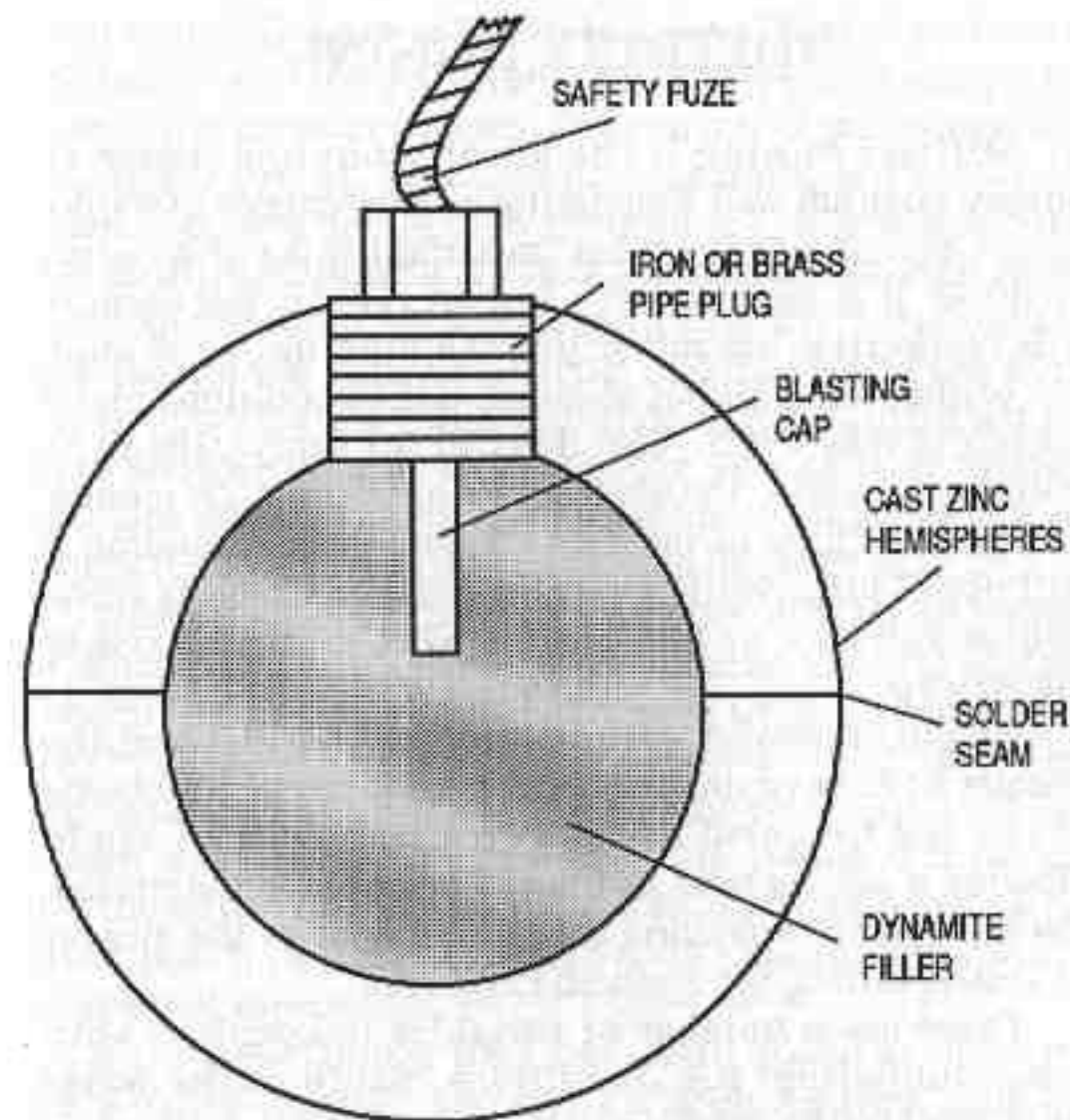

Nineteenth century anarchist's bomb.

MILITARY MINING

Military mining is the art of tunneling under an enemy position and detonating a large charge of explosive. Once one of the most important tasks of an army engineer, it is now almost a lost art. This is not because it is ineffective, but rather that the fluid tactics of modern warfare have all but eliminated the conditions under which it was used. The days of an army sitting in trenches a hundred yards from its opponents for months on end is a thing of the past. Nonetheless, tunneling is still useful for covertly attacking positions such as storehouses, barracks, or headquarters with minimum risk to the attacker.

Various terrorist groups, such as the IRA and the Basque ETA, have dabbled with road mining, but no one of late has tunneled under a structure with an eye to blowing it up. As near as I have been able to determine, the last time it was done was at the siege of the alcazar in Toledo during the Spanish Civil War.

There are a number of variables to consider with urban tunneling: soil conditions, depth of the water table, road traffic overhead, etc., not to mention the myriad of things that run underground, such as sewers, telephone lines, and gas pipes. The easiest way to avoid these is to go straight down to a depth of 20 to 25 feet before beginning your horizontal tunnel to the target. How much or how little you will need to shore your tunnel depends on the soil condition. The reason the Vietcong had such success with their tunnels was the heavy clay content of the soil in their area of operations—it set like concrete and didn't even need to be shored. On the other hand, the tunnel at Stalag Luft III was in soil with a heavy sand content. It was necessary to shore almost every foot of it.

If the shaft is too close to the water table, you may

have to install a sump pump to keep things dry. If your tunnel is very long you will have to ensure adequate ventilation for your diggers. Believe me, if this is needed you will know it. Working underground is hard even when you have enough air. If you don't, it is exhausting and downright painful. Attach a length of 3/4-inch hose to a compressor or air pump and run it up to the tunnel face (where the digging occurs). Lighting along the tunnel is nice, but it's optional. Your diggers just need to have enough light to work by. The size of your tunnel will also be dependent upon your circumstances. If it is higher than it is wide, it will be less likely to cave in.

When tunneling under a structure, always be aware of what types of pipe you are encountering. When the French Resistance tried to blow up a Gestapo headquarters by placing a charge in the sewer under it, they did not take this simple yet important precaution. The charge was placed next to a gas main. When it blew, so did the entire block. There were so many civilian casualties that it is said the Nazis didn't even bother with their usual reprisals.

If the opportunity presents itself, you may want to try a "blitz" tunnel, entering through a sewer pipe or storm drain. You cut through the wall and dig as fast as possible to the target site. If the tunnel is short—30 feet or less—you may not have to shore. If it is any longer you should dig a conventional shaft. The spoil (excavated dirt) may be disposed of in the sewer itself since you will ideally only be there a few hours. This is the least secure of all tunneling jobs.

You might want to try a method used by some enterprising bank burglars a few years ago. They used a small all-terrain vehicle (ATV) with a trailer to haul their heavy equipment (torches, core drill, etc.) up the storm drain to the tunnel site. It also made possible their speedy getaway when their entrance into the vault triggered the alarm. A good set of mufflers should be fitted.

For sawing through sewer walls, one of the quickest and neatest methods is to use a gas-powered chop saw with a diamond-impregnated blade. Always use the diamond blade. They are more expensive than the carbide ones, but they will cut through rebar like it doesn't even exist.

TUNNEL CONSTRUCTION

While you are contemplating the construction of your tunnel, I suggest you go to the library and check out a copy of *The Great Escape*, by Paul Brickhill. This is an interesting and highly informative account of the mass tunnel escape from Stalag Luft III in 1944. One of the most detailed accounts of covert tunneling available, it includes many helpful hints on what may occur and how to deal with it. Of course, you won't have the same problems of concealing your work from constantly prying eyes or making your own tools.

TUNNEL ENTRANCES

The best place to start a tunnel, from the viewpoint of security, is the basement of a private home or secure commercial firm. You must be able to work unobserved and have a safe place to store all the spoil from the tunnel. If the shaft is to be very long or large there will be lots of dirt to dispose of. You'll have to break through the floor with a pick axe, sledge hammer, or chop saw with diamond-impregnated blades. The latter is the fastest and neatest way to go if the concrete is not too thick.

Once you have your work area cleared, begin to dig the vertical shaft. Use buckets on ropes to carry out the excavated dirt. The first couple of cubic yards should be packed into sandbags for use as tamping when the charge is emplaced. Once you have reached the desired depth, enlarge the base of the shaft for use as your workroom. This is where you will store all of your tools, air pump, dirt tubs, and so on. If at all possible, both the workroom

and the vertical shaft should be heavily shored so that you have a safe place to go if your tunnel begins to collapse. This is also where your shovemen will be stationed.

TUNNEL SHAFT

The best size for a tunnel varies with the soil conditions, but one about 5 feet high and 3 feet wide is big enough to allow one man to work comfortably on his knees (don't forget your kneepads) while wielding a pick axe. The small army surplus pick works well in cramped quarters. One man can usually dig about a cubic yard of earth per hour. When this has been accomplished, he goes back to the workroom to rest while the shovelman moves forward with his tub to clear away the loose dirt and do any shoring necessary. Rounding the top of the tunnel will make it easier to get by without shoring. To a point, the narrower the tunnel, the less likely that cave-ins will occur.

When trying to decide the size of your tunnel, always bear in mind the size of the explosive packages you will be using. Trying to drag a 50-pound sack of ANFO through a 2x2 tunnel to the charge chamber tends to be a bit tiring. Try to make sure your floor is reasonably flat and solid. This will make it easier to use a hand truck both for disposal of the dirt and for carrying in the explosive charges. If your tunnel is very long—more than 75 to 100 feet, for instance—use a laser to sight along one wall to make sure it is straight and level. If you blow up the wrong building people are liable to talk badly about you.

CHARGE CHAMBER

Once your tunnel is the required length, begin digging upward until you make contact with the foundation of the target building. Be careful not to scrape your shovel across the concrete, as this makes quite a bit of noise. Noise discipline is very important at this point—

you would be surprised at how far sound will carry. Begin digging your charge chamber off to the side of the shaft. You should have already determined how much space the explosive charge will occupy. Make the chamber about 5 feet longer than needed. This makes tamping easier. If your target building is very long you may want to enlarge the charge chamber into what is known as a "coyote" tunnel. Dig two wings off to the sides of the charge chamber at 90-degree angles, parallel to the length of the building.

COMPUTING THE CHARGE SIZE

If total destruction of a heavily built structure is required, a good rule of thumb is to use about a quarter-pound of high explosive per square foot of floor area. In most cases you can get by with half this much. If you use a coyote tunnel, divide the charge into thirds.

With such large amounts of explosive required, ANFO is the best way to go. Prime with at least 10 percent conventional high explosive (HE), such as TNT or gelatin dynamite; 20 percent is better. An easy way to prepare bulk ANFO is to punch a hole in the top of the bag, insert a funnel, and pour in the required amount of diesel or fuel oil (1 quart oil per 25 pounds AN). Slap a square of duct tape over the hole and turn the bag over several times to get it evenly mixed. Rather than prime every bag, as is common practice, place all your HE in one package and stack the ANFO bags on top of it. This will direct the detonation waves upward.

EMPLACING THE CHARGE

Once the chamber is ready, prime one of the explosive packages, place it on the bottom, and stack the rest of the charge on top of it. The shock wave of the explosion will travel upwards into the target. The tamping in this case is not confining, but rather channeling the force of the blast. Stack the prepared sandbags in the

rest of the charge chamber until full. Reel the firing wire out of the tunnel to the firing site.

When the charge is detonated, most of the explosive force will go straight up into the target. Some of it, especially if it was improperly tamped, will come up the tunnel looking for you. Don't be near the entrance when this happens. The shorter the tunnel, the greater the chance of this occurring.



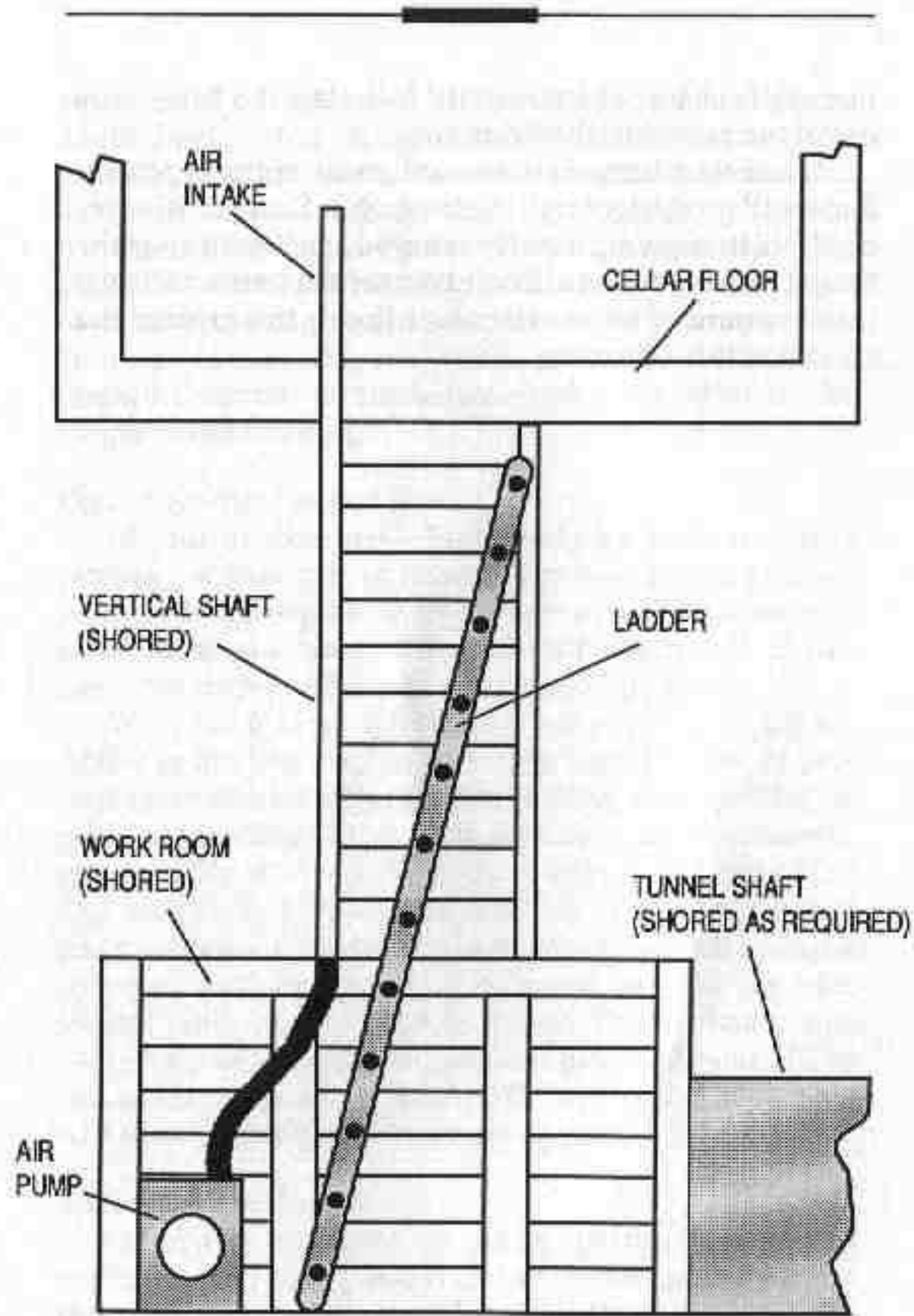

Tunnel entrance (not to scale—exaggerated for clarity).

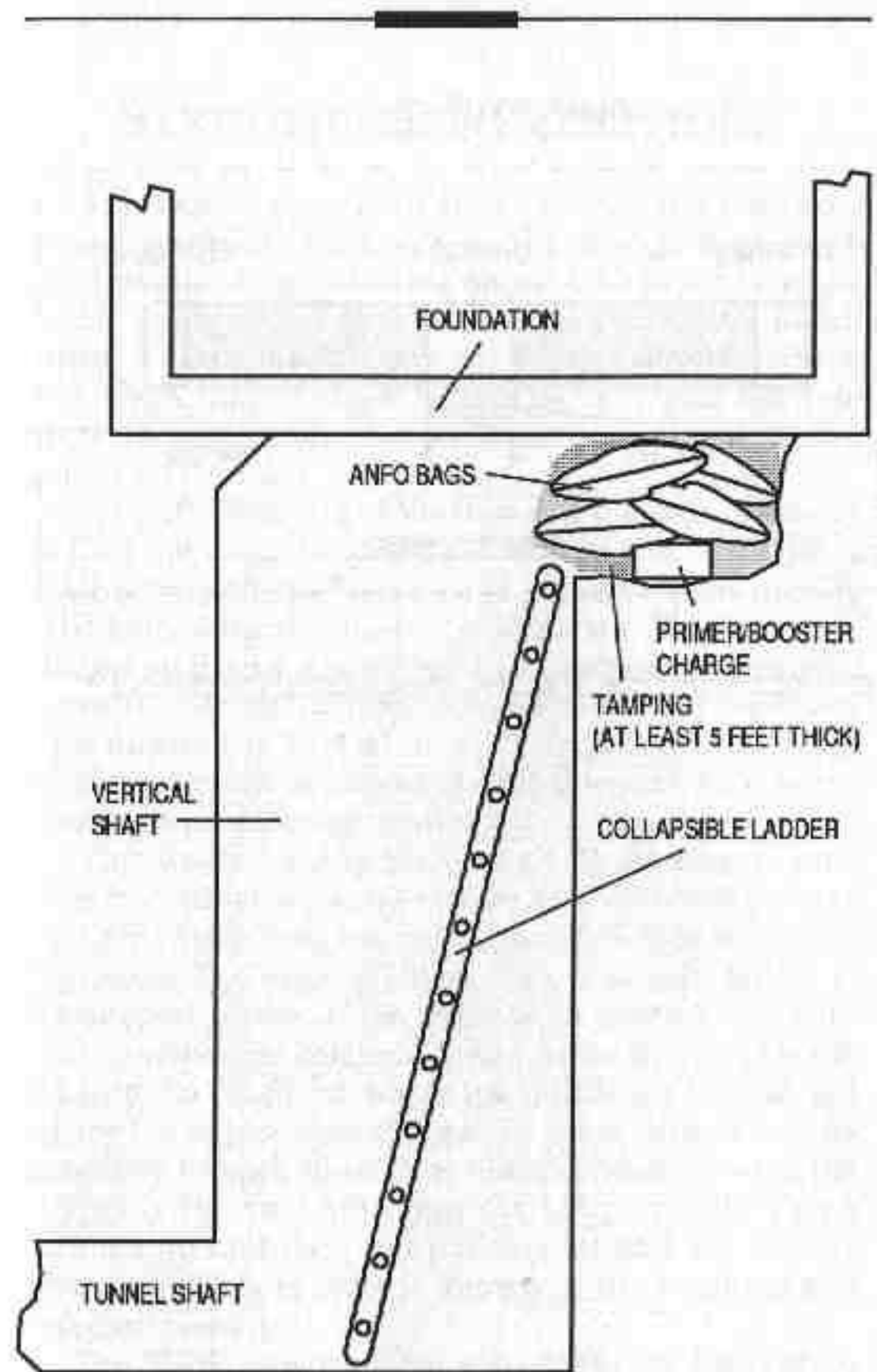

Charge chamber details (not to scale—exaggerated for clarity).

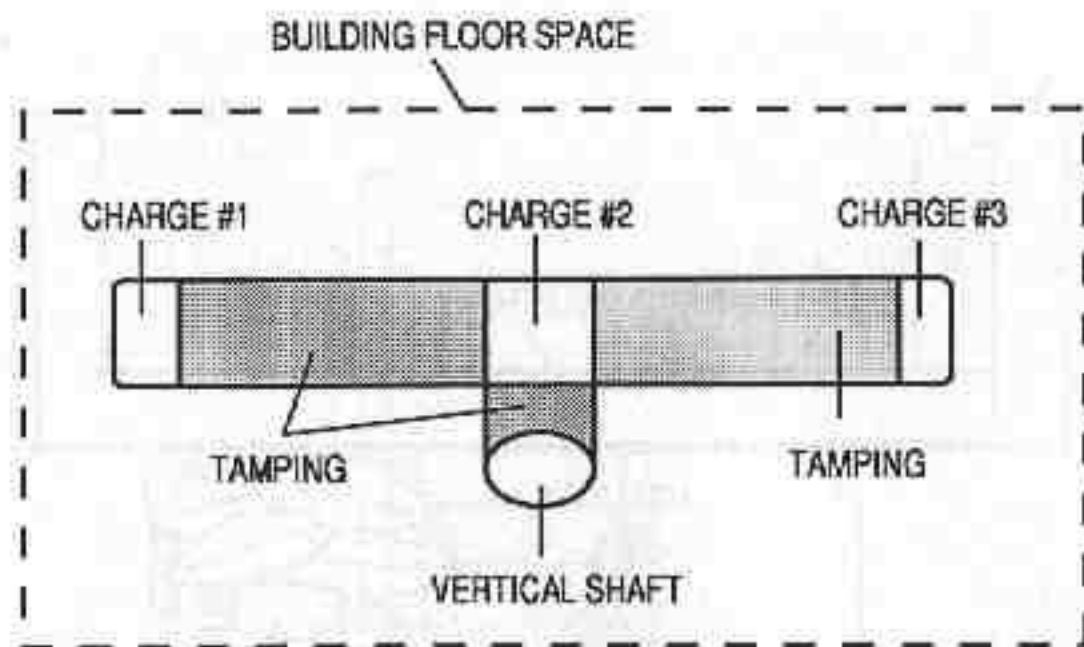

Coyote tunnel (not to scale—exaggerated for clarity).

STRUCTURAL DEMOLITIONS

This can be one of the most difficult and time-consuming methods of demolition. The average large building presents an intimidating target. One factor is in our favor, however—all buildings desperately want to fall down. It takes the skills of engineers and architects to keep them from doing so. The trick is to kick the supports out from under the structure and let weight and gravity do the rest.

A careful analysis of the building plans is necessary to find the main supports and devise the best way of dealing with them. Professional demolitionists usually drill holes into the support pillars, use linear-shaped charges on beams, and cut away all unnecessary material to enable them to use the minimum amount of explosive. This allows the best of them to drop large buildings without so much as bouncing a brick across the street or breaking a neighboring window.

This doesn't really concern us. If the target is too close to civilian areas, we simply find something else to do. Other than this, our only concern is that the building drops. The main problem is how to gain access to the support pillars. If the target is an office building or other commercial concern, it may be as simple as walking into the basement where the pillars are located and setting the appropriate charges. In some cases it may be necessary to hack through an interior wall to reach the supports. In some buildings the support pillars pass through an underground parking lot and are readily accessible. This is what is known in the business as a best-case scenario.

The ERDL square charge is probably the best choice in this instance, unless the pillars are of such a size and shape (i.e., substantially square and 4 feet or less in thickness) as to allow the use of the counterforce or

"earmuff" charge. This is the most economical method short of drilling the pillars for internal charges. You will only have to knock out about 75 percent of the supports to cause the building to collapse. Of course, if your target is a military building or police station, extreme guile or force may be required simply to get inside and place the charges—not to mention getting back out. (You knew the job was dangerous when you took it.) Mining from below is the safest way to deal with a target such as this.

Make a habit of inspecting any large building sites that may crop up in your area. Go by every week or so to check on progress and note the size and number of support pillars, how they are covered as the construction progresses, and so forth. How would you deal with such a building if it became your target? Doing this takes much of the mystery out of this procedure. Don't worry too much about people noticing your interest. This is a case where widespread interest is a natural, everyday thing. Feel free to ask questions as long as they are not like, "What would it take to drop this baby?" Use common sense.

TIPS: ERDL charges can be mounted on the support pillars by firing a nail into the concrete using a "Hilti" gun or similar device and hanging the charge on it. Connect the charges with det cord. If the building is steel-framed, use a simple ribbon charge to cut the beams.

Mass-construction buildings are those in which the outside walls support the weight of the building and its contents. Older mass-construction buildings were usually made of thick brick or stone walls. They normally have thicker walls and fewer windows than framed buildings. The windows must be aligned vertically so the walls can support the weight of the building.

Mass-construction buildings are very difficult to drop and will require a large expenditure of explosive, not to mention the risk involved. The most economical way is to drill charge chambers in the walls. For obvious

PRINCIPAL BUILDING CHARACTERISTICS OF FRAMED AND FRAMELESS BUILDINGS

TYPE OF CONSTRUCTION	BUILDING MATERIAL	HEIGHT (STORIES)	AVERAGE WALL THICKNESS (CM)
Mass	Stone	1-10	75
Mass	Brick	1-3	22
Mass	Brick	3-5	38
Mass	Concrete Block	1-5	20
Mass	Concrete Wall and Slab	1-10	22-38
Mass	Concrete "Tilt Ups"	1-3	18
Framed	Wood	1-5	3
Framed	Steel (Heavy Cladding)	3-50	3"
Framed	Concrete/Steel (Light Cladding)	3-100	2-8

The two basic types of building construction are mass (or frameless) and framed.

reasons, this is rarely possible. The only other way to go is to use breaching charges such as the ERDL. You will need to know the thickness of the walls to calculate their weight and placement. Place six of these at the corners, three on each side, and one between each window along the sides. This will usually result in the collapse of the structure. It does have the advantage of not requiring internal access to the building; unfortunately, it is also rather obvious what you are doing. Connect all charges with det cord for simultaneous detonation.

Modern types of mass-construction buildings are wall and slab structures, such as many modern apartments and hotels, and tilt-up structures commonly used for industry or storage. The latter type usually has few windows and is best dealt with using a fuel-air explosive (FAE) charge.

Framed buildings are those supported by a skeleton

of columns and beams. They are usually taller than frameless buildings. The exterior walls are not load-bearing and are referred to as either heavy-clad or light-clad. Heavy-clad walls were common when framed buildings were first introduced. These are made of brick and block and in some cases are almost as thick as frameless brick walls, although not as sturdy. Light-clad walls are more modern and usually consist of nothing more than glass. This type of building is best dealt with by using cutting charges on the beams and columns, as previously mentioned.

FRAMED BUILDING SKELETON



HEAVY-CLAD WALLS

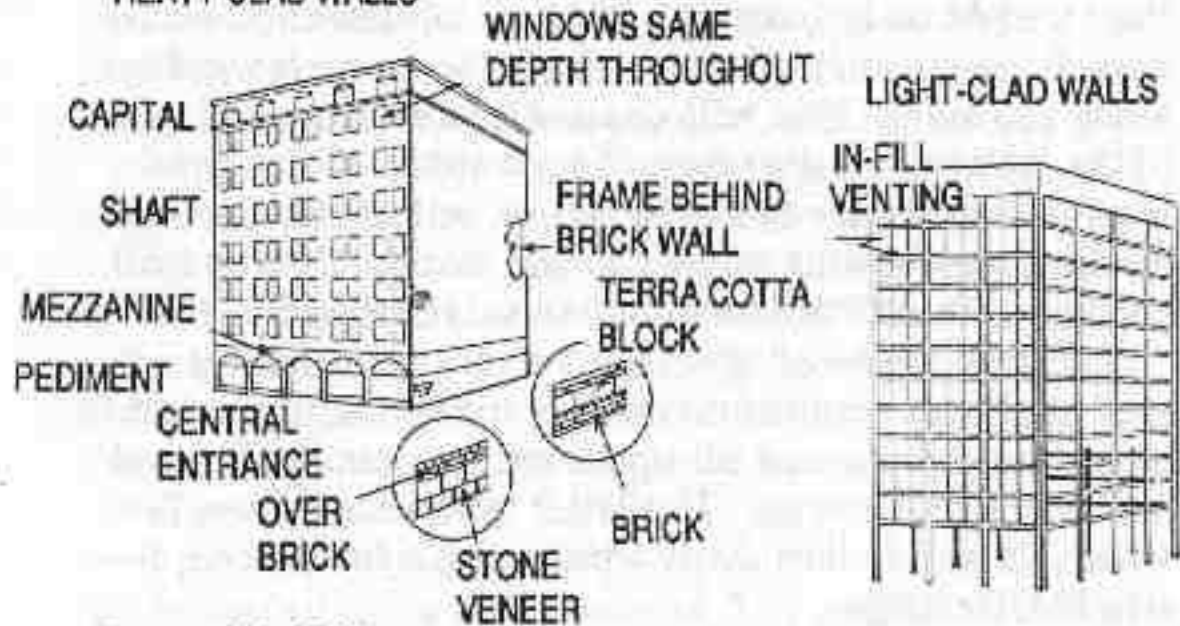

Framed buildings.

MASS-CONSTRUCTION BRICK BUILDING

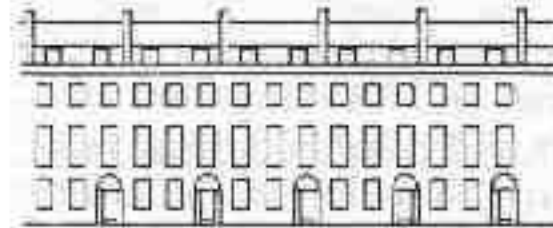

SMALL VERTICALLY ALIGNED WINDOWS
THICKER LOWER STORY WALLS

WALL AND SLAB BUILDING

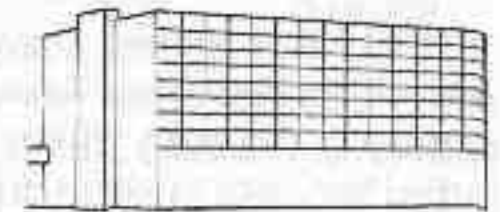

MASS-CONSTRUCTION STONE BUILDING



THICK WALLS
DEEPLY RECESSED WINDOWS

TILT-UP BUILDING

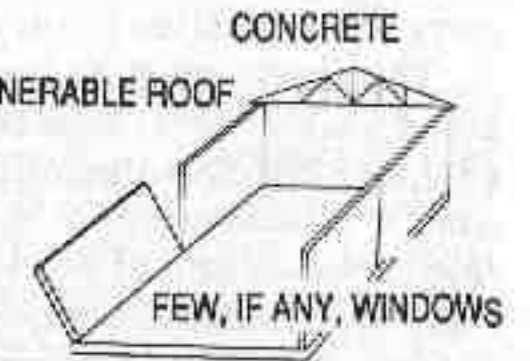

Mass buildings.

ERDL SQUARE CHARGE

The ERDL square charge was developed at the U.S. Army's Engineering Research and Development Laboratory in the early 1960s. It will reliably destroy reinforced concrete targets with walls up to 7 feet thick with considerably less explosive than is normally needed. As an example of the effectiveness of this technique, our target will be a 4-foot-thick wall. Using the square charge, 50 pounds of composition C-4 is required. This same wall, using the old formulas, would require 70 pounds of C-4 to demolish it, or an increase of 40 percent. This makes a big difference when you have to carry the explosives in on your back.

The charge must be approximately square, and either 2 or 4 inches thick. This corresponds with the thickness of the old M-5A1 demolition block (C-4) in use at the time it was developed. It must be primed in the exact rear center or one of the four corners. If your target is a wall, several charges may be used to blow down a larger section of it. The number of charges required may be computed using the formula $N=W/2R$. (N = number of charges, W = width of target, and $2R$ = 2 times the breaching radius of the charge.) Thus, if you had a 4-foot-thick reinforced concrete wall 20 feet in length, you would use three (rounded up from 2.5) 50-pound charges, spaced 8 feet apart (2 times breaching radius), 4 feet above the ground (equal to breaching radius).

CHARGE CHART FOR ERDL SQUARE CHARGE

CONCRETE THICKNESS	CHARGE SIZE (APPROXIMATE)	CHARGE WEIGHT (POUNDS)	CHARGE THICKNESS
1'	6 1/2" x 6 1/2"	5	2"
2'	9 1/2" x 9 1/2"	10	2"
3'	12 1/2" x 12 1/2"	17.5	2"
4'	21" x 21"	50	2"
5'	23" x 23"	120	4"
6'	26 1/2" x 26 1/2"	160	4"
7'	32 1/2" x 32 1/2"	240	4"

Example: Target is section of wall 24' long, 8' high, and 4' thick.

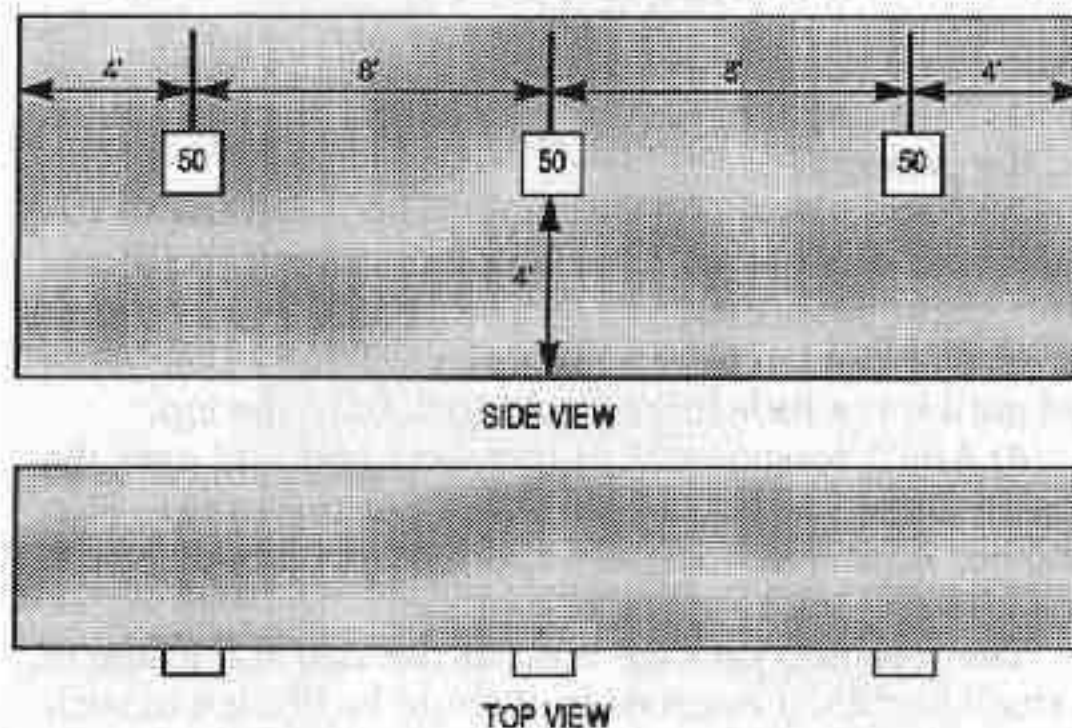

BABY BOTTLE BOMB

This is an incendiary device that is small and very effective. It uses napalm B and naphthalene moth crystals as its fuel. When naphthalene is heated to a high temperature it emits a gas that ignites spontaneously with the air and burns at a very high temperature. The fuel gel is housed in a plastic baby bottle liner, as is used in disposable infant nursers. These liners will hold 6 to 7 ounces of filler.

First prepare a batch of napalm B. This is done easily by dissolving Styrofoam chunks in gasoline until no liquid remains. The ratio is about one part gas to one part Styrofoam by weight. (Don't try to make the napalm B in a bottle. It will only make you crazy).

PROCEDURE:

1) Place the liner in the baby bottle frame as shown on the package.

2) Place 3 teaspoons of naphthalene crystals in the bottom and cover with enough napalm gel to fill the liner slightly less than half full.

3) Add 3 more teaspoons of naphthalene, then more gel until it is a little more than 1 inch from the top.

4) Add 1 teaspoon of naphthalene and fold over the top to close the liner. Seal this with duct tape. Slip another liner over the packet in the opposite direction and also seal with duct tape.

The resulting package is about the size and shape of a small burrito. (Conceivably, it could be hidden in such a wrapping to prevent detection. Just hope they don't take a smell of it.) It will ignite quickly upon application of a match, but use of a delay packet is advised. Long storage of this device is not recommended, as the filler will seep through the pores in the plastic over time.

LINER IN BOTTLE FRAME - READY TO FILL

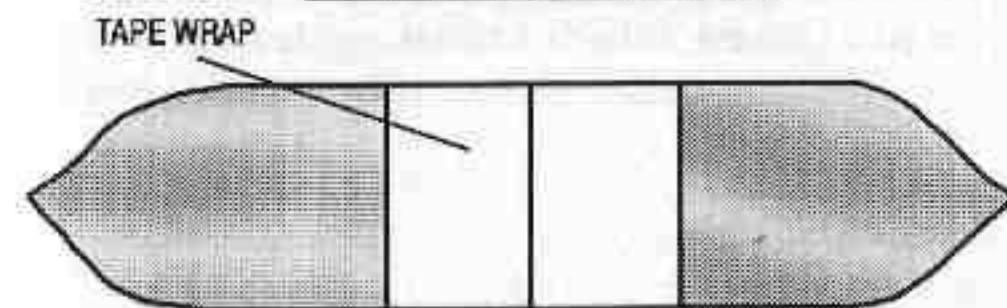
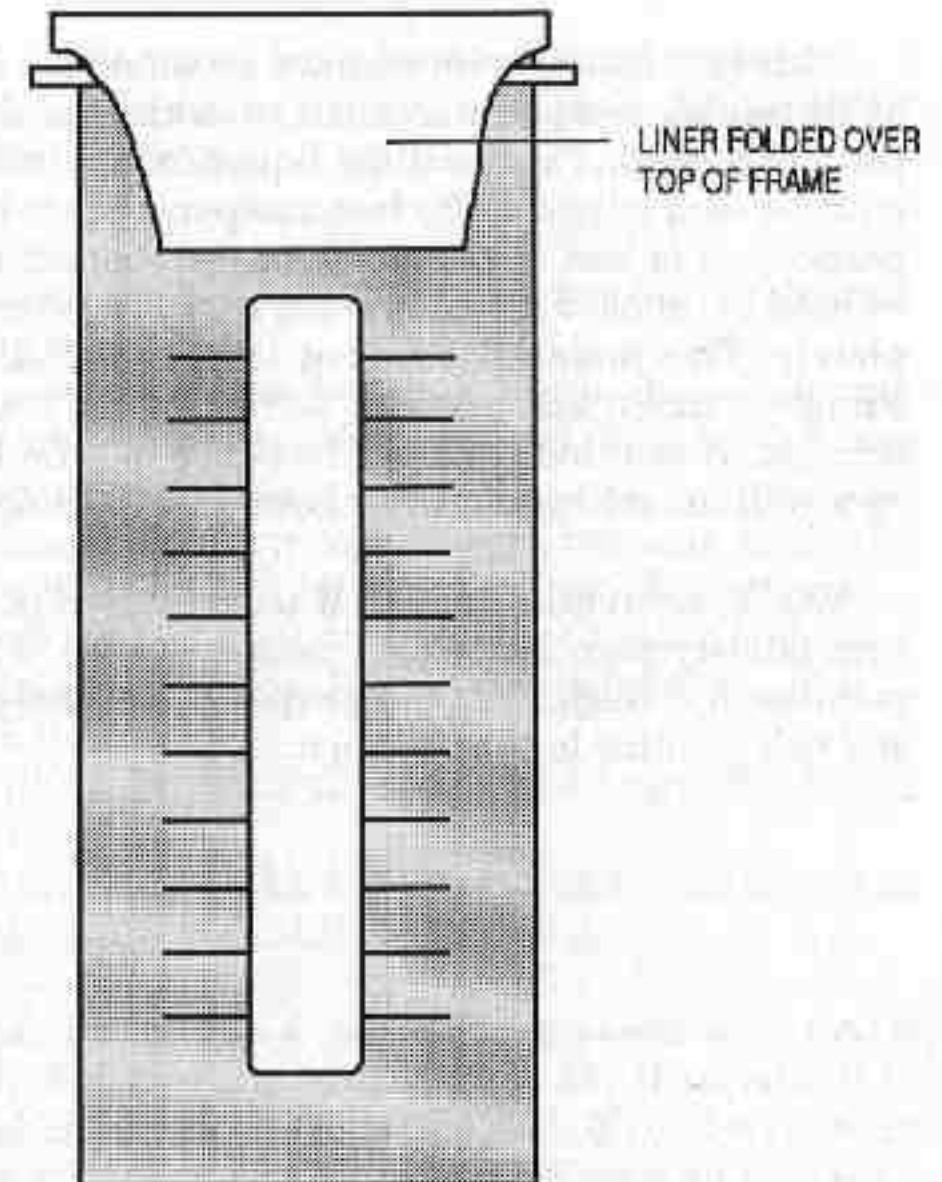

COMPLETED DEVICE

Baby bottle bomb.

NAPALM B-N

This is a fantastic incendiary substance. It is made by dissolving one part naphthalene moth crystals in two parts napalm B. The resulting liquid is very sticky and must be well stirred if the two components are to blend properly. It is best to prepare it in the container it is to be used in, as once mixed it is too sticky to remove completely. This material burns at least twice as long as straight napalm and is much hotter. Rather than a viscous gel, it is a thick syrup, like honey or STP. It works very well in mollies and other hand-thrown firebombs.

NOTE: Currently, napalm B is comprised of 46 percent polystyrene, 21 percent benzene, and 33 percent gasoline, by weight. For our purposes, half polystyrene and half gasoline is close enough.

JAR MOLLY

This device consists of a 1-quart jar of napalm B with a 1/4-inch cotton rope as a wick. It throws better than a conventional molly made from a bottle.

PROCEDURE:

- 1) Punch a 1/4-inch hole in the lid of the jar. Remove any sharp edges.
- 2) Take a length of 1/4-inch cotton rope, 6 inches long, and tie a tight knot on one end. (No, I don't care what kind of knot it is.)
- 3) Thread the other end through the hole in the lid and tie another knot about 4 inches from the first one.
- 4) Pull the first knot down tight on the lid and cover with a strip of duct tape. Fold the end of the tape over to form a pull tab.
- 5) Fill the jar with napalm B and screw the lid on tightly.

To use, remove the tape cover and withdraw the fuel-soaked rope wick. Light and throw.

NOTE: Do not use a synthetic rope such as nylon. It will drip hot burning plastic when lit. If napalm B is unavailable, use any good gelled fuel. If the fuel is very thin it may cause excessive leakage around the wick hole. If leakage around the lid seems to be a problem, seal this area with silicone sealer.

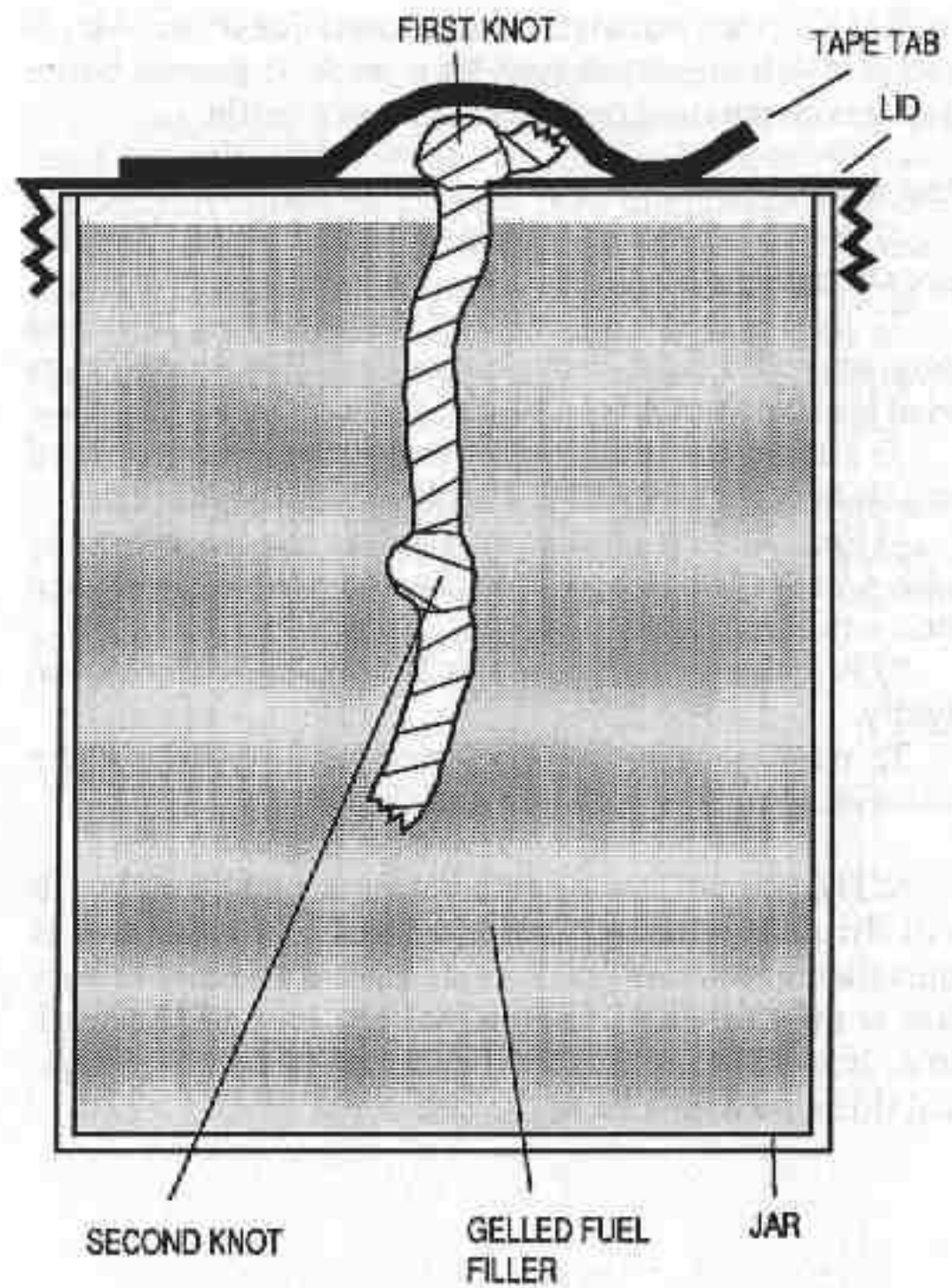

Jar molly.

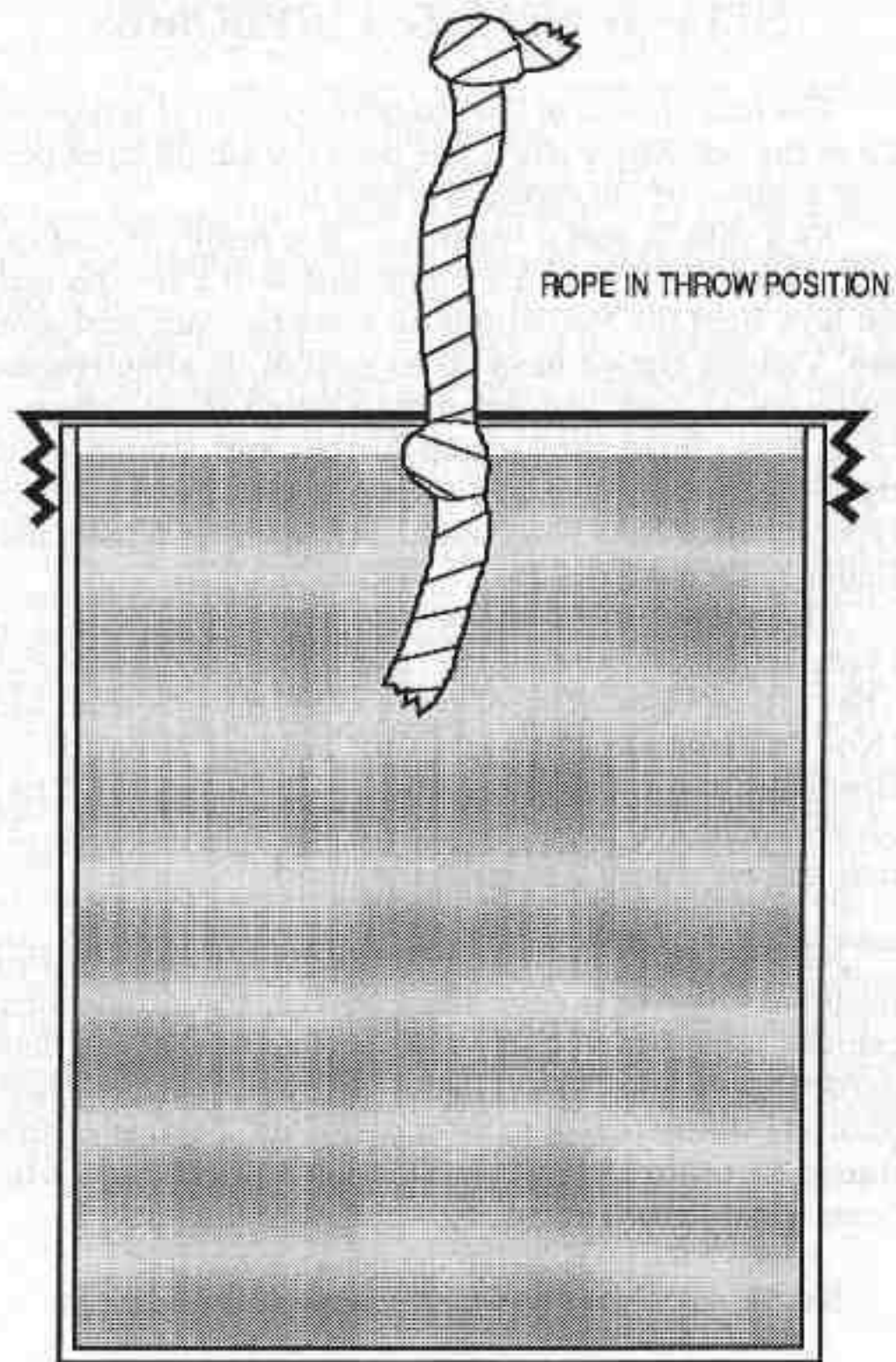

Jar molly, ready to throw.

SELF-IGNITING FIREBOMBS

The exact origin of the Molotov cocktail is unknown. Over the last fifty years it has been the single most popular weapon of insurgents worldwide.

As a rule, it was a weapon of last resort, as one can always find bottles and a liquid that will burn, no matter how tight the restrictions on more conventional arms are. Various armies have taken note of its effectiveness and have, at least, instructed their troops in its construction. Some have gone a step further and attempted to develop Molotov cocktails as production items. Various types of fuzes have been tested, but none have been particularly successful.

The following section contains three kinds of fuzes—chemical, mechanical, and chemical-mechanical. They are representative of types used, ranging from bad (No. 76 Grenade) to excellent (Fieser Incendiary Grenade), with a stop in between for marginal. They give a reference point for where we have been in the past and where we may go in the future.

NOTE: Credit for the invention of the self-igniting firebomb may well go to the Fenians, the nineteenth-century forebears of today's IRA. "Fenian fire," as their particular version was called, consisted of white phosphorous dissolved in carbon disulfide. Bottles of this liquid were thrown down chimneys or through windows to set houses afire.

NO. 76 SELF-IGNITING PHOSPHOROUS (SIP) GRENADE

The SIP grenade was a Molotov cocktail-type weapon developed early in World War II. It consisted of a common 1-pint glass bottle containing a mixture of benzene, water, white phosphorus, and a strip of raw rubber. The

rubber strip became quite soft and sticky from contact with the benzene, and this gave it some adhesive qualities in use. Ideally, the grenade ignited spontaneously when hurled against a tank or other target.

The SIP's manufacturer originally intended to use it to demonstrate the incendiary qualities of his mixture, but it apparently caught the fancy of certain higher-ups, who ordered the military to test it for possible adoption. It was tested by various branches of the British military, all of whom hated it (with no small justification, I might add—if you drop it, it ignites). It finally came to rest with the British Home Guard, who received it enthusiastically. They had always had a soft spot for weapons of this type.

The SIP was cheap and easy to produce, but it had several drawbacks: 1) due to its design, any accidental breakage during handling could prove disastrous; 2) at low temperatures it was slow to ignite; and 3) 1 pint is too small for an effective firebomb. It was spectacular, smoky, and usually quite ineffective. It was also adopted by the British army as a substitute standard weapon until something better came along. When something did, it was discarded as soon as possible, but it was not declared obsolete officially until 1944. In anticipation of the German invasion that never came, the Home Guard buried caches of these weapons, which still pop up at the most inopportune times. It usually occurs when a bulldozer is clearing land for a building project and rips up the cache. This is what we in the business call a "surprise."

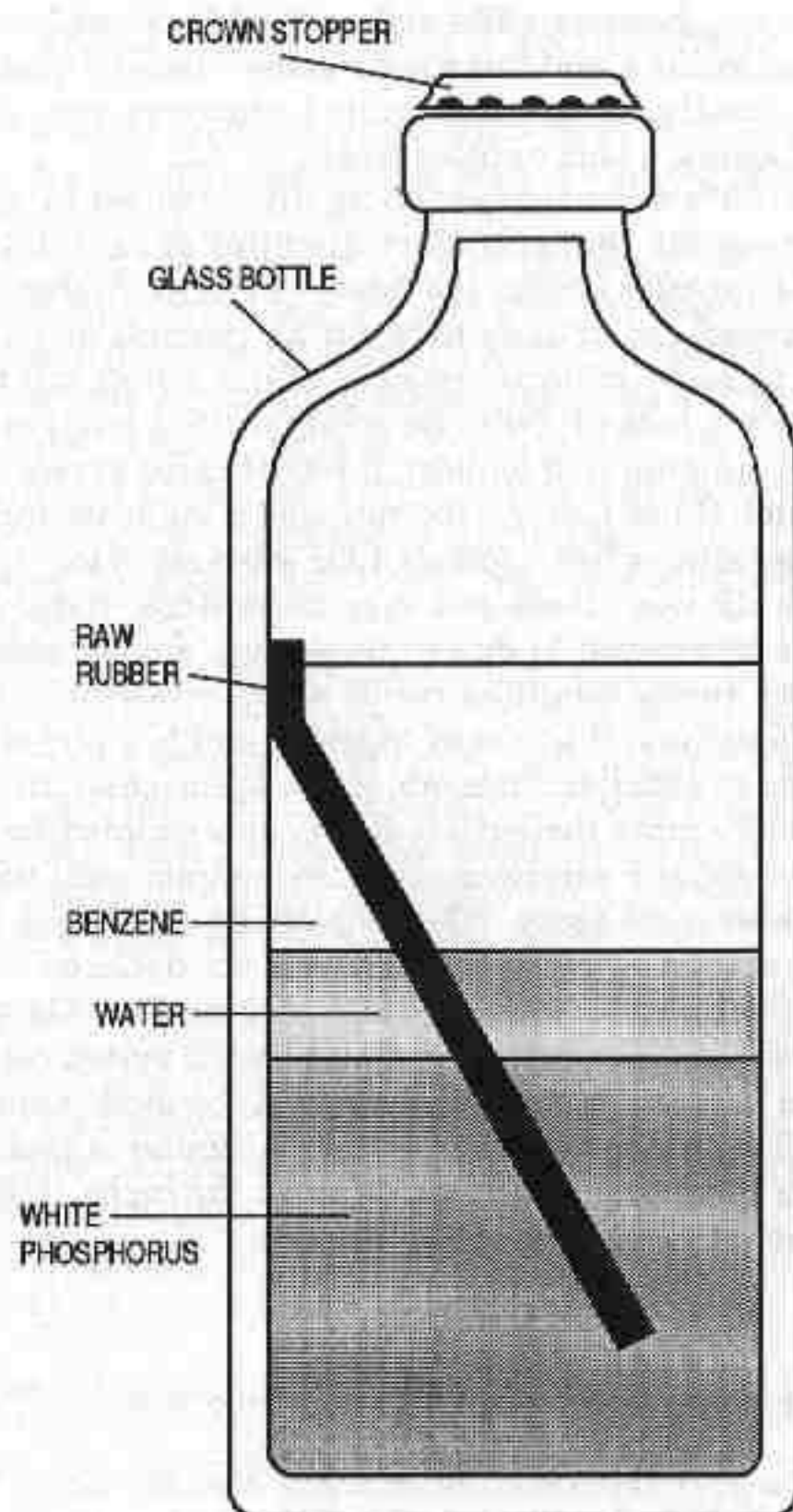

No. 76 Self-Igniting Phosphorous Grenade, actual size.

JAPANESE IMPACT IGNITION FIREBOMB

This device was developed by the Japanese for the primarily jungle combat of the Pacific Theater of Operations. Due to the lack of many things hard enough to break the bottle in the average jungle, they reasoned that an impact ignition fuze would be most effective.

The fuze itself consisted of a brass body containing a striker/percussion cap assembly, a hair spring, and a safety nail. Upon impact, the inertia of the striker would overcome the resistance of the hair spring and fire the percussion cap, which in turn fired the detonator. It was similar in many respects to the British "All-ways" fuze used in the Gammon grenade, but it lacked the delay arming feature of that fuze. Once the safety nail was removed, it was armed. Any rough or sudden movement could cause the fuze to function.

The bottles were usually supplied empty for field-loading and were of about 1-pint capacity. They were shaped like an ordinary Japanese beer bottle and had detailed instructions pasted on the side. Shipped in cases of twenty-four, they were also supplied with a small wooden funnel for loading and twenty-four fuzes, individually packed in small aluminum cans. Captured examples were tested and proved to be unimpressive. In many cases the detonator would break the bottle but not ignite the fuel. High explosives are not always effective in setting fire to flammable liquids. It would have been better to use a slightly larger charge of firecracker flash powder as opposed to the tiny (1/4 "XF") detonator that was employed. This type of fuze, if developed further for improved function and ease of manufacture, could be very useful.

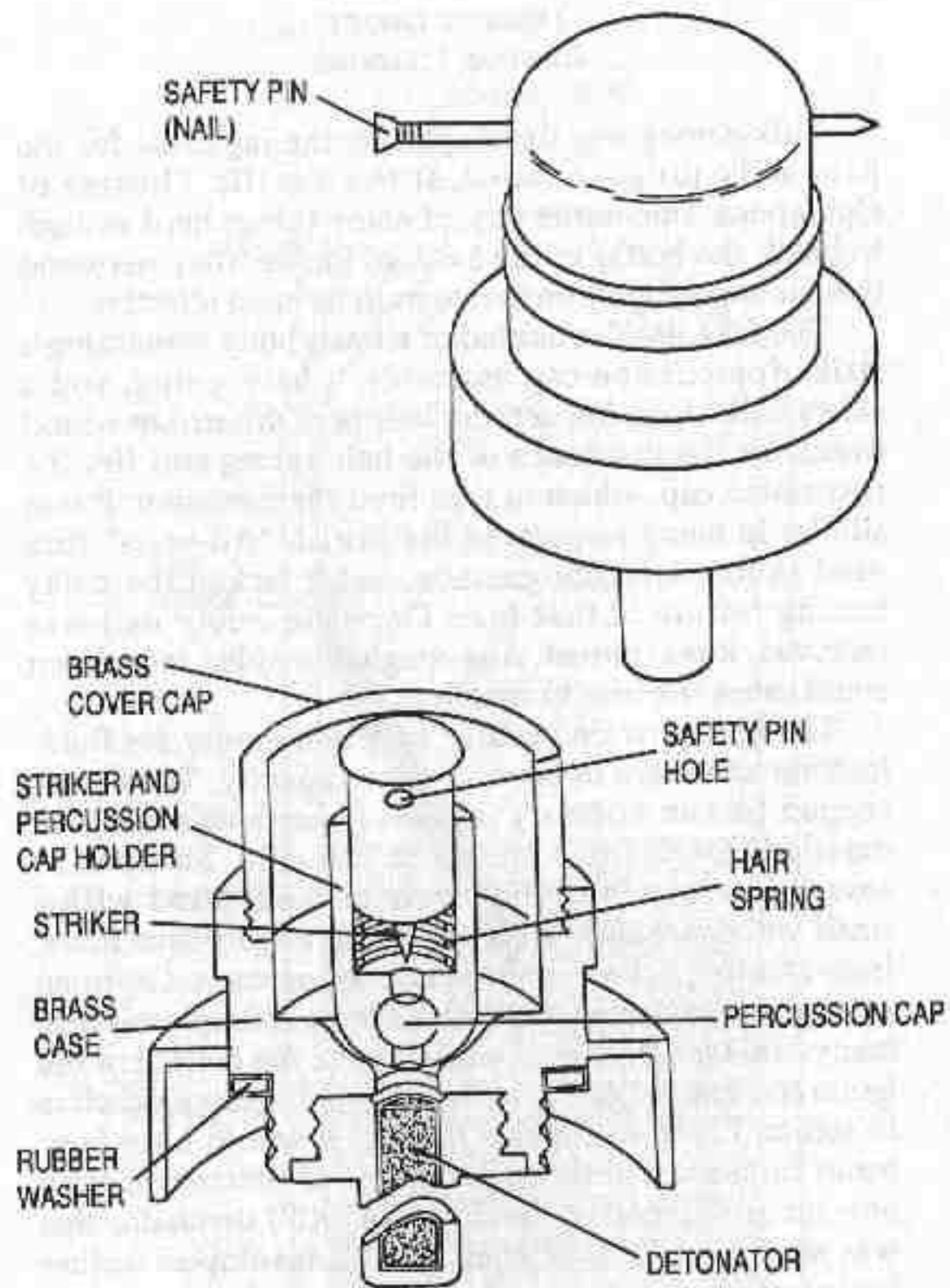

Japanese impact ignition Molotov fuze.

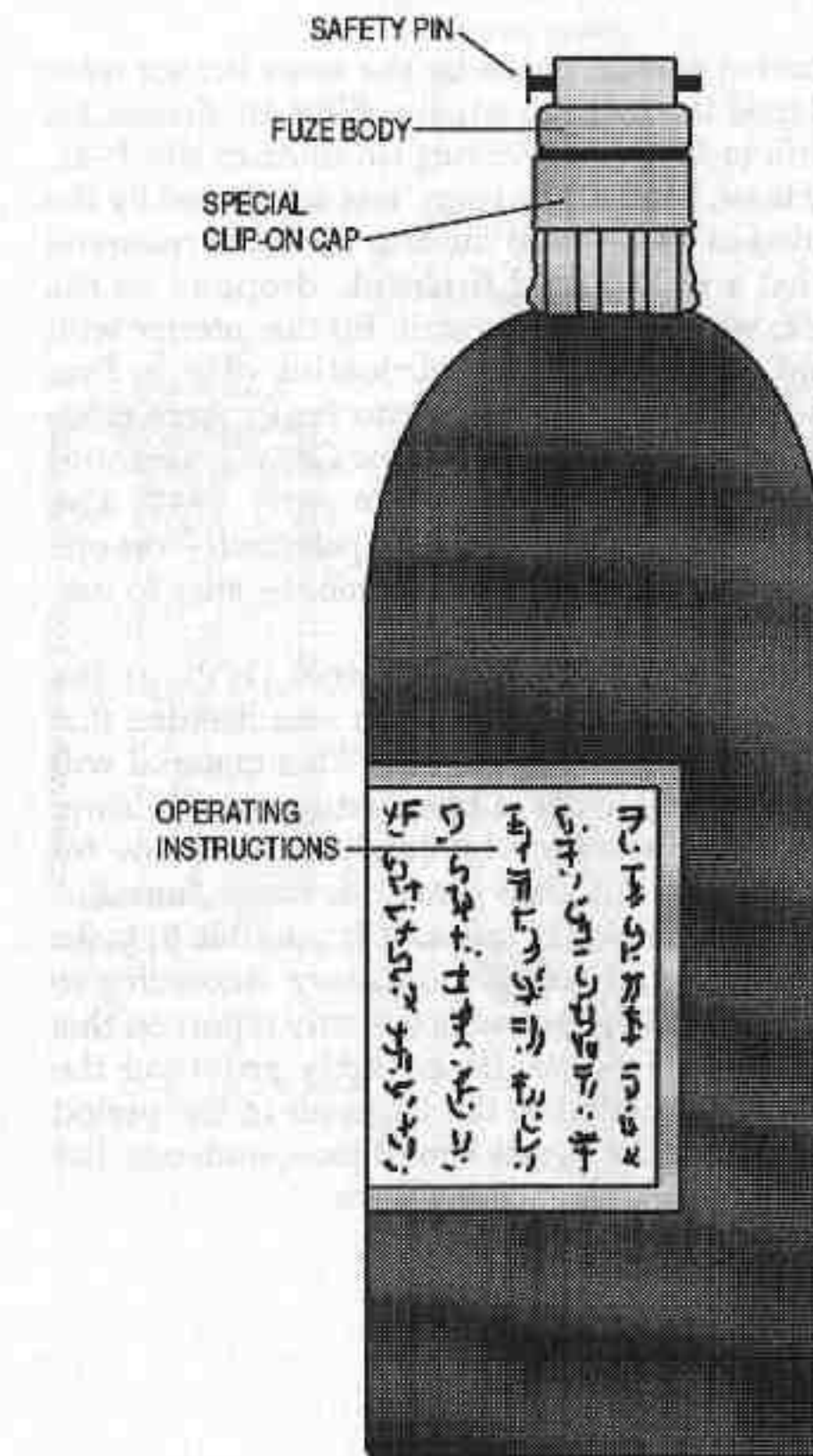

WWII Japanese self-igniting firebomb.

L.F. FIESER INCENDIARY GRENADE

This device was invented by the same design team that developed the original napalm filler for firebombs. During a trip to Aberdeen Proving Grounds in late 1941, Dr. Louis Fieser, head of the team, was impressed by the large air intakes on a (then) modern tank. He reasoned (rightly) that a well-placed firebomb, dropped on the engine deck, would cause it to stall, fill the interior with smoke, and possibly set the lubricating oils on fire. Though it was noted that American tanks were more vulnerable in this respect than their German counterparts, development was started in early 1942. The device they came up with—and later patented—was one of the best of its type. It was safe to handle, easy to use, and, best of all, self-igniting.

Rather than use white phosphorus (WP), as the British did in their No. 76 grenade, it was decided that diethyl zinc would be more suitable. This material will ignite spontaneously in air at temperatures much lower than WP. A small number of grenades were made for testing by the army but were turned down as "unsafe." Though this grenade was as safe as it is possible to make this type of weapon, it faded into history. According to Dr. Fieser, the text of the patent is the only report on this weapon still in existence. He covertly provided the details of its construction to the Haganah in the period immediately before the Israeli War of Independence, but no details of its employment are known.

March 28, 1950

L. F. FIESER ET AL
INCENDIARY GRENADE
Filed Feb. 21, 1944

2,501,766

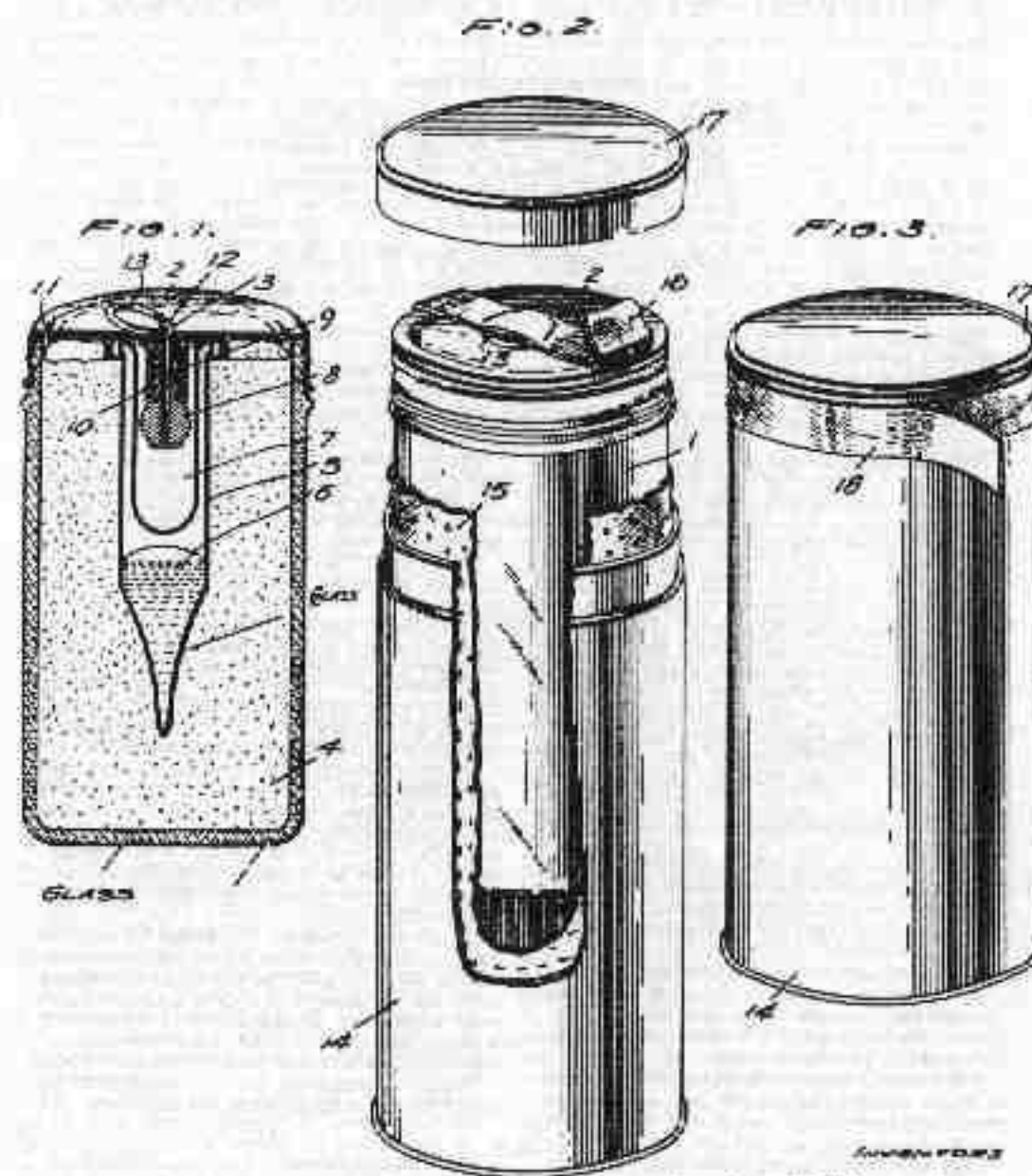

Louis F. Fieser
George C. Harris
Emanuel B. Hershberg
Morley Morgana
Frederick C. Novello
Stearns T. Putnam
Fred S. Lockwood
ATTORNEY

L.F. Fieser et. al. incendiary grenade. U.S. Patent filed February 21, 1944.

UNITED STATES PATENT OFFICE

2,501,766

INCENDIARY GRENADE

Louis F. Hieser, Belmont, Mass., George C. Harris, Wilmington, Del., Emanuel B. Hershberg, Stoughton, Mass., Morley Mergans, Grosse Pointe, Mich., Frederick C. Novillo, Lansdowne, Pa., and Steven T. Putnam, Newark, Del., assignors to the United States of America as represented by the Secretary of War

Application February 21, 1944, Serial No. 523,266

3 Claims (Cl. 105-45)

The invention described herein may be manufactured and used by or for the Government for governmental purposes without the payment to us of any royalty thereon.

This invention relates particularly to an incendiary grenade adapted for throwing by hand.

Various incendiary devices are known which can be thrown by hand, ejected mechanically or pushed by a propellant, and which ignite through the operation of a fuse mechanism or after impact on a target. The "Molotov cocktail" in its crudest form is a glass bottle crumpled with cotton waste soaked in gasoline, which can be lighted with a match prior to being thrown. One development consisted in the addition of a charge of white phosphorus as an igniter, but this has the serious disadvantage of being slow in action, particularly at low temperatures, and of being unduly hazardous. Another development provided a time fuse, but this suffers the disadvantage that the predetermined time often only occasionally coincides with the actual time of impact on a target. The same limitation is inherent in incendiary grenades of the thermite type.

An object of this invention is to provide a frangible type grenade safe to handle but which, upon receiving a predetermined adequate impact force when armed, is shattered and effects simultaneously a release of chemical substances that instantaneously give an intense incendiary action.

Another object of this invention is to provide an incendiary grenade which, upon receiving adequate impact when armed, is quick to action even at extremely low temperatures.

A further object is to provide a munition which is simple to manufacture, which can be transported with reasonable safety and which gives highly reliable performance.

The invention herein described is an improvement of the "Molotov cocktail" and has many advantages over the known types of frangible and other incendiary grenades. In a preferred specific embodiment, it consists in a glass container for a suitable carbonaceous fuel, preferably a thickened or sticky, gelled gasoline of desired characteristics, a separate glass ampoule charged with an igniting fluid which is spontaneously inflammable in air, and a device which can be manipulated into a position to effect release of the igniting fluid upon adequate impact. The unit is so designed that it can be shipped safely and carried in the field without danger. When required for use, it can be armed and will give

instant and positive ignition when impacted onto a target.

A suitable construction of the grenade is diagrammatically illustrated in the drawing.

Figure 1 illustrates a vertical cross-section view of the grenade proper.

Figure 2 illustrates in perspective an elevational view of the grenade proper in construction and partial assembly with a protective casing and cover, the partial assembly being shown with a portion in section.

Figure 3 illustrates a perspective view of the grenade assembled with its protective casing and cover.

Referring to the drawing, and particularly to Figures 1 and 2, the fuel container 1 is a glass jar having a volume capacity of about ½ pint to about one quart. The container is made from a frangible material strong enough to resist breaking up to a certain point, e. g., until dropped 7 feet onto a hardwood floor when filled.

Attached to the jar is a screw cap 2 of ordinary commercial design except for a small central aperture 3. The cap may be made of any material which satisfactorily resists corrosion on the inside by the fuel and on the outside by weathering, e. g., coke plate lined on the inside and lacquered on the outside, fuel-resistant plastic, and the like.

A preferred incendiary fuel filling 4 is a gelled gasoline, for example, an 8% to 3% gel of aluminum soaps in gasoline, the soaps comprising preferably an aluminum soap of saturated fatty acids having from about 8 to 14 carbon atoms per molecule together with an aluminum soap of naphthenic acids and/or unsaturated fatty acids.

Typical formulations for the preparation of thickeners and gelling agents are as follows:

- (1)
 - 1 part—Aluminum soap of coconut oil acids or aluminum laurate
 - 1 part—Aluminum naphthenate
- (2)
 - 1 part—Aluminum soap of coconut oil acids or aluminum laurate
 - 1 part—Aluminum oleate
- (3)
 - 2 parts—Aluminum soap of coconut oil acids or aluminum laurate
 - 1 part—Aluminum naphthenate

A glass ampoule 5 is charged with an igniting fluid which is spontaneously inflammable in air.

This ampoule may be made from two concentric tubes joined as shown by a ring seal at the top; the outer tube being sealed at the narrow bottom tip after the fluid is introduced. The double-walled ampoule thus has a Dewar bulb form and is hermetically sealed. The igniting fluid 6 is in a space between the two tubes or walls, and the concave side of the inner tube 7 forms a recess. Satisfactory igniting fluids include diacetylene, triethylborane and other substances, particularly organic-metallic compounds, which remain liquid at about -40° F. and which burst into flame on exposure to air.

The breaking of the ampoule 5 on impact of the grenade on a target is insured by inclusion of a small hard fracturing body, such as a steel ball 8 within the recess on the concave side of the inner tube 7. The metal ball 8 of fracturing body is secured in a safe position by a cotter pin 9; and until this pin is withdrawn, there is no danger of breaking the ampoule 5 on accidental jarring or accidental dropping of the unit. When the pin 9 is withdrawn and the grenade, thereby deliberately armed, the ball 8 will invariably fracture the ampoule 5 on an adequate impact of the unit, with resulting release of the igniting fluid and ignition of the fuel charge. The ball 8 is mounted at the end of a short section of a fiber tube 10, cemented to the screw cap 2 of the jar container. The ampoule containing the igniting fluid is attached as follows: a section of a fiber tube 11 of larger diameter than the outside diameter of the ampoule is cemented to the screw cap placed in an inverted position, with the ampoule brought against the inner side of the cap and the annular space between the fiber tube 11 and the ampoule 5 is filled with methacrylate fluid which is then made to polymerize.

The fracturing member may have shapes other than spherical and may be mounted with other types of safety devices, e. g., for example, with a supporting spring, not shown, having sufficient strength to resist movement of the fracturing member until adequate impact is given to the unit. For example, the spring may be placed under suitable compression between the steel ball 8 and the bottom of the recess.

The cotter pin 9 which acts as an arming device is inserted through the aperture 3 in the cap 2 and has a looped end 12 protruding above the cap. A pull ring 13 is passed through this loop. The annular space between the cotter pin 9 and the fiber tube 10 may be filled with wax or any suitable soft plastic material which permits extraction of the cotter pin 9 by pulling on the pull ring 13.

For protection in carrying, the grenade is packed in a metal container or casing 14, such as a tin can, with a corrugated paper liner 15. A tab 16 of strong tape is provided to permit easy withdrawal of the grenade and also to cover the cotter-pin pull ring 13 and thereby prevent the accidental or premature withdrawal of the cotter pin 9. The cover 17, made of tin plate, lacquered, black plate, plastic or the like, is held in place on the casing body 14 by an easily removed seal of tape 18. In the packaged condition, the grenade will stand considerable shock and can be handled readily without concern. If it is not necessarily set off by rifle fire, for when a bullet hits and shatters the glass ampoule, the igniting fluid, being surrounded by the gasoline gel, does not come into contact with air to ignite; in a short time the fluid may dissolve in

or react chemically with the gelling agent and thereby become protected from contact with air or desiccated.

Even when removed from the case, the grenade is not subject to accidental ignition. If it sustains a severe impact by dropping onto a hard surface, the outer glass jar breaks first and takes up the bulk of the impact force; and the ampoule containing the igniting fluid is thereby spared and remains intact. The ampoule 5 is further cushioned and protected by the surrounding gel 4. Thus it is only when the munition is armed by deliberate withdrawal of the cotter pin 9 that the ampoule 5 is at all likely to be fractured. When the arming operation is performed, the fall of the steel ball 8 into the recess is not sufficient to break the glass; but the ball is then loose in the recess compartment and will break the ampoule 5 when the grenade is impacted on a target.

The ampoule 5 is constructed of a frangible material sufficiently strong to resist fracturing until the predetermined minimum impact force is received by the grenade. In general, the ampoule 5 may have thinner walls and less strength than the outer frangible jar container. For example, the glass wall of the outer jar container 1 may be from about ¼ to ½ inch thick, whereas the wall thickness of the ampoule 5 may be from about ⅛ to ¼ inch.

A preferred type of incendiary fuel is a gel which is stable throughout a temperature range from -40° F. to 150° F., so as to be capable of use in climates ranging from the cold regions of Alaska to the tropics. The gels should have a strong cohesion and stickiness so that when they strike a target, they will adhere and do the greatest damage. A preferred type of incendiary gel for use as a filling in the grenade is described in a copending application, Serial No. 508,832, filed November 1, 1943. This type of gel comprises a mixture of aluminum soaps of saturated fatty acids and aluminum soaps of naphthenic and/or unsaturated fatty acids. In addition to the soaps, the gelled gasoline may contain other substances such as lamp black or wood flour. Other gelled, thickened or solidified fuels may also be used, such as mixtures of combustible oils with rubber or with synthetic high molecular weight linear polymers, e. g., methylmethacrylate, polystyrene and the like. The thickened, gelled or solidified fuel filling may be modified to accelerate its ignition, particularly when it is to be used in a grenade at extremely low temperatures. To accomplish this modification, additives of certain low fire point substances may be used, e. g., ultraviolet absorbers, peroxides, polyamides, free sulfur, and aliphatic ethers. Such additives need not be too volatile and may be safely mixed with the fuel.

The grenade will withstand hydrolytic immersion in water or exposure to the most severe conditions of high humidity. It functions fully satisfactorily at all operational temperatures, even over the range from -40° F. to 100° F. The igniter, being sealed in glass, is subject to no deterioration whatsoever under any conditions or time of storage. The complete unit can be shipped with little danger. An alternate scheme which provides still greater security is to ship the unit without gasoline but with the proper amount of Knapalm or other soft thickening agent in the glass jar. Just before use, the cap may be unscrewed and the jar filled with gasoline. Then the cap may be put in place and the unit shaken

and given a few minutes to allow for relation.

The grenade has many tactical uses. When thrown against a wall or other hard surface, the grenade forms a wide splatter of flaming sticks 45° which adheres to the target and works a very efficient incendiary effect. Thus the unit is well adapted for use in demolishing factory buildings, warehouses or dwellings. It is also a very effective anti-tank weapon. A hit somewhere near either the turret or the air intake of a hostile tank can be very destructive. The gel will adhere to the metal surface and will continue to burn for several minutes. The flames can thus be drawn into the tank with resulting attrition of the crew, stoppage of the motor or combustion of lubricating oil in the revolving turret. The grenade is conveniently set for action since it can be promptly armed and can be of convenient size for throwing by hand. At the instant the grenade strikes the target, its incendiary action is begun, and the incendiary fuel remains on the target.

It is to be understood that although the invention has been described with reference to specific preferred embodiments, other modifications come within the spirit and scope thereof.

What is claimed is:

1. An incendiary grenade comprising in a fragile container a carbonaceous fuel, a hermetically sealed glass bulb charged with an igniting fluid which remains liquid at temperatures as low as about -40° F. and which bursts into flame on exposure to air, a ball wholly within said container and intermediate of said bulb and said container for fracturing said glass bulb on adequate impact of the grenade, when resistance to movement of the body is removed, and a flexible bifurcated metal means for holding said ball and preventing said ball from breaking said bulb until the grenade is deliberately armed and receives an adequate impact.

2. An incendiary device adapted for instantaneous ignition upon impact with adequate force, comprising a glass container filled with a sticky gelled gasoline, a separate hermetically sealed glass ampoule having a re-entrant portion charged with an igniting fluid which is spontaneously inflammable in air, said ampoule being substantially immersed in the gelled gasoline, a metallic bifurcated supporting means secured to said container and extending into said re-entrant

portion, and a glass-fracturing body detachably mounted in said re-entrant portion on said supporting means wholly within said container and secured with relation to the ampoule in a safe position to avoid fracturing the ampoule until said body is released into an armed position and the grenade receives a predetermined adequate impact.

3. An incendiary grenade comprising a glass jar, a screw cap cover for the jar, said screw cap covering having an aperture, a cotter pin fastener having a looped end protruding above the cover and projecting through the aperture of the cover into the jar, a steel fracturing member detachably secured to said fastener, a glass ampoule having a flower bulb form, said ampoule hermetically inclosing a liquid organo-metallic incendiary compound which ignites spontaneously in air, a plastic seal attaching said ampoule to the cover with the ampoule providing a recess space for inclosing said steel fracturing member, a bent end of the cotter pin, and a pull ring passed through the looped end of the cotter pin above the cover for manipulation in arming the grenade by removal of the cotter pin.

LOUIS F. FISHER
GEORGE C. HARRIS
EMANUEL B. HESBERG
MORLEY MOROJANA
FREDERICK C. NOVELLO
STEARNS T. PUTNAM

REFERENCES CITED

The following references are of record to the file of this patent:

UNITED STATES PATENTS

Number	Name	Date
1,204,150	Orin	Feb. 11, 1919
1,484,100	Ray	Feb. 19, 1924
1,558,455	Mills	May 17, 1929
2,445,911	Cock et al.	July 30, 1948

FOREIGN PATENTS

Number	Country	Date
127,050	Great Britain	May 20, 1910
100,398	Great Britain	Aug. 7, 1914
328,155	Great Britain	Oct. 23, 1930
542,324	Great Britain	Mar. 2, 1942
543,038	Great Britain	May 7, 1942

RHODESIAN KNOCK-KNOCK

This little beauty was developed by the Rhodesian SAS for use on their surprise visits to ZANLA and ZIPRA cadres in Mozambique. It is a self-adhesive, linear-shaped charge that will cut through hinges and door locks quickly and cleanly.

Construction of the device is simplicity in itself. Cut a 4-inch-long piece of 1/2-inch-diameter copper pipe lengthwise into two pieces. Glue one of the pipe halves to a sheet of plastic 1 inch wide by 4 inches long. When it is dry, cut a strip of sheet explosive about 3/4 inch wide by 4 inches long. Remove the adhesive cover from the back and fix it to the copper pipe as shown. Place a strip of padded, double-sided adhesive tape on the bottom of the plastic strip, using one of its adhesive faces. That's all there is to it. Prime as normal for sheet explosive.

The example shown in the illustration uses the sheet explosive priming clip that usually comes in the package, but how you prime it is up to you. A three-second pyrotechnic delay was used on the original. If sheet explosive is unavailable, there is a version that uses conventional plastic explosive. To use, remove the adhesive backing from the tape and slap it over the lock or hinge. Boom, door open.

END VIEW

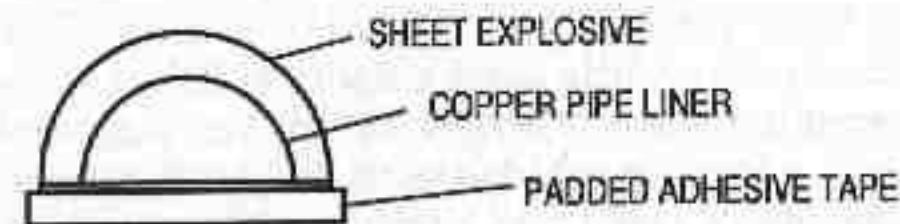

Rhodesian knock-knock.

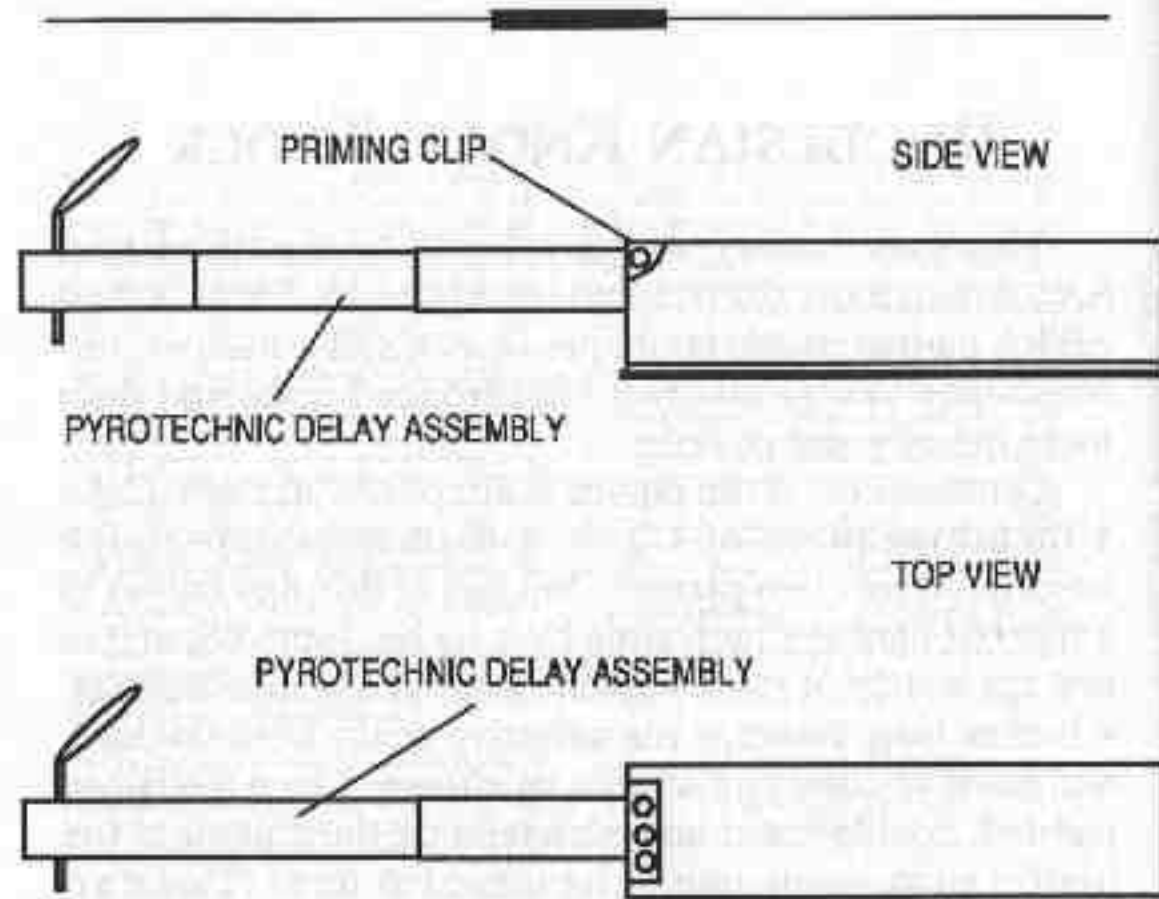

Rhodesian knock-knock.

AMMONPULVER (AP)

AP was developed in the late 1880s as a replacement for black powder. It is an intimate mixture of 85 percent ammonium nitrate and 15 percent charcoal. It was used by Germany and Austria as an artillery propellant until nitrocellulose-based powders became commonly available. It was extremely powerful, being on a par with double-based powders containing 30 percent nitroglycerine, and was virtually smokeless and flashless.

Unfortunately, AP had two drawbacks that made it undesirable as a propellant. First, since it was based on AN it was extremely hygroscopic, and second, when it was heated to moderate temperatures (32.1°C), a change in the crystalline structure occurred, causing the powder grains to crumble. This would cause a drastic increase in the chamber pressure of guns using this propellant, often causing burst tubes.

Since we will be using AP as a bomb filler, however, this becomes a positive asset. It is very cheap to make—about thirty to forty cents a pound—and is quite insensitive to shock and friction. It is, however, much harder to ignite than black powder, so a booster consisting of a few grams of a more sensitive compound such as potassium chlorate/sugar or black powder must be used. As a filler for pipe bombs or related items it is without peer.

PREPARATION:

1) Grind the AN prills in a blender until finely powdered. Sift through a flour sifter, spread out in a shallow pan, and dry for fifteen to twenty minutes in a warm oven. Pour into an airtight jar and seal.

2) Pulverize the charcoal in a heavy cloth bag, then grind in the blender. Sift.

3) Pour 85 percent AN and 15 percent charcoal, by weight, into a rock or case tumbler and add a handful of

lead balls. Tumble for several hours. Open and inspect. The contents should be a fine, dark gray powder. It may be necessary to tumble for an additional length of time.

AP must be as finely powdered as sifted flour for optimum performance. The hardness of the charcoal is the major obstacle to achieving this state. I find it simpler to buy powdered charcoal (325 mesh) at a chemical supply house as opposed to powdering barbecue briquettes. This form of charcoal may also be found at companies catering to the sign-painting industry. Ask for "pounce powder." Both the separate ingredients and the completed powder must be scrupulously protected from moisture during all operations. Any device containing AP should be painted with a sealer as a precautionary measure.

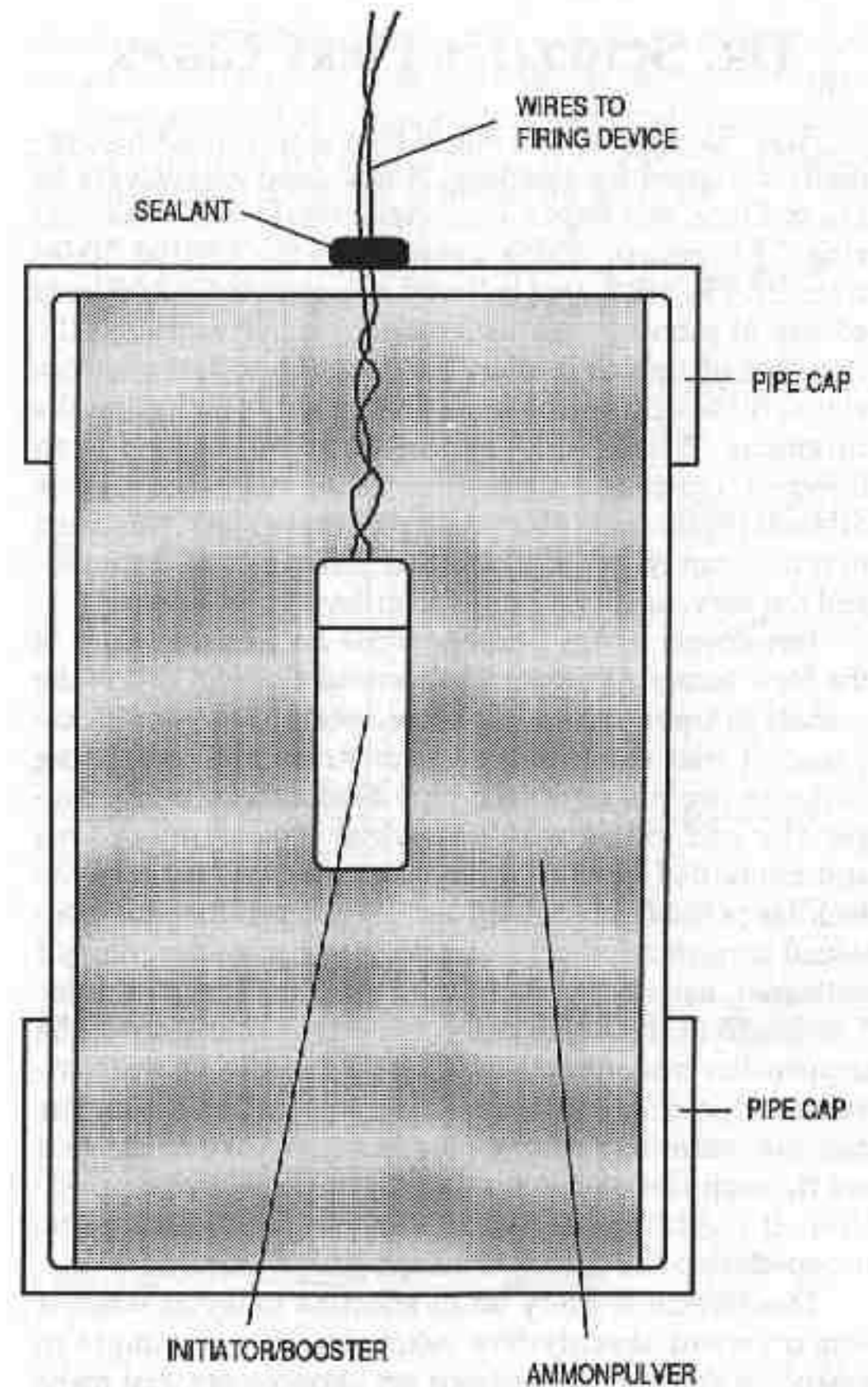

Pipe bomb using ammonpolver as a filler.

DR. SCHEELE'S FIERY CIGAR

The "fiery cigar" was one of the earliest weapons especially designed for sabotage. It was used extensively by Count Franz von Papen's notorious World War I sabotage ring. This group, which operated in the United States from 1915 to 1917, was believed responsible for hundreds of acts of sabotage against companies that supplied the French and British armies. They set fire to innumerable ships, blew up several munitions plants (including the infamous "Black Tom" explosion of 1916), and even infected livestock destined for Allied use with various disease organisms. The quality of their work was such that they rarely left any clue that sabotage had occurred, and the fiery cigar was one of their favorite weapons.

Developed by Dr. Scheele while he was president of the New Jersey Agricultural Chemical Company, it is the archetype upon which all other incendiary pencils are based. It was very simple to construct and use, being basically two pieces of lead pipe sandwiching a thin copper disc and joined with a standard pipe coupling. One end contained an incendiary composition, such as the familiar potassium chlorate and sugar, and the other contained concentrated sulfuric acid. The ends were plugged with wax, usually in the form of sawed off candle stubs. The length of the delay depended on the thickness of the copper disc and, of course, the temperature. It was activated by pouring the required amount of acid into the end and jamming the wax plug in tightly. When the acid ate through the disc it ignited the incendiary composition. It could be armed on site or in advance to be dropped from the pocket at an opportune moment.

This device is every bit as effective today as when it was invented seventy-five years ago. It is so simple to make that detailed instructions are unnecessary. Just make sure that the pipe nipples are screwed up tight to the disc.

As an added safety precaution, you may want to seal around the edges of the disc with wax to prevent leakage.

Also pictured is a later version believed to have been used by German saboteurs during World War II. It used a thumbscrew to break the acid vial on arming.

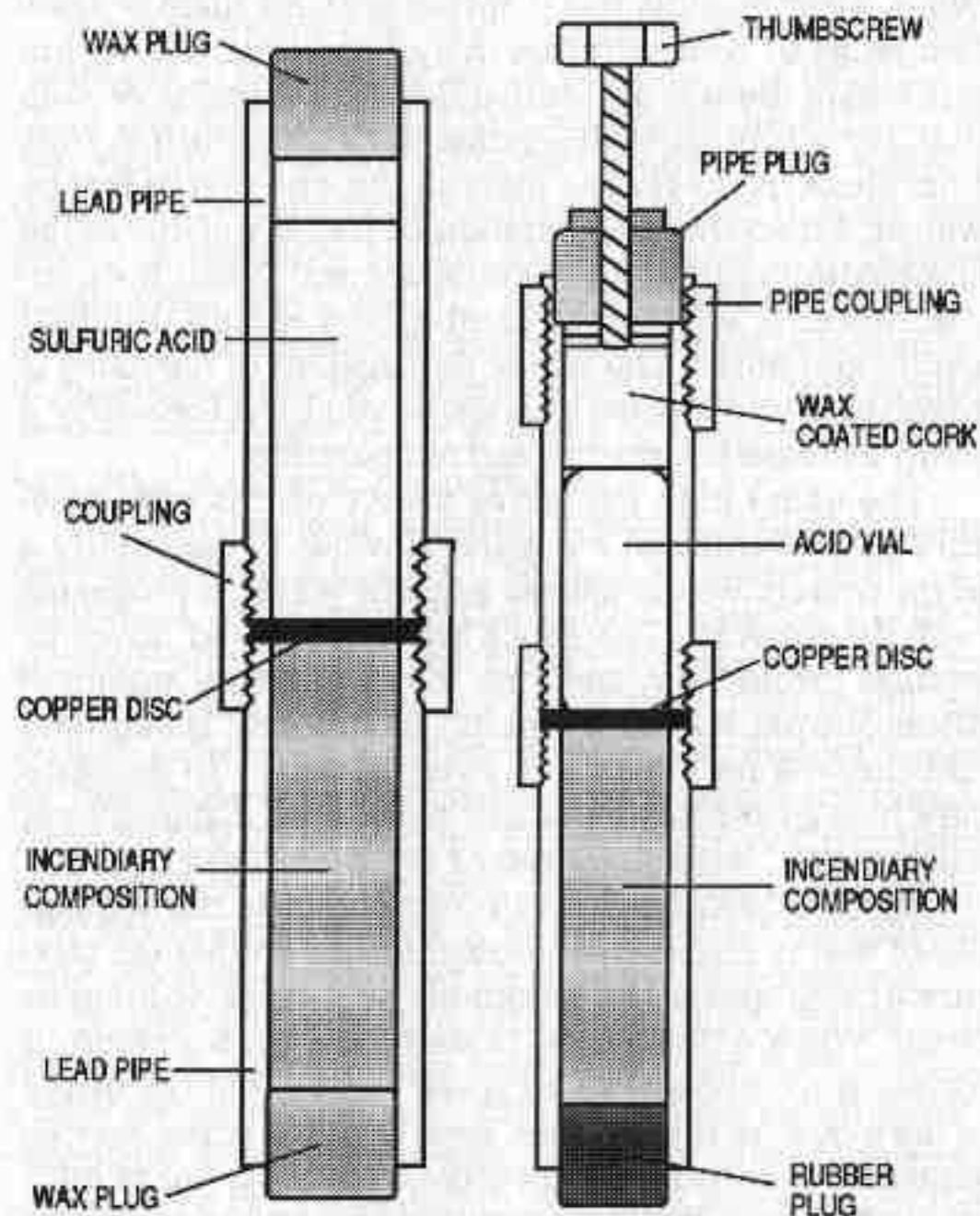

Dr. Scheele's fiery cigar (left). Later version of the fiery cigar (right).

MOTHBALL BOMB

The mothball bomb is a somewhat facetious name for what is in reality one of the most advanced forms of pure fuel-air explosive in existence, the implosion FAE. When a combustible fuel is mixed with air there is a certain range of concentration that is combustible. Within this region there is a so-called detonation region or ratio that, for a typical hydrocarbon such as gasoline, runs from about ten to sixteen parts air per one part of fuel by weight. When the concentration of fuel is outside of the combustion region, no burning occurs. When the concentration is within the combustion region, the fuel ignites and burns. The rate of propagation of the flame is supersonic and creates a shock wave characterized by a sharp increase in pressure and temperature.

The usual high explosive source of this over-pressure in conventional explosive devices is essentially a point source, which causes a shock wave to propagate radially outward. The shock wave is slowed down by passage through air, and after it has passed a sufficient distance from its starting point, its velocity is subsonic and there is no longer any over-pressure. To generate very high over-pressure at any substantial distance from a detonation, large quantities of explosive must be used.

The FAE weapon differs substantially in that a quantity of fuel is distributed through the air so that the mixture of fuel and air is detonable in a large volume or cloud. When a detonation is started in such a cloud, it travels at a constant rate of speed throughout the extent of the cloud. In this manner, large over-pressures may be generated at substantial distances from the point of initiation. Although the maximum over-pressures are not as great as are obtained with conventional high explosives, the large levels are generated over wide areas and cause more damage than is possible with the same weight of

high explosive. One of the problems with previous devices was the timing of the initiation of the cloud of fuel when at its optimum concentration for detonation. With liquid and gaseous fuels the amount of time it takes for this to occur varies widely with differences in altitude, temperature, and type of fuel.

The implosion FAE will function at optimum power, regardless of these variables. In addition, it is remarkably cheap and easy to build. The exact size or dimensions are not critical; nor, really, is the fuel. Many widely different types of fuel will perform serviceably in it. This was proven in testing by the fact that powdered polyethylene plastic rated very closely in power to the best fuel available—naphthalene moth crystals. Polyethylene is nontoxic, nonexplosive, and basically inert. Until it is imploded under these conditions, it is about as dangerous as sand. In an implosion FAE it is devastating.

The device itself is a simple plastic cylinder about twice as high as it is wide. The ends are closed with 1/2-inch-thick aluminum discs. In the center is a brittle glass or plastic tube containing the igniter mix. The igniter initiates combustion at the same time the cloud is disseminated by sending out high-temperature metallic fragments equally dispersed throughout the cloud. When the cloud reaches the proper air/fuel ratio to detonate, there will be ignition particles there to light it. That is why this device is so effective—it decides for itself when the conditions are optimal for detonation.

Wrapped around the exterior of the cylinder is a continuous layer of sheet explosive. Four electric detonators are placed every 90 degrees and are set off simultaneously. Upon detonation, a substantially cylindrical shock wave is propagated through the fuel towards the center of the device. The high-velocity shock wave ejects the fuel radially outward, and the aluminum end plates reflect the shock wave so that very little of the fuel is ejected vertically.

A device of this type was tested several years ago containing thirty-seven gallons of pentane (an industrial solvent) and surrounded by a layer of explosive 3/8 inch thick. Details of this test are as follows:

"For the first 2 to 3 milliseconds after firing, the principal effect noticed was that of the outwardly traveling shock wave from the high explosive surrounding the fuel. By about 6 milliseconds after initiation, however, the fuel had spread to a cloud diameter of about 60 feet, which represents a velocity of the forefront of the fuel cloud of about 5,000 ft/sec. At about ten milliseconds after initiation, the fuel cloud was over 88 feet in diameter and a relatively small amount of burning was observed, and what burning was occurring was largely obscured by the unburned fuel surrounding the implosion fireball. Shortly thereafter the cloud of expanding fuel reached a detonable mixture, and the flame front rapidly propagated across the entire cloud volume. At 150 milliseconds after initiation of implosion, a large fireball at extremely high temperature spread across the ground over approximately a 100-foot circle. The fireball continued to hug the ground for a time of about 1/3 second to provide considerable flash burning on a target and then commenced to rise from the ground. A substantial blast effect was obtained, and substantial burning in the fuel cloud was still occurring after a full second. A vehicle located about 30 feet from the point of initiation of the FAE was overturned and continued to burn for a substantial period of time after the dissipation of the fireball."

It is a little-known fact that FAEs create the blast and flash equivalent of nuclear weapons within the volume of their cloud. The implosion FAE provides greater destructive capability than previously known weapons, whether they are measured on the basis of effectiveness per unit of weight or unit cost of the explosive device. Let's examine the three main parts of the implosion FAE—igniter, fuel, and explosive—in more detail.

IGNITER

The igniter is a brittle glass or plastic tube containing an intimate mixture of copper oxide and aluminum powder. Interspersed within these powders are about 10 percent by volume of glass or plastic microspheres and about 10 percent by volume of puffed rice. These provide void spaces to promote reaction of the two metals and also ensure that there are many different fragment sizes and weights. This is so there will be ignition particles spread throughout the cloud when the time for detonation arrives. These particles are compressed and heated by the shock wave and actually become white hot. The ends of the tube must be plugged or capped to keep the fuel out. If desired, the igniter mix may be pressed into pellets for ease of handling and to provide the void spaces for initiation. Thermite is an acceptable substitute if available.

FUEL

The best type of fuel is one having a heat of combustion of at least 750,000 BTUs (British Thermal Units) per cubic foot. Certain fuels (i.e., the liquid hydrocarbons such as gasoline, benzene, pentane, etc.) are especially desirable since they allow the device to be field-loaded easily. Other types of fuels are good because they are not normally detonable. The previously mentioned naphthalene crystals have a heat of combustion of about 1,200,000 BTUs and are safe to handle in their solid form. The mothball bomb will function with just about anything that burns, ranging from such things as vegetable oil to starches and sugars to fuel oils, alcohol, or ammonia (see list). However, your best performance comes from a fuel having the aforementioned heat of combustion.

EXPLOSIVE

The normal explosive thickness is 1/4 inch, which is

the thickness of most sheet explosives (3/8 inch was recommended primarily, I believe, due to the military custom of using more than is needed to be on the safe side. Tests showed only a 5-percent increase in cloud performance for 3/8 inch as opposed to 1/4 inch).

If sheet explosive is unavailable, you can construct the bomb body as two concentric tubes and pack or cast the explosive in the space between them. If this is done it is best to stick to an explosive thickness of at least 3/8 inch to ensure reliable detonation. Almost any explosive may be used, but your best performance comes from one with at least as much power as TNT, preferably more.

SUITABLE FUELS FOR IMPLOSIVE FAE DEVICES

PROPANE	OLIVE OIL
STARCHES	BUTANE
CASTOR OIL	POLYVINYL CHLORIDE
PENTANE	PEANUT OIL
EPOXY POLYMERS	HEXANE
CORN OIL	GLYCOL
ETHYLENE OXIDE	BEEF TALLOW
AMMONIA	POLYETHYLENE
LARD	PROPYLENE OXIDE
CELLULOSE (SUCH AS COTTON, SAWDUST, STRAW, AND PAPER)	POLYPROPYLENE
COTTONSEED OIL	SOYBEAN OIL
POLYSTYRENE	STYRENE
TUNG OIL	ACETYLENE
LINSEED OIL	BENZENE
GASOLINE	TOLUENE
KEROSENE	PITCH
	CHARCOAL
	PARAFFIN

JET ENGINE FUEL	XYLENE
BUNKER OIL	NAPHTHALENE
GAS OIL	METHYL ALCOHOL
LUBRICATING OIL	ETHYL ALCOHOL
PETROLEUM ETHER	DIETHYL ETHER
MINERAL SPIRITS	TETRAHYDROFURAN
ASPHALT	ACETONE
WAXES	LACQUER
FLOUR	NAPALM
GLUCOSE	NITROMETHANE
FRUCTOSE	NITROBENZENE
SUCROSE	NITROETHANE
LACTOSE	LIGHT OIL
METHYL ETHYL KETONE	CREOSOTE OIL

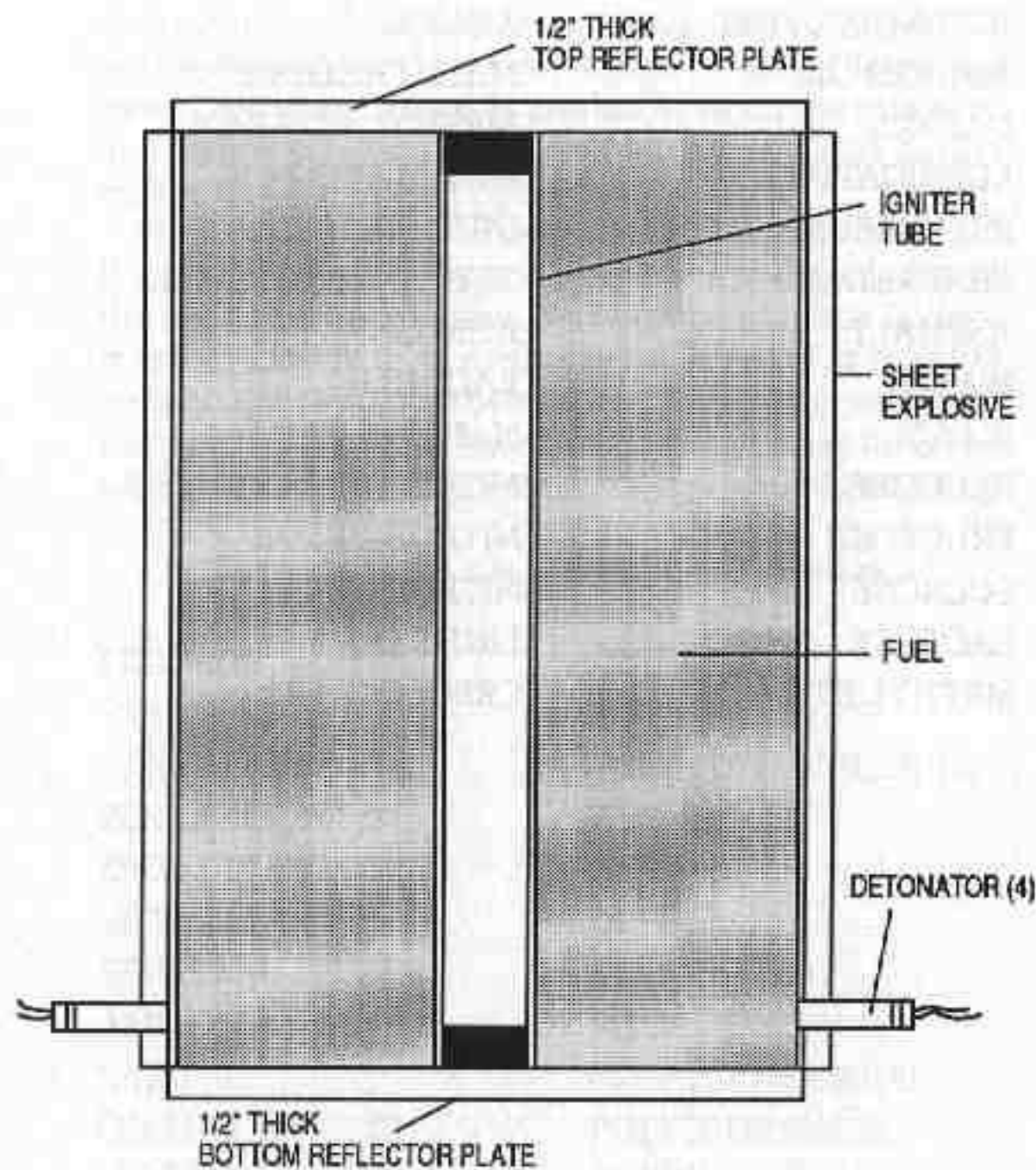

Implosive-type FAE device.

80/20 AMATOL

Amatol was developed by the British in World War I as a way of conserving their meager TNT supplies. It is composed of AN and TNT in varying ratios, the most common being 80/20. It is slightly more efficient than TNT when used in breaching charges, but since it contains AN it is somewhat hygroscopic and must be well sealed against moisture. It has a detonation velocity of 16,000 feet per second, almost twice that of straight AN. It is very insensitive, and while this makes it safe to handle (in fact, the blocks can be cut up with a hand saw), it can also make it harder to detonate.

To be on the safe side, a booster should be added. One way to accomplish this is to bore a booster well into the cast block using a 3/4-inch wood drill bit. Dissolve some of the leftover TNT in hot acetone, pour the resulting solution into a container of cold water, and stir vigorously. The TNT will precipitate out of the liquid in its crystalline form, which is the most sensitive type. These crystals are pressed into the booster cavity using heavy hand pressure, leaving a hole in which to insert the detonator. A standard No. 8 blasting cap will initiate the TNT, which in turn will detonate the amatol. If properly packaged, amatol can be stored for long periods of time with no change in sensitivity, power, or stability.

As an interesting aside, amatol was used early in World War II, but a Canadian TNT plant changed things. Though the company had never manufactured TNT before, production was unusually high. When the inspectors went to find out why, they found the normal manufacturing process had been reversed. Since this "mistake" increased output to more than three times that of any other comparably sized plant, all other TNT manufacturers adopted it. So much TNT was produced that there was no longer any need for amatol, and it was phased out.

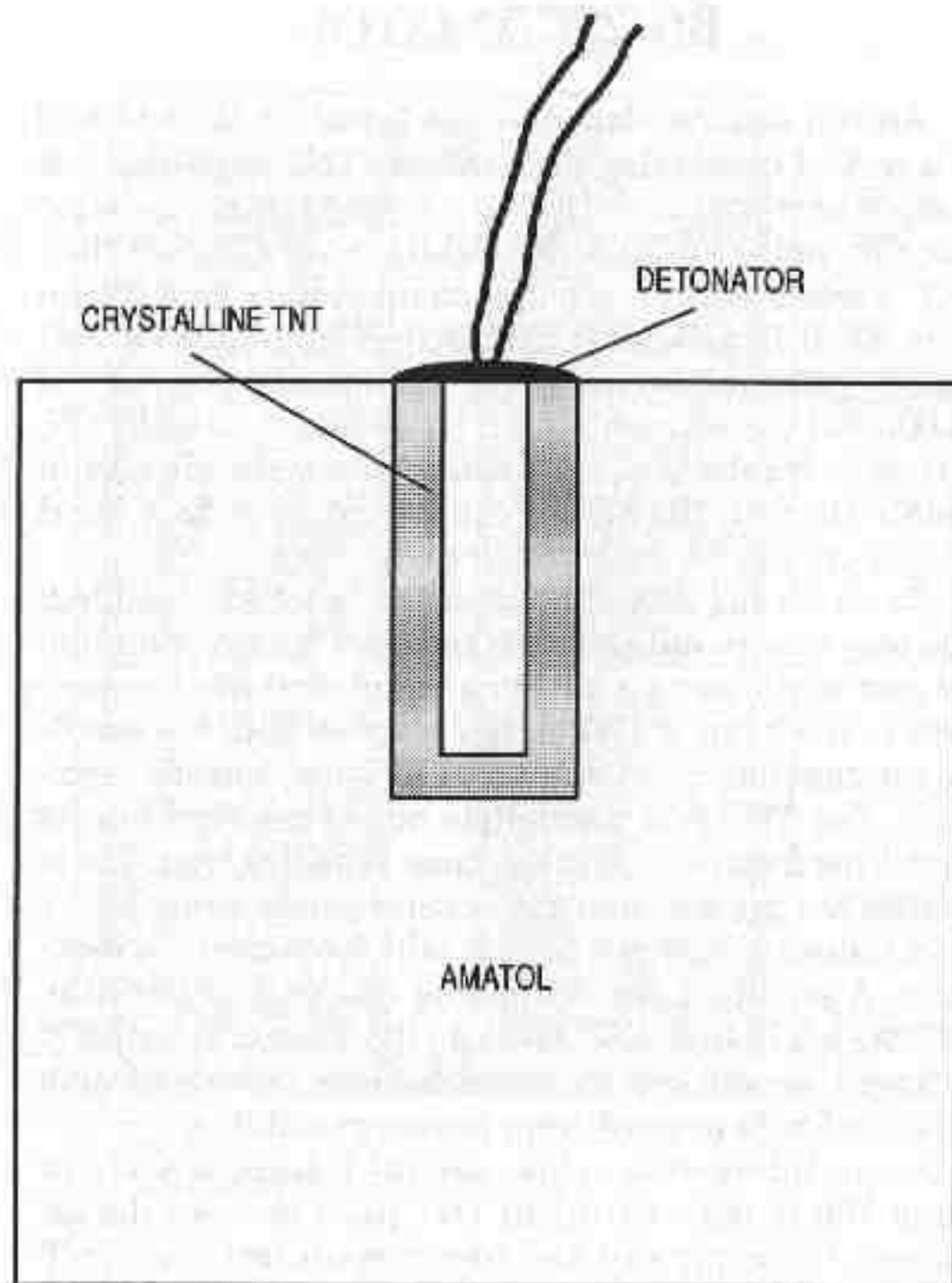

80/20 amatol demolition block.

NIPOLIT

Nipolit is a greenish-gray, soapstone-like explosive developed by the Germans in late 1944. Due to the shortage of nitrates for explosive production in the last stages of the war, Nazi scientists were working on a method of reprocessing old artillery propellant that was no longer suitable for its original purpose. Single-base propellant consists mostly of nitrocellulose, with a small percentage of various stabilizers and plasticizers added. By jelling the nitrocellulose with a solvent and blending RDX into it, they developed Nipolit.

The resulting compound had high power and very good mechanical strength. It could be cut, milled, and threaded like hard plastic. A number of different items were made from it, chiefly mines and grenades. The most interesting feature of these was that they required no external casing; the Nipolit was both waterproof and strong enough to endure rough handling. Both types of ordnance saw limited use during the invasion of Germany by Allied forces, but how much is uncertain.

At roughly the same time, Division 19 of OSS was working on a similar composition for use as explosive cloth. It contained 54.5 percent nitrocellulose, 36.4 percent PETN, and 10.1 percent plasticizer. Surprisingly, despite many positive qualities, there has been little research on these types of explosives since the war.

Nipolit can be made in different compositions, but a good one to start with is 55 percent nitrocellulose and 45 percent high explosive. The best explosives to use are RDX and PETN. Both are comparable in power and will produce excellent Nipolit, but the PETN mixture will be easier to detonate. Common smokeless powder, such as can be purchased at most gun shops, is the best source of high-quality nitrocellulose. On occasions, military surplus powder is put on the market at very attrac-

tive prices. I recently saw an ad for an 8-pound keg of slow-burning single-base powder for fifteen dollars. (Since we are only interested in nitrocellulose content, the rate of burning is of no consequence.) Once mixed with acetone, these explosives are all pretty much the same anyway.

As mentioned before, the percentages are fairly loose. This is just as well, since you'll need to experiment a little to get your ideal mixture. This is due to variances in the different types of powders. Also note that the high explosive constituent should be finely powdered for best performance.

PRODUCTION:

1) Pour the weighed amount of nitrocellulose into a ceramic mixing bowl and add about three times as much warm acetone. Let it sit for about ten minutes, then stir with a spatula. The amount of acetone required will vary with the type of powder. Add more or less as necessary. The consistency you are looking for is that of a thin jelly.

2) Gradually add the powdered high explosive while blending with a spatula. The mixture will resemble a badly made cake frosting with undissolved sugar. Do not be alarmed if the high explosive crystals are still in evidence. This is normal, depending on the type of explosive used. Just be sure that they are evenly dispersed throughout the nitrocellulose.

3) Pour the mixture into molds and press the surface to remove air bubbles. Allow the acetone to evaporate in a warm, well-ventilated area. When the mixture no longer smells of acetone, it is ready for use.

A useful piece of equipment for nipolit production is a drying cabinet. This is a simple box with wire racks like a refrigerator. Mount a heat lamp (or two) in the top with a small, slow fan next to it for circulation of the air. An exhaust vent should be placed in the bottom to get

rid of the acetone vapors. Note that acetone vapors are flammable and can be explosive.

Just about any container that is not affected by acetone can be used as molds, but the best are made with removable sides to aid rapid drying. If the mixture contains a high percentage of explosive, you can make molds of brass or copper screen. The nipolit will dry a lot quicker, but it will have a rough texture. This does not affect its explosive properties in the least, but if you find it cosmetically offensive, spray a little acetone over the surface and let it evaporate. This will smooth it right out. After the molds have dried for about an hour (this will vary), remove the mold sides, push a rod about 3 inches in to make a detonator well, and dry the rest of the way.

If desired, you can coat the outside of the completed block with a fireproof lacquer. While nipolit is strong and waterproof, it is by no stretch of the imagination fireproof. In fact, when lit with a match it makes a passable incendiary, burning much like C-3.

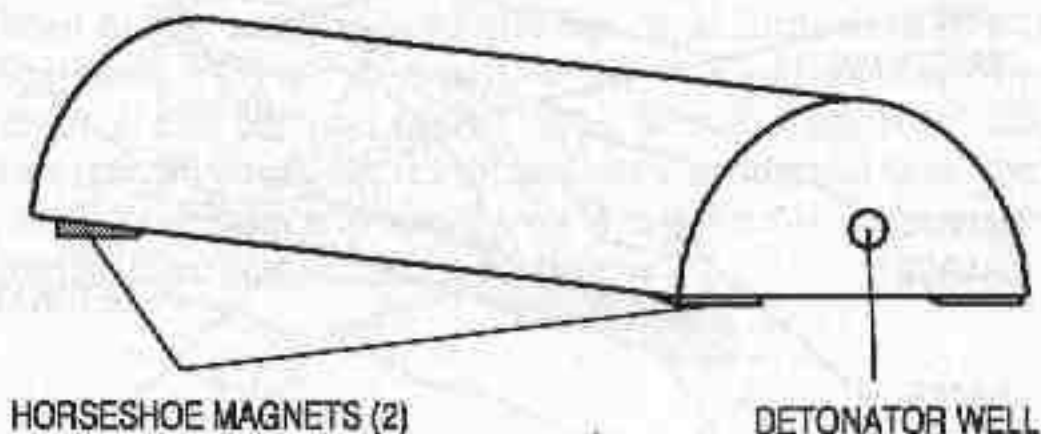

World War II magnetic mine composed of nipolit.

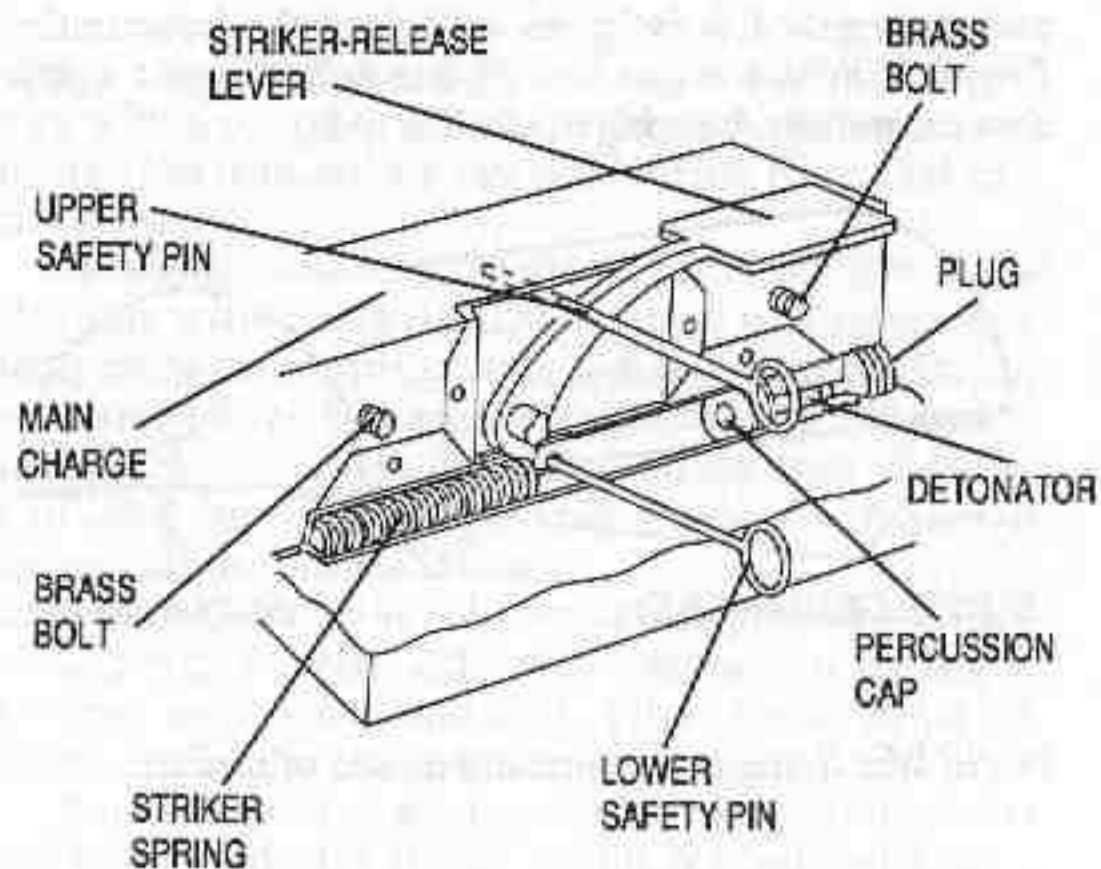
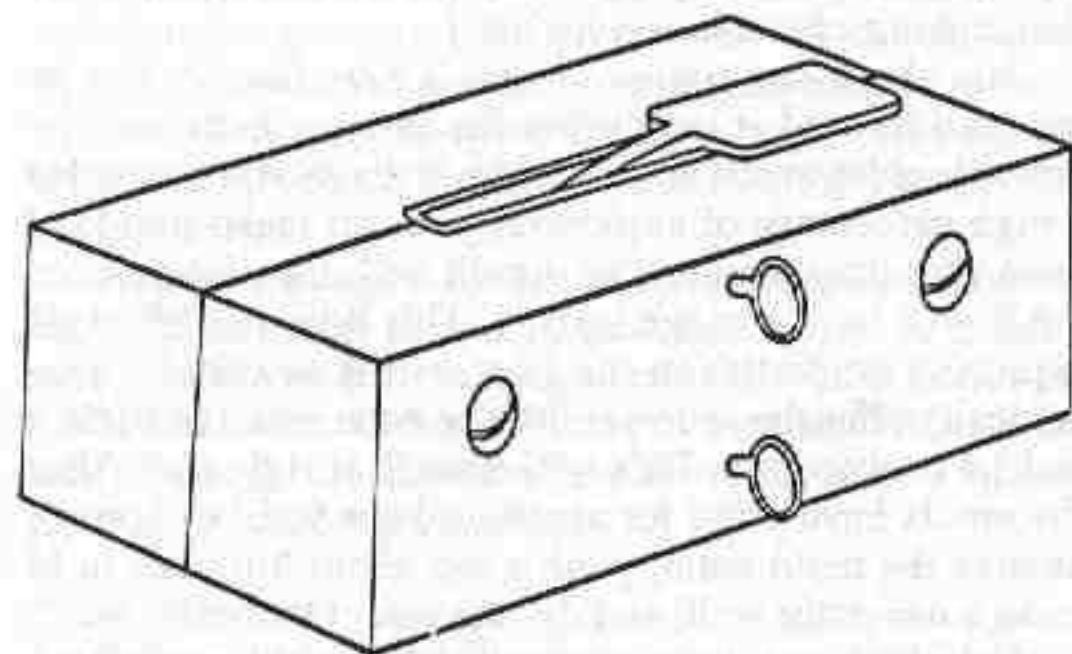

All-explosive pressure release (nipolit) device (Germany).

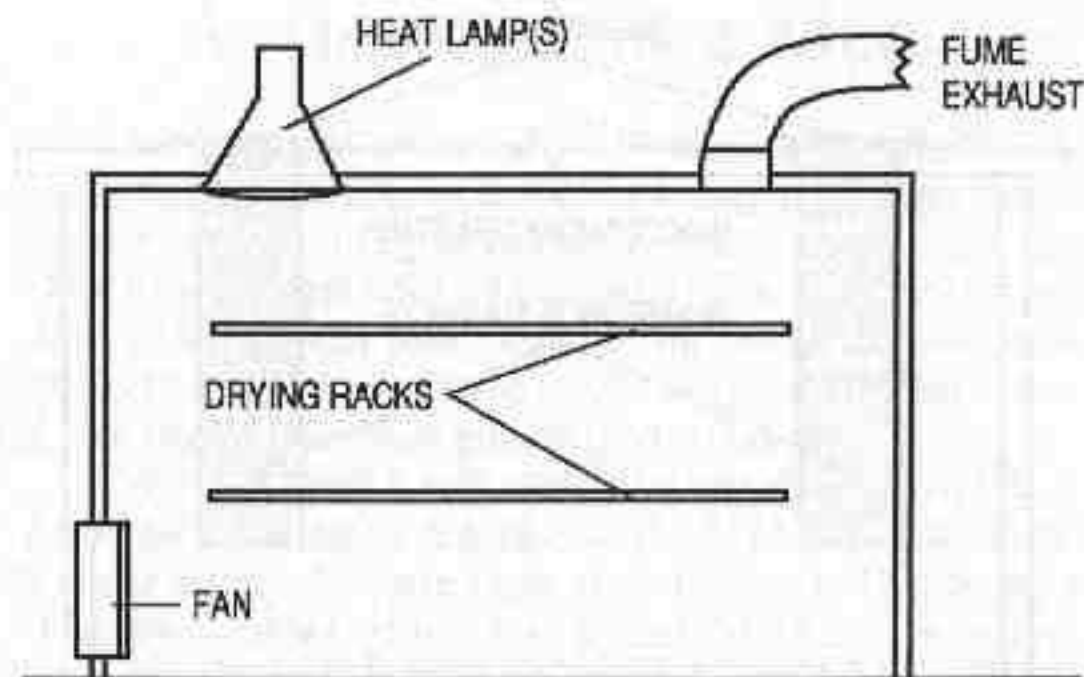

Nipolit drying cabinet.

An alternate version may be made by using a common blow dryer in place of the heat lamp and fan. It should be connected to the box by a vacuum cleaner hose at the same spot as the fan. It is important to use the hose, as blow dryers have an exposed heating filament. If the acetone fumes come into contact with this, the results could be disastrous. An industrial heat gun should be used if possible, as it can be run longer and harder than the household versions.

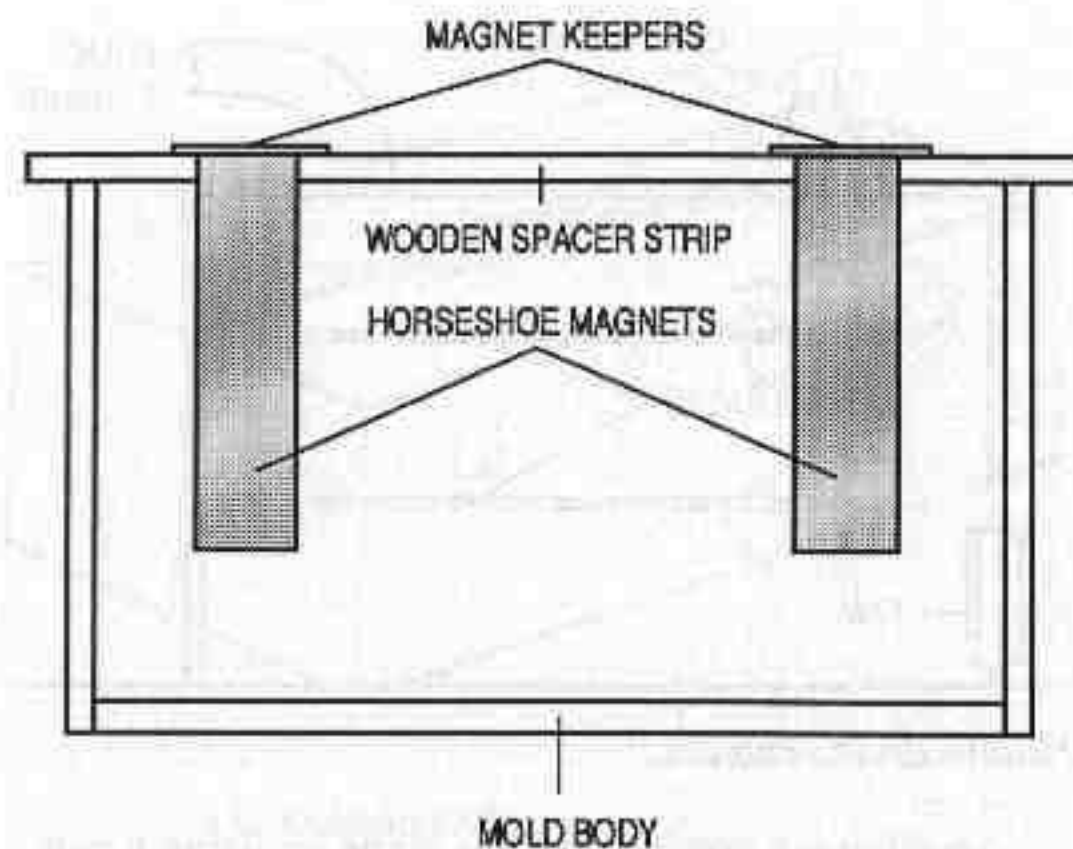

Nipolit magnetic clam hold.

The magnets are hung over a thin strip of wood to hold them a consistent 1/8-inch above the mold surface. It should be only about 3/4-inch wide to allow room for the addition of the explosive. The magnet keepers are just flat metal strips laid across the two poles of the horseshoe magnets.

ANTIDISTURBANCE MINE

This is based on an old CIA device (stock #1345-HOO-0010) that was in use before they promised not to do that sort of thing anymore. It was a small steel box (7" x 4" x 2") and held 13 ounces of C-4. The most common place it was used was in the center drawer of a desk; 13 ounces of plastic explosive going off less than a foot from your chest guaranteed a bad day.

The mine used a very sensitive vibration switch that could be adjusted to detonate at the slightest movement. This is a very delicate type of switch to build, being a thin piece of weighted leaf spring hung between two contacts. Since this type of switch is available at Radio Shack (stock #49-520), it will be used instead. The Radio Shack switch consists of a light metal box about 5 inches long by 2 inches high by 1 inch wide and uses an identical leaf-spring-type switch. There is a screw mounted on top to adjust the sensitivity. Just follow the circuit drawing for construction. You can vary its external form to suit your requirements.

A momentary switch is supplied to test the sensitivity and circuit integrity of the device. The momentary switch is depressed and the device jarred. The red lamp should flicker on. If so, release the switch. The lamp should go out. Never, under any circumstances should you plug the detonator in when the red light is on. It will detonate. If everything is okay, the detonator is plugged in and the arming switch (solder-wrapped clothespin) activated. Once the arming switch has completed the circuit, the device cannot be disarmed. If it is hidden in a desk drawer, it will detonate upon discovery.

If you need a smaller switch than the commercial variant described, you can make your own by following the drawing, using a piece of clock main spring, or you can cut down the commercial item. There is usual-

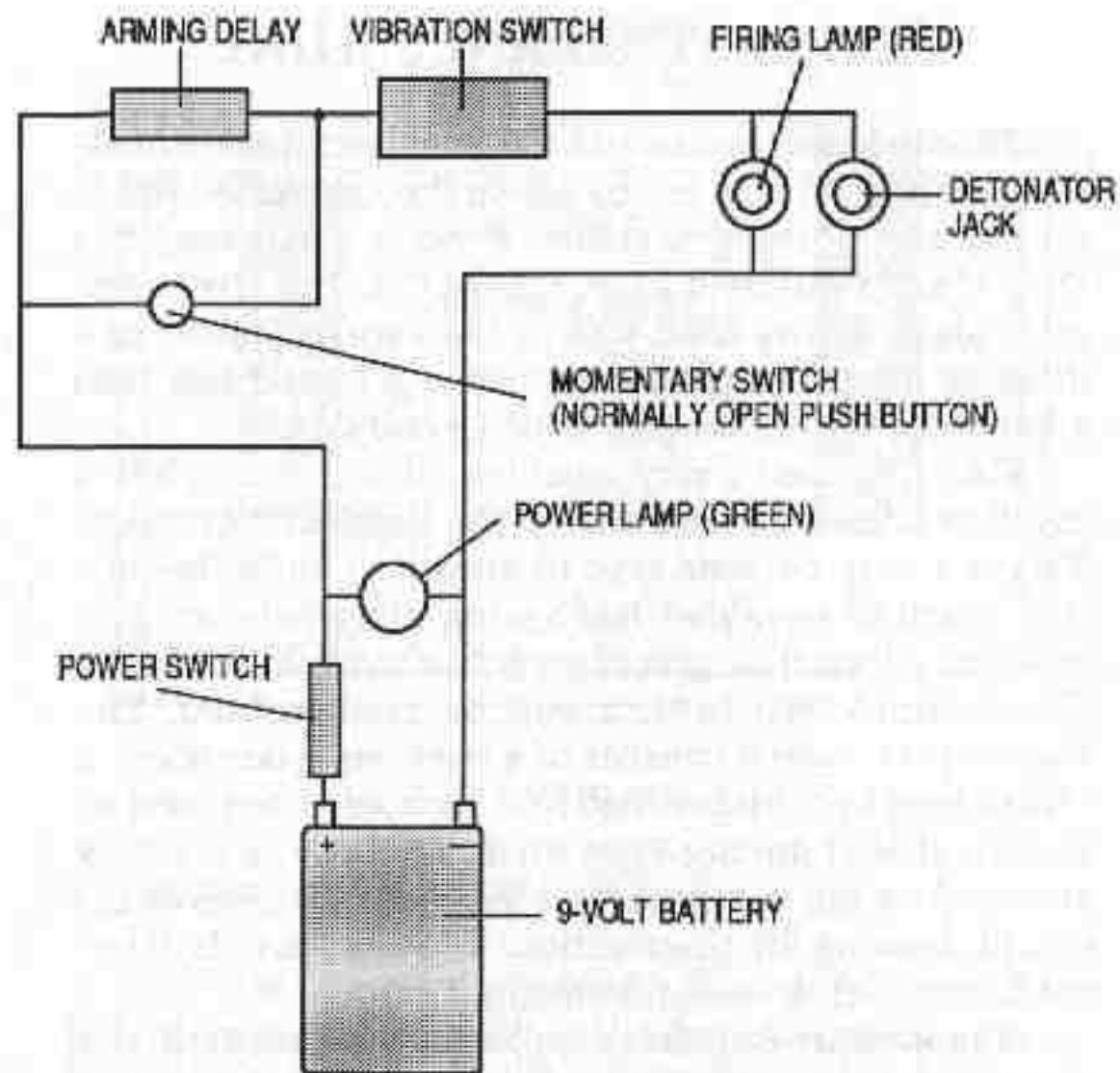

Antidisturbance mine circuit drawing.

ly a lot of excess space inside one of these, so carefully pry off the end cap and take a look. You should be able to remove at least an inch from the length.

To Use:

- 1) Place device in target area.
- 2) Flip power switch. Green lamp should light.
- 3) Depress the momentary switch. The lamp should not light unless the device is jarred. If it does, adjust the sensitivity screw about a half turn. Carefully depress the momentary switch again. The lamp should

be out until the device is jarred.

- 4) If everything checks out okay, plug in the detonator and pull the insulator from the arming switch. The device is now active. Close the drawer, or whatever, and vacate the area.

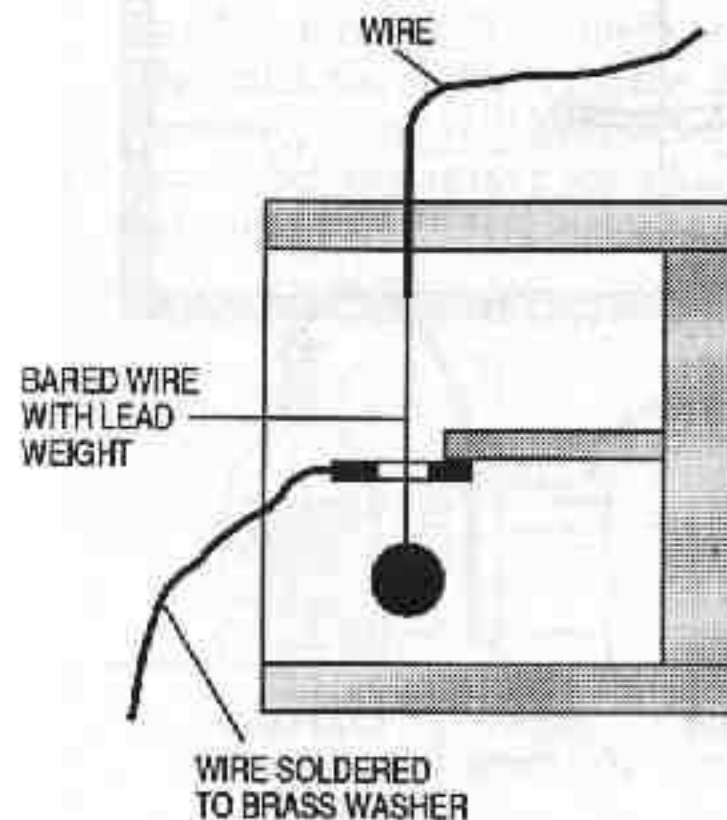
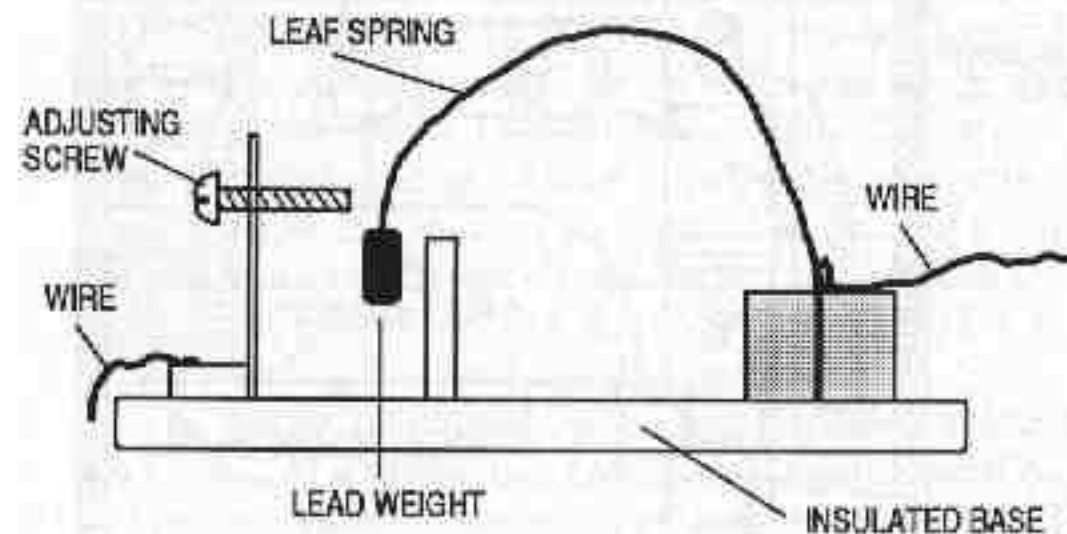

Any movement of the device causes the wire pendulum to contact the brass washer, thus completing the circuit. **WARNING:** This switch must be laid in an absolutely flat position or gravity will cause the pendulum to complete the circuit.

Antidisturbance switches. Top: leaf spring switch. Bottom: pendulum switch.

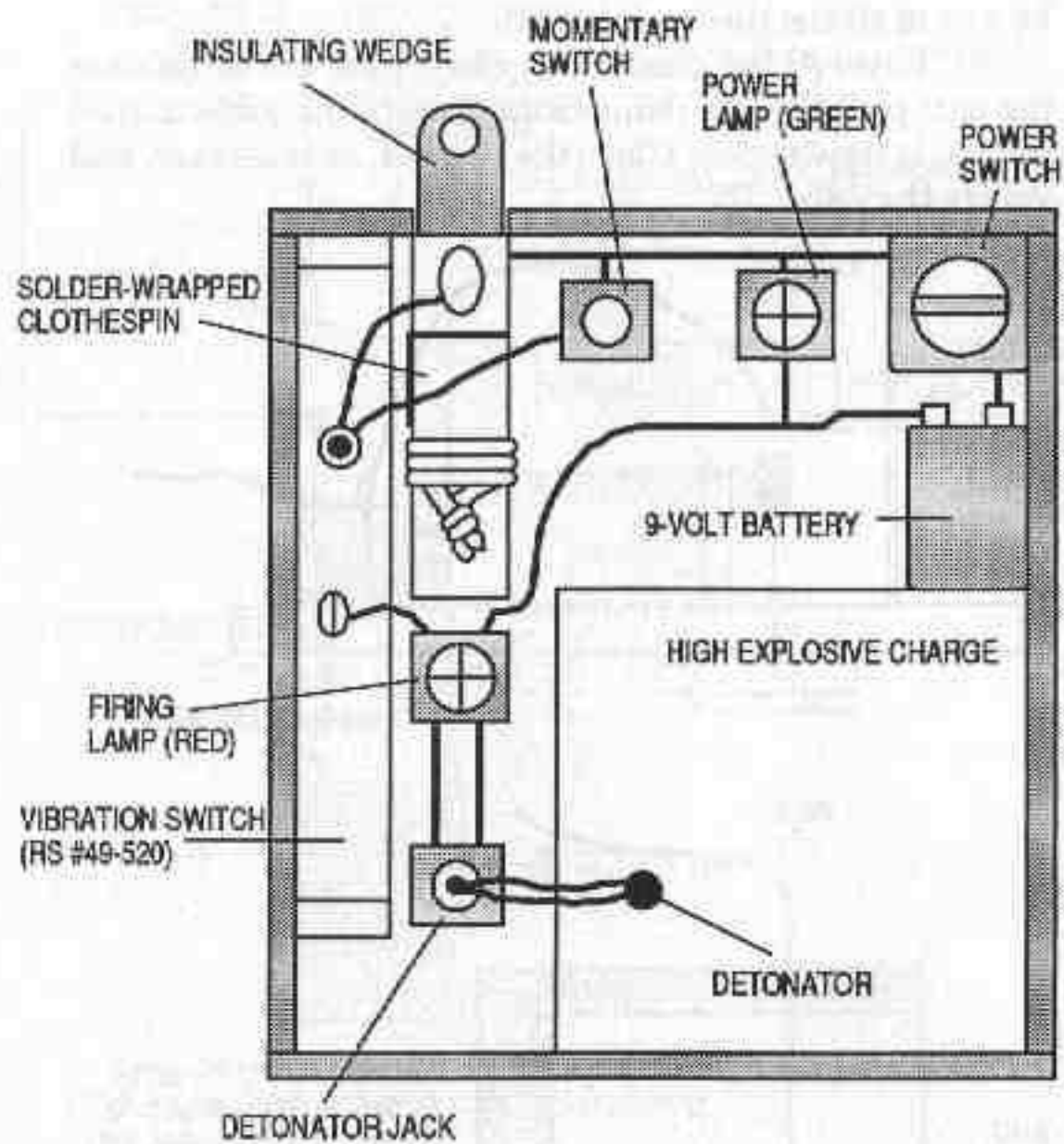

Antidisturbance mine.

FUME ABSORBER

In *Anarchist Arsenal: Improved Incendiary and Explosive Techniques* (available from Paladin Press), I covered a method of production for the high explosive RDX. The by-products of this reaction are hazardous and flammable fumes that previously had to be vented into the atmosphere. This is undesirable in an urban setting. (The presence of odd smells in inappropriate places is one of the chief ways that illicit drug laboratories are uncovered—small comfort to be arrested by the DEA as opposed to the BATF.) The use of a fume absorber will greatly reduce this problem.

The fumes produced by the reaction are vented into the bottom of a coffee can containing a glass wool pad, a layer of activated charcoal, and another glass wool pad. These items may be picked up at any pet store as aquarium filter supplies. The fumes will rise through the activated charcoal and are, for the most part, absorbed. Any remaining fumes will be taken care of by the water trap. Remember to replace the charcoal periodically and make sure the silicone sealer around the tubes is intact.

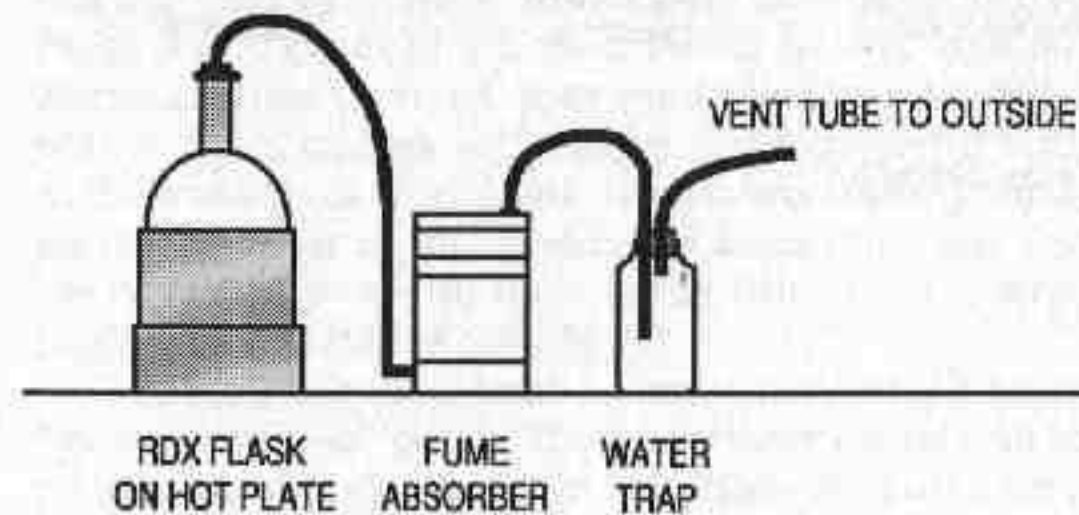

RDX production rig with fume absorber in place.

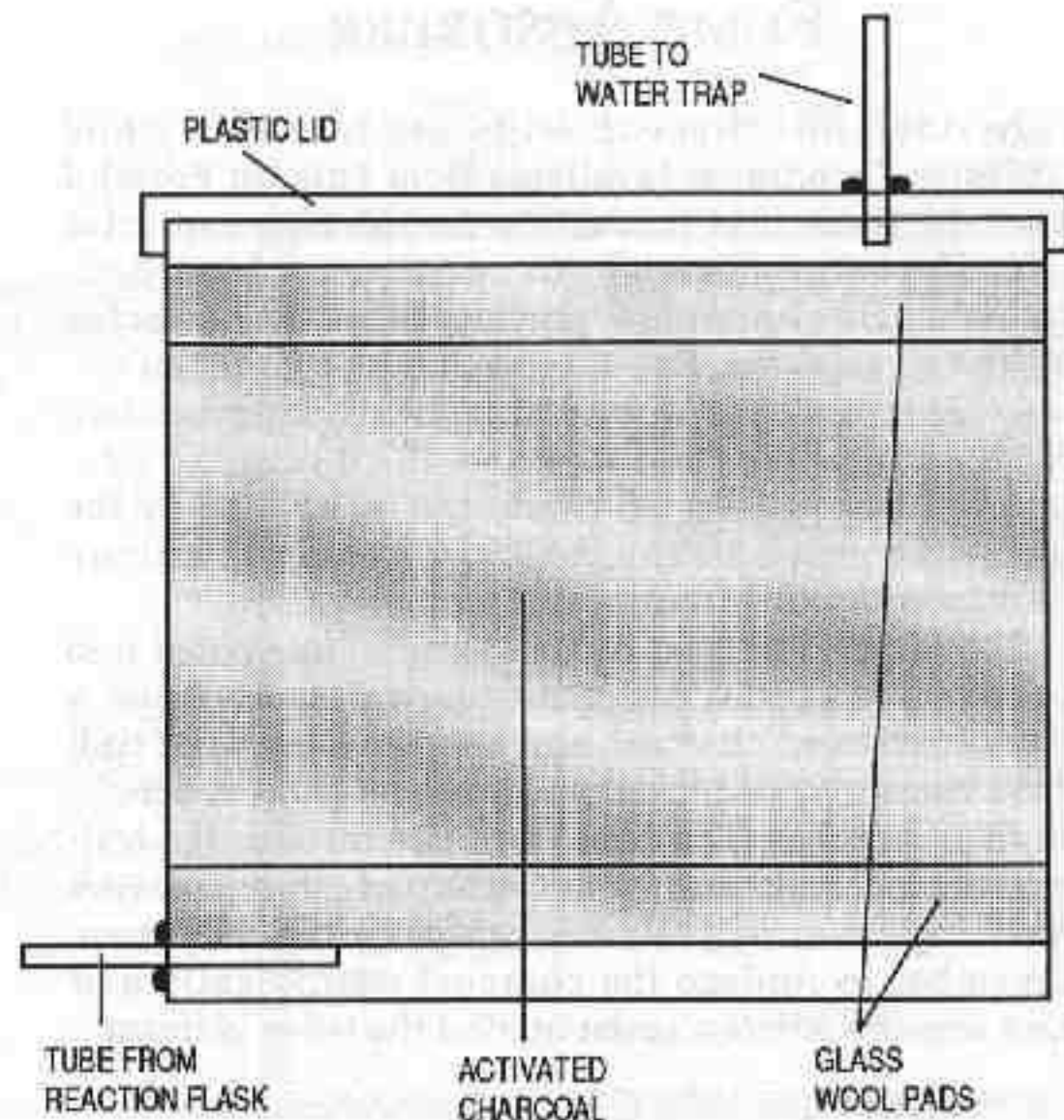

Fume absorber.

RECYCLING EXPLOSIVES

On every battlefield a certain number of all rounds fired or bombs dropped will be duds, and occasionally an underground unit will stumble upon a piece of ordnance, such as a large artillery shell or high explosive bomb. While such an item may appear to be of little use as is, the explosive it contains should be salvaged for reuse. Depending on the nature of the device, it may contain up to 55 percent of its total weight in high explosive.

Many Vietcong units operating in South Vietnam were only supplied with fuzes and detonators from the north. They were expected to scrounge up their explosives by policing the battlefield for dud rounds or bombs. The unit operating in Cu Chi (the Iron Triangle) would station observers above ground whose task it was to watch the bombs fall and note the locations of any that didn't go off. (They probably didn't get many volunteers for this job.) When a dud was located, it was dug out and opened by sawing through the bomb case with a hacksaw while cooling the cut with water.

While this in itself was not exceptionally dangerous, the fact that they were working on bombs with live fuzes was. Scores of VC were killed in this manner. Assuming they survived, they would break up the filler with wooden mallets and wedges and transport it back to their ordnance workshops. Here it was either pounded into powder or melt loaded (a hazardous job, but about the only way to remove the filler from a large bomb under primitive conditions).

The most common bomb in use is the demolition or "general purpose" bomb. These routinely contain 50 to 55 percent of their weight in HE. Place the bomb on a sturdy base and saw through the case just forward of the suspension lugs, working slowly and using plenty of coolant (Freon spray works well). Watch each stroke

carefully to make sure you only cut through the bomb case and no deeper. Tap the nose in several places with a mallet and carefully pry it loose. (Use only nonsparking tools.) If it remains attached, try squirting acetone between the case and the explosive. Let it sit for about thirty minutes and try again. Usually one or two of these treatments will break the bond between the explosive and the case (some cases are lined with a sealer before loading). Break the explosive into chunks using solid taps of the mallet and place in heavy canvas bags. Pound the bags with mallets to reduce the filler to powder. Store in sealed containers.

Artillery shells are a different matter, since they are smaller and easier to handle. These are usually primed and used with the fuze intact. The reason for this is simple. Artillery shells are carefully engineered for a maximum fragmentation pattern. In certain situations, it may be better to use, for example, a 33-pound, 105mm high-explosive projectile as a frag bomb rather than remove the explosive, which in this case weighs about 5 pounds. If you desire to remove the explosive contents, the following procedure should be used.

The shell is placed upright in a can of water, with the base resting on a coil of rope. This keeps the shell from receiving the direct heat of the fire. Wooden wedges are used to keep it stable. The water can is then heated to boiling. When the explosive has liquefied, the shell is removed and the explosive is poured into molds or charge containers and allowed to cool.

REMEMBER: Molten TNT is very shock-sensitive. It should be noted that most HE artillery shells only contain about 15 percent of their weight in explosive (see chart), and that the melting point of most high-explosive mixtures is below the boiling point of water. The three main types of high explosive used in American ordnance are TNT, Composition B (RDX/TNT), and Tritonal (TNT/aluminum powder). The last two are binary (two-

part) explosives and must be stirred before pouring to prevent the parts from separating. To make your life a little easier, the type of explosive the round or bomb contains is usually marked in large letters around the nose.

Theft and bribery directed towards munitions storage facilities are probably the best methods of acquiring these items (no fuzes to deal with). Military service is a rewarding but not highly paid line of work. You can usually find someone who needs a little extra cash (who doesn't?) and is willing to look the other way.

If you have to go the route of the VC or Soviet partisans, life will be a little tougher. Duds are about the most dangerous things in the world to deal with, even if you are a trained EOD operator. Even though specially booby-trapped fuzes are rarely used (but time delays are), there are reasons for the fuze's failure to go off. It may have been only partially armed on the way down, or a mechanical malfunction, such as a small burr, might have been present in the striker, causing it to hang up (momentarily). The sensitivity may range from one that won't go off without an act of God to one that explodes when your boot heel taps it. You never know. Frankly, even EOD operators generally prefer to "blow it in place" whenever possible.

Since this would defeat our purpose, the fuze (or fuzes—some have two) will have to be removed. Some method of remotely unscrewing it will have to be devised, and you may have to dig it out of the ground to get to the fuze. Just remember—whatever you do, do it slowly and carefully. Try to listen closely for odd sounds, especially the ones that go "click." Prepare a safe (sandbagged if possible) position about 50 yards from the bomb site and practice your 50-yard dash.

Honestly, with the wide variety of fuzes in use, I can't provide specific instructions on removing them. There is no guaranteed safe way. If your situation is such that you have to go this route, you are pretty hard

up and must accept the possibility of casualties. Just remember that it has been done in the past, and most who have approached it intelligently (and been lucky) have survived. Desperate times require desperate measures. Be sure that you take note of the fact that the booster attached to most bomb fuzes has the explosive force of a hand grenade. Treat it accordingly.

In the early 1970s, scientists working at the China Lake Naval Weapons Station in California perfected a quick and easy way of removing the plastic-bonded explosive (PBX) from obsolete missile warheads. All fuzing systems were removed, and several strands of detonating cord were placed in the center of the fuze well. The well was then filled with water and the cord was detonated. The hydraulic force of the water crushed the explosive into small chunks and powder. It was then filtered and prepared for reuse. The following is a brief excerpt from the test report.

"A MK 38 Mod 0 warhead containing 20.1 pounds of a pressed diaminotrinitro benzene (DATB) nylon explosive composition was obtained, and the aft plate and the safe and arm mechanisms were removed. Five 15-inch-long strands of 50-60 grain/ft. primacord with four extra (4-inch) strands interwoven into the center of the original five were placed in the cavity provided by removal of the safe and arm mechanism. Water was then introduced into the warhead to surround the primacord. The total explosive weight in the primacord was about 33 grams. The primacord was detonated from the aft end. All of the explosive composition was explosively shocked out of the warhead. The skin of the warhead was split open. About 60 percent of the PBX was blown out of the aft end of the warhead and captured in a container which had been placed on its side adjacent to the aft end for that purpose. About 30 percent of the explosive composition was blown out the fore end of the warhead and captured in a similar container placed adjacent to the fore end."

While no accidental detonations were reported using this technique, it should be approached with caution. Start by using one strand of det cord (waterproofed on the ends) and work your way up to five, if necessary, as the size of the cavity increases. Always make sure that the cord is centered in the well and that you have containers in place to catch the ejected explosive. Also be sure that the fuze seat liner is unscrewed and removed (see illustration).

Recommended reading: *TM 9-1325-200: Bombs and Bomb Components*, and *TM 9-1300214: Military Explosives*.

HIGH EXPLOSIVE CONTENT CHART U.S. PROJECTILES/BOMBS

PROJECTILE/BOMB	TOTAL WEIGHT	EXPLOSIVE WEIGHT
105MM GUN	33 lbs.	5 lbs.
155MM GUN	127 lbs.	20 lbs.
155MM HOWITZER	95 lbs.	5 lbs.
8-inch HOWITZER	200 lbs.	30 lbs.
BOMB, GP-100 lb.	120 lbs.	60 lbs.
BOMB, GP-250 lb.	260 lbs.	130 lbs.
BOMB, GP-500 lb.	550 lbs.	265 lbs.
BOMB, GP-1,000 lb.	1,060 lbs.	560 lbs.
BOMB, DEPTH-300 lb.	335 lbs.	240 lbs.

All weights are approximate.

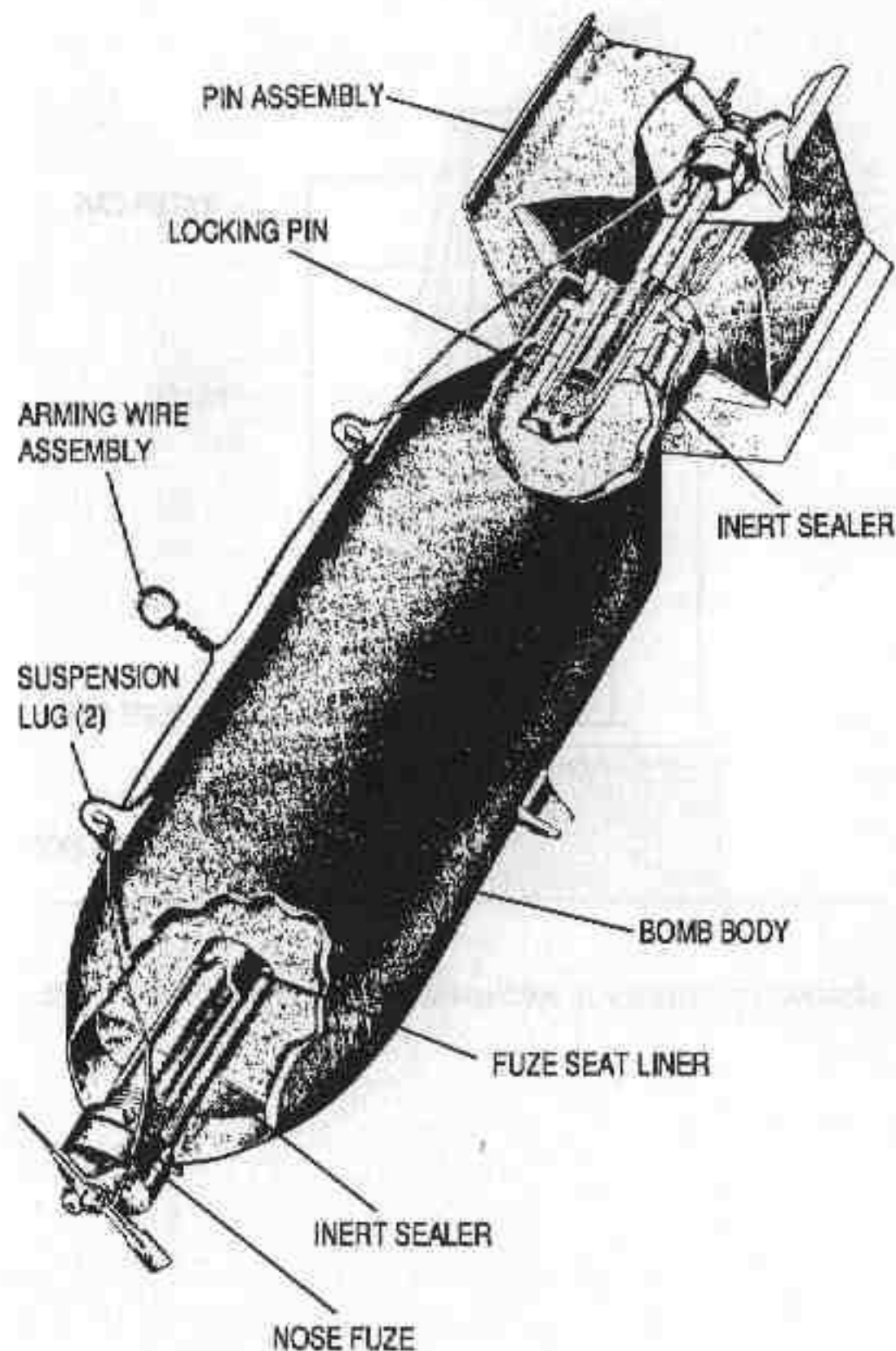
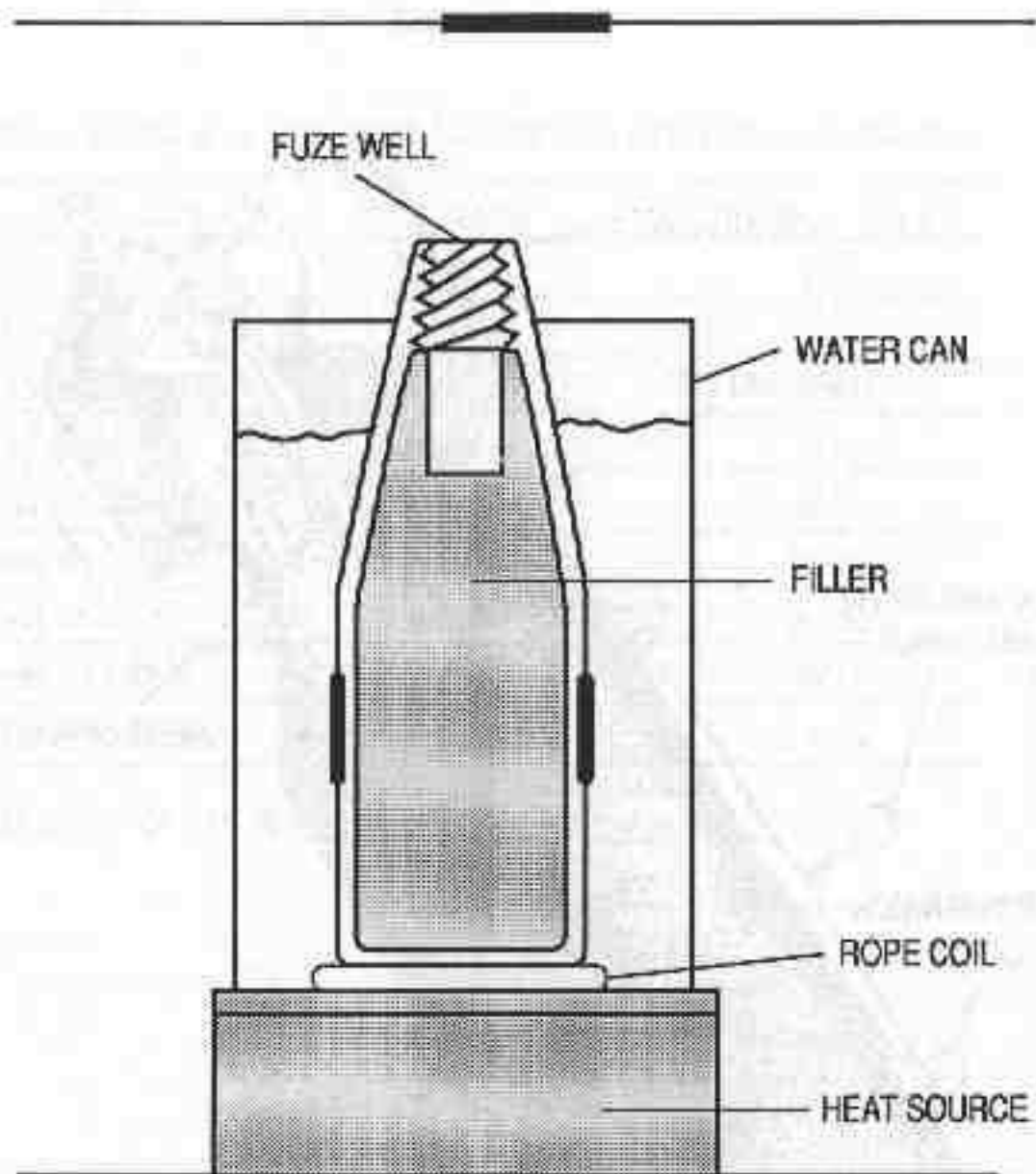

Diagram of a typical U.S. HE bomb.



Method of extracting explosive from a HE artillery shell.

Taking up where he left off with *The Anarchist Arsenal*, former military explosives specialist and avowed powder monkey David Harber returns with a bumper crop of new and unusual improvised incendiaries and explosives. In this book you'll find diagrams and step-by-step recipes for high-explosives such as gelled nitromethane, ANFO+, nipolit, and one so new it didn't even have an official name when the book went to press. You'll get the goods on exotic weapons such as the Rhodesian knock-knock and the deadly IRA truck mortar used in the recent assassination attempt on the British prime minister. You'll become well-informed in the manufacture of a fan fuze, an ERDL square charge, a baby bottle bomb, and one of the most advanced forms of fuel-air explosives in existence, the mothball bomb. Plus, you'll get in-depth information on military mining, structural demolitions, and in-the-field explosives recycling.

If the United States is to combat terrorism effectively, government officials, security providers, and concerned citizens alike must begin by arming themselves with the knowledge of the enemy. We also would do well to cultivate the skills necessary to manufacture weapons that are more innovative, more ingenious, and more effective than those of the enemy.

A PALADIN PRESS BOOK
ISBN 0-87364-634-7

