

# CAR

**How They're  
Made,  
How to Detect  
Them**

# BOMB

RECOGNITION

GUIDE

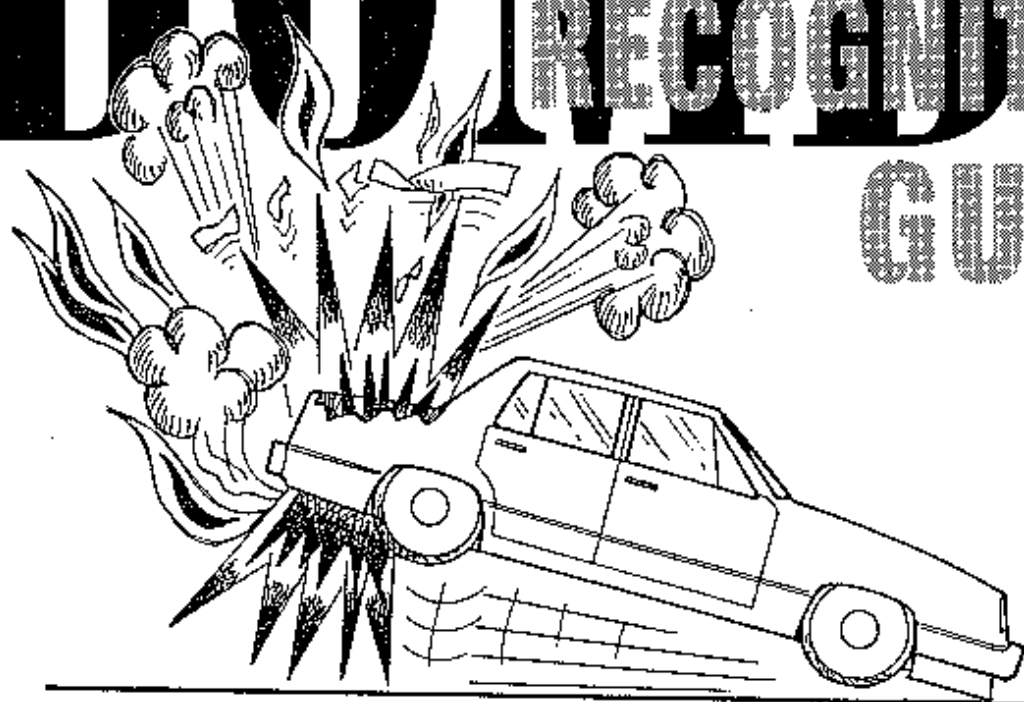

## **Contents :**

- 1- Warning .
- 2- Introduction .
- 3- Improvised Car Bombs .
- 4- Detecting and Responding to a car bomb .
  - \* UNDER THE HOOD STANDARD CAR BOMB HOOK-UP METHODS .
  - \* WEIGHTED FUSE DEVICE .
  - \* MANIFOLD FUSE IGNITION .
  - \* F/X GASOLINE MORTAR .
  - \* FLARE IGNITION DEVICE .
  - \* SHOTGUN SHELL DEVICE .
  - \* RIFLE BULLET TIMED-DELAY DEVICE .
  - \* MANHOLE DEVICE .
  - \* CHARLIE VARRICK REVISITED (TRUNK BOMB) .
  - \* THERMITE DEVICE .
  - \* GRENADE TRICKS .
  - \* FLARE GUN IGNITION .
  - \* REMOTE CONTROL BOMB .
  - \* TOY REMOTE CONTROL DEVICE .
  - \* GARAGE DOOR OPENER BOMB .
  - \* POISONOUS INSECT TRAP .
  - \* LONG-RANGE RIFLE DETONATION .
  - \* BOUNCER .
  - \* FLAMMABLE VAPOR TECHNIQUE .
  - \* AMMONIUM NITRATE TRUNK BOMB .
  - \* RADAR DETECTOR BOMB .
  - \* SPEEDOMETER DEVICES .
  - \* BLASTING CAP DEVICE .
  - \* ACCELERATOR TRIGGERING .
  - \* GIMMICKED GASOLINE CAP BOMB .
  - \* GASOLINE TANK BOMB .
  - \* FIRECRACKER IGNITION .
  - \* TOY PARTY POPPER IGNITION .
  - \* MISCELLANEOUS DEVICES AND METHODS .
  - \* HANDGUN TRAP .
  - \* SHOTGUN SHELL BOOBY TRAP .
  - \* BACKSTABBER .
  - \* HIGHWAY MIRROR DECEPTION .
  - \* HIGHWAY SPOTLIGHT DECEPTION .
  - \* REMOTE CONTROL DRIVING SYSTEM .
  - \* DEADLY AUTO INFERNO .
  - \* DEADLY CAR SEAT DEVICE .
  - \* AUTO FUSE BOX DETONATION .
  - \* INFINITY ACCELERATOR .
  - \* HYPERGOLIC FIRE STARTER .
  - \* HOMEMADE MISSILE WITH PAYLOAD .
  - \* LIGHT-SENSITIVE TRUNK BOMB 1 .
  - \* LIGHT-SENSITIVE TRUNK BOMB 2 .
  - \* LIGHT-SENSITIVE TRUNK BOMB 3 .

## Warning

This manual has been prepared for law enforcement officers, military officers, and counterterrorist specialists to assist in the recognition and identification of improvised explosive devices and booby traps emplaced in and around automobiles .

It is in no way intended to be a training manual for those with illegal intent, nor is it to be considered a substitute for professional, certified training in military and/or law enforcement explosive ordnance disposal (EOD) procedures .

Construction of improvised explosive or incendiary devices is highly illegal and extremely dangerous .The resulting end products are extremely unstable and unpredictable .Whenever dealing with explosives, special precautions must be followed in accordance with industry standards for experimentation and production.Failure to strictly follow such industry standards may result in harm to life and limb.

Therefore, the author, publisher, and distributors of this book disclaim any liability for any damages or injuries of any type that a reader or user of information contained within this book may cause or suffer from the use or misuse of said information .it is presented for academic study only .

## Read This before You Go Any Further

This manual has been prepared for police bomb technicians and concerned citizens as a recognition manual only ! Because of the possibility that this book may fall into the hands of those with criminal intent, I make this stern warning

building a bomb is a major federal crime ! New antiterrorism laws have been enacted during the Bush and Clinton administrations specifically designed to deal with persons who build and deploy bombs .

If you are caught with a bomb or even just the components necessary to build a bomb, you will be treated like a hard-core terrorist and may very well spend the rest of your life in prison .

If that doesn't deter you, then perhaps you should seriously consider the highly unstable and unpredictable nature of the devices illustrated in this book .in my opinion, anyone foolish enough to undertake the construction of a bomb deserves what he gets if it blows up in his face .

## Introduction

In order to educate and enlighten peace officers as to the construction and deployment possibilities of car bombs, I have compiled the material in this book .It has been written for one purpose :

as an educational manual for those in the law enforcement community, especially police hazardous devices technicians (aka bomb technicians) .This book is not intended to educate criminals or provide them with the knowledge or inspiration to construct an actual explosive device .

Actually, there is nothing in this book that criminals don't already know .

In order for me to write this book objectively, I wrote it strictly from an "amoral" point of view, in much the same way as the nineteenth century German philosophers wrote their great works .I chose not to take the side of good or bad or right or wrong.Through this view, pure creativity can be unleashed .

This book resulted from my complete absorption with the late John Minnery's "Auto Suggestions" in Kill Without Joy : The Complete How To Kill Book .If you have not read that book, you are really missing something .It is available from Paladin Press .it is my wish that this book take up where the ingenious Mr.Minnery's left off .

Car bombs have been with us since the gangland slayings of the 1930s, and their use is growing even today .Yet the technology has come a long way since the days of the gangsters planting six sticks of dynamite under the hood of the rival gang's car .An automobile has an electrical "nervous" system that can be tapped along many points .Only a basic knowledge of electronics is required to access it .

Also, every automobile contains a bomb built right into it : the gasoline tank .

The bomber only needs to do a bit of rewiring, drop the broken tail lamp, filament intact, into the gas tank, and, bingo, he has a bomb .When the victim turns on his lights, the filament flares up and ignites the gasoline vapors, which detonates the tank .

Terrorists have made things even more troublesome for the police bomb technician by not using any wiring in their bombs .

There is a glue that conducts electricity now on the market .The bomber need only affix the components to a board and run the glue to the components, thus creating the circuit .When the device is X-rayed, the bomb technician is unable to pick up the wiring layout .Many bomb techs don't even know this glue exists .

While we're on the subject of new terrorist tricks, here are a couple more that are of extreme importance to the police bomb technician .Booby-trapped blasting caps are the latest in the international terrorist's arsenal .Every bomb technician is advised to "attack the cap" when encountering a bomb .

Attacking the blasting cap means to cut the wire leads on the cap, thus rendering it inert .

Terrorists are now turning the tables on this technique by placing a hidden microswitch beneath or to the side of the blasting cap so that when the leads are cut and the cap is pulled out of the explosive device, the microswitch lever is released and the bomb explodes .

The microswitch is connected to a separate hidden circuit (e.g., in a hollowed-out stick of dynamite, beneath the device in a hollowed-out base, etc.) .

Another trick now favored by terrorists is the use of light-sensitive devices .The firing circuit incorporates a light-sensitive photocell .This closes the circuit when exposed to light .this type of bomb is commonly found in a briefcase, box, or automobile trunk .

Also of concern is the recent development of a product known as "X-Ray Enhancer Sheet" used by hospitals .When a sheet of this product is X- rayed, it glows .Thus when a bomber incorporates it in a light-sensitive bomb, the device cannot be X-rayed .If the police bomb technician X-rays the package to learn its contents, the enhancer sheet picks up the X-ray waves and the sheet glows .The light sensitive photocell receives the light, and the bomb explodes .

Beware of the above two products .They could drastically change the way bomb technicians disarm suspected explosive devices .

If you are a law enforcement officer, I hope you learn something new here .If you learn nothing else, just remember to keep your patrol car locked and your guard up on the home front .

## Detecting and Responding to a car bomb .

The following procedures are recommended as a general outline that may be followed in the event of a suspected car bomb .Many techniques outlined here are of the author's own invention .Note that the author is not a certified bomb technician and that the information given hereafter could potentially cause harm or death to those using the information. It is offered to certified police bomb technicians to provide possible new or improved options for dealing with car bombs .

"Prevention and awareness" is the best advice for those who think they could be the target of a car bomber .in this business, there is no such thing as being too paranoid .Simply becoming aware can have a profound effect and possibly even deter an assassin and save your life .

Always think from the criminal's point of view .if you were the bomber, how and when would you hook up the bomb ? Turn things over and over in your mind :

How would I do it ? Who are my enemies ? Where do I park my car ?

A bomb technician once told me, "Your worst enemy is almost always a friend" .And the people closest to you know your habits .

In the event a suspected car bomb is discovered, the hazardous devices technicians should be summoned at once.Normally, a uniformed officer arrives on the scene after the 911 call .He should not approach the targeted vehicle but should focus his efforts on evacuating the entire area .No one should be near doors or windows-if the device explodes, the shock wave could shatter glass for hundreds of yards, causing instant shrapnel .A rule of thumb is : if you can see anyone, he is too close .

The officer who arrives on the scene should close off the area in the safest possible manner, being careful not to get too close to the suspected car .He should summon additional manpower to close off all streets leading to the car .All police radio traffic must be done as far away as possible from the suspected car, because electric blasting caps can be detonated by radio frequency alone (the leg wires act as antenna) .

Keep in mind that the bomber may be watching the entire procedure from a nearby vantage point such as a rooftop .He may be waiting for officers to get close to the car before detonating the bomb via remote control .

Any burglar or car alarm can be used to fire a bomb simply by substituting the horn or beeper for the electric blasting cap or improvised detonator .This is why I advise you not to approach the vehicle, since such an action could fire the bomb .

Likewise, many devices could act as proximity sensors to fire a bomb .

A metal detector pointing away from the metal car could keep officers at bay .Even if the bomb technician approached it in nothing but his shorts, the metal detector could be made sensitive enough to pick up the metal fillings in his teeth .I know this sounds far-fetched, but anyone with a rudimentary knowledge of basic electronics could conceivably construct it ...and so much more .

When the police bomb technicians arrive on the scene, they should best decide how to attack the suspected vehicle .The vehicle should be viewed through high-powered binoculars or, even better, a spotter's scope or telescope .

The public should never be allowed to watch the bomb squad at work or learn the techniques employed to render a device safe .Why ? Because the bomber himself may be in the crowd watching and learning how to circumvent the render-safe procedures employed by the technicians .

Looking through the spotter's scope, the bomb technician is looking for anything out of the norm, such as visible wiring protruding through the vehicle, an open trunk, hood, door, etc .But beware : a visible bomb may only be bait for a second device triggered by other means . After the suspected car has been viewed from a distance, the decision must be made to approach the vehicle .if your department is lucky enough to have a robot equipped for this, you are at an advantage .if not, then you should consider calling a neighboring department that does .

A poor man's robot could be constructed from a toy remote-control car and a citizen's band radio equipped with a strong linear amplifier .The CB is strapped to the toy car .The car approaches the suspected vehicle and touches it .

If it does not explode, the CB mic is keyed (also via remote control) .The linear amp puts out an extremely high level of wattage .This should detonate any electric blasting cap used in the bomb .The toy car must be able to receive its signals from the bomb technician from several hundred feet away .

From this point, the car could be approached by the bomb technician .He should be in a full bomb-resistant suit and shield .This must be done with extreme caution .He should look all around the vehicle for wiring as well as underneath it .Some bomb techs use a mirror first, which is a good idea .

Always consider the possibility of simply letting the car blow up .You never see firemen rushing into a burning building unless they are positive they can win the battle .Your job is to protect human life at all costs, including your own .

Property can be replaced-people cannot .

Frequently, the news tells of a car full of explosives being placed along the road where the target habitually drives .

The bomb is detonated when the target drives by .These devices can be placed in many locations along the route and are extremely hard to detect ahead of time .

When a VIP travels through a city, security personnel arrive ahead of time to minimize these risks .This usually entails removing mailboxes, welding shut manhole covers, and towing away abandoned vehicles .

So what does the future hold ? Terrorists, many of whom employ electrical and chemical engineers, will almost certainly keep abreast of advances in microcircuitry, impossible-to-detect liquid explosives, biological and nuclear possibilities, etc .The bomb technician would be wise to keep up with these advances also .

Once again, the author makes no claims of authority nor has the proper credentials or training to give up-to-date training or information on explosive ordnance recognition or disposal .The information in this book is presented for academic study only !

END OF CAR BOMB RECOGNITION GUIDE BOOK (TEXT) .

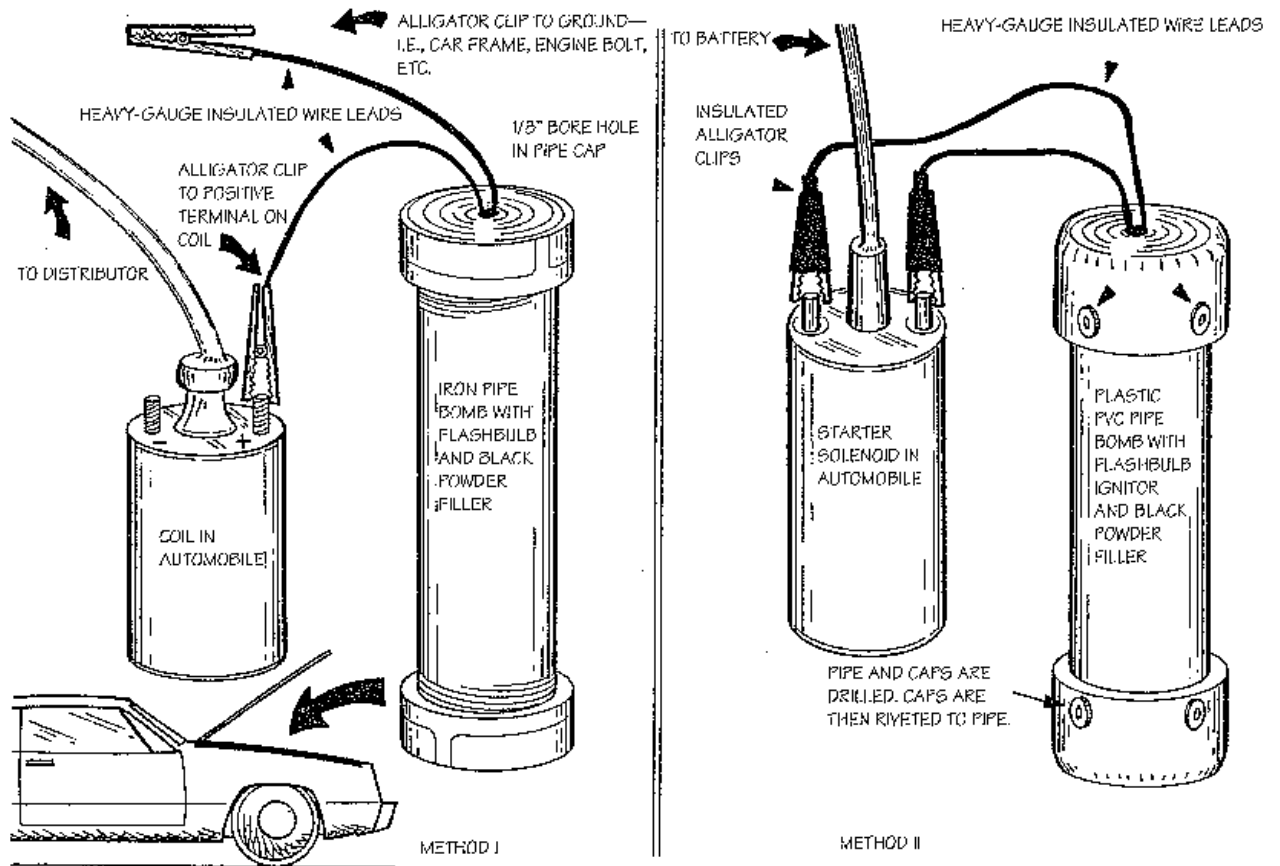

UNDER THE HOOD STANDARD CAR BOMB HOOK-UP METHODS

# IMPROVISED CAR BOMB NO. 1



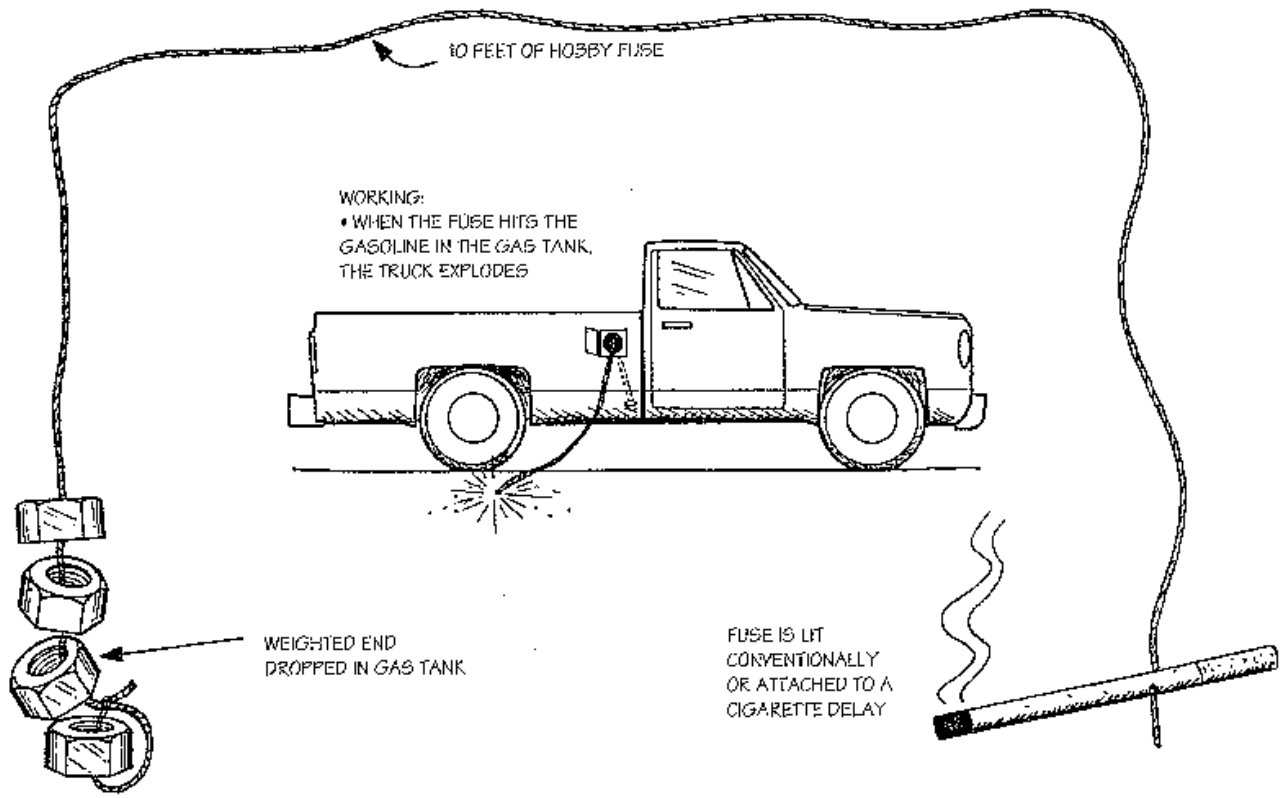

WEIGHTED FUSE DEVICE

# IMPROVISED CAR BOMB NO. 2

1/8" BORE HOLES IN PIPE  
CAPS FOR FUSES

IRON PIPE  
BOMBS FILLED  
WITH BLACK  
POWDER

PIPE BOMBS ARE  
PLACED ON THE LEFT  
SIDE OF THE ENGINE IN  
FRONT OF THE FIRE  
WALL (DRIVER'S SIDE)

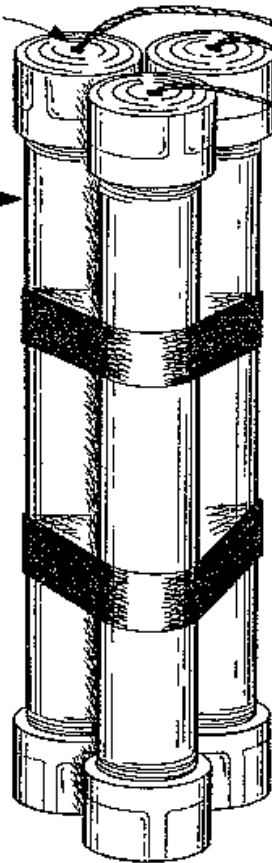

FUSE BUNDLE

WORKING:

- WHEN THE EXHAUST MANIFOLD GETS HOT ENOUGH, THE MATCH HEADS WILL LIGHT AND IGNITE THE FUSE
- WHEN THE FUSES ENTER THE PIPES, THEY EXPLODE

FUSE IS WRAPPED AROUND  
THE EXHAUST MANIFOLD

CLOSE-UP

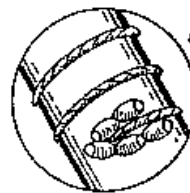

GLUE MATCH HEADS TO THE  
END OF THE FUSE

MANIFOLD FUSE IGNITION

# IMPROVISED CAR BOMB NO. 3

PACKING EACH MORTAR

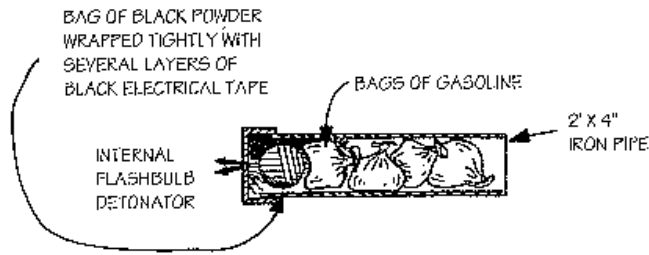

MODIFIED CABIN LAMP

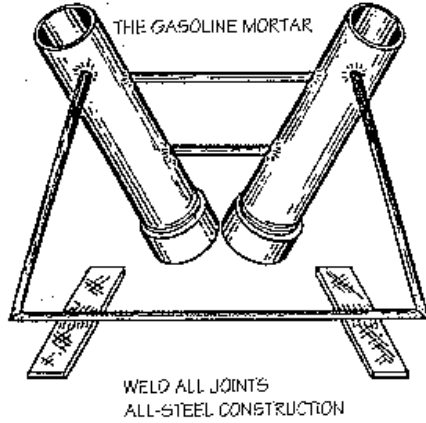
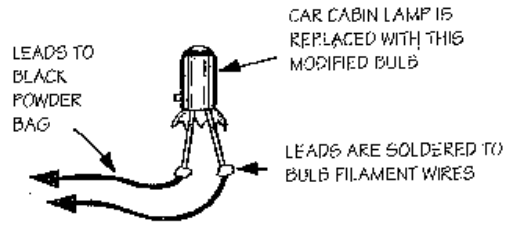

WORKING:

- POSITIVE BATTERY TERMINAL IS REMOVED
- LOADED MORTAR IS PLACED IN BACK SEAT AND CABIN LAMP REPLACED WITH MODIFIED BULB ABOVE
- CAR IS CLOSED AND BATTERY TERMINAL IS REPLACED
- WHEN THE VICTIM OPENS THE CAR DOOR, HE IS BLOWN BACK TO THE STONE AGE BY THE MORTARS

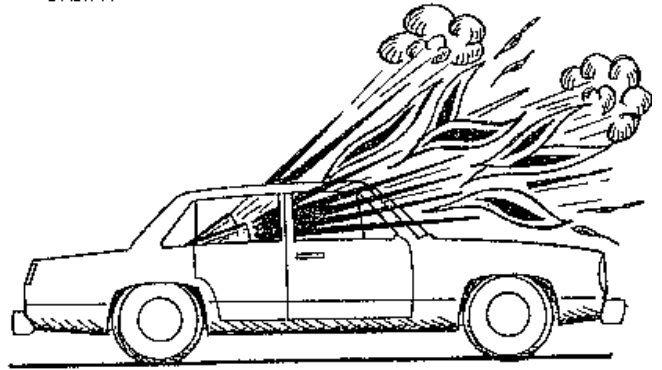

FIX GASOLINE MORTAR

# IMPROVISED CAR BOMB NO. 4

DEVICE CONSTRUCTION

1.

- SEVERAL ROWS OF PAPER MATCHES ARE REMOVED FROM A MATCHBOOK AND WRAPPED AROUND THE END OF A FLARE

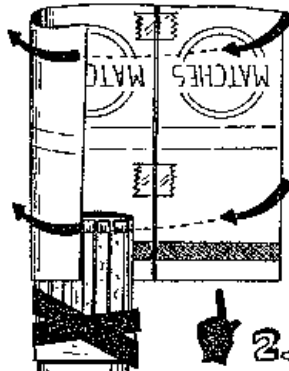

2.

- A FEW MATCHBOOK COVERS ARE TAPED TOGETHER AND WRAPPED AROUND THE MATCHES AND FLARE SO THE STRIKER RESTS BELOW THE MATCHES

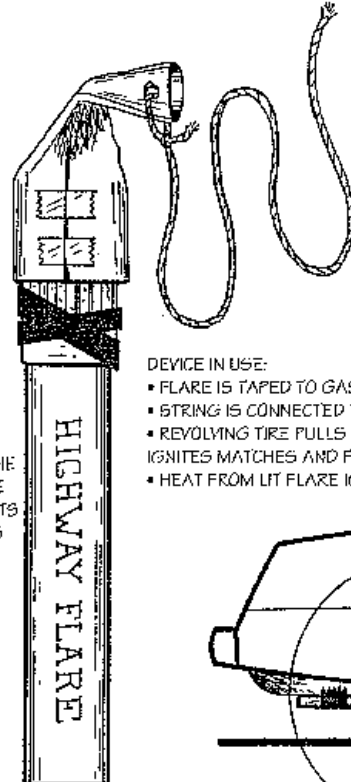

3.

- COVERS ARE TAPED CLOSED SO MATCHES ARE NOW ENCLOSED IN A STRIKER TUNNEL
- PULL STRING IS ATTACHED TO THE COVER/TUNNEL

DEVICE IN USE:

- FLARE IS TAPED TO GASOLINE TANK
- STRING IS CONNECTED TO AXLE
- REVOLVING TIRE PULLS STRING AND IGNITES MATCHES AND FLARE
- HEAT FROM LIT FLARE IGNITES GAS TANK

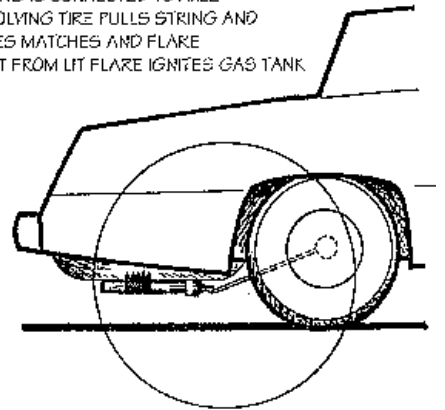

FLARE IGNITION DEVICE

# IMPROVISED CAR BOMB NO. 5

**WORKING:**

- STRING WINDS AROUND AXLE AS CAR MOVES IN EITHER DIRECTION
- THIS ACTION TRIPS THE MODIFIED MOUSETRAP AND FIRES THE SHOTGUN SHELL INTO THE GAS TANK

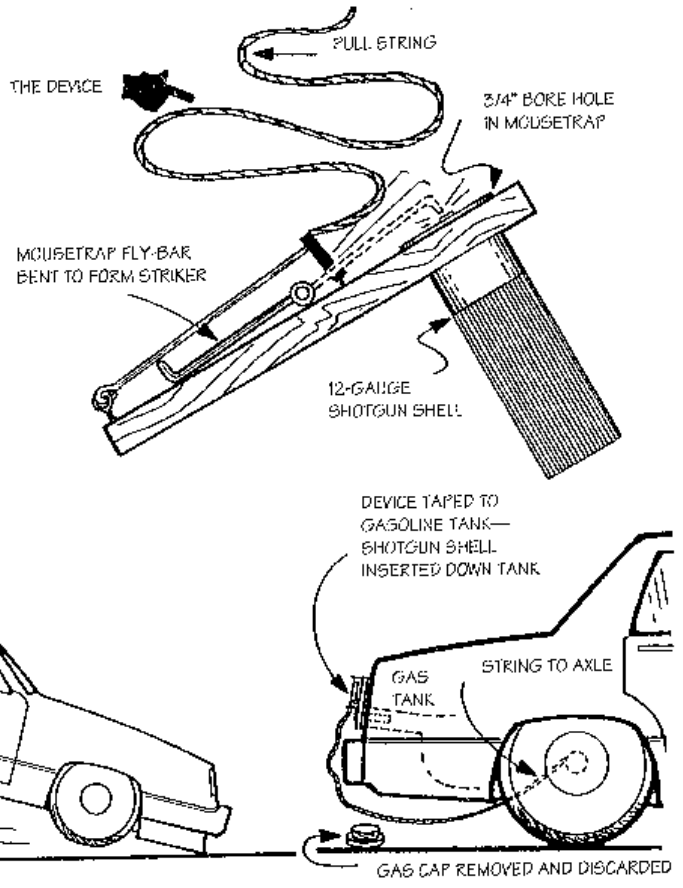
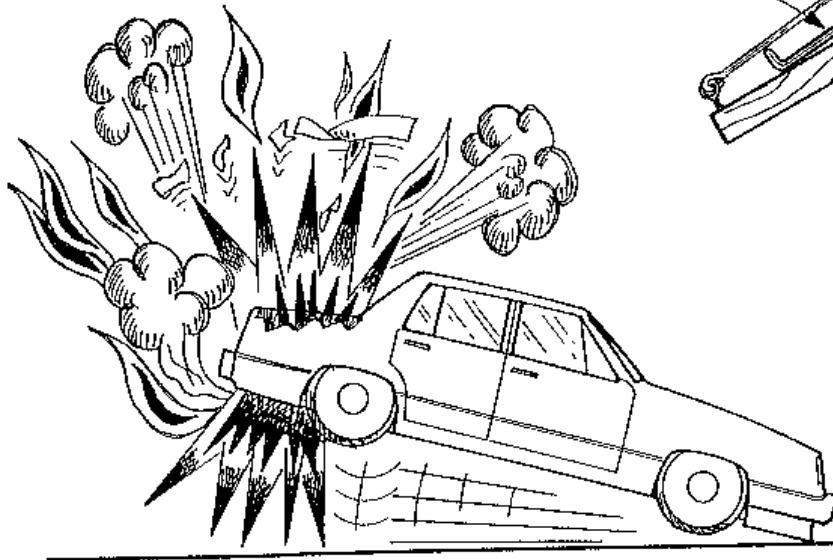

SHOTGUN SHELL DEVICE

# IMPROVISED CAR BOMB NO. 6

WORKING:

- TIMER COUNTS DOWN AND TILTS MERCURY SWITCH
- THIS ACTION COMPLETES THE ELECTRICAL CIRCUIT AND IGNITES THE MODEL ROCKET IGNITOR
- THE FLAME HEATS UP THE BULLET PRIMER AND FIRES BULLET INTO THE CAR'S GAS TANK
- THE GASOLINE TANK EXPLODES

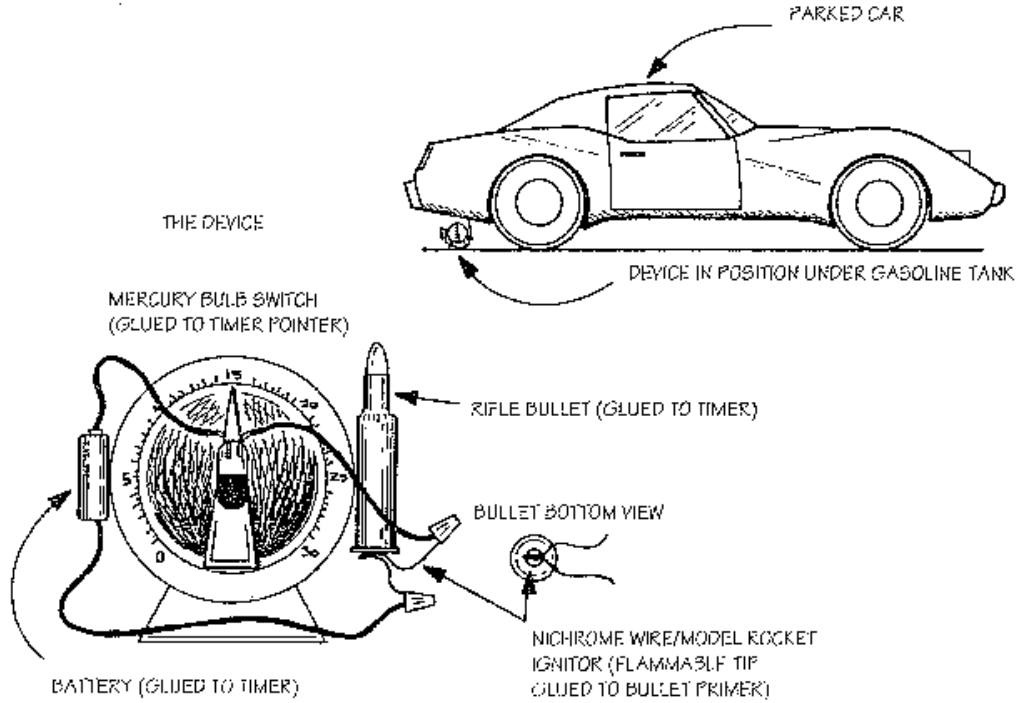

RIFLE BULLET TIMED-DELAY DEVICE

# IMPROVISED CAR BOMB NO. 7

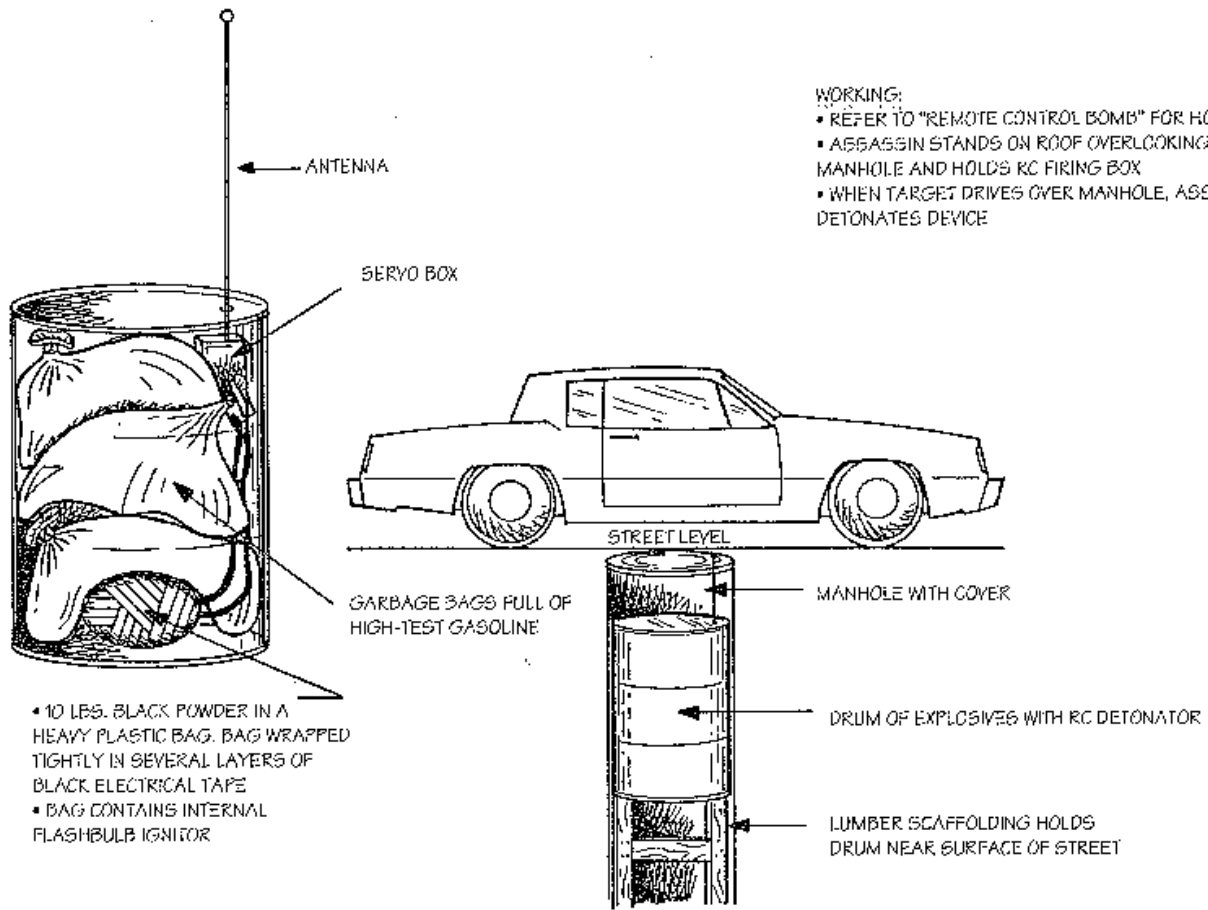

WORKING:

- REFER TO "REMOTE CONTROL BOMB" FOR HOOKUP
- ASSASSIN STANDS ON ROOF OVERLOOKING MANHOLE AND HOLDS RC FIRING BOX
- WHEN TARGET DRIVES OVER MANHOLE, ASSASSIN DETONATES DEVICE

- 10 LBS. BLACK POWDER IN A HEAVY PLASTIC BAG. BAG WRAPPED TIGHTLY IN SEVERAL LAYERS OF BLACK ELECTRICAL TAPE
- BAG CONTAINS INTERNAL FLASHBULB IGNITOR

MANHOLE DEVICE

# IMPROVISED CAR BOMB NO. 8

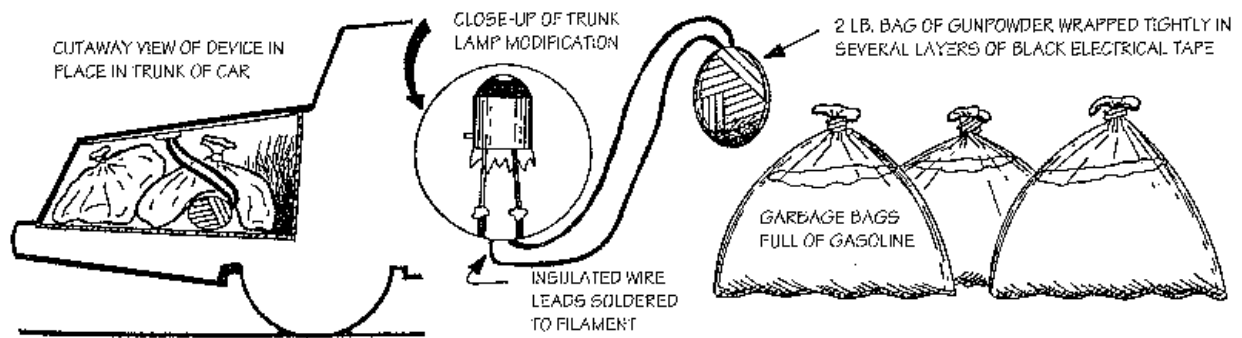

DEVICE EXPLODES WHEN TRUNK IS OPENED

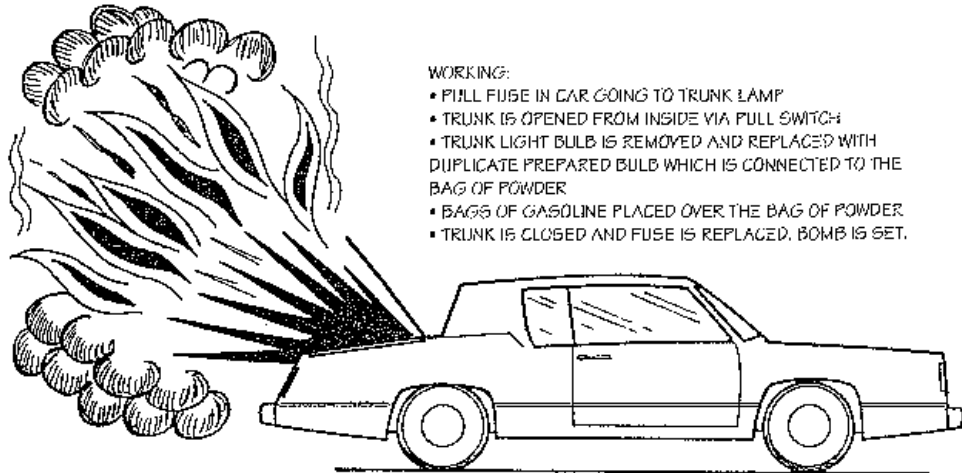

- WORKING:
- PULL FUSE IN CAR GOING TO TRUNK LAMP
  - TRUNK IS OPENED FROM INSIDE VIA PULL SWITCH
  - TRUNK LIGHT BULB IS REMOVED AND REPLACED WITH DUPLICATE PREPARED BULB WHICH IS CONNECTED TO THE BAG OF POWDER
  - BAGS OF GASOLINE PLACED OVER THE BAG OF POWDER
  - TRUNK IS CLOSED AND FUSE IS REPLACED. BOMB IS SET.

CHARLIE VARRICK REVISITED (TRUNK BOMB)

# IMPROVISED CAR BOMB NO. 9



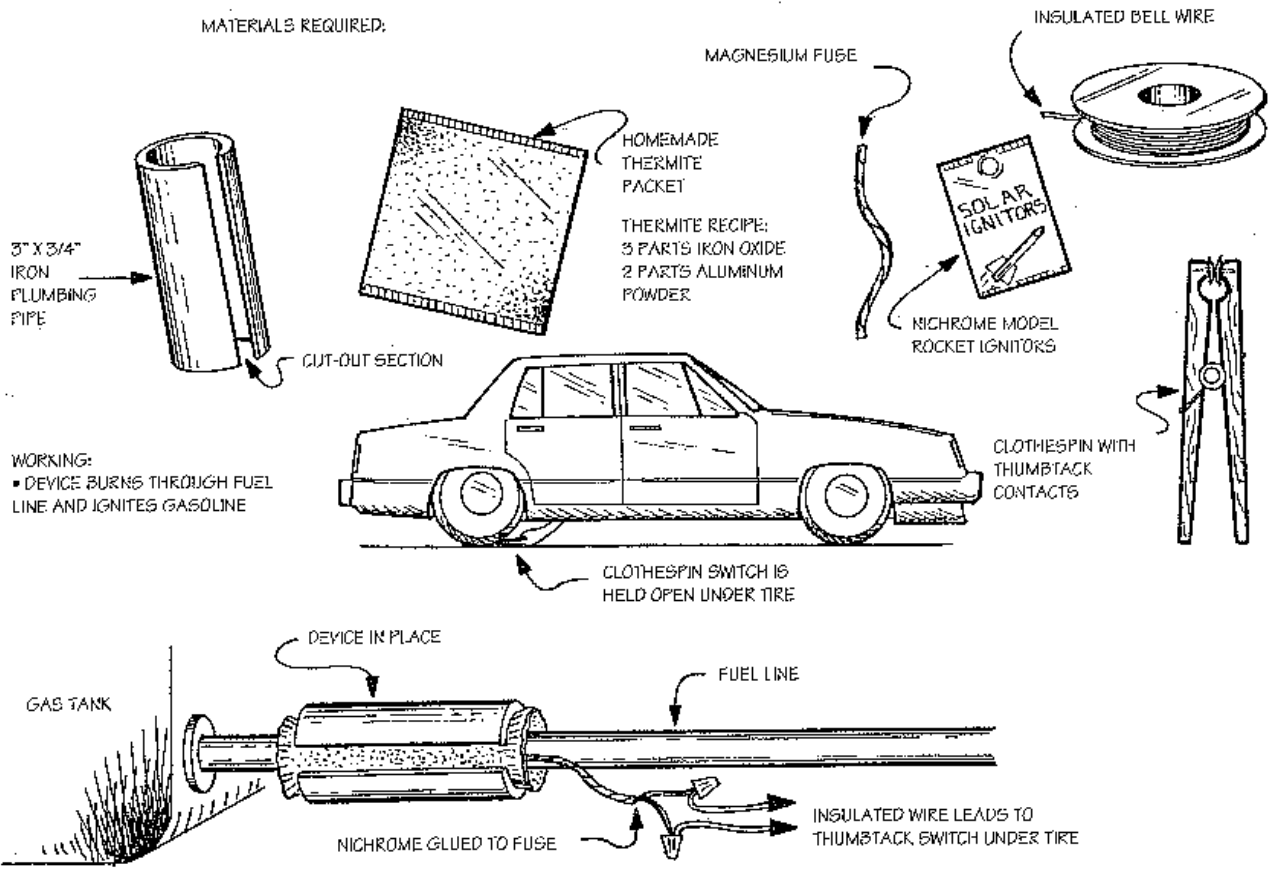

THERMITE DEVICE

# IMPROVISED CAR BOMB NO. 10

METHOD ONE

WORKING:  
VICTIM PUSHES DOWN ACCELERATOR.  
PIN IS PULLED ON GRENADE.  
GRENADE SPOON IS RELEASED AND  
GRENADE EXPLODES

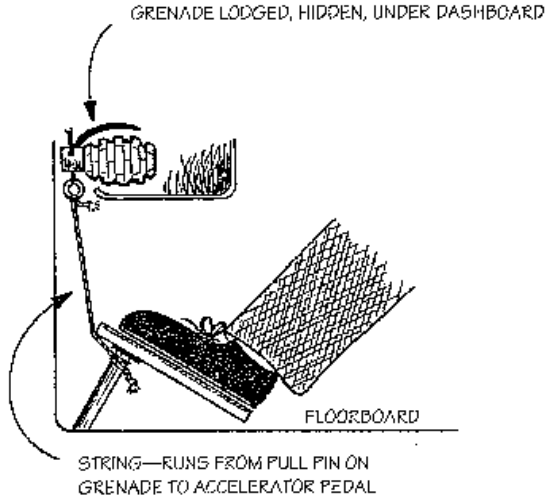

METHOD TWO

WORKING:  
AS CAR MOVES IN EITHER  
DIRECTION, THE STRING WINDS  
AROUND THE AXLE AND PULLS THE  
PIN ON THE GRENADE. THE SPOON  
EJECTS AUTOMATICALLY AND THE  
GRENADE EXPLODES

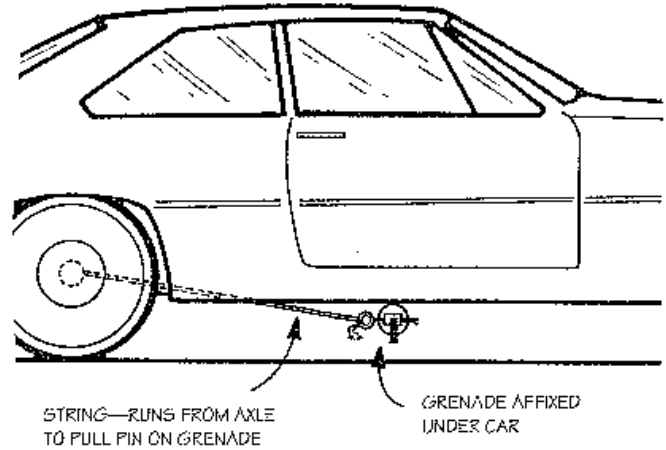

GRENADE TRICKS

# IMPROVISED CAR BOMB NO. 11

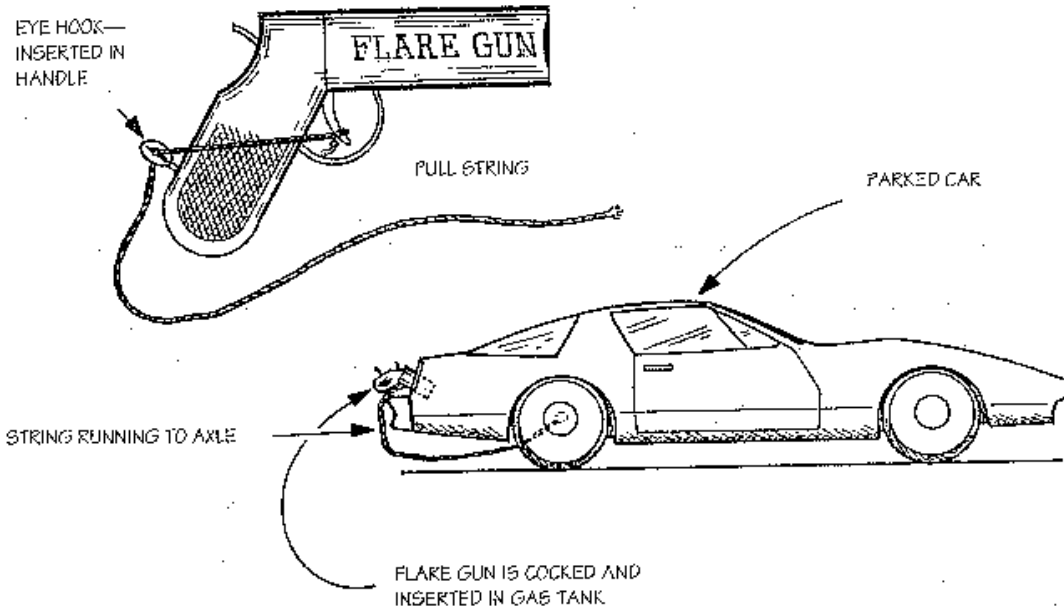

WORKING:

- STRING WINDS AROUND AXLE AS CAR MOVES IN EITHER DIRECTION. THIS ACTION PULLS THE TRIGGER ON THE FLARE GUN AND FIRES IT INTO THE GAS TANK.

FLARE GUN IGNITION

# IMPROVISED CAR BOMB NO. 12

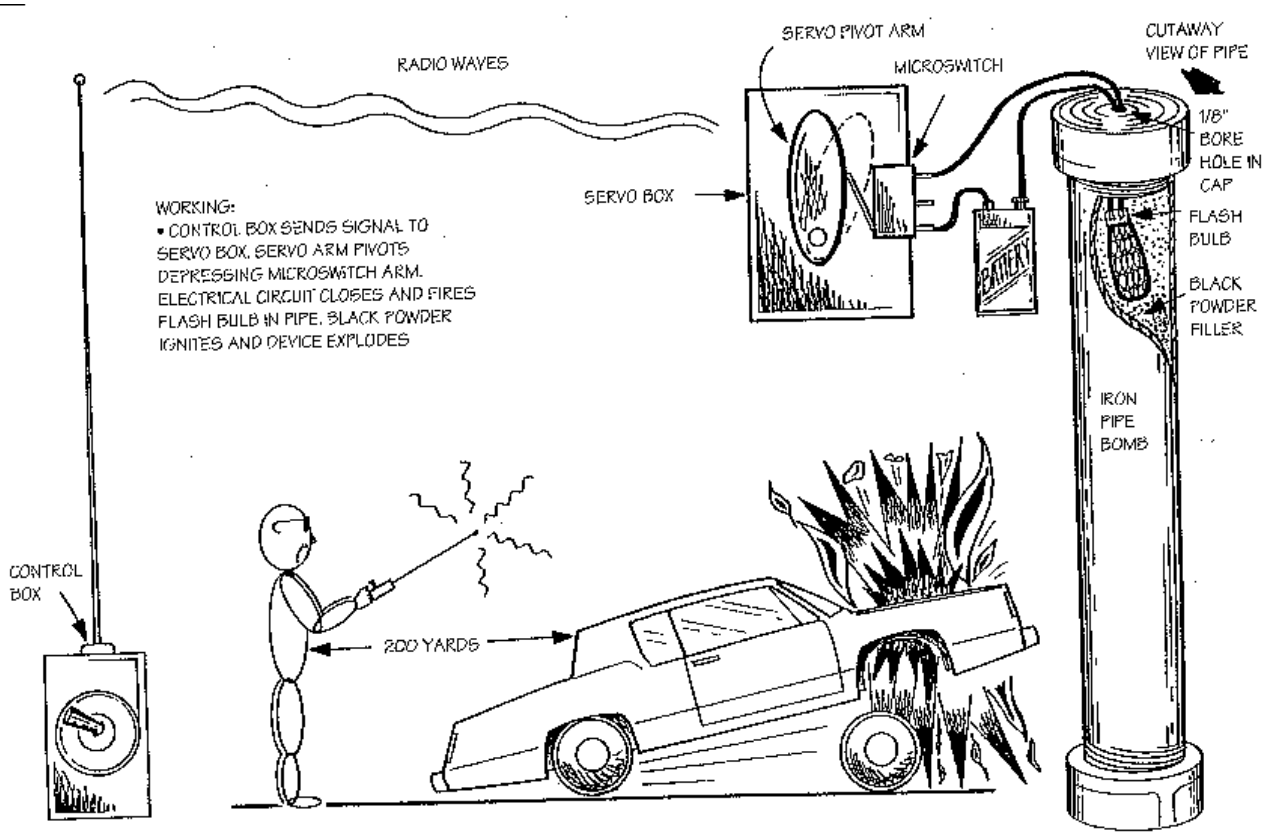

REMOTE CONTROL BOMB

# IMPROVISED CAR BOMB NO. 13

• THE TOY REMOTE CONTROL CAR CONTAINS THE BOMB, WHICH IS ALSO DETONATED BY REMOTE CONTROL

• THE OBJECT OF THIS CAT-AND-MOUSE GAME IS TO CATCH THE VICTIM AT A STOP SIGN OR RED LIGHT. THE CHASE TEAM THEN BACKS OFF AND RUNS THE TOY RC CAR UNDER GAS TANK OF THE TARGET CAR. IN THIS POSITION THE BOMB IS ARMED AND DETONATED BY THE DIRECTING ASSASSIN WITH THE RC CONTROL BOX

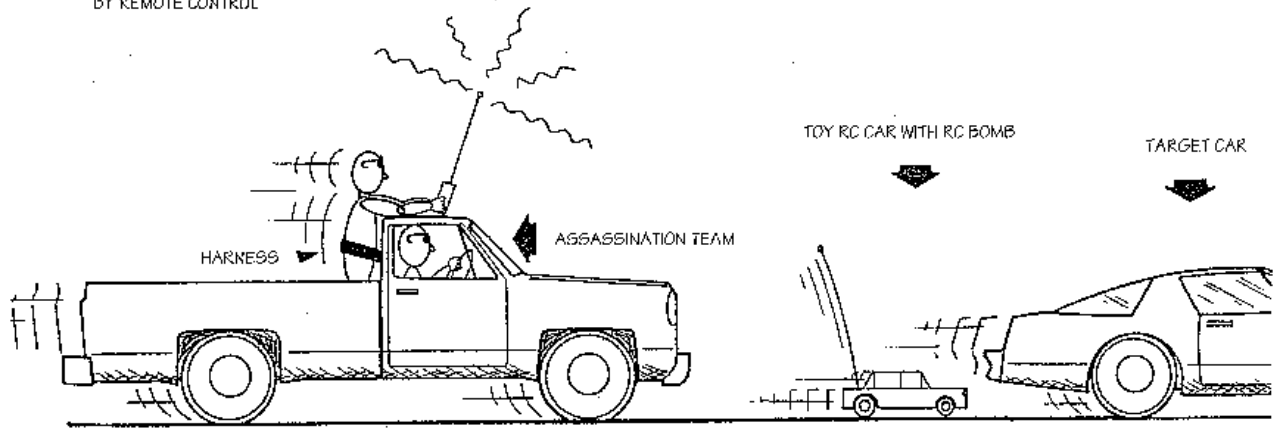

TOY REMOTE CONTROL DEVICE

# IMPROVISED CAR BOMB NO. 14

WORKING:

- GARAGE DOOR OPENER AND THE BOMB HIDDEN IN A CAR ARE PLACED ALONG THE ROAD WHERE THE VICTIM DRIVES DAILY
- PREPARED HAND-HELD REMOTE IS PLACED UNDER THE TARGET'S CAR
- WHEN THE VICTIM DRIVES BY THE CAR CONTAINING THE BOMB, THE GARAGE DOOR OPENER PICKS UP THE SIGNAL AND FIRES THE DEVICE

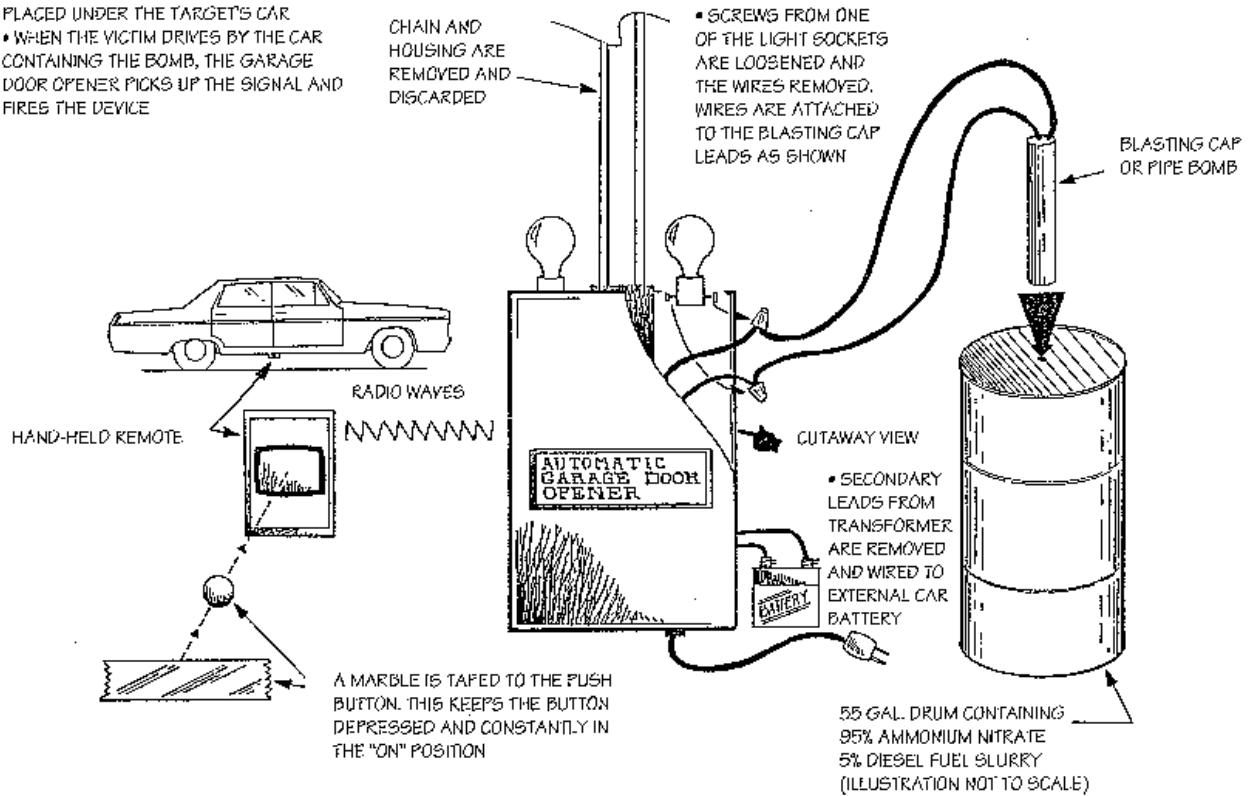

GARAGE DOOR OPENER BOMB

# IMPROVISED CAR BOMB NO. 15

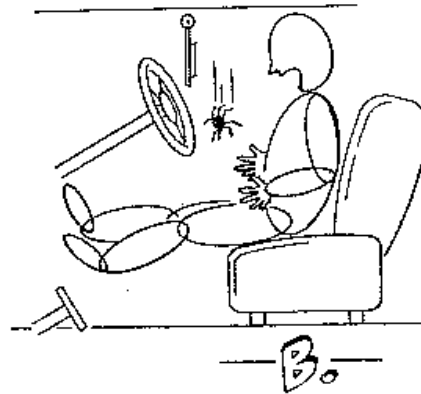
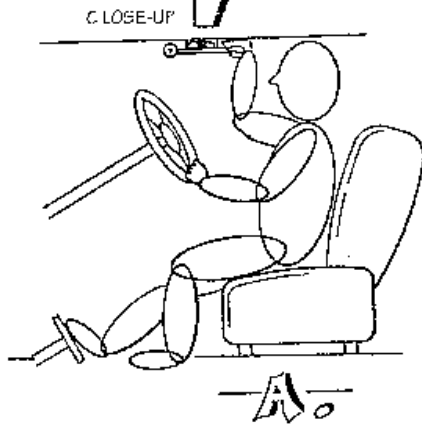
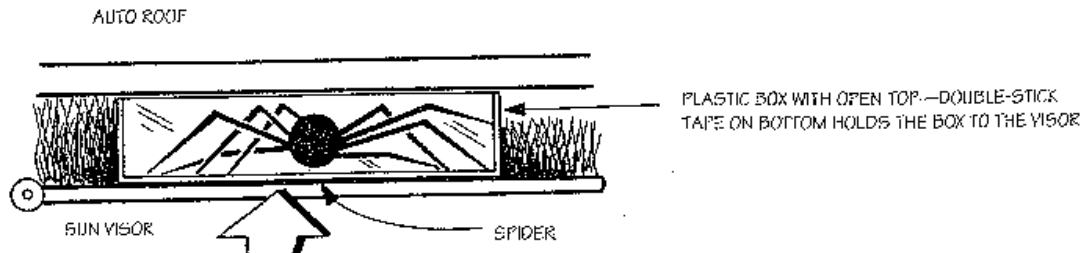

WORKING:

- THE SPIDER IS PLACED IN THE PLASTIC BOX SO IT IS TRAPPED BETWEEN THE ROOF OF THE CAR AND THE BOTTOM OF THE PLASTIC BOX AND SUN VISOR ON THE BOTTOM
- WHEN THE VICTIM PULLS THE VISOR DOWN, THE SPIDER IS RELEASED AND FALLS IN HIS LAP
- IF THE VICTIM IS DRIVING, HE COULD WRECK HIS CAR

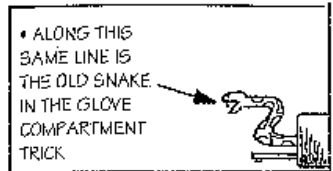

POISONOUS INSECT TRAP

# IMPROVISED CAR BOMB NO. 16

WORKING:  
WHEN THE MODIFIED BULLET HITS THE  
METAL UPON ENTERING THE GAS  
TANK, THE LIGHTER FLINT SPARKS  
AND DETONATES THE GAS TANK

TARGET—GASOLINE TANK

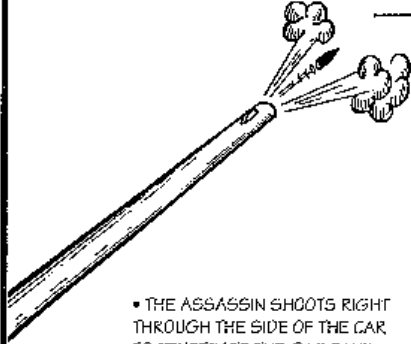
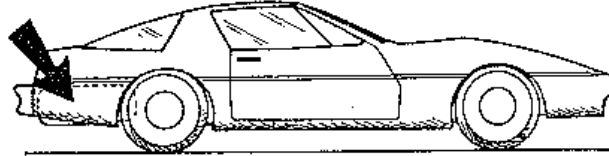

• THE ASSASSIN SHOOTS RIGHT  
THROUGH THE SIDE OF THE CAR  
TO PENETRATE THE GAS TANK

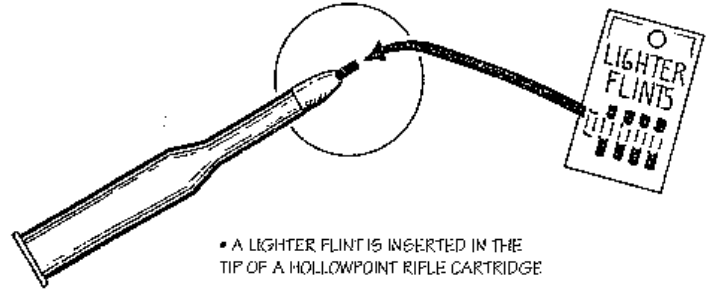

• A LIGHTER FLINT IS INSERTED IN THE  
TIP OF A HOLLOWPOINT RIFLE CARTRIDGE

LONG-RANGE RIFLE DETONATION

# IMPROVISED CAR BOMB NO. 17



WORKING:  
WHEN THE MODIFIED BULLET HITS THE  
METAL UPON ENTERING THE GAS  
TANK, THE LIGHTER FLINT SPARKS  
AND DETONATES THE GAS TANK

TARGET—GASOLINE TANK

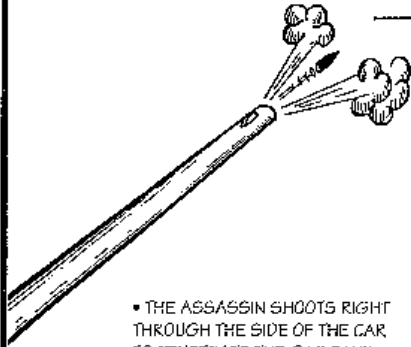
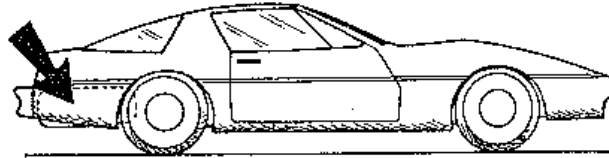

• THE ASSASSIN SHOOTS RIGHT  
THROUGH THE SIDE OF THE CAR  
TO PENETRATE THE GAS TANK

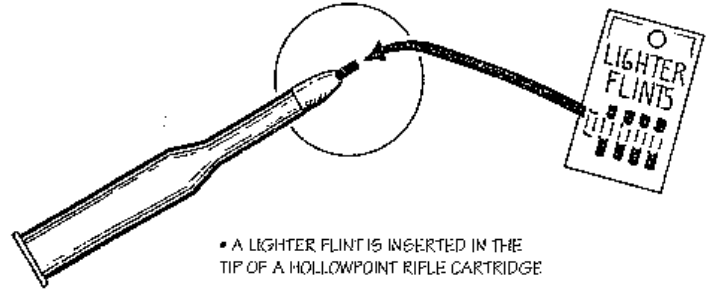

• A LIGHTER FLINT IS INSERTED IN THE  
TIP OF A HOLLOWPOINT RIFLE CARTRIDGE

LONG-RANGE RIFLE DETONATION

# IMPROVISED CAR BOMB NO. 17

MATERIALS:

SOLID LITTLE RUBBER BALL



SEVERAL PACKS OF LIGHTER FLINTS

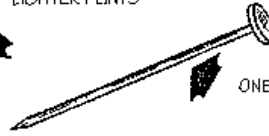

ONE NAIL

OPTIONS:

- FOR A DELAY, THE DEVICE IS ENCLOSED IN A BALLOON. THE GASOLINE WILL EVENTUALLY EAT THROUGH THE BALLOON AND RELEASE THE BALL
- YET ANOTHER DELAY WOULD BE TO AFFIX THE DEVICE TOP TO THE INSIDE OF THE GAS CAP WITH A HEAVY BEESWAX PELLETT. HEAT, SUCH AS A SUMMER MIDDAY HEAT, WILL MELT THE WAX AND THE DEVICE WILL DROP IN THE TANK

CONSTRUCTION AND WORKING:

- HOLES ARE POKED ALL AROUND THE BALL WITH THE NAIL
- LIGHTER FLINTS ARE INSERTED IN THESE HOLES SO THEY PROTRUDE SLIGHTLY
- DEVICE IS INSERTED IN THE ENEMY GASOLINE TANK. THE BALL WILL FALL TO THE BOTTOM OF THE TANK
- WHEN THE TANK IS ALMOST EMPTY, THE BALL WILL BEGIN BOUNCING AROUND. THE FLINT WILL SPARK ON THE SIDE OF THE TANK AND IGNITE THE GAS VAPORS. THE GAS TANK EXPLODES

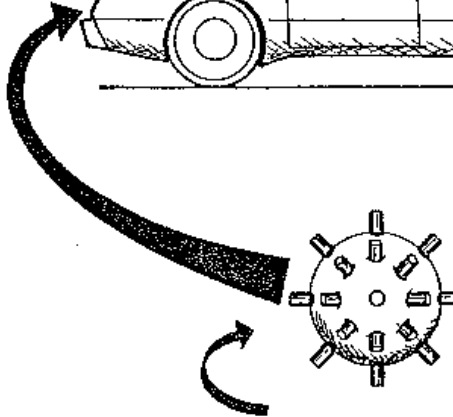
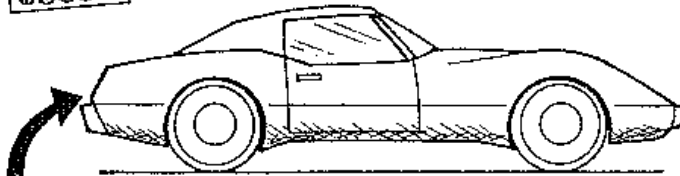

FINISHED DEVICE (ACTUAL SIZE)

BOUNCER

# IMPROVISED CAR BOMB NO. 18

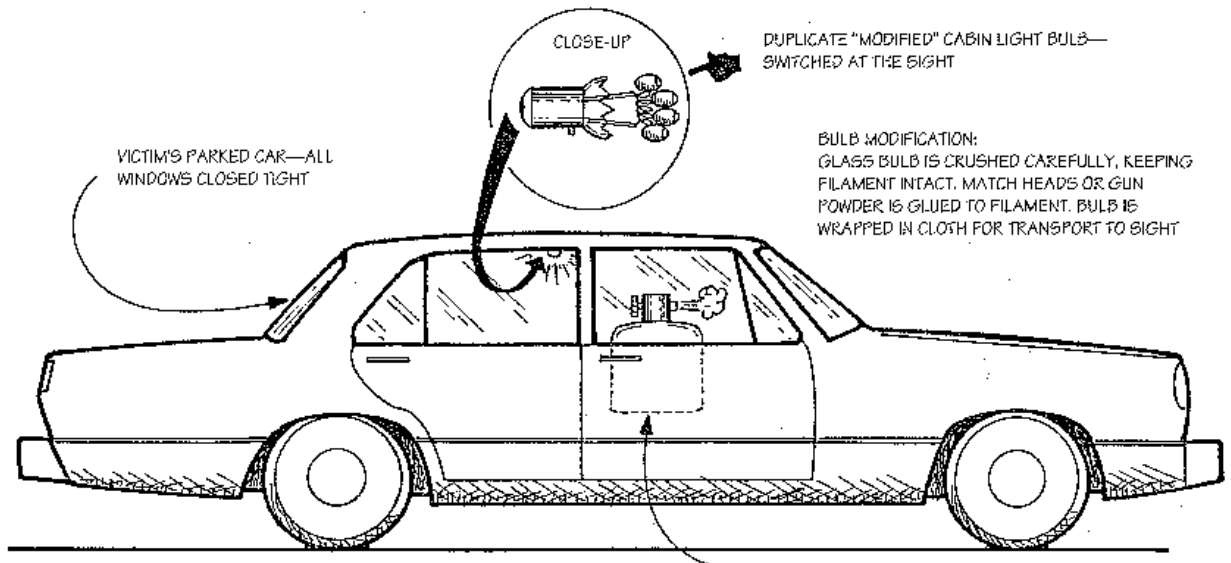

**WORKING:**

- ACCESS TO AUTOMOBILE INTERIOR IS GAINED AND HOOD IS OPENED VIA INTERNAL PULL SWITCH
- HOOD IS OPENED AND POSITIVE BATTERY TERMINAL REMOVED. ALL ELECTRICAL POWER TO CAR SHOULD NOW BE "OFF"
- CABIN LIGHT IN INTERIOR OF VEHICLE IS SWITCHED WITH THE MODIFIED BULB
- VALVE ON THE PROPANE TANK IS OPENED AND SET FOR A SLOW LEAK IF THE CAR WON'T BE OPENED OVERNIGHT
- CAR IS CLOSED BACK UP, THE BATTERY TERMINAL IS RECONNECTED, AND THE HOOD IS CLOSED
- WHEN VICTIM OPENS THE CAR, THE MODIFIED BULB IGNITES THE CABIN FULL OF FLAMMABLE GAS AND CAR EXPLODES

FULL PROPANE BOTTLE—NOZZLE OPENED FOR SLOW LEAK

**FLAMMABLE VAPOR TECHNIQUE**

# IMPROVISED CAR BOMB NO. 19

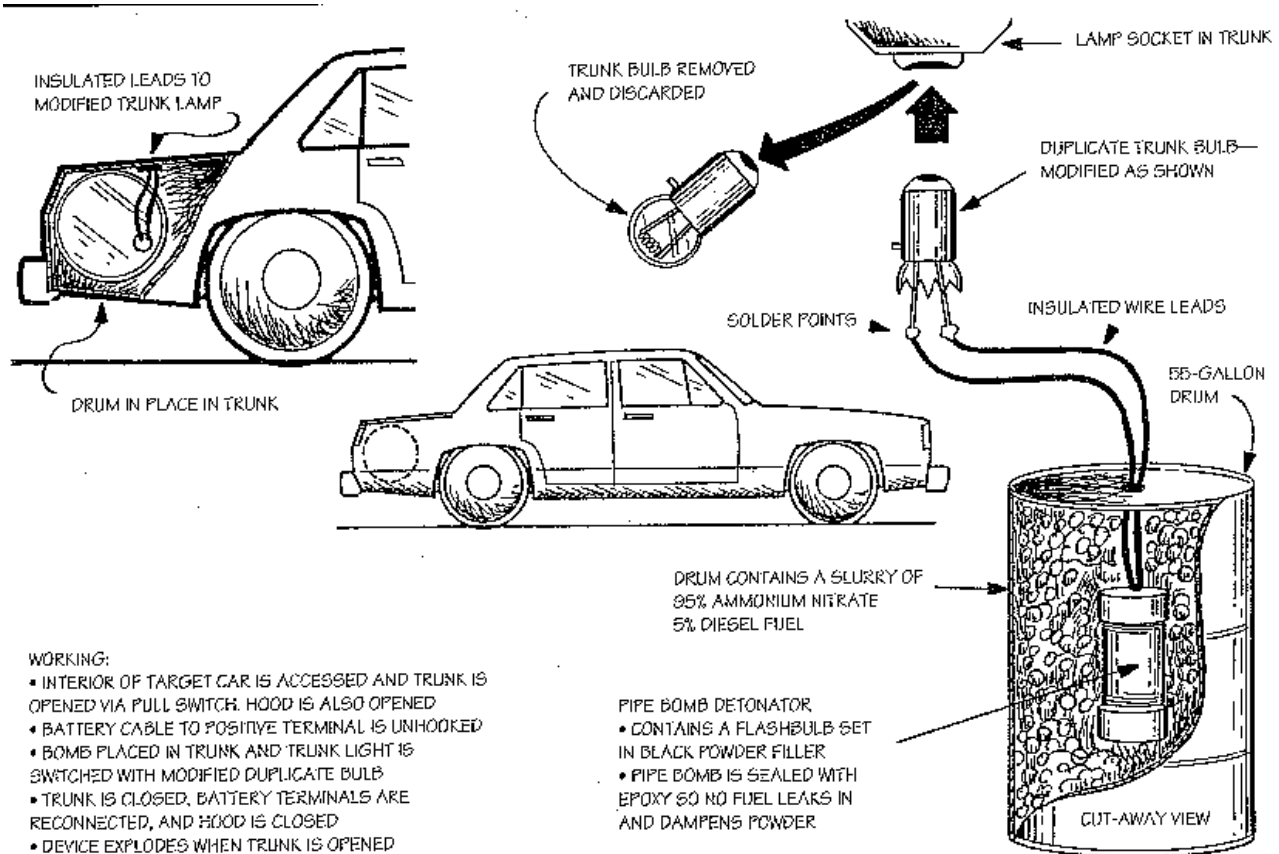

**WORKING:**

- INTERIOR OF TARGET CAR IS ACCESSED AND TRUNK IS OPENED VIA PULL SWITCH. HOOD IS ALSO OPENED
- BATTERY CABLE TO POSITIVE TERMINAL IS UNHOOKED
- BOMB PLACED IN TRUNK AND TRUNK LIGHT IS SWITCHED WITH MODIFIED DUPLICATE BULB
- TRUNK IS CLOSED, BATTERY TERMINALS ARE RECONNECTED, AND HOOD IS CLOSED
- DEVICE EXPLODES WHEN TRUNK IS OPENED

**PIPE BOMB DETONATOR**

- CONTAINS A FLASHBULB SET IN BLACK POWDER FILLER
- PIPE BOMB IS SEALED WITH EPOXY SO NO FUEL LEAKS IN AND DAMPENS POWDER

AMMONIUM NITRATE TRUNK BOMB

# IMPROVISED CAR BOMB NO. 20

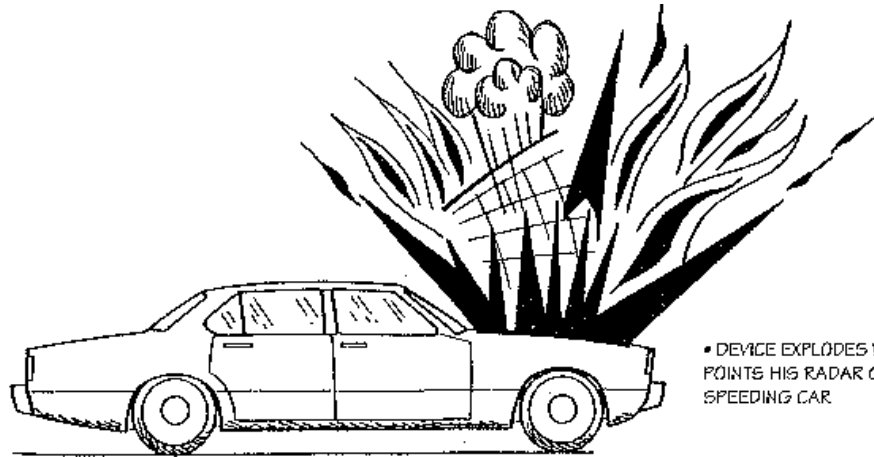

• DEVICE EXPLODES WHEN COP POINTS HIS RADAR GUN AT THE SPEEDING CAR.

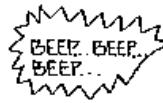

**RD MODIFICATION:**

- BEEPER IS CUT OFF AND DISCARDED
- BEEPER LEADS ATTACHED FROM DETECTOR DIRECTLY TO BOMB LEADS, EXPLOSIVE

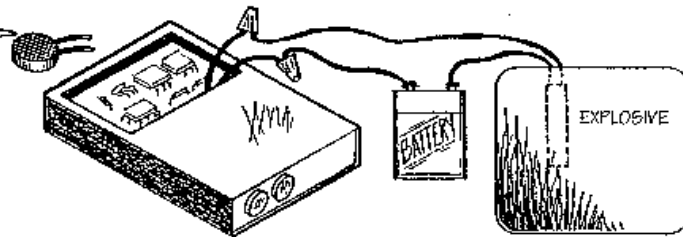

—THE DEVICE—



RADAR DETECTOR BOMB

# IMPROVISED CAR BOMB NO. 21

—METHOD ONE—

WORKING:

- CAR SPEEDS UP UNTIL SPEEDOMETER NEEDLE TOUCHES METAL SCREW
- BOMB CIRCUIT IS COMPLETED AND DEVICE EXPLODES

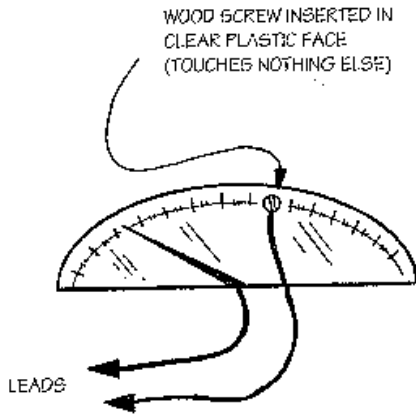

NOTE:  
EITHER OF THESE METHODS CAN BE  
APPLIED TO ALMOST ANY METER OR GAUGE

—METHOD TWO—

- CAR SPEEDS UP. SPEEDOMETER NEEDLE RISES, PAPER DIVIDER FALLS FREE
- VICTIM CANNOT SLOW DOWN OR NEEDLE WILL CONTACT SCREW, COMPLETE CIRCUIT, AND DETONATE BOMB

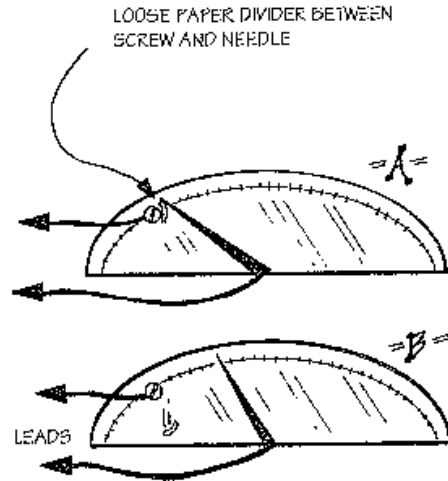

SPEEDOMETER DEVICES

# IMPROVISED CAR BOMB NO. 22

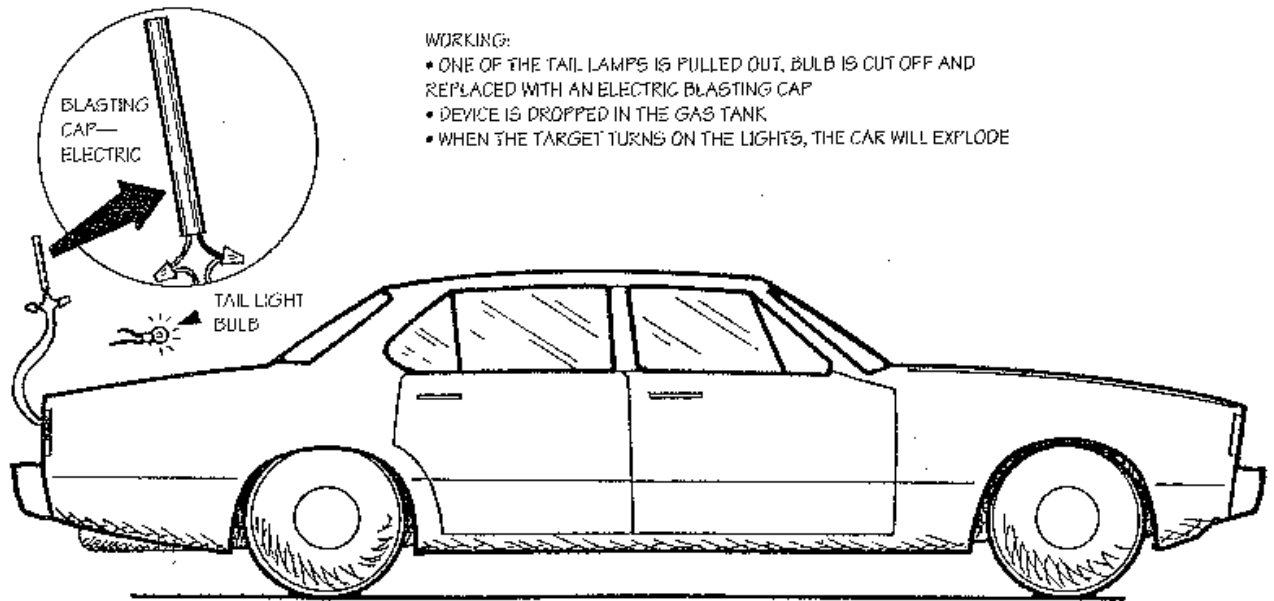

WORKING:

- ONE OF THE TAIL LAMPS IS PULLED OUT, BULB IS CUT OFF AND REPLACED WITH AN ELECTRIC BLASTING CAP
- DEVICE IS DROPPED IN THE GAS TANK
- WHEN THE TARGET TURNS ON THE LIGHTS, THE CAR WILL EXPLODE

OPTIONS:

- REAR TIRES DEFLATED AND REFILLED WITH FLAMMABLE ACETYLENE GAS
- GARBAGE BAGS FILLED WITH HIGH-TEST GASOLINE AND PLACED IN TRUNK

BLASTING CAP DEVICE

# IMPROVISED CAR BOMB NO. 23

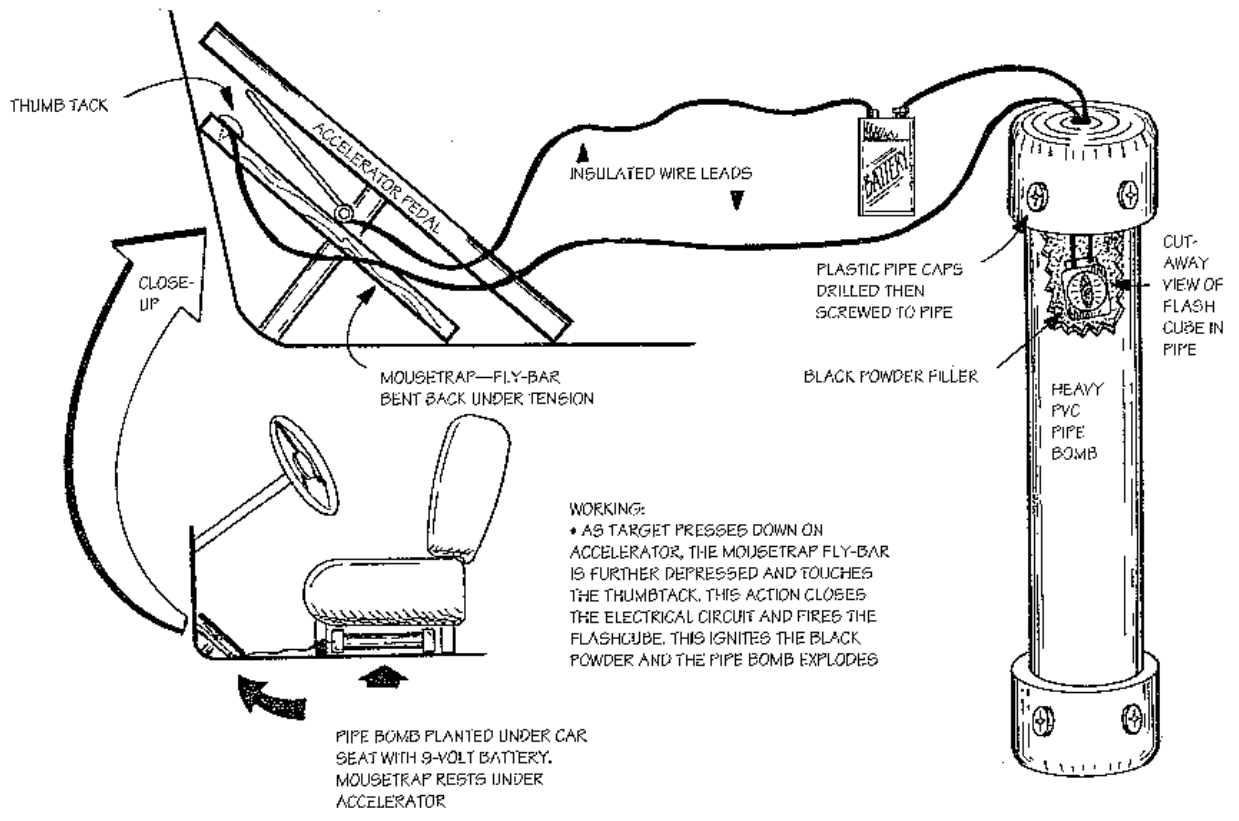

# IMPROVISED CAR BOMB NO. 24



WORKING:

- GASOLINE CAP IS REMOVED.
- WATER AND **WET GUNPOWDER** IS PLACED ON THE THREADS OF THE GAS CAP
- GAS CAP IS IMMEDIATELY SCREWED BACK ON. THE POWDER MUST BE VERY WET
- WHEN THE GUNPOWDER DRIES, THE BOMB IS SET
- WHEN THE VICTIM UNSCREWS THE GASOLINE CAP, THE METAL THREADS GRIND TOGETHER AND IGNITE THE GUNPOWDER. THIS IN TURN IGNITES THE GASOLINE VAPORS AND THE GAS TANK EXPLODES

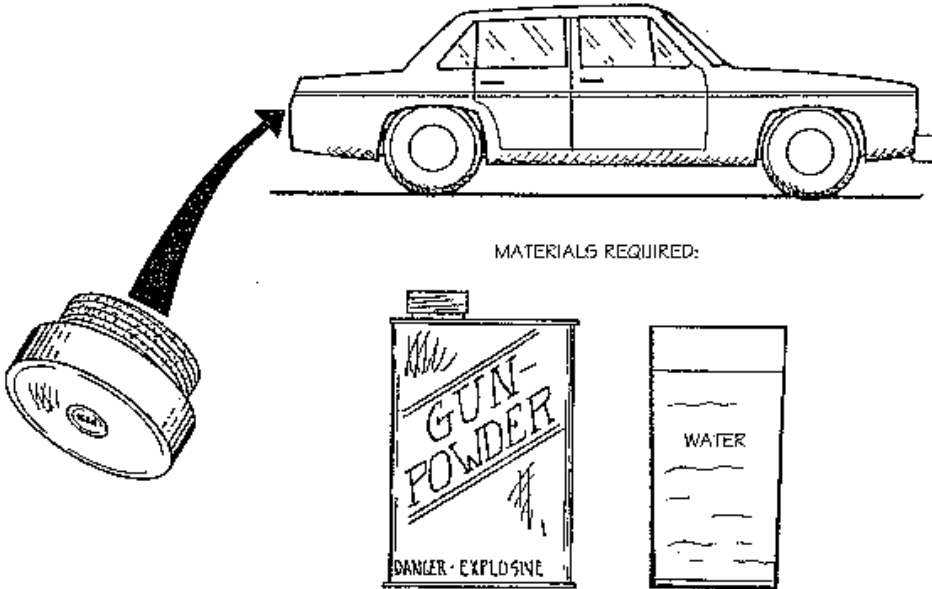

GIMMICKED GASOLINE CAP BOMB

# IMPROVISED CAR BOMB NO. 25

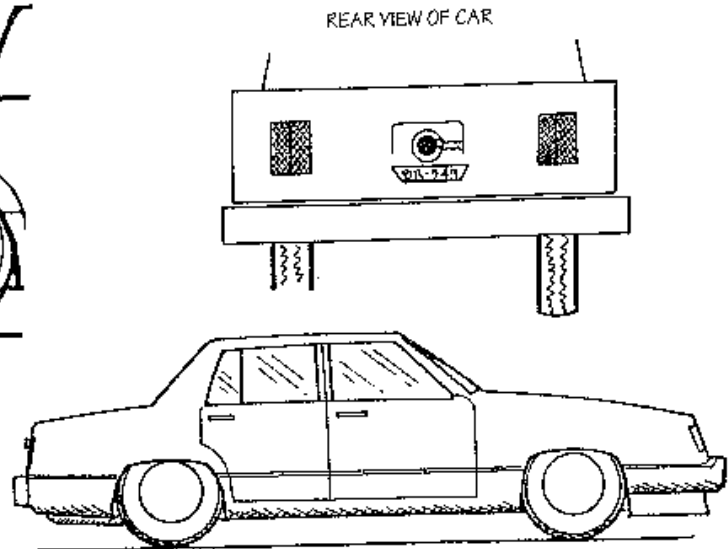
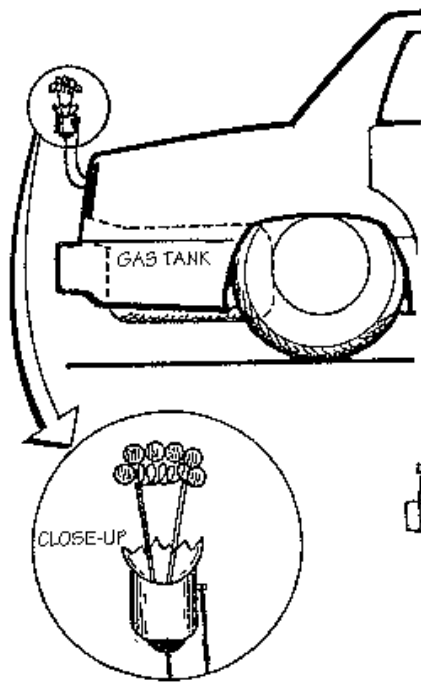

**WORKING:**

- REAR LICENSE PLATE LAMP IS REMOVED AND THE GLASS BULB CAREFULLY BROKEN SO THE FILAMENT REMAINS COMPLETELY INTACT
- MATCH HEADS ARE GLUED TO THE FILAMENT AND DROPPED IN THE GASOLINE TANK. THE INSULATED WIRE LEADS ALWAYS REMAIN CONNECTED TO THE BULB
- WHEN THE VICTIM TURNS ON HIS LIGHTS, THE BULB FIRES UP THE MATCH HEADS. THIS IGNITES THE GASOLINE VAPORS AND THE GASOLINE TANK EXPLODES

**GASOLINE TANK BOMB**

# **IMPROVISED CAR BOMB NO. 26**

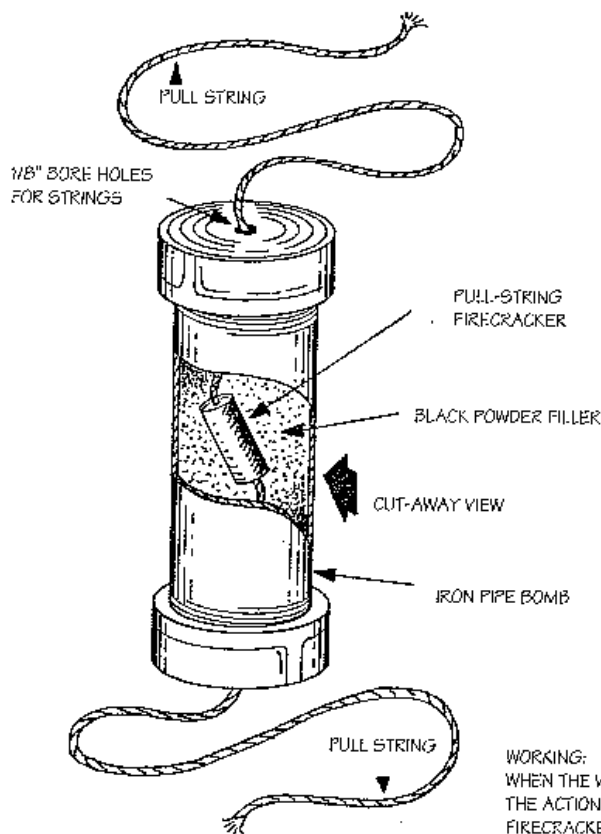

**NOTES:**

- THESE LITTLE FIRECRACKER TOYS WILL EASILY IGNITE CONFINED BLACK POWDER
- THEY CAN USUALLY BE PURCHASED EVEN IN STATES WHERE FIREWORKS ARE OUTLAWED

**OPTION:**

- THE BOMB COULD BE PLACED UNDER THE CAR AND EACH STRING TIED TO EACH AXLE. THE TURNING AXLES PULL THE STRINGS AND FIRE THE DEVICE

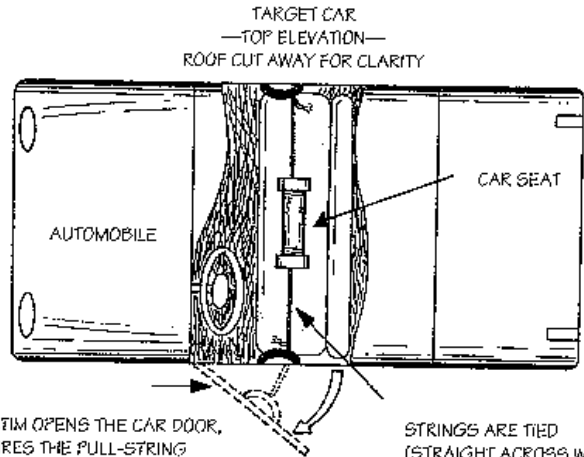

**WORKING:**  
WHEN THE VICTIM OPENS THE CAR DOOR,  
THE ACTION FIRES THE PULL-STRING  
FIRECRACKER IN THE PIPE FULL OF  
BLACK POWDER AND IT EXPLODES

**FIRECRACKER IGNITION**

# IMPROVISED CAR BOMB NO. 27

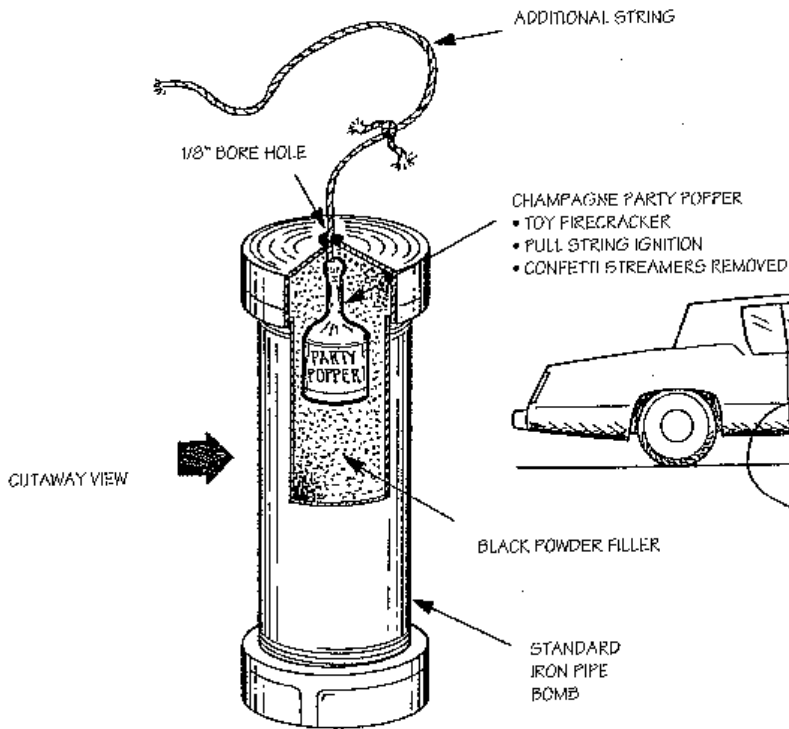

**WORKING:**  
 WHEN THE VICTIM OPENS THE BOOBY-TRAPPED CAR DOOR, THE STRING IS PULLED AND THE TOY PARTY POPPER FIRES INTO THE BLACK POWDER. THIS SPLIT-SECOND FLAME IGNITES THE POWDER AND FIRES THE BOMB

**NOTES:**

- A CHAMPAGNE POPPER COULD CONCEIVABLY BE RIGGED TO IGNITE A GASOLINE BOMB
- IT COULD EVEN BE SET UP TO FIRE DIRECTLY INTO A CAR'S GAS TANK

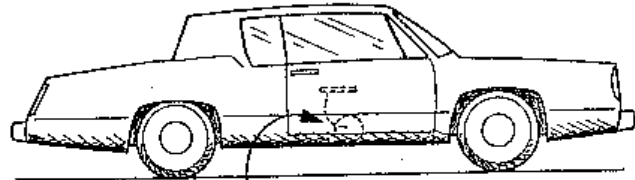

- PIPE BOMB IS WEDGED TIGHTLY UNDER THE CAR SEAT
- PULL STRING IS RUN TO THE ARMREST ON THE DOOR
- ILLUSTRATION SHOWS DEVICE RIGGED TO PASSENGER DOOR. DEVICE COULD BE CONNECTED TO EITHER CAR DOOR OR TO THE TRUNK OR HOOD

TOY PARTY POPPER IGNITION

# IMPROVISED CAR BOMB NO. 28

• THE PROPANE BOTTLE WILL EVENTUALLY BLOW UP FROM THE HEAT. DELAY UNKNOWN

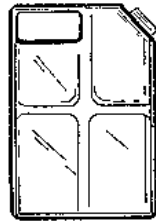
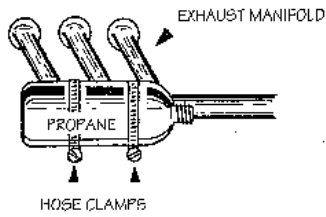

WATER IS EMPTIED OUT OF THE RADIATOR OF THE TARGET CAR AND REFILLED WITH GASOLINE. THE CAR WILL EXPLODE AND BURN UP SHORTLY

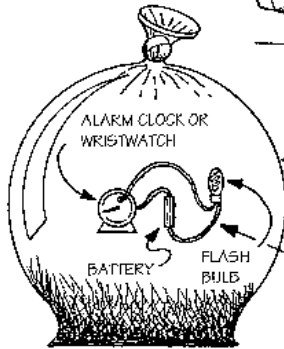
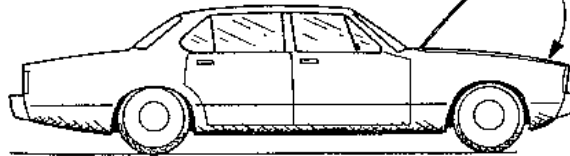
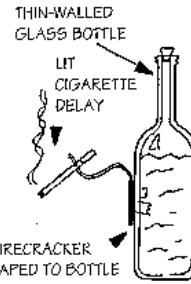

GARBAGE BAG FULL OF FLAMMABLE GAS SUCH AS ACETYLENE OR PROPANE

THE FIRING CIRCUIT IS INSIDE THE BAG

MODIFIED TAIL LAMP BULB

SOLDER POINTS

WHEN VICTIM TURNS ON HIS LIGHTS, THE BAG EXPLODES

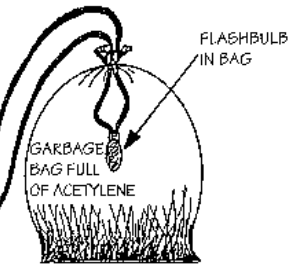

PLACE BAG(S) IN TRUNK OF TARGET CAR

MISCELLANEOUS DEVICES AND METHODS

# IMPROVISED CAR BOMB NO. 29

DOWNWARD PRESSURE OF "SITTING" ON CAR SEAT PULLS STRING AND FIRES DEVICE

DEVICE IN USE

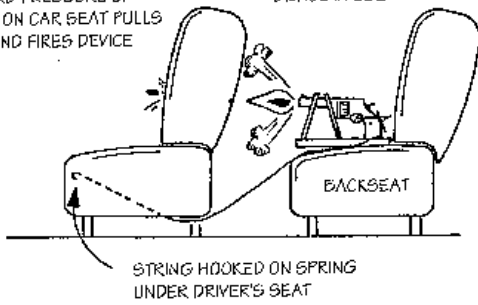

• EACH STAND IS BUILT AS SHOWN BELOW. SPECS VARY

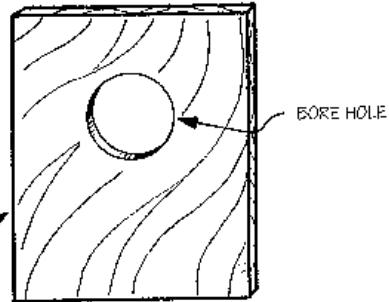

WORKING:

WHEN VICTIM SITS DOWN IN THE DRIVER'S SEAT, HIS WEIGHT PULLS THE STRING AND FIRES THE MOUSETRAP. THE FLY-BAR PULLS THE TRIGGER ON GUN, WHICH FIRES ONE ROUND THROUGH THE DRIVER'S SEAT, HITTING THE VICTIM IN THE BACK

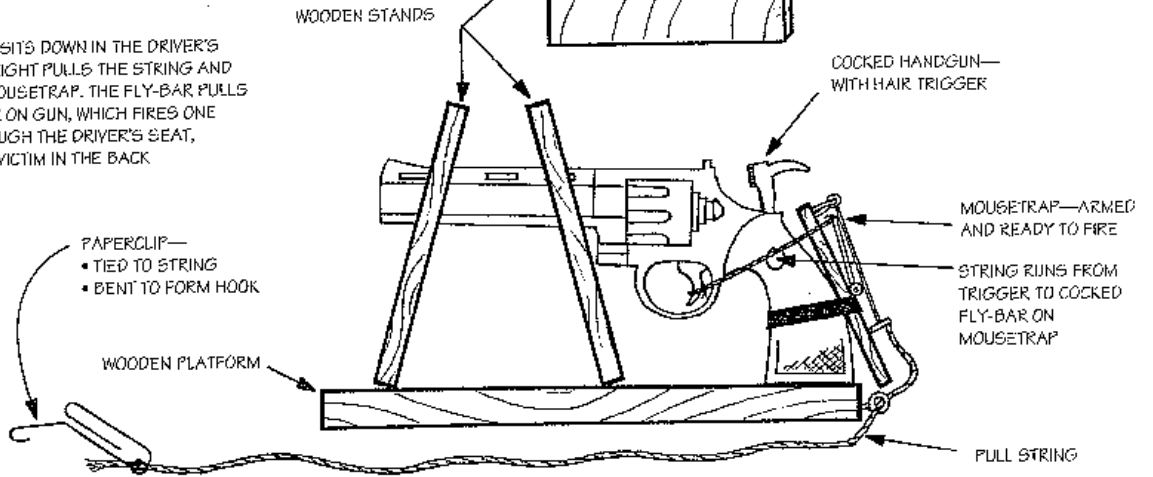

HANDGUN TRAP

# IMPROVISED CAR BOMB NO. 30

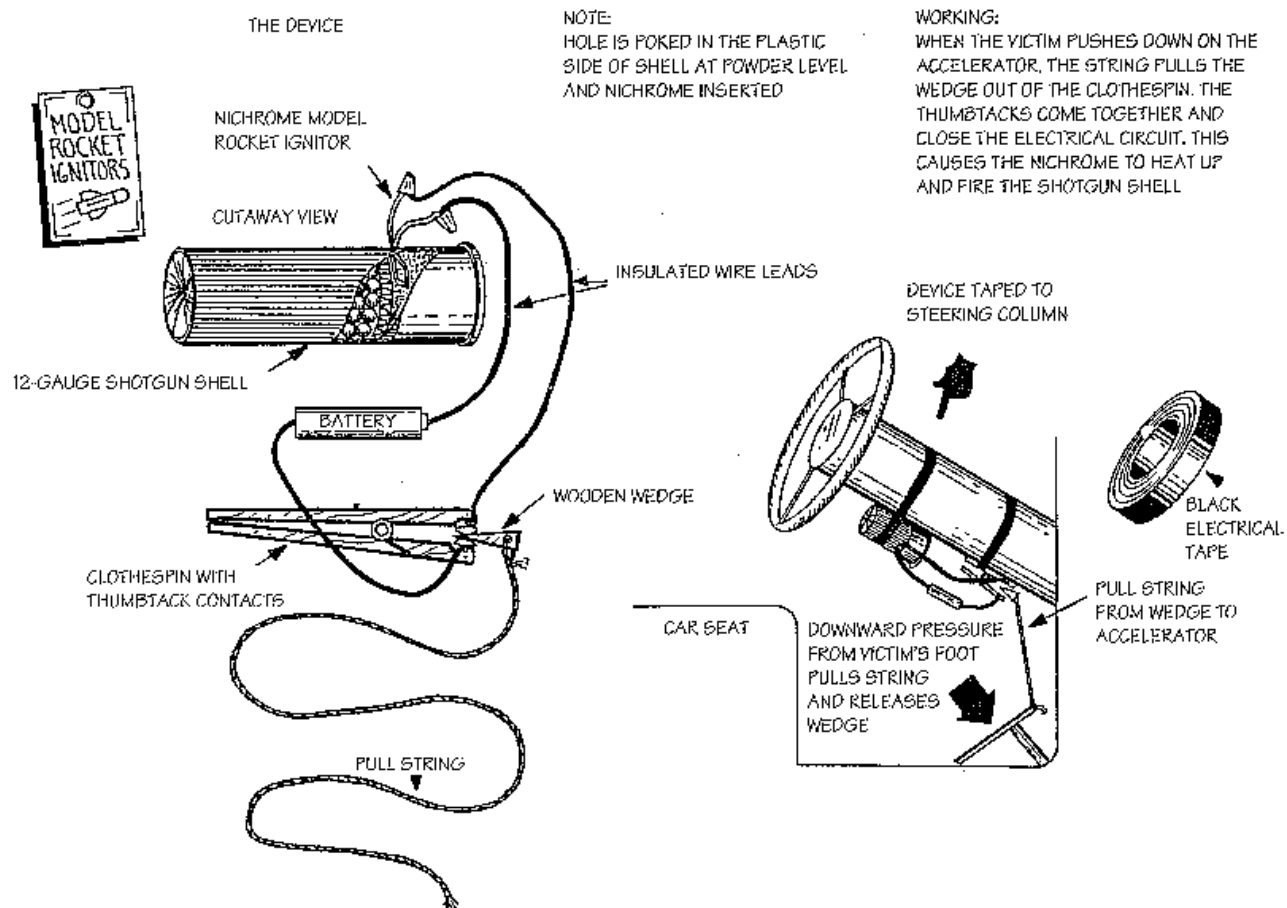

SHOTGUN SHELL BOBBY TRAP

# IMPROVISED CAR BOMB NO. 31

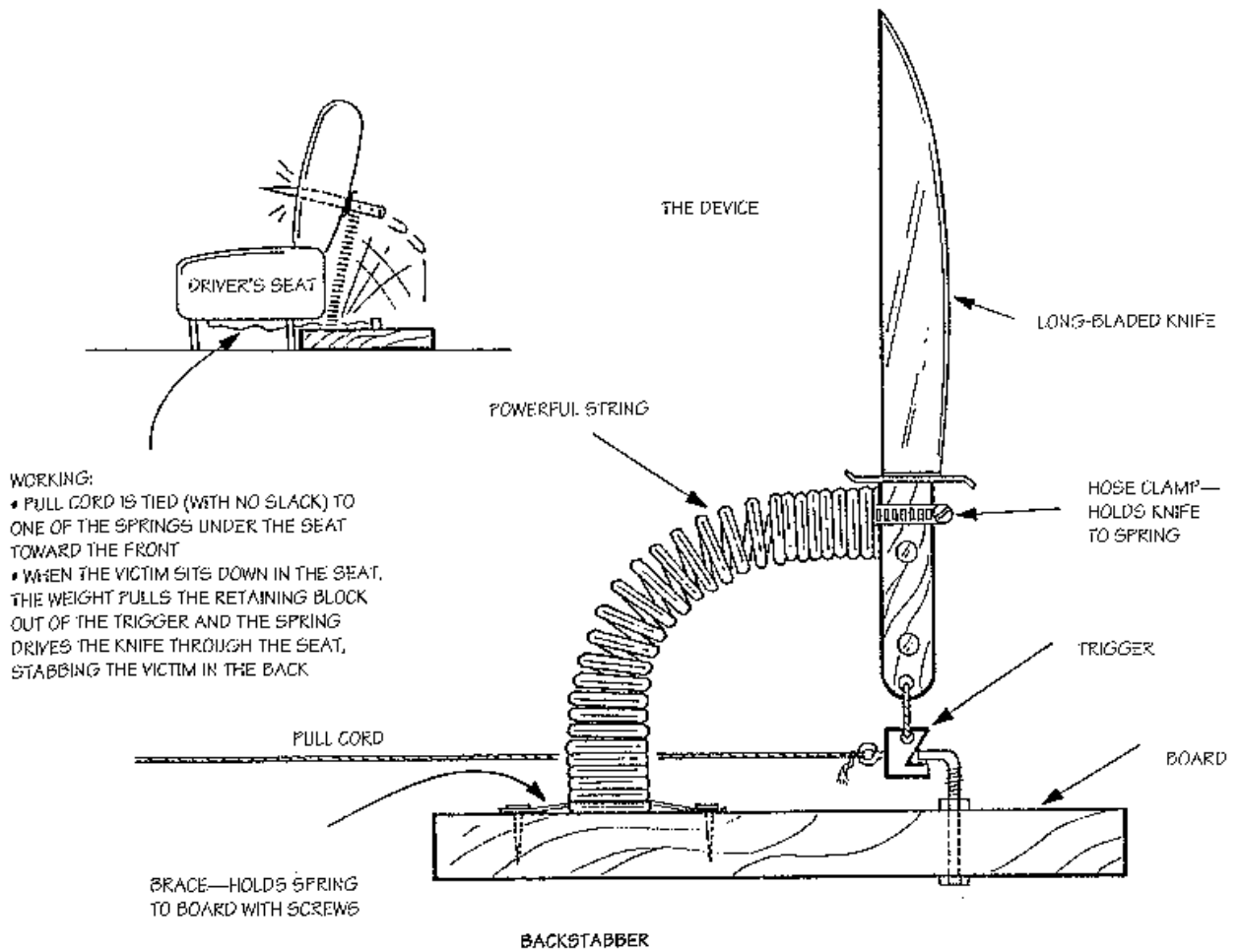

**WORKING:**

- PULL CORD IS TIED (WITH NO SLACK) TO ONE OF THE SPRINGS UNDER THE SEAT TOWARD THE FRONT
- WHEN THE VICTIM SITS DOWN IN THE SEAT, THE WEIGHT PULLS THE RETAINING BLOCK OUT OF THE TRIGGER AND THE SPRING DRIVES THE KNIFE THROUGH THE SEAT, STABBING THE VICTIM IN THE BACK

# **IMPROVISED CAR BOMB NO. 32**



DEVICE IS PLACED IN THE ROAD  
AROUND A SHARP CURVE SO IT  
WON'T BE SEEN UNTIL IT'S TOO LATE



DRIVER SPEEDING ALONG ROAD BELIEVES HE IS ABOUT  
TO BE IN A HEAD-ON COLLISION, SWERVES OFF ROAD

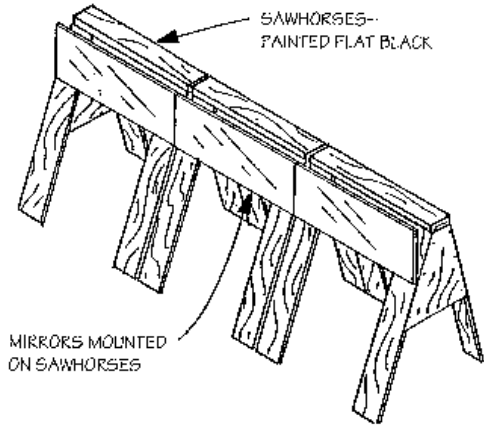

HIGHWAY MIRROR DECEPTION

WORKING:  
AS WITH THE PREVIOUS DEVICE,  
THIS ONE IS SET IN THE ROAD AT  
NIGHT FACING THE ONCOMING  
TARGET CAR. THE LIGHTS ARE SET  
ON A TIMER OR REMOTE CONTROL.

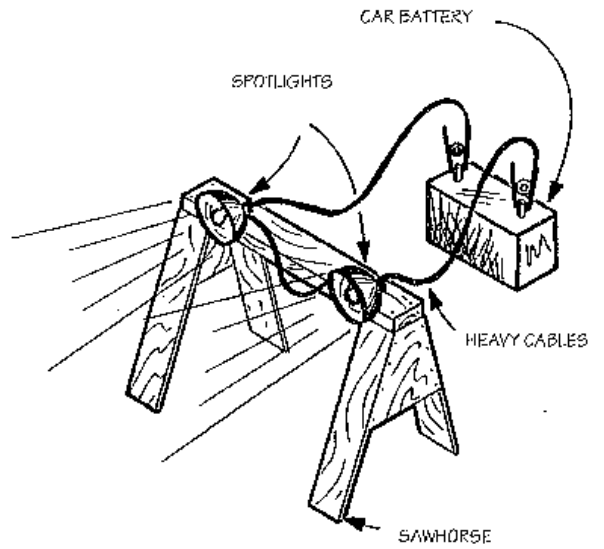

HIGHWAY SPOTLIGHT DECEPTION

# IMPROVISED CAR BOMB NO. 33

USED TO DELIVER A CAR  
LOAD OF EXPLOSIVES

VEHICLE IS CONTROLLED FROM A DISTANCE, SUCH  
AS FROM A HIGH-RISE STRUCTURE, ROOFTOP, ETC.

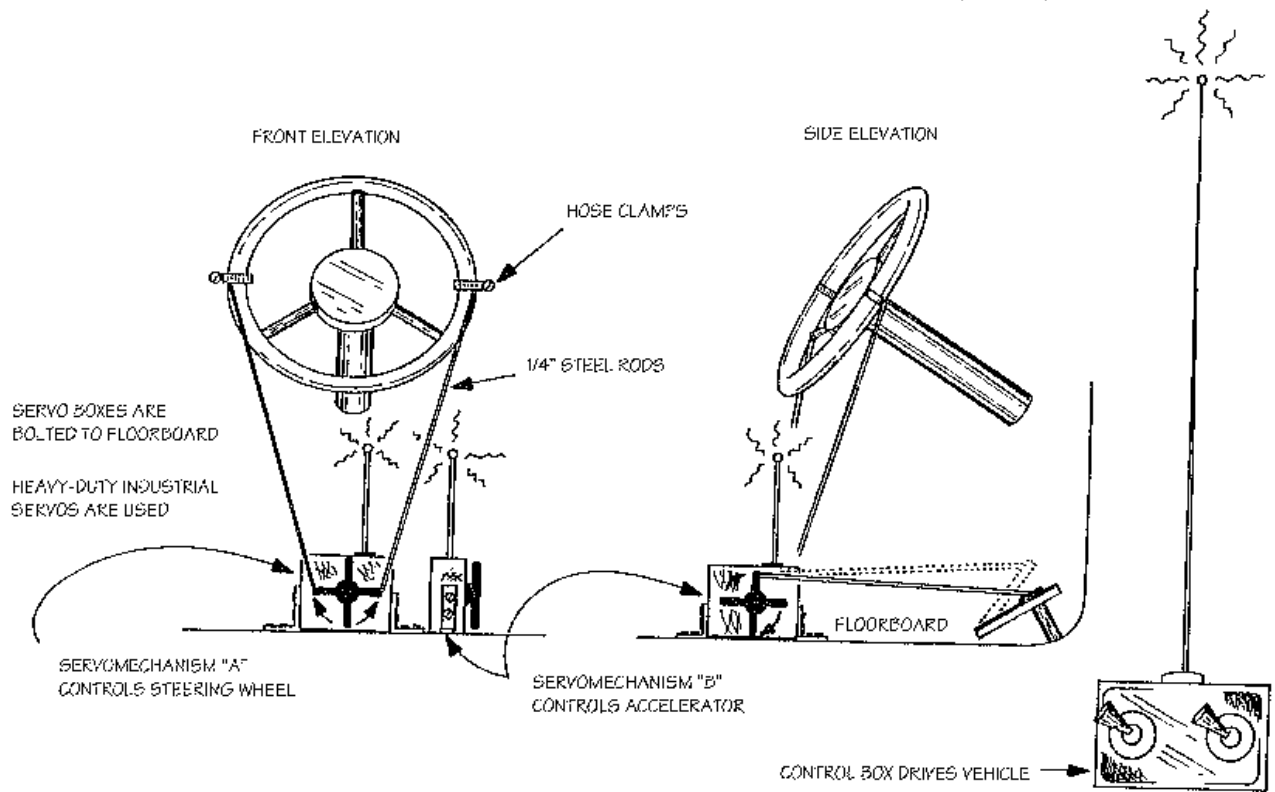

REMOTE CONTROL DRIVING SYSTEM

# IMPROVISED CAR BOMB NO. 34

WORKING:  
 WHEN THE VICTIM SITS ON THE CAR SEAT, THE FOOD  
 SCALE WEIGH PLATE IS DEPRESSED. THIS ACTION  
 CAUSES THE METAL READ NEEDLE TO COMPLETE THE  
 BRIDGE AND CLOSE THE ELECTRICAL CIRCUIT. THE  
 FLASHBULB FIRES AND DETONATES THE GASOLINE

HOW THE DEVICE IS CONSTRUCTED

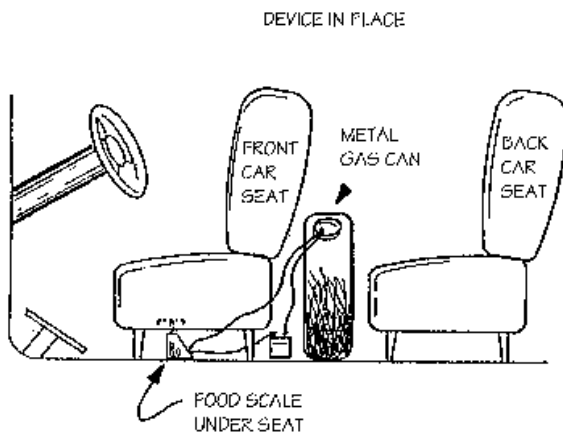

PLASTIC FOOD SCALE  
 WITH METAL NEEDLE

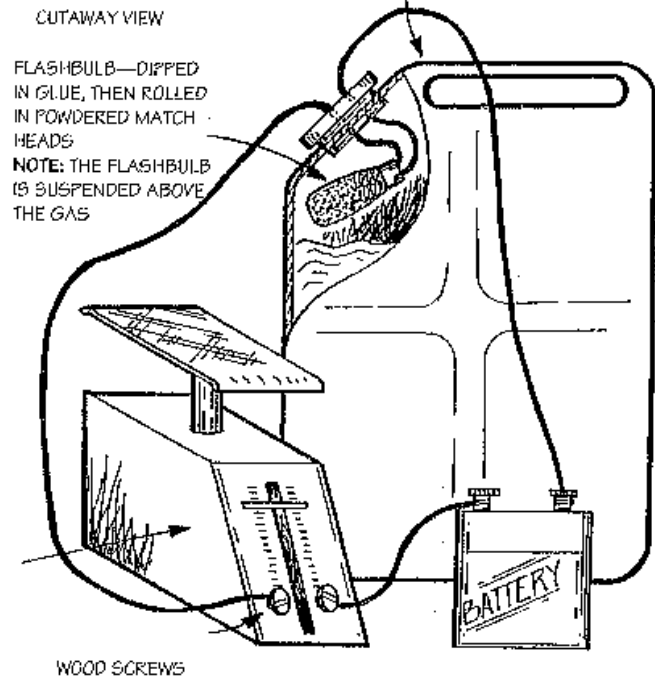

DEADLY AUTO INFERNO

# IMPROVISED CAR BOMB NO. 35

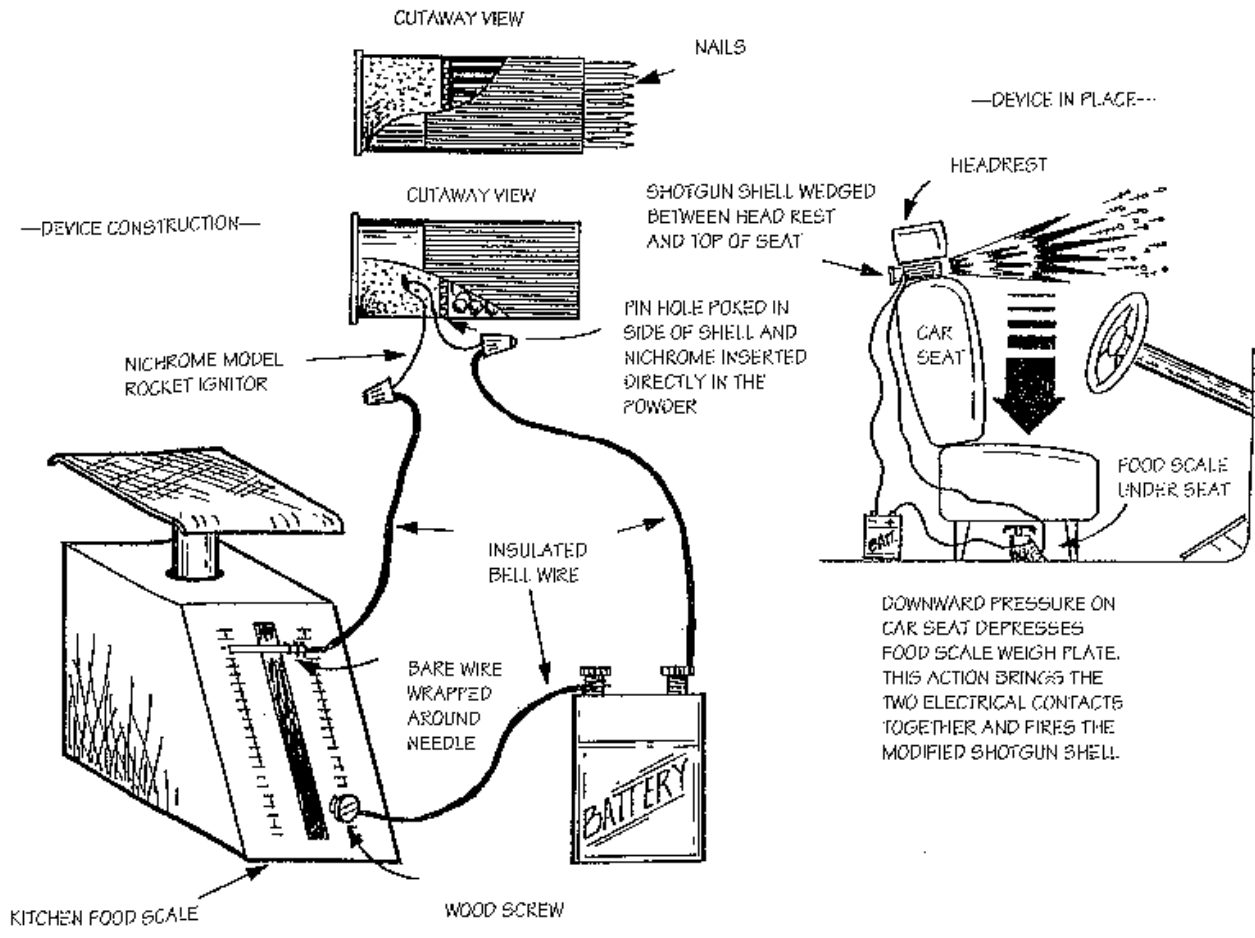

DEADLY CAR SEAT DEVICE

# IMPROVISED CAR BOMB NO. 36

NOTE: GLO-PLUG COULD BE SUBSTITUTED FOR A FLASHBULB OR CUBE, NICHROME WIRE MODEL ROCKET IGNITOR, OR A FLASHLIGHT BULB (GLASS BROKEN AND FILAMENT INTACT)

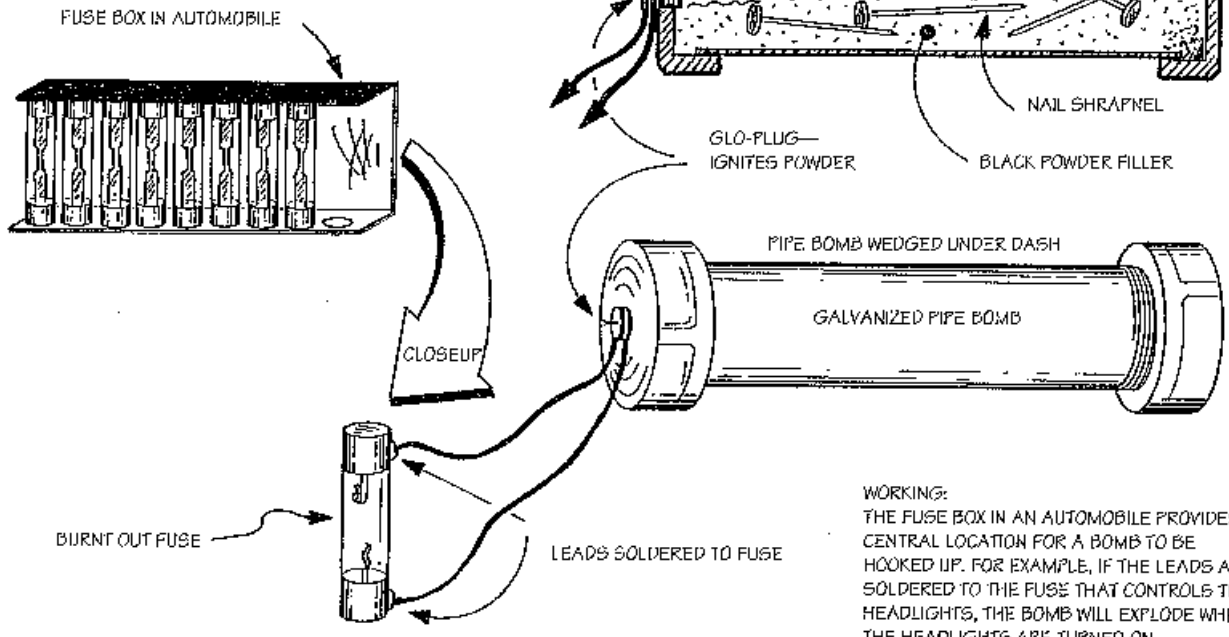

AUTO FUSE BOX DETONATION

# IMPROVISED CAR BOMB NO. 37

WORKING:  
 AS THE AUTOMOBILE MOVES IN EITHER DIRECTION, THE WIRE WINDS AROUND THE AXLE. THIS DRAWS THE ACCELERATOR TO THE FLOOR, WHERE THE VELCRO STRIPS MEET AND LOCK. NORMALLY, THE WIRE WILL SNAP AT THIS POINT. THE ACCELERATOR IS FLOORED AND THE CAR IS MOVING AT MAXIMUM SPEED, MOST LIKELY IN REVERSE

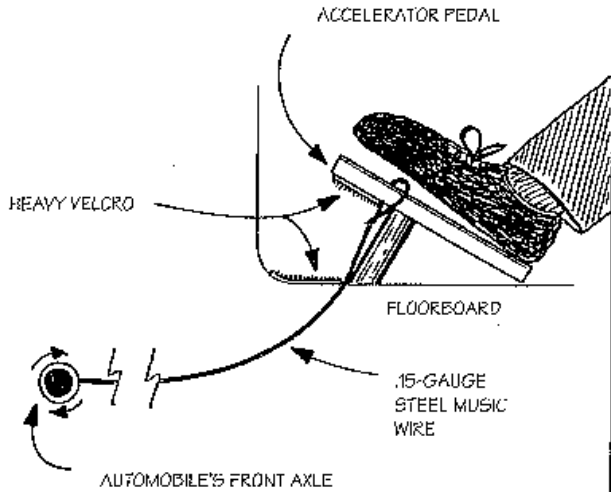

INFINITY ACCELERATOR

—THE DEVICE—

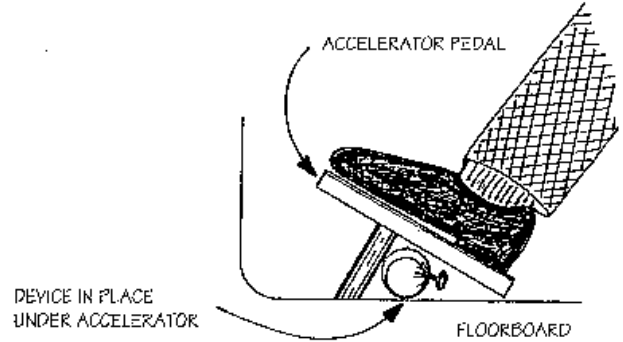
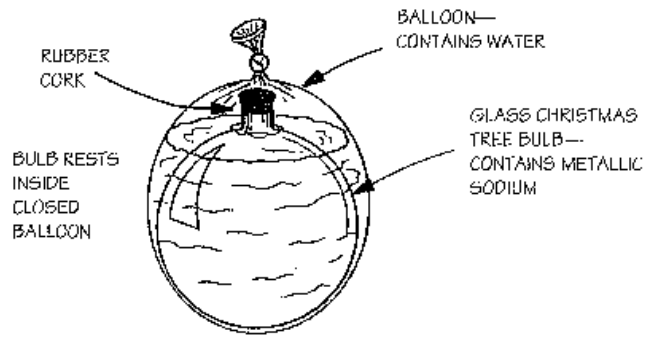

WORKING:  
 DOWNWARD ACCELERATION CRUSHES BULB IN BALLOON. THE CONTENTS MIX AND A FIRE AND EXPLOSION IS CREATED

HYPERGOLIC FIRE STARTER

# IMPROVISED CAR BOMB NO. 38

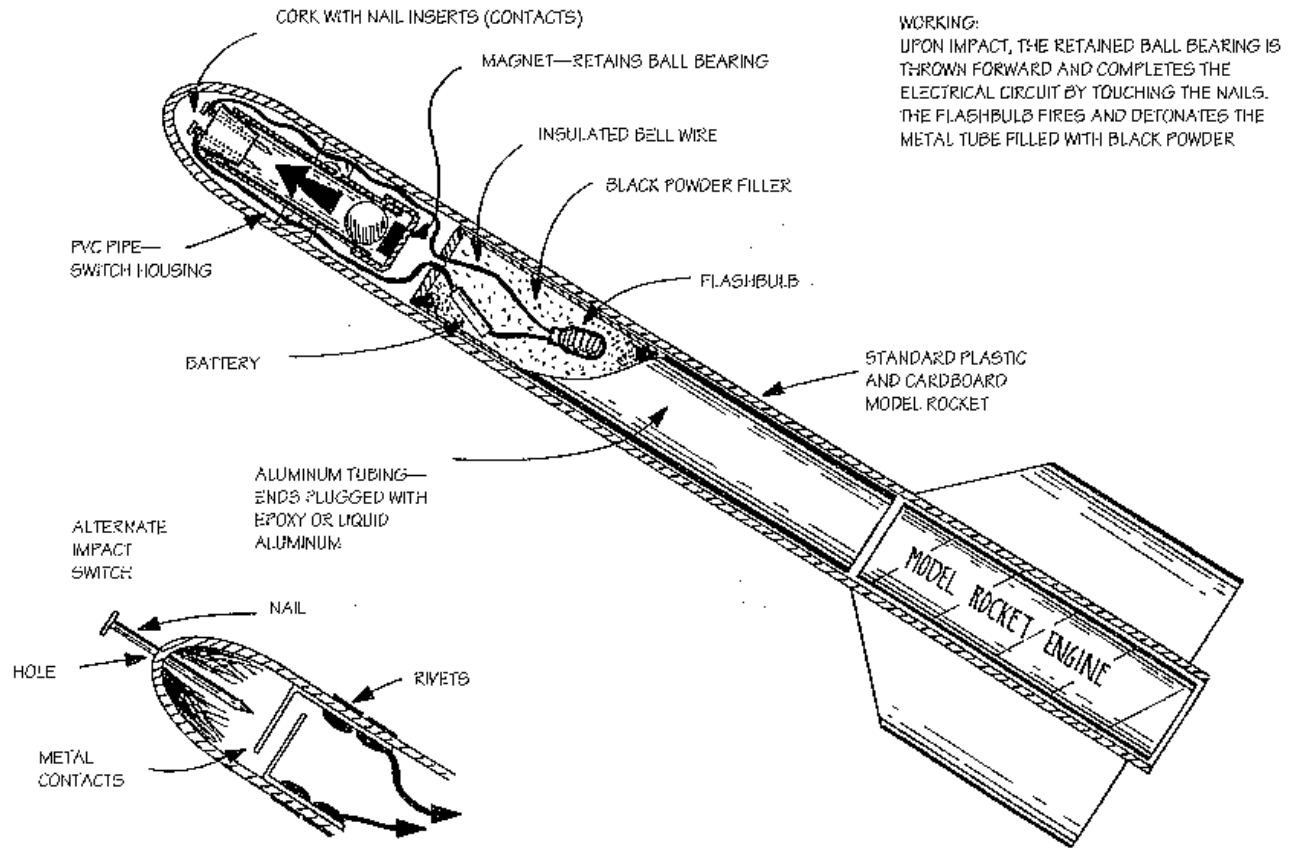

WORKING:  
UPON IMPACT, THE RETAINED BALL BEARING IS THROWN FORWARD AND COMPLETES THE ELECTRICAL CIRCUIT BY TOUCHING THE NAILS. THE FLASHBULB FIRES AND DETONATES THE METAL TUBE FILLED WITH BLACK POWDER

HOMEMADE MISSILE WITH PAYLOAD

# IMPROVISED CAR BOMB NO. 39

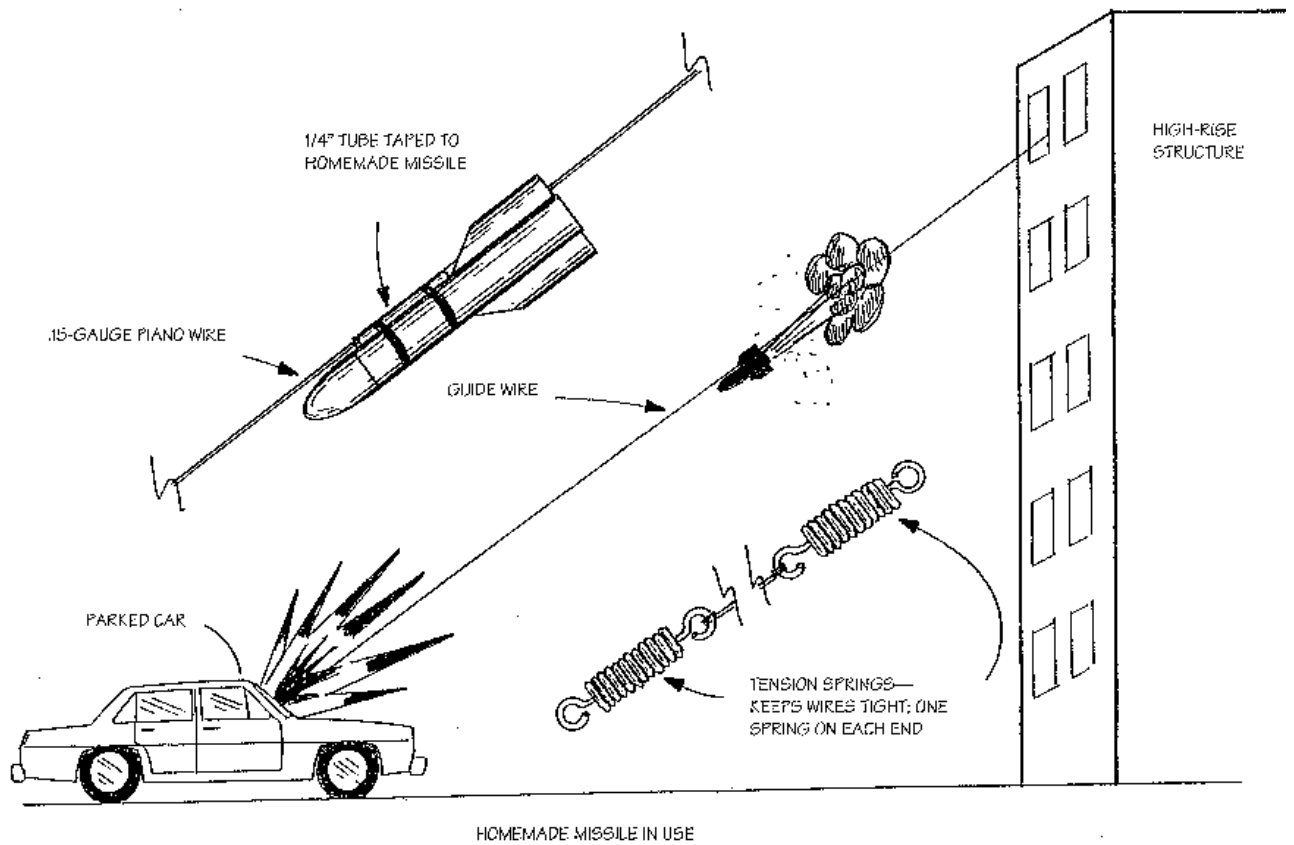

# IMPROVISED CAR BOMB NO. 39 (CONT.)



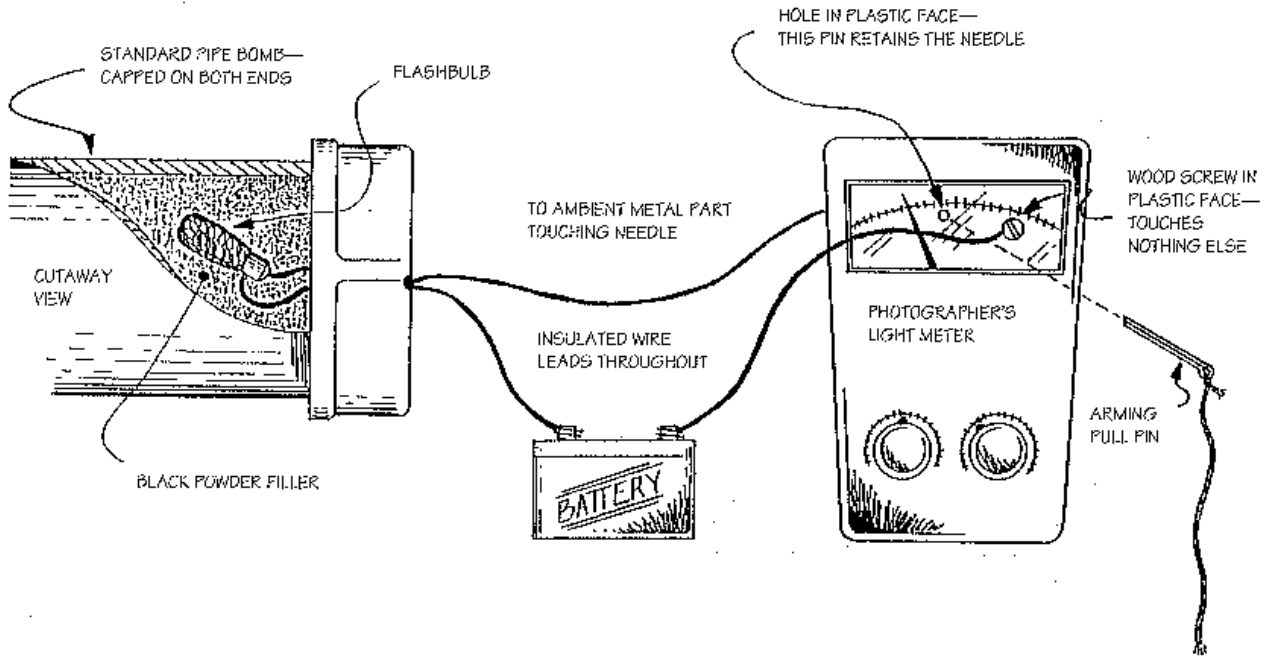

- ENTIRE DEVICE IS ENCLOSED IN AN OPAQUE CARDBOARD BOX, WHICH IS SEALED IN HEAVY MAILING TAPE
- STRING FROM THE ARMING PIN PROTRUDES THROUGH A PIN HOLE IN THE TRUNK
- ONCE THE TRUNK IS CLOSED, STRING IS PULLED AND CUT OFF AT HOLE

LIGHT-SENSITIVE TRUNK BOMB 1

# IMPROVISED CAR BOMB NO. 40

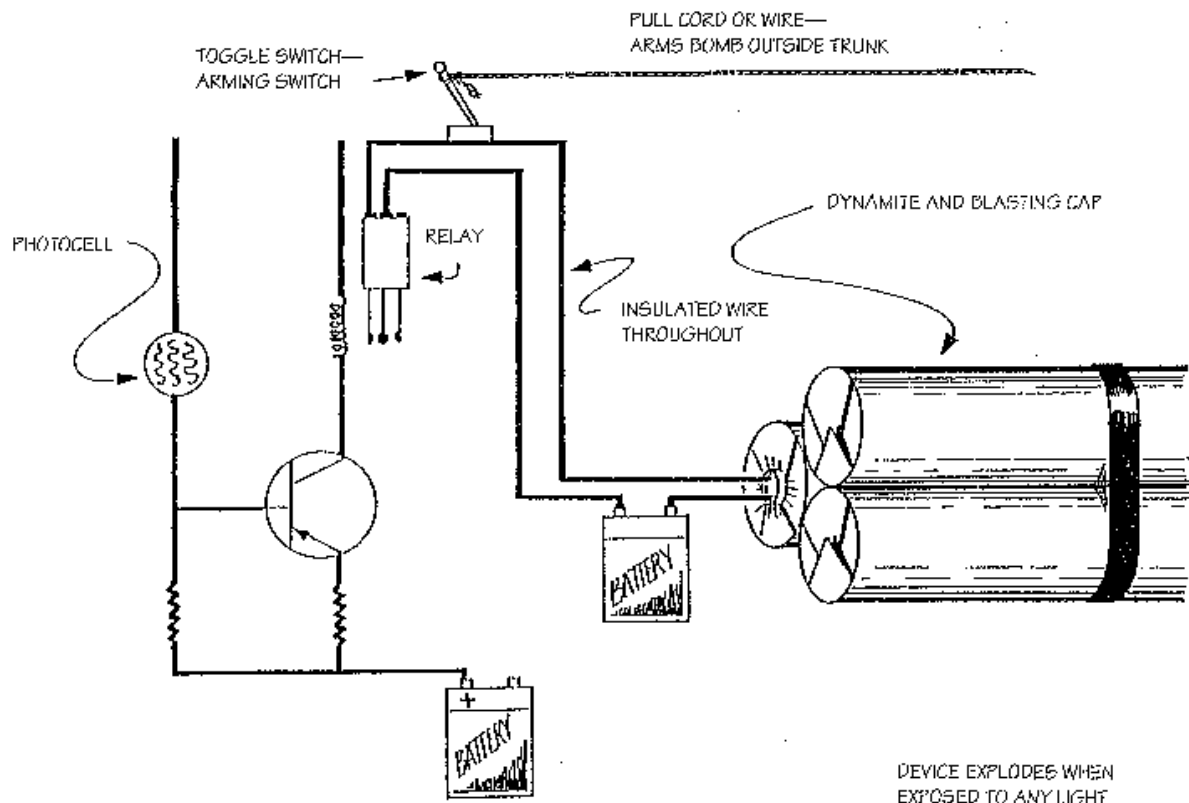

DEVICE EXPLODES WHEN  
EXPOSED TO ANY LIGHT

THE BLASTING CAP AND  
DYNAMITE COULD BE REPLACED  
BY A PIPE BOMB

LIGHT-SENSITIVE TRUNK BOMB 2

# IMPROVISED CAR BOMB NO. 41

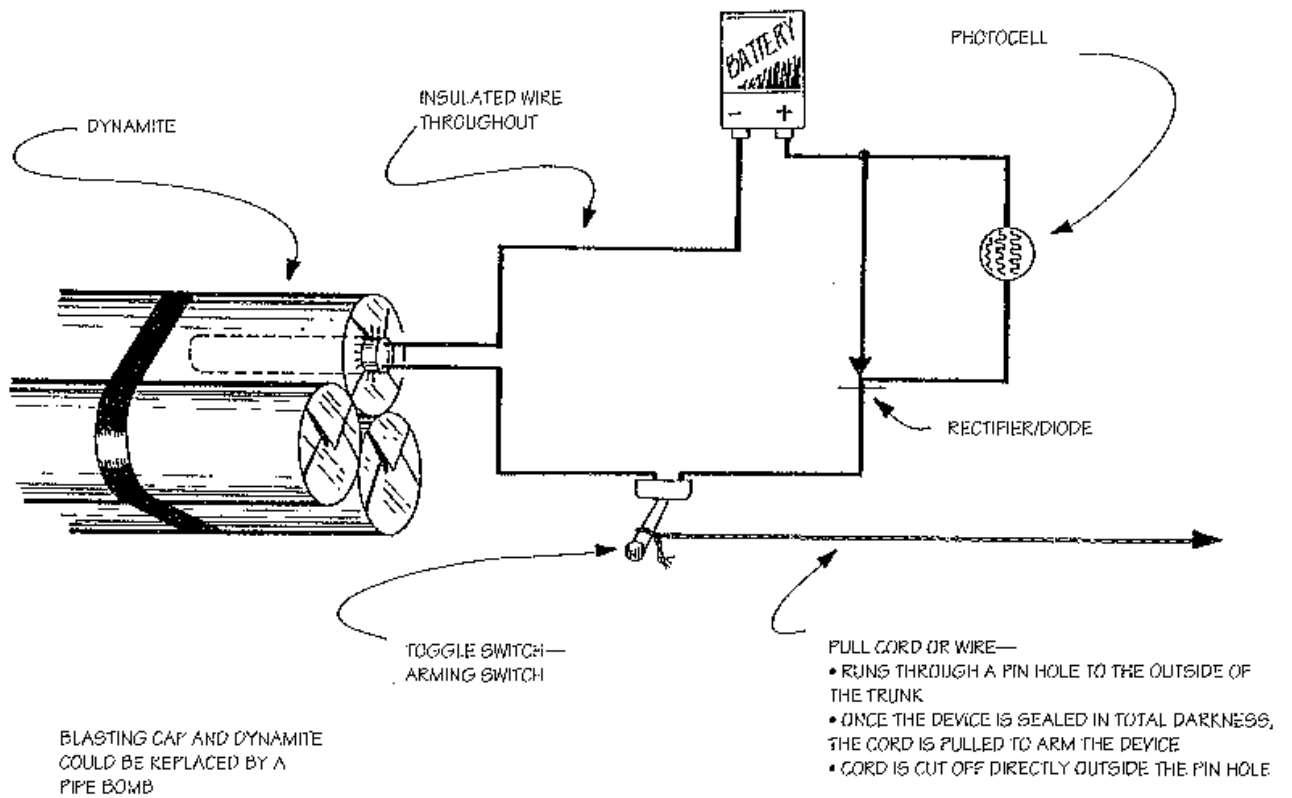

LIGHT-SENSITIVE TRUNK BOMB 3

# IMPROVISED CAR BOMB NO. 42