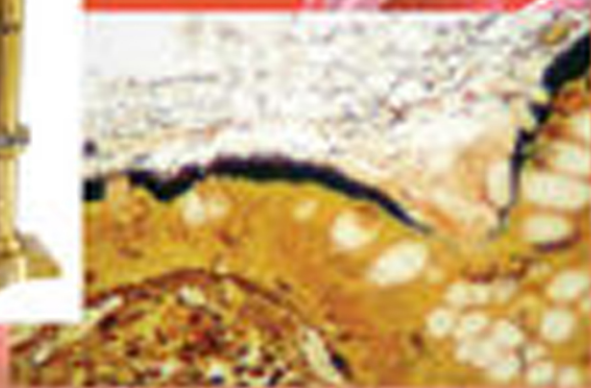


Luis M. de la Maza | Marie T. Pezzlo
Cassiana E. Bittencourt | Ellena M. Peterson

THIRD EDITION

Color Atlas of Medical Bacteriology



THIRD EDITION

Color Atlas of Medical Bacteriology

THIRD EDITION

Color Atlas of Medical Bacteriology

Luis M. de la Maza

Professor, Department of Pathology and Laboratory Medicine
Associate Director, Division of Medical Microbiology
University of California, Irvine School of Medicine
Orange, California

Marie T. Pezzlo

Clinical Microbiology Consultant
Laguna Beach, California

Cassiana E. Bittencourt

Assistant Professor, Department of Pathology and Laboratory Medicine
Director, Division of Medical Microbiology
University of California, Irvine School of Medicine
Orange, California

Ellena M. Peterson

Professor, Department of Pathology and Laboratory Medicine
Associate Director, Division of Medical Microbiology
University of California, Irvine School of Medicine
Orange, California



**ASM
PRESS**

WASHINGTON, DC 20036

WILEY

Copyright © 2020 American Society for Microbiology. All rights reserved.

Copublication by the American Society for Microbiology and John Wiley & Sons, Inc.

No part of this publication may be reproduced, stored in a retrieval system, or transmitted in any form or by any means electronic, mechanical, photocopying, recording, scanning, or otherwise, except as permitted by law. Advice on how to reuse material from this title is available at <http://wiley.com/go/permissions>.

The right of Luis M. de la Maza, Marie T. Pezzlo, Cassiana E. Bittencourt, and Ellena M. Peterson to be identified as the authors of this work has been asserted in accordance with law.

Limit of Liability/Disclaimer of Warranty

While the publisher and author have used their best efforts in preparing this book, they make no representations or warranties with respect to the accuracy or completeness of the contents of this book and specifically disclaim any implied warranties of merchantability or fitness for a particular purpose. No warranty may be created or extended by sales representatives or written sales materials. The publisher is not providing legal, medical, or other professional services. Any reference herein to any specific commercial products, procedures, or services by trade name, trademark, manufacturer, or otherwise does not constitute or imply endorsement, recommendation, or favored status by the American Society for Microbiology (ASM). The views and opinions of the author(s) expressed in this publication do not necessarily state or reflect those of ASM, and they shall not be used to advertise or endorse any product.

Editorial Correspondence

ASM Press, 1752 N Street, NW, Washington, DC 20036-2904, USA

Registered Offices

John Wiley & Sons, Inc., 111 River Street, Hoboken, NJ 07030, USA

For details of our global editorial offices, customer services, and more information about Wiley products, visit us at www.wiley.com.

Wiley also publishes its books in a variety of electronic formats and by print-on-demand. Some content that appears in standard print versions of this book may not be available in other formats.

Library of Congress Cataloging-in-Publication Data

Names: De la Maza, Luis M., author.

Title: Color atlas of medical bacteriology / Luis M. de la Maza, Professor, Department of Pathology and Laboratory Medicine, Associate Director, Division of Medical Microbiology, University of California, Irvine, School of Medicine, Orange, California, Marie T. Pezzlo, Clinical Microbiology Consultant, Laguna Beach, California, Cassiana E. Bittencourt, Assistant Professor, Department of Pathology and Laboratory Medicine, Director, Division of Medical Microbiology, University of California, Irvine, School of Medicine, Orange, California, Ellena M. Peterson, Professor, Department of Pathology and Laboratory Medicine, Associate Director, Division of Medical Microbiology, University of California, Irvine, School of Medicine, Orange, California.

Description: Third edition. | Washington, DC: ASM Press; Hoboken, NJ: Wiley, [2020] | Includes index.

Identifiers: LCCN 2020004350 (print) | LCCN 2020004351 (ebook) | ISBN 9781683670353 (hardback) | ISBN 9781683670360 (adobe pdf) | ISBN 9781683670483 (epub)

Subjects: LCSH: Medical bacteriology--Atlases.

Classification: LCC QR46 .C773 2020 (print) | LCC QR46 (ebook) | DDC 616.9/201--dc23

LC record available at <https://lcn.loc.gov/2020004350>

LC ebook record available at <https://lcn.loc.gov/2020004351>

Cover images: Conceptual image of DNA © Stocktrek Images / Getty Images. Inset images: left (*Micrococcus luteus* on blood agar, see chapter 1) courtesy of Luis M. de la Maza; middle (old-fashioned microscope) © Birgit Reitz-Hofmann / Shutterstock; right (*Brachyspira*, Warthin-Starry silver stain, see chapter 35) courtesy of Dominick Cavuoti, University of Texas Southwestern Medical Center. Author images: de la Maza, courtesy Shelley P. Detweiler; Pezzlo, courtesy Madeline Anderson; Bittencourt and Peterson, courtesy University of California, Irvine

Cover design: Wiley

Printed in the United States of America

10 9 8 7 6 5 4 3 2 1

Contents

Preface ix

Acknowledgments xi

Technical Note xi

About the Authors xiii

- 1 *Staphylococcus, Micrococcus, and Other
Catalase-Positive Cocci* 1
Ellena M. Peterson
- 2 *Streptococcus* 11
Ellena M. Peterson
- 3 *Enterococcus* 24
Ellena M. Peterson
- 4 *Aerococcus, Abiotrophia, and Other Miscellaneous
Gram-Positive Cocci That Grow Aerobically* 30
Marie T. Pezzlo
- 5 *Coryneform Gram-Positive Bacilli* 36
Marie T. Pezzlo
- 6 *Listeria and Erysipelothrix* 48
Luis M. de la Maza
- 7 *Bacillus* 54
Marie T. Pezzlo
- 8 *Nocardia, Rhodococcus, Actinomadura, Streptomyces,
Gordonia, and Other Aerobic Actinomycetes* 62
Luis M. de la Maza
- 9 *Mycobacterium* 70
Luis M. de la Maza
- 10 *Introduction to Enterobacterales* 91
Marie T. Pezzlo

- 11 *Escherichia, Shigella, and Salmonella* 103
Marie T. Pezzlo
- 12 *Klebsiella, Enterobacter, Citrobacter, Cronobacter, Serratia, Plesiomonas, and Selected Other Enterobacterales* 113
Marie T. Pezzlo
- 13 *Yersinia* 129
Marie T. Pezzlo
- 14 *Vibrionaceae* 134
Marie T. Pezzlo
- 15 *Aeromonas* 141
Marie T. Pezzlo
- 16 *Pseudomonas* 145
Marie T. Pezzlo
- 17 *Burkholderia, Stenotrophomonas, Ralstonia, Cupriavidus, Pandoraea, Brevundimonas, Comamonas, Delftia, and Acidovorax* 150
Marie T. Pezzlo
- 18 *Acinetobacter, Chryseobacterium, Moraxella, Methylobacterium, and Other Nonfermentative Gram-Negative Bacilli* 157
Marie T. Pezzlo
- 19 *Actinobacillus, Aggregatibacter, Capnocytophaga, Eikenella, Kingella, Pasteurella, and Other Fastidious or Rarely Encountered Gram-Negative Bacilli* 168
Marie T. Pezzlo
- 20 *Legionella* 180
Ellena M. Peterson
- 21 *Neisseria* 184
Ellena M. Peterson
- 22 *Haemophilus* 191
Ellena M. Peterson
- 23 *Bordetella and Related Genera* 197
Ellena M. Peterson
- 24 *Brucella* 203
Luis M. de la Maza
- 25 *Bartonella* 207
Luis M. de la Maza
- 26 *Francisella* 210
Luis M. de la Maza

- 27 Introduction to Anaerobic Bacteria 213
Luis M. de la Maza
- 28 *Clostridium* and *Clostridioides* 223
Luis M. de la Maza
- 29 *Peptostreptococcus*, *Finegoldia*, *Anaerococcus*, *Peptoniphilus*,
Cutibacterium, *Lactobacillus*, *Actinomyces*, and Other
Non-Spore-Forming, Anaerobic Gram-Positive Bacteria 237
Luis M. de la Maza
- 30 *Bacteroides*, *Porphyromonas*, *Prevotella*, *Fusobacterium*, and
Other Anaerobic Gram-Negative Bacteria 252
Luis M. de la Maza
- 31 *Campylobacter* and *Arcobacter* 261
Luis M. de la Maza
- 32 *Helicobacter* 267
Luis M. de la Maza
- 33 *Chlamydia* 272
Ellena M. Peterson
- 34 *Mycoplasma* and *Ureaplasma* 277
Luis M. de la Maza
- 35 *Leptospira*, *Borrelia*, *Treponema*, and *Brachyspira* 281
Luis M. de la Maza
- 36 *Rickettsia*, *Orientia*, *Ehrlichia*, *Anaplasma*, and *Coxiella* 290
Luis M. de la Maza
- 37 *Tropheryma whipplei* 297
Luis M. de la Maza
- 38 Antimicrobial Susceptibility Testing 299
Ellena M. Peterson
- 39 Molecular Diagnosis of Bacterial Infections 307
Luis M. de la Maza
- 40 Total Laboratory Automation 330
Cassiana E. Bittencourt
- 41 Stains, Media, Reagents, and Histopathology 338
Cassiana E. Bittencourt and Marie T. Pezzlo
- 42 Fast Facts: Bacteria 367
Cassiana E. Bittencourt

Preface

At the dawn of the third millennium, when the names of Watson and Crick are more familiar to students than Koch and Pasteur, when the acronyms NAAT and MALDI-TOF are replacing hands-on identification methods, who needs an atlas of bacteriology?

Traditionally, diagnostic bacteriology has been in great part dependent on the subjective interpretation of a Gram stain or growth on an agar plate. While there are several excellent textbooks on the subject, they usually are written descriptions of microorganisms with few images. In part, we were motivated to publish the first edition of this atlas by the challenge to find illustrations for our own lectures and laboratory presentations. However, medical bacteriology is dynamic, with frequent changes especially in taxonomy and methodology. Therefore we accepted the challenge of an update.

In this third edition of *Color Atlas of Medical Bacteriology* we have included new illustrations of typical Gram stains, colony morphologies, and biochemical reactions and have added a large section on the histopathology of some organisms. We have also included a new chapter, addressing total laboratory automation, and the Fast Facts tables in chapter 42 which summarize critical details of the bacteria discussed in this third edition. “Total laboratory automation” implementation is so far limited to large-volume laboratories, but some automation components are already in use in medium-sized facilities. The purpose of the Fast Facts chapter is to help laboratorians, working on a clinical specimen, who may need a quick reminder of the characteristics of a particular bacterial isolate, and all students looking for a quick “refresher” in preparation for an exam.

Each book chapter has a brief introduction to provide context for the illustrations. For in-depth background of individual organisms, the reader should consult one of the many excellent textbooks and manuals available. This third edition was structured

with reference to a number of sources, listed below, but in particular to the *Manual of Clinical Microbiology*, 12th edition (MCM12), from ASM Press. However, we are responsible for any errors that appear in this atlas. The number of images that we include of a particular organism does not necessarily correlate with the frequency of its isolation or its clinical relevance. Certain bacteria have variable, distinctive, or unique pictorial characteristics, and we have tried to provide a representative sampling of these. We hope you will find this atlas a useful reference tool.

The implementation of genomics and proteomics is revolutionizing diagnostic clinical microbiology. However, like Janus, all revolutions have two faces. On the positive side, these new approaches have already helped the clinical laboratory to significantly improve the sensitivity and specificity of the identification of many microorganisms. These methodologies have also expedited organism identification, thus improving patient management. Significant challenges are still ahead before we can take full advantage of these new technologies. The extraordinary complexity of the human microbiome is going to require the deployment of massive resources before we can collect, classify, and interpret the data. However, before we get there, we are going to have to learn how to deal with the second face of Janus. Although changes in taxonomy may have very positive effects on medical practice by guiding more specific treatments, they also result in practical problems for the microbiology laboratory on how to incorporate these changes into their practice while maintaining clinician satisfaction and, at the same time, preventing potential negative outcomes. There is an urgent need to establish clear guidelines for defining new families, genera, and species of microorganisms. These guidelines should be written by a group of individuals who represent various areas of expertise including taxonomy, biology, and health sciences.

With the increasing use of genomics and proteomics, the remarkable forms, shapes, and colors of bacteria in the laboratory are rapidly being replaced by signals only measurable by instruments. The time is very near when we will be showing our grandchildren many of the images in this atlas that have become a distant memory. In the meantime, let us enjoy the beauty of the colorful bacterial world.

References

- Carroll KC, Pfaller MA, Landry ML, McAdam AJ, Patel R, Richter SS, Warnock DW (ed). 2019. *Manual of Clinical Microbiology*, 12th ed. ASM Press, Washington, DC.
- Doern CD. 2018. *Pocket Guide to Clinical Microbiology*, 4th ed. ASM Press, Washington, DC.
- Jousimies-Somer HR, Summanen P, Citron DM, Baron EJ, Wexler HM, Finegold SM. 2002. *Wadsworth-KTL Anaerobic Bacteriology Manual*, 6th ed. Star Publishing Co, Inc, Redwood City, CA.
- Mahon CR, Lehman DC. 2019. *Textbook of Diagnostic Microbiology*, 6th ed. WB Saunders Co, Philadelphia, PA.
- Milner DA. 2019. *Diagnostic Pathology: Infectious Diseases*, 2nd ed. Elsevier, Philadelphia, PA.
- Murray PR, Rosenthal KS, Pfaller MA. 2016. *Medical Microbiology*, 8th ed. Elsevier, Philadelphia, PA.
- Procop GW, Church DL, Hall GS, Janda WM, Koneman EW, Schreckenberger PC, Woods GL. 2017. *Koneman's Color Atlas and Textbook of Diagnostic Microbiology*, 7th ed. Wolters Kluwer Health, Lippincott Williams & Wilkins, Philadelphia, PA.
- Tille PM. 2017. *Bailey and Scott's Diagnostic Microbiology*, 14th ed. Elsevier, Philadelphia, PA.
- Walsh TJ, Hayden RT, Larone DH. 2018. *Larone's Medically Important Fungi: A Guide to Identification*, 6th ed. ASM Press, Washington, DC.

Acknowledgments

We would like to thank many individuals who have made this book possible. First and foremost, we thank all the staff in the Division of Medical Microbiology at the University of California, Irvine Medical Center. We also want to thank our present and past colleagues at the Orange County Health Department and in particular Douglas Moore, Paul Hannah, Douglas Schan, and Tamra Townsen. Their help with the first edition of this atlas covering highly pathogenic organisms was invaluable. We also would like to acknowledge the contributions of Alan G. Barbour, Philippe Brouqui, J. Stephen Dumler, Ted Hackstadt, Barbara McKee, James Miller,

and Christopher D. Paddock, who provided key images and specimens and made our work much easier. We are grateful for Dr. Dominick Cavuoti at UT Southwestern Medical Center for his assistance and significant contributions to the histopathological images in this edition. Additionally, we would like to thank AdvanDX, Inc., Anaerobe Systems, APAS Independence, BD Diagnostic Systems, bioMérieux, Inc., COPAN Diagnostics, Dade Behring Inc., EY Laboratories, Hardy Diagnostics, Quidel, Thermo Scientific Remel Products, Inc., and Roche Diagnostics Systems for contributing various organisms, media, reagents, materials, and photographs.

Technical Note

The microscopic pictures were taken with a Zeiss Universal microscope (Carl Zeiss, Inc., West Germany) equipped with Zeiss and Olympus (Olympus Optical Corp., Ltd., Japan) lenses. The majority of histopathological images were obtained either with a Nikon Eclipse Ci microscope, Nikon lenses, and Nikon eyepieces CFI 10x/22 equipped with a digital Nikon DS-Fi1 (Nikon Corporation, Japan) camera or with a Nikon Eclipse 50i microscope, Nikon lenses, and Nikon eyepieces CFI 10x/22 equipped with a digital Nikon Coolpix 4500 camera. The final magnification of the Gram and acid-fast stains is $\times 1,200$.

Most of the macroscopic images were captured with a Contax RTS camera with a Carl Zeiss S-Planar 60 mm $f/2.8$ lens and a Nikon EL camera with a Micro-Nikkor 55 mm $f/3.5$ lens. An Olympus SP-800UZ 14MP digital camera with an ED lens 30 \times wide optical 4.9–147 mm 1:2.8–5.6 was used for a few images.

Provia 100F and 400F Professional Fujichrome film (Fuji Photo Film Co., Ltd., Tokyo, Japan) and Kodachrome 25 Professional film (Eastman Kodak Co., Rochester, NY) were used with the analog equipment.

About the Authors

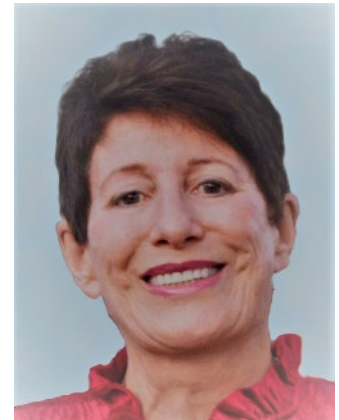
Luis M. de la Maza

A native of Spain, Luis de la Maza obtained his MD degree from the University of Madrid and his PhD from the University of Minnesota. After completing his residency training program in Pathology and Laboratory Medicine in Boston and Minnesota, he spent four years at NIH characterizing the molecular structure and biology of adeno-associated virus. In 1979 he became the Medical Director of the Division of Medical Microbiology at the University of California, Irvine School of Medicine, where he is also the Medical Director of the Clinical Laboratory Scientist training program. His research is focused on the formulation of a *Chlamydia trachomatis* vaccine.



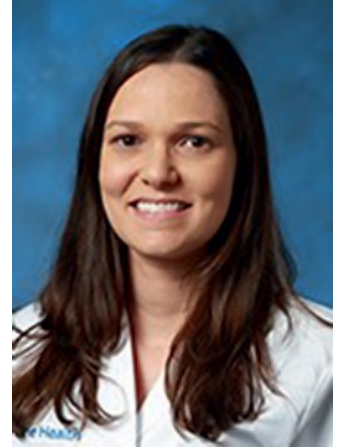
Marie T. Pezzlo

Marie Pezzlo received her Bachelor and Master of Science degrees and medical technologist certification at the University of Connecticut and St. Joseph College. Her passion for clinical microbiology began while working at Hartford Hospital under the directorship of Dr. Raymond Bartlett. Eight years later she became the Senior Supervisor of the Medical Microbiology Division at the University of California, Irvine Medical Center. Her research interest has been focused on rapid detection of microorganisms, especially in urinary tract infections. Throughout her career she has been an active member of the American Society for Microbiology, volunteering in many activities of the Society.



Cassiana E. Bittencourt

A native of Brazil, Cassiana Bittencourt obtained her MD degree from the Metropolitan University of Santos. She completed her pathology residency at University of South Florida and a fellowship in microbiology at University of Texas Southwestern Medical Center. She is certified by the American Board of Pathology in Anatomic and Clinical Pathology as well as Medical Microbiology. In 2016, she joined the Department of Pathology at the University of California, Irvine School of Medicine as Medical Director of the Division of Medical Microbiology. Her current interests include infectious disease histology, application of non-culture-based methods, and resident education.



Ellena M. Peterson

Ellena Peterson received her undergraduate degree from the University of San Francisco and her PhD in Microbiology and Immunology from Georgetown University. In 1978 she joined the Department of Pathology at the University of California, Irvine School of Medicine. During her tenure she served as the Associate Dean of Admissions for the School of Medicine and as the Associate Director of the Clinical Microbiology Laboratory, and presently she is the Program Director of the Clinical Laboratory Scientist Program. Her research has been focused on the pathogenicity of *Chlamydia* spp.



Staphylococcus, Micrococcus, and Other Catalase-Positive Cocci

1

Members of the genera *Staphylococcus*, *Micrococcus*, *Kocuria*, and *Kytococcus* are characterized as being catalase-positive, Gram-positive cocci that occur in pairs and clusters. These organisms commonly colonize the surfaces of skin and mucosal membranes of mammals and birds. Members of the genus *Staphylococcus* are important human pathogens, whereas the other genera in this chapter play a lesser role in human infections and thus are discussed separately.

Traditionally, members of the genus *Staphylococcus* have been divided into those that are coagulase positive, i.e., *Staphylococcus aureus*, and those that are referred to as coagulase-negative staphylococci (CoNS), i.e., all others, based on their ability to clot rabbit plasma. The species of *Staphylococcus* most frequently associated with human infections is *S. aureus*, which is a major cause of morbidity and mortality. *S. aureus* can produce disease mediated by toxins or by direct invasion and destruction of tissues. *S. aureus* infections range from superficial skin infections to fatal systemic infections that can occur when the integrity of the skin is damaged, thus giving this pathogen access to sterile sites. Among the more common *S. aureus* infections are boils, folliculitis, cellulitis, and impetigo. Immunocompromised hosts are at particular risk of infection. Systemic infections include septicemia, which can result in the seeding of distant sites, producing osteomyelitis, pneumonia, and endocarditis. Toxigenic strains of *S. aureus* are capable of producing bullous impetigo, scalded-skin syndrome, and toxic shock syndrome. *S. aureus* is also a well-known

contributor to food poisoning due to the elaboration of enterotoxins in foods such as potato salad, ice cream, and custards. Intense vomiting and diarrhea usually occur within 2 to 8 h after ingestion of food containing the toxin.

CoNS, in particular *Staphylococcus epidermidis*, *Staphylococcus saprophyticus*, *Staphylococcus haemolyticus*, *Staphylococcus lugdunensis*, and *Staphylococcus schleiferi*, play a role in human infection. In particular, *S. epidermidis* is recognized as a leading cause of health care-related infections, with immunocompromised hosts being at increased risk. Because CoNS are members of the normal skin and mucosal membrane microbiota, they are frequently considered a contaminant when isolated from clinical specimens and therefore may be overlooked as a cause of infection. This is compounded by the fact that their clinical presentation is subacute, unlike that of *S. aureus*. An important virulence property of CoNS is their ability to form a biofilm on the surface of indwelling or implanted devices, making them frequent agents of intravascular infections. *S. epidermidis* has also been implicated as a cause of endocarditis and is associated with right-side endocarditis in intravenous-drug users. *S. saprophyticus* is a leading cause of noncomplicated urinary tract infections in young, sexually active females, second only to *Escherichia coli* in this patient population. Of the more recently described CoNS human pathogens, *S. lugdunensis* and *S. schleiferi* have been implicated in serious infections, including endocarditis, septicemia, arthritis, and joint infections. *S. lugdunensis*, which more frequently colonizes skin and infects tissue

(causing, e.g., boils and abscesses) below the waist, at times can behave more like *S. aureus* than CoNS. This organism has been associated with aggressive infections, such as endocarditis, that have a high mortality rate; therefore, rapid recognition of this species is important for initiation of appropriate antimicrobial therapy. While other species of CoNS have been implicated in a variety of infections, they occur with less frequency.

An increasing problem with *S. aureus* and CoNS is resistance to antimicrobial agents, in particular methicillin. In the majority of methicillin-resistant *S. aureus* (MRSA) strains, this is due to production of an altered penicillin-binding protein, mainly PBP2a or PBP2c, encoded by the *mecA* or *mecC* gene, respectively, which is carried on a mobile genetic unit referred to as SCC*mec*. Overproduction of β -lactamase accounts for a smaller percentage of MRSA or MR-CoNS strains. In recent years, *S. aureus* strains with decreased susceptibility to vancomycin have been identified. These strains are referred to as vancomycin-intermediate *S. aureus* (VISA), as vancomycin-resistant *S. aureus* (VRSA) when the vancomycin MIC is ≥ 16 $\mu\text{g/ml}$, or, when their susceptibility to the glycopeptide class of antimicrobials as a whole is being addressed, as glycopeptide-intermediate *S. aureus* (GISA). Although only a few of these strains have been isolated, they pose a potential threat to effective treatment of serious *S. aureus* infections.

Testing for MRSA can be difficult due to heteroresistance, in which the resistance is expressed to a different extent among subpopulations. In susceptibility tests performed by disk diffusion or tests to determine a MIC, cefoxitin has been shown to have greater sensitivity for detecting MRSA than oxacillin, also a common antibiotic used to test for MRSA. Molecular assays to directly detect the *mecA* gene, as well as rapid assay formats employing monoclonal antibodies to the altered PBP2a protein, have been used to circumvent the problems of *in vitro* susceptibility testing for MRSA. In addition, due to the importance of rapidly identifying cultures positive for *S. aureus*, in particular MRSA, primers and probes for *S. aureus* and MRSA have been incorporated into a number of nucleic acid-based panels and individual nucleic acid amplification assays. Depending on the assay, these tests can be performed directly from clinical specimens or on blood cultures positive for Gram-positive cocci in pairs and clusters. In addition, screening for MRSA from nares cultures can be done by nucleic acid amplification or use of selective chromogenic agars.

Identifying VISA strains by standard susceptibility methods remains a challenge; however, VRSA strains with higher vancomycin MICs can be identified using broth dilution, select automated systems, and screening agar incorporating 6 $\mu\text{g/ml}$ of vancomycin.

Upon incubation in air at 35°C for 24 to 48 h, staphylococci grow rapidly on a variety of media, with colonies that range from 1 to 3 mm in diameter. On blood agar, staphylococci produce white to cream, opaque colonies. *S. aureus* colonies typically are cream in color but occasionally have a yellow or golden pigment, a phenotypic characteristic that led to the species name. *S. aureus* can be beta-hemolytic, and it is not uncommon to see both large and small colonies in the same culture, a phenotypic characteristic shared by several heteroresistant MRSA strains. CoNS, especially *S. epidermidis*, produce white colonies; however, other CoNS strains and species can have colonies with a slight cream pigment. In general, CoNS strains are nonhemolytic; however, some produce a small zone of beta-hemolysis on blood agar.

Since *S. aureus* is frequently isolated in mixed cultures, selective and differential media are used to facilitate the detection of these organisms in clinical material, particularly in nasal swabs, which are used to screen for carriage of this bacterium. Mannitol salt agar is an example of this, where the high concentration of salt (7.5%) inhibits many other organisms. Mannitol, along with the phenol red indicator in the medium, facilitates the discrimination of *S. aureus*, which can ferment mannitol, from most CoNS. However, since other organisms can grow on this medium and strains of CoNS can also ferment mannitol, additional testing is required. As mentioned above, chromogenic media selective and differential for MRSA are more commonly used for screening nasal cultures.

In addition to their distinctive Gram stain morphology (Gram-positive cocci in pairs and clusters), a common characteristic of these organisms is that they are catalase positive. The coagulase test, which measures the ability to clot plasma by converting fibrinogen to fibrin, is useful in distinguishing *S. aureus* from other bacteria that appear similar. A suspension of the organism to be identified is inoculated into rabbit plasma containing EDTA and incubated at 35°C for 4 h. The tube is tilted gently, and the presence or absence of clot formation is noted. If the test is negative at 4 h, the suspension is incubated for up to 24 h. The 4-h reading is important because some strains

produce fibrinolysin, which can dissolve a clot upon prolonged incubation, causing a false-negative result. Some strains of MRSA produce a very weak coagulase reaction, resulting in a negative reading. Bound coagulase (clumping factor) can be detected by a slide agglutination test, in which a suspension of the organism is emulsified on a slide with a drop of rabbit plasma. If bound coagulase is present, the organisms agglutinate. For correct interpretation of this test, a control in which saline is used instead of plasma is needed to check for autoagglutination. Of the CoNS, *S. lugdunensis* and *S. schleiferi* can also test positive for bound coagulase but can be differentiated from *S. aureus* by a negative tube coagulation test. Alternatively, commercially available tests can be used that are based on latex particles that have been coated with plasma, immunoglobulin, or (in some versions of this test) antibodies to the more common polysaccharide antigens. The plasma detects bound clumping factor, while the immunoglobulin binds protein A and the antibody to the polysaccharide antigens binds serotype antigens present on the surface of *S. aureus*. Some strains of MRSA, however, may be negative by this method because of low levels of bound coagulase and protein A, and false-positive reactions can occur due to the presence of the polysaccharide antigens present on some CoNS isolates.

Strains of *S. aureus* that produce a weak coagulase reaction can be further tested by the DNase test or a thermostable-endonuclease test. *S. aureus* and *S. schleiferi* possess enzymes that can degrade DNA, a DNase and a thermostable endonuclease. Both tests use the same basic medium containing agar that incorporates DNA and the metachromatic dye toluidine blue O. A heavy suspension of organisms is spotted onto the plate; after 24 h of incubation at 35°C, a pink haze appears around the colony, in contrast to the azure blue of the medium. In tests for the thermostable endonuclease, a suspension of the organism is boiled before being placed on the DNA plate.

CoNS can be identified to the species level based on their susceptibility profiles in response to selected agents, most notably novobiocin, as well as key biochemicals. A variety of commercial systems combine several biochemical tests to allow differentiation among the CoNS. While most of the CoNS of clinical importance are novobiocin susceptible, *S. saprophyticus* is novobiocin

resistant. Other tests that can be used to differentiate among the species are those for phosphatase activity, production of acetoin, polymyxin susceptibility, pyrrolidonyl arylamidase activity, and acid production from carbohydrates.

While biochemical tests are still commonly used to identify strains of *Staphylococcus* to the species level, matrix-assisted laser desorption ionization-time of flight (MALDI-TOF) mass spectrometry is rapidly replacing traditional biochemical algorithms.

Several species that once were in the genus *Micrococcus* and that have been reported to play a role in human infections have been reclassified into the genera *Kocuria* and *Kytococcus*. Despite the reclassification, collectively these organisms are often referred to as micrococci. Members of the micrococci have a higher G+C content than the staphylococci. They are also common inhabitants of the skin but have a fairly low pathogenic potential. However, infections with these organisms have occurred in immunocompromised hosts. *Micrococcus luteus* and related organisms have been implicated in a variety of infections, including meningitis, central nervous system shunt infections, endocarditis, and septic arthritis.

Micrococci, in addition to forming pairs and clusters, can appear as tetrads. Like the staphylococci, they can be easily grown in the laboratory and can be recovered from a variety of media. However, in comparison to staphylococci, they are slower growing, with smaller colonies present after 24 h of incubation at 35°C. In addition, depending on the species, the colony color can range from cream to yellow (*M. luteus*) or rose red. As with CoNS, a variety of commercial systems that incorporate several tests, including urease, acid production from carbohydrates, esculin, and gelatin, have been employed to aid in the differentiation of this group. Bacitracin, lysostaphin, and furazolidone have been used to aid in differentiating staphylococci from micrococci. In general, staphylococci are resistant to bacitracin (0.04-U disk), in contrast to micrococci, which are susceptible, while the opposite is found with furazolidone (100-µg disk) and lysostaphin (200-µg disk), where micrococci are resistant. MALDI-TOF has aided in the identification of micrococci, and with more strains being added to present databases, this method is rapidly becoming the method of choice for identification of micrococci.

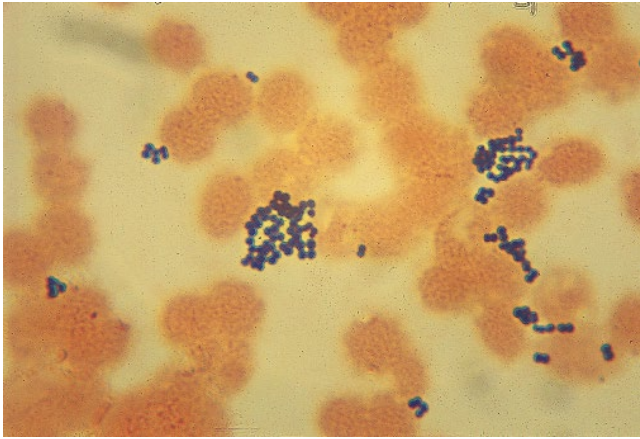


Figure 1-1 Gram stain of *Staphylococcus aureus*. A Gram stain of a positive blood culture shows Gram-positive cocci in grape-like clusters. On subculture to solid medium, *S. aureus* was isolated.

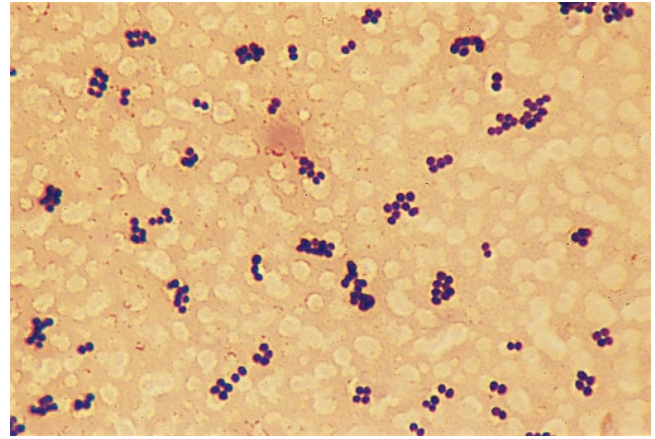


Figure 1-2 Gram stain of *Micrococcus luteus*. *M. luteus* is a Gram-positive coccus that, like *S. aureus*, can appear in pairs and clusters. However, it also tends to form tetrads, as depicted in this Gram stain.

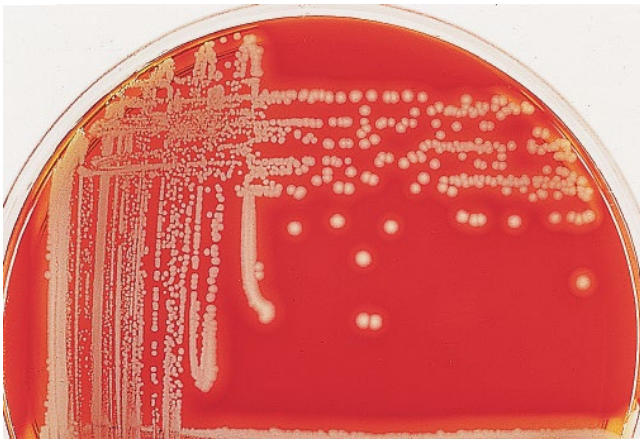


Figure 1-3 *Staphylococcus aureus* on blood agar. Shown in this image is a culture of *S. aureus* grown overnight at 35°C on blood agar. The colonies are cream colored and opaque and have a smooth, entire edge. A zone of beta-hemolysis surrounds the colony.

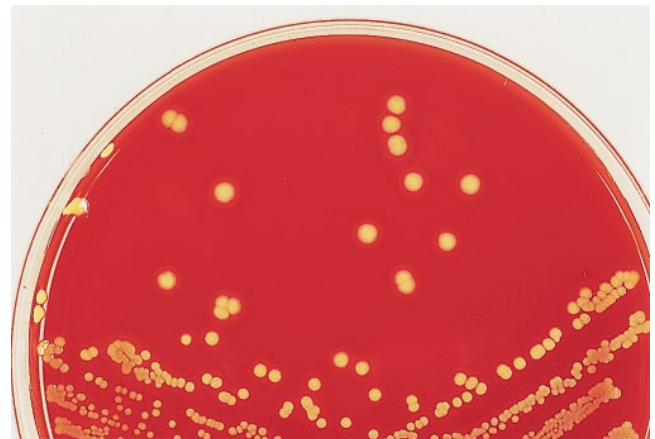


Figure 1-4 Golden pigment of *Staphylococcus aureus*. *S. aureus* is capable of producing the golden pigment that led to its species name. In practice, strains with this degree of pigment are not frequently isolated from clinical specimens. The isolate shown was incubated overnight on blood agar at 35°C and then left at room temperature for an additional day. When left at room temperature or refrigerated following incubation, isolates tend to develop more intense pigment.

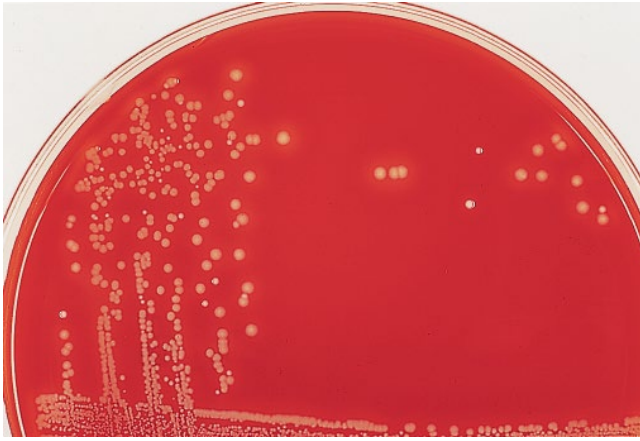


Figure 1-5 Size variation of *Staphylococcus aureus* colonies. It is not uncommon for strains of *S. aureus*, especially MRSA strains, to produce colonies that are heterogeneous in size and the degree of hemolysis. Colonies shown were grown on blood agar for 24 h at 35°C.



Figure 1-6 *Staphylococcus epidermidis* on blood agar. *S. epidermidis*, in contrast to both *S. aureus* and other CoNS, produces a white colony with little or no pigment. The isolate shown here was grown on blood agar for 24 h at 35°C. This strain of *S. epidermidis* also exhibits some variation in colony size.

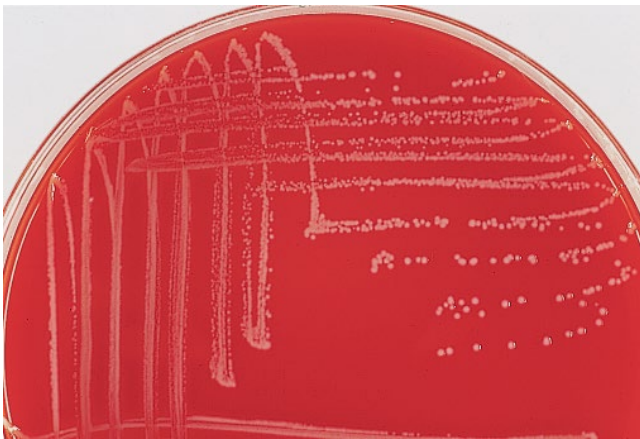


Figure 1-7 *Staphylococcus lugdunensis* on blood agar. Colonies of *S. lugdunensis* on blood agar resemble *S. epidermidis* colonies; however, they tend to be cream colored, in contrast to the typical white colonies of *S. epidermidis* (Fig. 1-6).



Figure 1-8 *Micrococcus luteus* on blood agar. A distinguishing feature of *M. luteus* is the vivid yellow colonies it produces. The isolate shown here was grown on blood agar for 72 h at 35°C. In general, *Micrococcus* is slower growing than *Staphylococcus*.

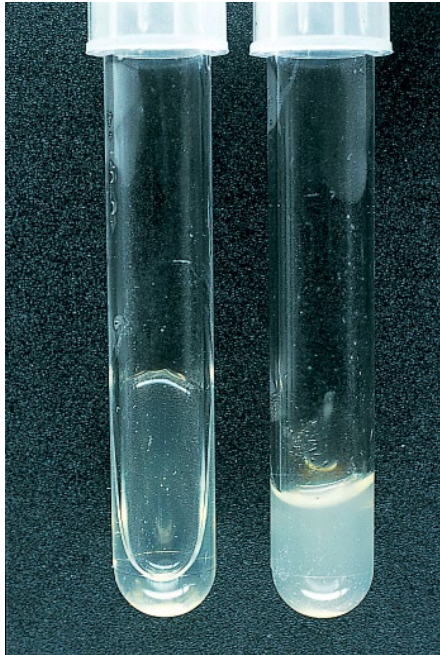


Figure 1-9 Coagulase test. A common method used to distinguish *S. aureus* from other *Staphylococcus* spp. is the tube coagulase test shown here. *S. aureus* is positive, and CoNS are negative. Colonies of the isolate to be identified were emulsified in 0.5 ml of rabbit plasma. The tube was incubated at 35°C for 4 h and tipped gently to look for clot formation. The tube on the left is negative, with the plasma remaining liquid, while the tube on the right is positive, as evidenced by the clot formation. Tubes giving negative results at 4 h should be incubated for up to 24 h.

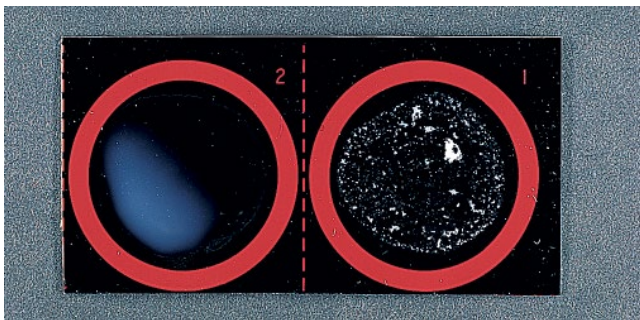


Figure 1-11 Latex test for the identification of *Staphylococcus aureus*. In the test depicted here, latex particles have been coated with antibody that can recognize bound coagulase as well as immunoglobulin that will bind to protein A present on the surface of most strains of *S. aureus*. *S. epidermidis* (left), which serves as a negative control, and the isolate to be identified (right) were emulsified with coated latex beads. The isolate shown here was identified as *S. aureus*. As with the slide coagulase test, some strains of MRSA may be negative and some strains of CoNS, namely, *S. lugdunensis* and *S. schleiferi* strains, may be positive.

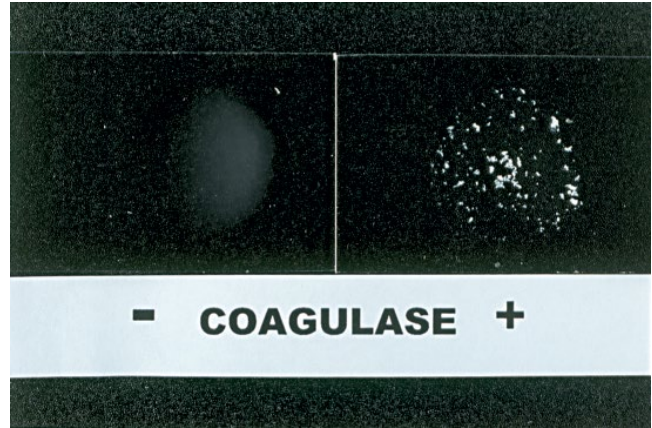


Figure 1-10 Slide coagulase test. The slide coagulase test is a rapid assay that tests for clumping factor on the surface of the organism. The test is performed by emulsifying the organism to be identified in both saline, which serves as a control for autoagglutination (left), and rabbit plasma (right). Agglutination of the organisms only in plasma is a positive result. *S. aureus* (right) is positive by this test as shown in this figure, as are strains of *S. lugdunensis* and *S. schleiferi*.

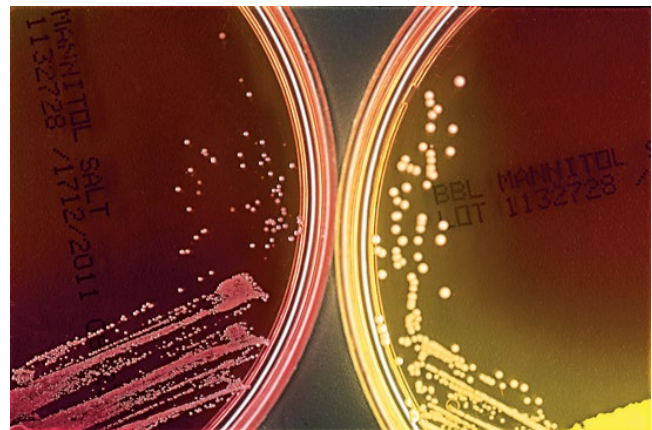


Figure 1-12 Mannitol salt agar. Mannitol salt agar is a selective and differential medium used for the isolation and presumptive identification of *S. aureus*. The high salt concentration inhibits the growth of many organisms that inhabit skin and mucosal membranes. The phenol red indicator incorporated into the medium detects acid production (yellow) resulting from the fermentation of mannitol. Here, CoNS (left) and *S. aureus* (right) were inoculated on the agar and then were incubated overnight.

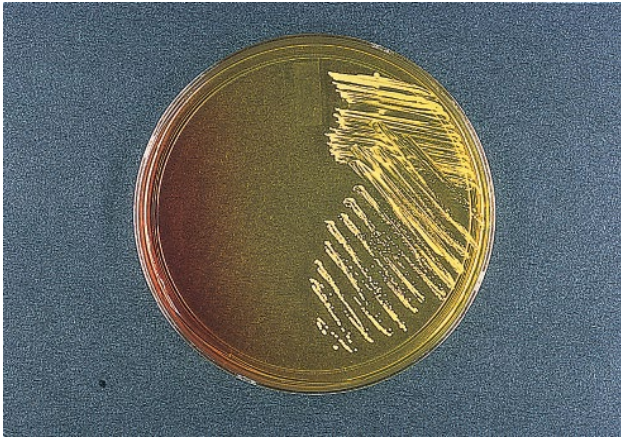


Figure 1-13 Mannitol salt agar containing oxacillin. Mannitol salt agar with oxacillin can be used to screen for the presence of MRSA in nasal specimens, since the 7.5% salt and 6 μg of oxacillin in this medium inhibit most other organisms that normally colonize the nares. MRSA turns the medium yellow as a result of the fermentation of mannitol. Pictured here is a plate inoculated with a methicillin-susceptible *S. aureus* strain (left) and a MRSA strain (right). The methicillin-susceptible *S. aureus* strain failed to grow. As with most *in vitro* testing for methicillin susceptibility, oxacillin (not methicillin) is used because of its higher stability.

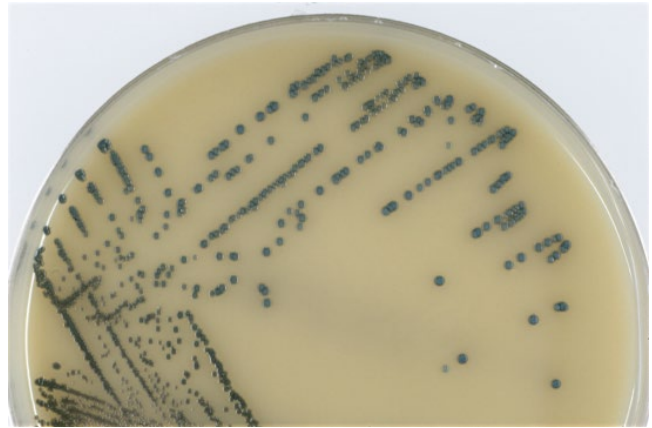
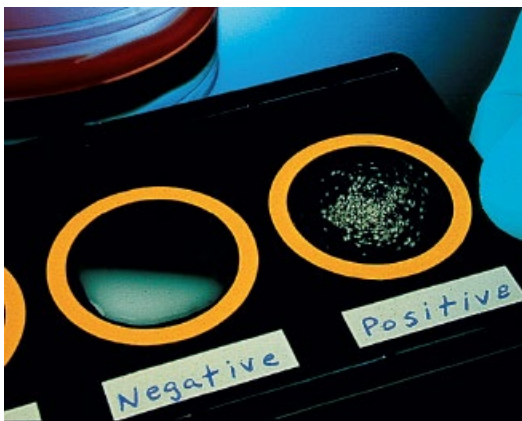


Figure 1-14 Spectra MRSA. Shown is a chromogenic medium used to detect MRSA, Spectra MRSA (Thermo Scientific, Remel Products, Lenexa, KS), which is both selective and differential. When the chromogenic substrate incorporated into the inhibitory agar is degraded by the enzymatic action of MRSA, the colony takes on a denim blue color. Shown here is an overnight nasal culture from which MRSA was isolated.



A



B

Figure 1-15 Assays to detect PBP2a found in MRSA. (A) The product of the *mecA* gene, which results in methicillin resistance, is an altered penicillin-binding protein, PBP2a. Monoclonal antibody to this altered protein was used to coat latex particles, which were then used in the Oxoid agglutination assay to detect PBP2a. (B) Shown is the Alere PBP2a SA Culture Colony Test (Alere Scarborough, Inc., Scarborough, ME), a lateral flow assay that utilizes monoclonal antibodies for the detection of PBP2a. Both formats are rapid tests that are used once the organism is isolated on solid medium.

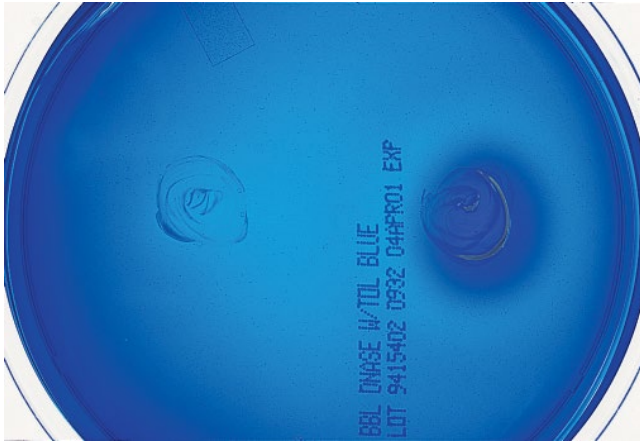


Figure 1-16 DNase plate to differentiate *Staphylococcus aureus* from CoNS. *S. aureus* produces DNase, which can degrade DNA. This property is used to aid in the differentiation of CoNS (left) from *S. aureus* (right). This is particularly useful for identification of *S. aureus* strains that produce a small amount of coagulase, thus giving an equivocal or weakly positive coagulase test. The only CoNS species that shares this property with *S. aureus* is *S. schleiferi*. In this test, a heavy inoculum of the organism is used to spot an agar plate that contains DNA and toluidine blue. If the organism produces DNase (right), the DNA is degraded, resulting in the agar turning pink in the area surrounding the inoculum due to the metachromatic qualities of toluidine blue.

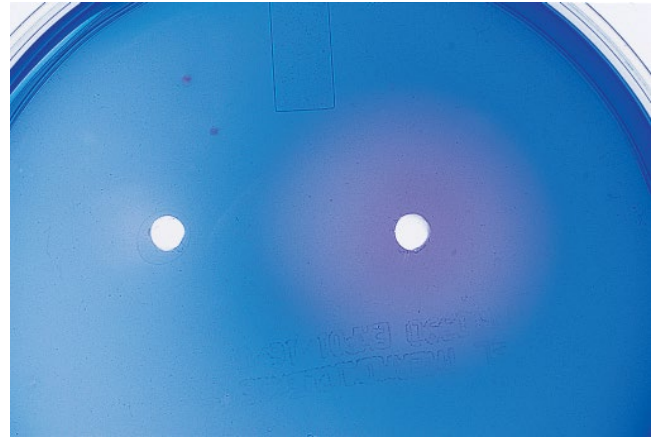


Figure 1-17 Thermostable endonuclease activity. In addition to DNase, *S. aureus* produces a thermostable endonuclease that can also cleave DNA. To test for this activity, a heavy suspension of the organism is boiled and then used to fill a well that is cut in the DNA plate containing toluidine blue. As described in the legend to Fig. 1-16, if the DNA is degraded, there is a change in the color of the agar from blue to pink. *S. epidermidis* does not produce a heat-stable endonuclease (left), whereas the *S. aureus* strain (right) does, as shown by the pink zone around the well containing *S. aureus*.

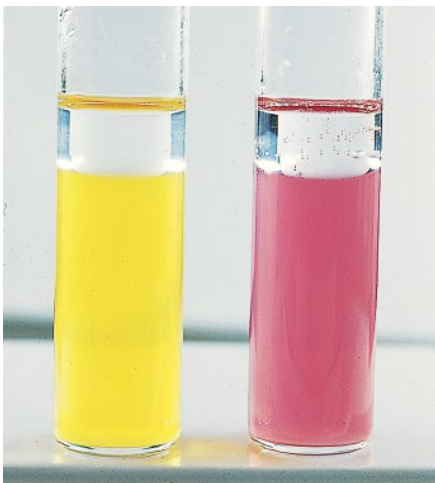


Figure 1-18 Ornithine decarboxylase test for the identification of *Staphylococcus lugdunensis*. Unlike most other CoNS species, *S. lugdunensis* is ornithine decarboxylase positive. Decarboxylase medium containing 1% ornithine is inoculated and incubated overnight. Since some strains of *S. epidermidis* can also be positive at 24 h, the specimen should be examined at 8 h, a time at which *S. lugdunensis* is positive but *S. epidermidis* is still negative. The isolate on the left, *S. saprophyticus*, is negative since it is yellow, indicating only fermentation of glucose; however, *S. lugdunensis* (right) is positive, as shown by the rose color resulting from the alkalization of the medium.



Figure 1-19 Novobiocin susceptibility. *S. saprophyticus* can be differentiated from other clinically significant CoNS isolates by its resistance to the antibiotic novobiocin. As pictured, Mueller-Hinton agar was inoculated with suspensions equivalent to a 0.5 McFarland standard of *S. saprophyticus* (left) and *S. epidermidis* (right). Novobiocin disks (5 µg) were placed on the agar surface, which was incubated for 24 h at 35°C. Zones of inhibition measuring ≤16 mm indicate novobiocin resistance, as seen with this isolate of *S. saprophyticus*, which has no zone of inhibition. In contrast, the susceptible *S. epidermidis* isolate has a large zone of inhibition around the novobiocin disk.



Figure 1-20 Bacitracin susceptibility. The same procedure used to test for the bacitracin susceptibility of *Streptococcus pyogenes* can be used to differentiate staphylococci, which are bacitracin resistant, from micrococci, which are susceptible. Here, *S. epidermidis* (left) is not inhibited, as shown by growth up to the disk containing 0.04 U of bacitracin, whereas *M. luteus* (right) exhibits a zone of inhibition around the bacitracin disk.

Figure 1-21 Lysostaphin susceptibility. Several species of *Staphylococcus* are susceptible to the endopeptidase lysostaphin, which cleaves the glycine-rich pentapeptide that is essential for cross bridging the cell wall. Cleavage of these basic units weakens the cell wall, making it susceptible to lysis. Depending on the makeup of this pentapeptide, specifically the glycine content, susceptibility to lysostaphin can vary. For example, while *S. aureus* is very susceptible, *S. saprophyticus* is less susceptible due to the serine content of its pentapeptide bridge. Micrococci are not susceptible to lysostaphin. As shown here, the test is performed by making a heavy suspension of the unknown organism in saline and then adding an equal volume of lysostaphin reagent. Clearing of the suspension after 2 h at 35°C indicates lysis of the organisms. In the example shown here, the lysostaphin test medium inoculated with *M. luteus* (left) remained turbid and thus was negative, in contrast to the tube on the right, which was inoculated with *S. aureus* and is positive, as shown by clearing or lysis of the bacterial suspension. This assay can also be performed as a disk diffusion test.





Figure 1-22 Modified oxidase test. A modified oxidase test, the Microdase test (Thermo Scientific, Remel Products), is available for differentiating micrococci from staphylococci. Micrococci possess cytochrome *c*, which is essential for producing a positive oxidase reaction, whereas clinically relevant staphylococci are oxidase negative, since they lack cytochrome *c*. In the example shown, a colony of *S. epidermidis* (left) and a colony of *M. luteus* (right) were rubbed onto a disk impregnated with tetramethyl-*p*-phenylenediamine (TMPD) dissolved in dimethyl sulfoxide. Development of a purple-blue color within 2 min indicates a positive test due to the reaction of the enzyme oxidase with cytochrome *c* and TMPD.

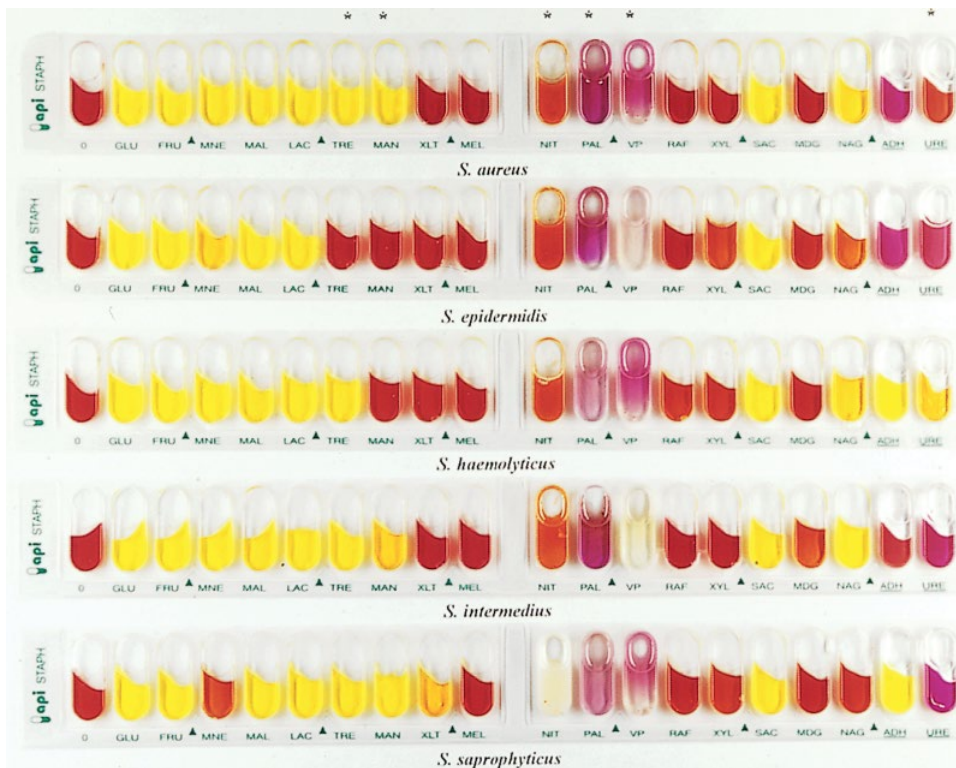


Figure 1-23 API Staph identification system. API Staph (bioMérieux, Inc., Durham, NC) is a commercial system that can differentiate among several *Staphylococcus* species. Each test strip consists of 20 microtubes, including the negative control well. Key reactions that aid in the differentiation and identification of the five *Staphylococcus* species shown are indicated by asterisks at the top.

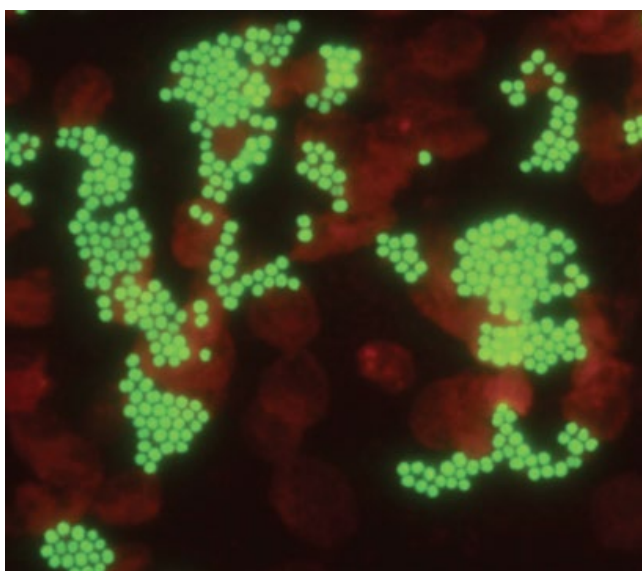


Figure 1-24 PNA FISH for the differentiation of *Staphylococcus aureus* from CoNS in blood cultures. PNA FISH (AdvanDx, Woburn, MA) is a 90-min fluorescence *in situ* hybridization (FISH) assay utilizing fluorescence-labeled peptide nucleic acid (PNA). It is performed directly from blood culture bottles that are positive for Gram-positive cocci in clusters. In the example shown, the Gram-positive cocci are *S. aureus*, which hybridized with a green fluorescent probe. (Courtesy of AdvanDx.)

Streptococcus

2

The genus *Streptococcus* is composed of over 100 species and subspecies which are a predominant component of the normal bacterial microbiota of the respiratory, gastrointestinal, and genital tracts of humans. Members of this genus are Gram-positive cocci that occur in pairs and/or chains and are catalase-negative, facultative anaerobes that metabolize carbohydrates by fermentation, producing mainly lactic acid.

Traditionally, streptococci have been grouped by the phenotypic characteristics of hemolysis and Lancefield antigen composition as well as by pathogenic potential. While these are still useful ways to group organisms, there are many exceptions and overlapping characteristics with each grouping system; therefore, genetic analysis is a more definitive method for classifying these organisms. However, from a practical standpoint, phenotypic characteristics are very useful in identification algorithms. Streptococci can be either beta-hemolytic (complete hemolysis), alpha-hemolytic (incomplete hemolysis resulting in a green zone around the colony), or gamma-hemolytic (no hemolysis) on blood agar. With the Lancefield system, depending on the cell wall carbohydrate (Lancefield antigen) or lipoteichoic acid (group D), some of the streptococci have been placed in groups A, B, C, D, F, and G. Most members of the Lancefield groups are beta-hemolytic, the exception being group D, which is composed of alpha-hemolytic or nonhemolytic organisms.

STREPTOCOCCUS PYOGENES **(GROUP A BETA-HEMOLYTIC STREPTOCOCCI)**

Streptococcus pyogenes organisms are beta-hemolytic streptococci possessing the group A Lancefield antigen. *S. pyogenes* is one of the more virulent *Streptococcus* species and is responsible for a wide range of clinical entities, including pharyngitis, impetigo, bacteremia, and soft tissue infections. Sequelae resulting from infection include rheumatic fever, glomerulonephritis, the scarlatiniform rash of scarlet fever, toxic shock-like syndrome, and necrotizing fasciitis.

Direct detection of *S. pyogenes* based on the Lancefield group A antigen is commonly performed on throat specimens. There are several commercial kits available for direct detection of this antigen that have high specificity but vary in sensitivity. Therefore, especially with children, for whom the incidence of infection and potential to develop sequelae are greater, it is recommended that negative direct antigen tests be followed up by culture. Alternatively, direct detection of *S. pyogenes* by DNA amplification methods is more sensitive than direct antigen detection. Since, in contrast to culture, the sensitivity of some DNA-based amplification assays is >90%, culture confirmation is not required for negative amplification results. For culture, *S. pyogenes* is commonly isolated using blood agar incubated in 5% CO₂. Trimethoprim-sulfamethoxazole can be incorporated into the blood

agar to increase the selection of *S. pyogenes*. Antibodies specific for the group A Lancefield carbohydrate antigen can be used to identify *S. pyogenes*. Bacitracin susceptibility has also traditionally been used to identify large-colony beta-hemolytic organisms. Here, a 0.04-U bacitracin disk is applied to a lawn of the organism, and the formation of any zone of inhibition is considered a positive result. Another useful rapid biochemical test for identification of *S. pyogenes* is the PYR test, in which the enzyme pyrrolidonyl arylamidase is detected. Matrix-assisted laser desorption ionization-time of flight mass spectrometry (MALDI-TOF MS) has also been shown to be useful in identifying *S. pyogenes*.

Small-colony beta-hemolytic organisms can also possess the Lancefield group A antigen; however, these isolates are classified as members of the viridans group streptococci, anginosus group. Small-colony (*Streptococcus anginosus*) and large-colony (*S. pyogenes*) group A streptococci can be differentiated biochemically in that *S. pyogenes* is PYR positive and Voges-Proskauer test (VP) negative, while the opposite is true of *S. anginosus*.

Serological tests are available to detect the host response to the group A antigen and M protein as well as extracellular products associated with *S. pyogenes*, e.g., streptolysin O (antistreptolysin O test) and DNase B. These tests are used to aid in the diagnosis of patients with sequelae consistent with a past infection with *S. pyogenes*. Sequencing of regions coding for the M protein, a main virulence factor of *S. pyogenes*, can also be used to type strains in epidemiological investigations.

STREPTOCOCCUS AGALACTIAE

Beta-hemolytic streptococci that possess the Lancefield group B antigen are classified as *Streptococcus agalactiae*. While these organisms can cause a variety of human infections, particularly in compromised hosts, they are best known as a leading cause of newborn infections due either to transmission at birth, to maternal colonization of the intestinal and/or genitourinary tract, or to postnatal acquisition.

In an effort to reduce the exposure of newborns, in 2010 the CDC recommended screening of pregnant females at 35 to 37 weeks of gestation by culture for *S. agalactiae*. However, in 2019 the American College of Obstetricians and Gynecologists changed this time frame to 36 to 37 weeks. For detection of colonization of pregnant females, a swab(s) from the distal vagina and ano-rectum should be collected. Swabs are then used to inoculate blood agar and placed in an enrichment broth

containing antibiotics, e.g., colistin (10 µg/ml) or gentamicin (8 µg/ml) and nalidixic acid (15 µg/ml). In the event that the primary plate is negative for *S. agalactiae*, the enrichment broth is subcultured to blood agar after 18 to 24 h of incubation. In general, colonies of *S. agalactiae*, in contrast to *S. pyogenes*, produce a narrow zone of beta-hemolysis on blood-based agar. Alternatively, carrot broth and Granada medium, which turn orange in the presence of *S. agalactiae*, have been used to detect the presence of this organism; however, nonhemolytic strains may not be detected with pigment-dependent differential media. Testing enrichment broth after overnight incubation using nucleic acid amplification techniques (NAAT) has been found to be very sensitive, thus presenting an alternative to culturing on solid agar. NAAT have been used to test females in labor that have not had a screening test performed. However, since the enrichment culture is eliminated in this test, the sensitivity has been shown to be reduced, and this method is therefore not recommended by the CDC.

S. agalactiae can be identified by Lancefield typing using antibodies to detect the group B antigen. In addition, a CAMP (Christie, Atkins, Munch-Petersen) test can be performed to detect a protein, CAMP factor, produced by *S. agalactiae*. To detect the CAMP factor, *S. agalactiae* is streaked at right angles to a strain of *Staphylococcus aureus* that produces a beta-hemolysin that synergistically interacts with the CAMP factor. If *S. agalactiae* is present, hemolysis in the shape of an arrowhead is seen where the two lines of bacterial growth intersect. Disks impregnated with the *Staphylococcus* hemolysin are commercially available that also enable the detection of enhanced hemolysis in the presence of the CAMP factor produced by *S. agalactiae*. Alternatively, *S. agalactiae* can be presumptively identified by its ability to hydrolyze hippurate. Both rapid (2-h) and overnight versions of this test are based on the hydrolysis of hippurate to glycine, which can subsequently be detected with the ninhydrin reagent. Alternatively, MALDI-TOF MS can be used to identify *S. agalactiae*.

***STREPTOCOCCUS DYSGALACTIAE* SUBSP. *EQUISIMILIS* (LARGE- COLONY BETA-HEMOLYTIC LANCEFIELD GROUPS C AND G)**

Human isolates of large-colony beta-hemolytic streptococci that possess either the Lancefield group C or G antigen, and occasionally Lancefield group A and L antigens, are genetically related and have been placed in the same

subspecies, *Streptococcus dysgalactiae* subsp. *equisimilis*. These organisms cause an acute disease spectrum similar to that of *S. pyogenes*; however, they are not generally associated with sequelae, although there are reports of exceptions. *S. dysgalactiae* subsp. *equisimilis* strains are not the only streptococci possessing the Lancefield C and G antigens. Other large-colony strains possessing the group C or G antigen, which may be alpha- or beta-hemolytic or nonhemolytic, are found primarily in animals and can cause zoonoses.

Human isolates are generally identified by typing large-colony beta-hemolytic strains with antibodies to the Lancefield groups. However, small-colony beta-hemolytic organisms can also type as group C or G but are members of the viridans group streptococci, belonging to the anginosus group. Large- and small-colony beta-hemolytic group C and G streptococci can be differentiated from one another by a VP for acetoin or a rapid test to detect β -D-glucuronidase (BGUR), since large-colony isolates are positive by this test but negative by the VP. This enzyme can also be rapidly detected using methylumbelliferyl- β -D-glucuronide-containing MacConkey agar. Unlike with *S. pyogenes* and *S. agalactiae*, to date, identification of *S. dysgalactiae* by MALDI-TOF MS has been problematic, as it has been with identifying members of the viridans group streptococci.

STREPTOCOCCUS PNEUMONIAE

Streptococcus pneumoniae belongs to the *Streptococcus mitis* group of the viridans group streptococci; however, due to their unique phenotypic and clinical manifestations, these species are discussed separately. *S. pneumoniae* is part of the normal respiratory microbiota, and carriage of this organism is common. It is one of the leading causes of community-acquired pneumonia. In addition, it can cause bacteremia, endocarditis, meningitis, sinusitis, and otitis media. There are over 90 serotypes of *S. pneumoniae* based on difference in the polysaccharide capsule. Vaccines incorporating 13 or 23 of these antigens have had an impact in reducing infections caused by *S. pneumoniae*. Traditionally, this organism was universally susceptible to penicillin; however, increasing numbers of strains have developed decreased susceptibility to this first-line antimicrobial agent. A key characteristic of this Gram-positive organism is its lancet-shaped appearance in a Gram stain. Encapsulated strains, which often are more pathogenic due to the antiphagocytic characteristics of the capsule, can be detected by Gram stain when the combination of a proteinaceous background

and correct illumination allows a halo (i.e., capsule) around the organism to be visible.

S. pneumoniae grows on blood agar and often needs incubation in 5% CO₂ for optimal growth. Colonies are alpha-hemolytic and can be mucoid in appearance due to a capsule. As the colonies age, they tend to be described as concave and can appear to have a punched-out center. Strains of *S. pneumoniae* have been defined by their capsular antigens, and over 80 serotypes have been identified. Swelling of the capsule in the presence of type-specific antibodies is referred to as a Quellung reaction. Alternatively, strains can be typed using commercially available agglutination tests.

The two tests that are most widely used to identify *S. pneumoniae* are those for bile solubility and optochin susceptibility. Sodium deoxycholate to test for bile solubility, when added to *S. pneumoniae* growing in broth or on solid media, causes lysis of the organisms. Zones of inhibition of ≥ 14 mm with a 6-mm, 5- μ g optochin disk can also be used to distinguish *S. pneumoniae* from other alpha-hemolytic streptococcal organisms. Strains that once were considered *S. pneumoniae* that were not bile soluble or optochin susceptible have recently been included in the species *Streptococcus pseudopneumoniae*, which is also included in the *S. mitis* group. Depending on the database used, misidentification of isolates from the viridans group as *S. pneumoniae* by MALDI-TOF has been reported. However, recent versions of the databases of the two commercially available instruments have shown improvement in correctly identifying *S. pneumoniae*.

Urine and cerebrospinal fluid antigen tests for *S. pneumoniae* are commercially available. These tests have been found to be useful in adult patients that have been treated with antibiotics and in patients with pneumonia who also had a bloodstream infection. Direct NAAT, depending on the application, have been problematic partly due to the inability to distinguish between the normal microbiota and organisms causing respiratory infection. Mixed results have been reported with NAAT when they are used as part of a panel for testing positive blood cultures or cerebrospinal fluid.

VIRIDANS GROUP STREPTOCOCCI

The main species of the viridans group streptococci can be placed in either the bovis, mitis, anginosus, mutans, or salivarius group (Table 2-1). As with other organisms in the genus *Streptococcus*, the viridans group streptococci are normal inhabitants of the mucosal membranes and therefore are commonly found in the gastrointestinal

Table 2-1 Grouping of the viridans group streptococci more commonly associated with human disease

Group	Included species
Bovis	<i>S. gallolyticus</i> <i>S. infantarius</i> <i>S. alactolyticus</i>
Mitis	<i>S. mitis</i> <i>S. pneumoniae</i> <i>S. pseudopneumoniae</i> <i>S. cristatus</i> <i>S. gordonii</i> <i>S. oralis</i> <i>S. parasanguinis</i> <i>S. sanguinis</i>
Anginosus (milleri)	<i>S. anginosus</i> <i>S. constellatus</i> <i>S. intermedius</i>
Mutans	<i>S. mutans</i> <i>S. criceti</i> <i>S. downei</i> <i>S. ratti</i> <i>S. sobrinus</i>
Salivarius	<i>S. salivarius</i> <i>S. vestibularis</i>

and urogenital tracts as well as the oral cavity. Several viridans group species are associated with dental caries and subacute bacterial endocarditis, particularly in patients with damaged or prosthetic heart valves. It is not uncommon to isolate them from polymicrobial abscesses. *Streptococcus intermedius* can be found in deep abscesses, particularly of the brain and liver. Infections with the viridans group are becoming more frequent in neutropenic patients, probably due to the oral mucosal damage from some of the chemotherapeutic agents used.

It has traditionally been difficult to determine the species identity of the viridans group in the clinical laboratory setting. This is in part because they lack characteristic hemolytic reactions in that they can be alpha-hemolytic or nonhemolytic and occasional strains are beta-hemolytic. With the exception of members of the *Streptococcus bovis* group which, along with the genus *Enterococcus*, possess the group D antigen, most viridans group streptococci lack distinct Lancefield antigens. In addition, several nomenclature systems have evolved to describe members within the viridans group. Commercial systems that can identify species in this group are available, and with continued refinement of databases and consolidation of nomenclature, they should prove very useful. Several conventional tests can be used to group and sometimes identify species of the viridans group streptococci. Key tests include the urea hydrolysis test, which is performed on Christensen urea

agar incubated at 35°C for 7 days; the VP for acetoin production; the arginine hydrolysis test, which can be done by different methods (depending on the method and the species, results of this test can vary); the esculin hydrolysis test, which can be performed using commercially available slants that are observed for blackening for up to 1 week; fermentation using 1% (wt/vol) carbohydrate in thioglycolate broth containing purple broth base (1.6% [wt/vol]), which is inoculated and incubated anaerobically for 24 h; and the test for hyaluronidase production, which can be detected on agar plates containing 400 µg of hyaluronic acid. The use of fluorogenic substrates has also aided in the differentiation of species of viridans group streptococci; by this method, 4-methylumbelliferyl-linked substrates are degraded, and the by-product can be visualized under UV illumination. Differentiating among the viridans group streptococci by MALDI-TOF MS remains problematic.

***S. bovis* Group (Group D Streptococci)**

Nomenclature of organisms in the bovis group of viridans group streptococci has changed over the years, especially with the knowledge gained from molecular methods; still, as with the other groups within the viridans group, there is often confusion around the grouping and nomenclature of these organisms. Recently, the *S. bovis* group was subdivided based on DNA studies into four clusters. Organisms in cluster I, which are mainly isolated from animals, include strains formerly called *Streptococcus bovis* and *Streptococcus equinus* that are now grouped into a single species, *S. equinus*. Strains in the bovis group causing human infections belong mainly to cluster II. The revised nomenclature for this group includes *Streptococcus gallolyticus*, which comprises three subspecies, *Streptococcus gallolyticus* subsp. *gallolyticus*, *S. gallolyticus* subsp. *pasteurianus*, and *S. gallolyticus* subsp. *macedonicus*. Importantly, there is a strong association of isolation of *S. gallolyticus* from blood cultures with colorectal cancer. In addition, *S. gallolyticus* can cause bacteremia, endocarditis, and meningitis. Also clinically important are *Streptococcus infantarius* subsp. *infantarius* and *Streptococcus infantarius* subsp. *coli* in cluster III. Cluster IV includes *Streptococcus alactolyticus*, which also has been reported to be isolated from human infections, although less commonly than other members in this group.

Members of the *S. bovis* group are alpha-hemolytic or nonhemolytic on blood agar, which is commonly used to isolate these organisms. They can be differentiated from other alpha-hemolytic and nonhemolytic

streptococci primarily by biochemical reactions. Key characteristics of the *S. bovis* group, along with possession of the group D Lancefield antigen, that can be used to distinguish *S. bovis* from other viridans group streptococci are the ability to grow in the presence of 40% bile and hydrolyze esculin; the lack of sorbitol fermentation; the ability to ferment mannitol, inulin, and starch; and the inability to produce urease. *S. bovis* strains can be differentiated from *Enterococcus* spp., which are also bile-esculin positive, by their inability to grow at 45°C or in 6.5% NaCl at 35°C and by the fact that they are PYR negative.

Mitis Group

The nomenclature of the mitis group of streptococci, which includes among others *Streptococcus mitis*, *S. oralis*, *S. sanguinis*, *S. parasanguinis*, *S. gordonii*, and *S. cristatus*, has varied; therefore, depending on the criteria used for identification, different species names have been assigned to similar organisms, making disease associations difficult. Members of this group are associated with endocarditis and with dental plaque. *S. mitis* has been isolated from the blood more frequently in patients undergoing chemotherapy and radiation treatment, most probably due to the oromucositis in these patients.

Members of this group are alpha-hemolytic. Some of the key biochemical reactions for the viridans group, notably production of acetoin (VP), urease, and hyaluronidase, are negative for members of the mitis group. Arginine hydrolysis can be used to differentiate *S. oralis* and *S. mitis* from the other members of the group since these two species are negative. The majority of strains of *S. sanguinis* and *S. gordonii* form hard, adherent, smooth colonies due to the extracellular production of dextran.

Anginosus Group

Three species, *Streptococcus anginosus*, *Streptococcus constellatus*, and *Streptococcus intermedius*, compose the anginosus group, which has also been referred to as the *Streptococcus milleri* group. These organisms are known to cause endocarditis and purulent infections of the liver, brain, abdomen, pleural cavity, and head and neck region.

Members of this group generally form small colonies and can be alpha- or beta-hemolytic or nonhemolytic. However, *S. constellatus* is commonly beta-hemolytic, whereas strains of *S. intermedius* are often nonhemolytic. They are not characterized by a particular Lancefield

antigen, since strains are unable to be placed in a group that can be easily tested. However, *S. intermedius* strains seem more homogeneous in this regard in that they possess the Lancefield group F antigen. Growth of this group is often enhanced by the presence of CO₂ or anaerobic conditions. Many strains, due to the production of diacetyl, produce a butterscotch-type sweet odor when growing on solid media.

These organisms are arginine positive, VP positive, and urease negative. The three species can be difficult to differentiate from one another, but tests that can be used are those for hyaluronidase (*S. anginosus* is negative), β-D-fucosidase activity (*S. intermedius* is positive), and β-D-glucosidase (*S. constellatus* is negative and *S. intermedius* is variable).

Mutans Group

The mutans group, especially *Streptococcus mutans*, is known for its association with dental caries. Of the species in this group, *S. mutans* and *Streptococcus sobrinus* are the most frequently isolated from human dental plaque, whereas *Streptococcus criceti*, *Streptococcus downei*, and *Streptococcus rattii* are seldom found in humans. The other species in this group are isolated primarily from animals and therefore are not discussed here. *S. mutans* in general is alpha-hemolytic, with a few strains exhibiting beta-hemolysis, while *S. criceti* is nonhemolytic, with a few alpha-hemolytic strains. By Gram staining, *S. mutans* occasionally appears as short bacilli. Members of this group are arginine negative, esculin positive, VP positive, urease negative, and hyaluronidase negative.

Salivarius Group

The two species in the salivarius group associated with human disease, *Streptococcus salivarius* and *Streptococcus vestibularis*, are inhabitants of the oral cavity, whereas the third species, *Streptococcus thermophilus*, is found primarily in dairy products. Members of this group do not appear to be virulent, but *S. salivarius* can cause septicemia in neutropenic patients. Most strains are alpha-hemolytic, with occasional strains being nonhemolytic. *S. salivarius* occasionally types as Lancefield group K. Production of extracellular polysaccharide on sucrose agar gives *S. salivarius* colonies a large, mucoid appearance; alternatively, they can appear as large, hard colonies that pit the agar. *S. vestibularis* is urease positive and does not produce extracellular polysaccharides like *S. salivarius*.



Figure 2-1 Gram stain of *Streptococcus pyogenes*. *S. pyogenes* (group A streptococcus) is a Gram-positive coccus that is usually seen in pairs and chains. The Gram stain shown is from a blood culture.

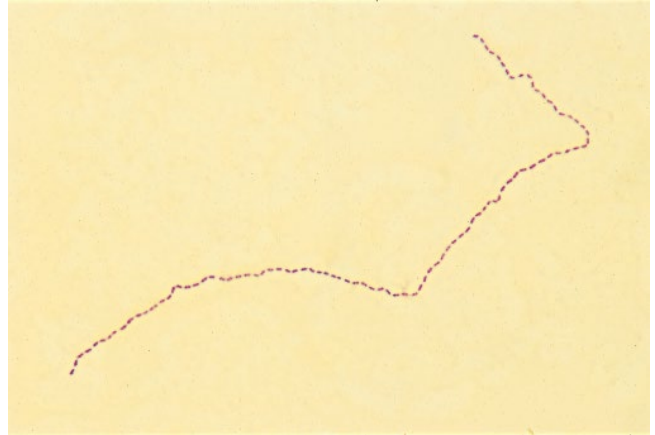


Figure 2-2 Gram stain of viridans group streptococci. Viridans group streptococci tend to form long chains of Gram-positive cocci, as seen in this Gram stain of a blood culture. They often do not stain well, giving the impression they are not as healthy as other streptococci.

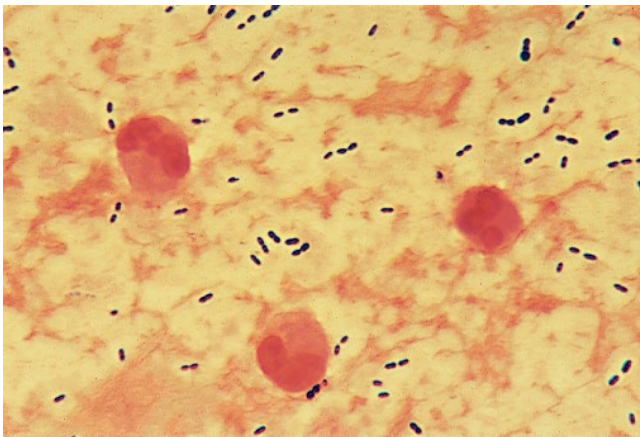


Figure 2-3 Gram stain of *Streptococcus pneumoniae*. This direct smear of a sputum specimen that grew predominantly *S. pneumoniae* shows the typical morphology of lancet-shaped, Gram-positive cocci in pairs. Against the pink proteinaceous background of the specimen, the capsule of *S. pneumoniae* can be seen as a clear halo around the organisms.

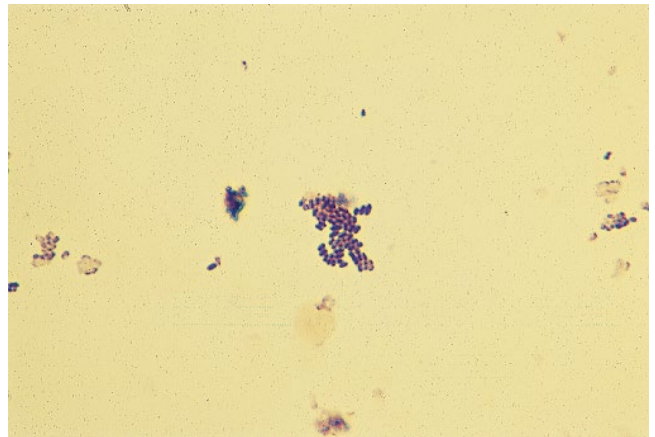


Figure 2-4 Gram stain of *Streptococcus mutans*. *S. mutans* can appear as cocci or even elongate to resemble bacilli, as demonstrated by the Gram stain shown here. The organisms shown were grown on blood agar overnight; however, growth in acidified broth is reported to also produce elongated forms of this organism.

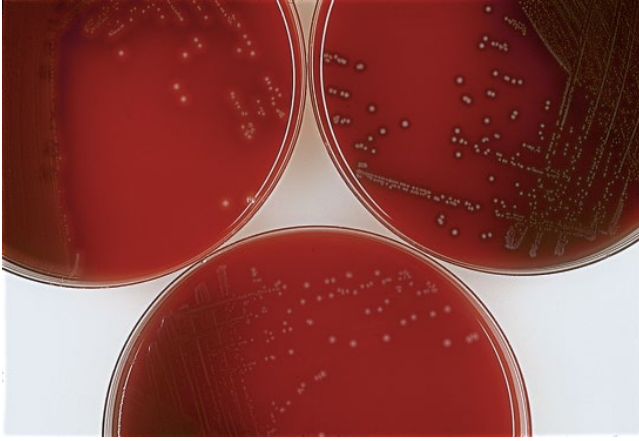


Figure 2-5 Beta-, alpha-, and gamma-hemolysis on blood agar. A key characteristic commonly used in identifying *Streptococcus* spp. is the type of hemolysis produced on blood agar. The three types of hemolysis are gamma-hemolysis (or no hemolysis); alpha-hemolysis, which appears as a greening of the agar around the bacterial colony; and beta-hemolysis, in which the red cells surrounding the colony are completely lysed, which results in a clear zone around the colony. Pictured are streptococci on blood agar that produce beta-hemolysis (top left), alpha-hemolysis (top right), and gamma-hemolysis (bottom).



Figure 2-6 *Streptococcus pyogenes* on blood agar. *S. pyogenes* (group A streptococcus) produces a large zone of beta-hemolysis around a relatively small colony. This organism typically is translucent and has the appearance of a small water drop on a larger zone of beta-hemolysis. Colonies have a defined, smooth edge. Undercutting the agar, as shown in the lower right corner of this plate, often results in an exaggerated hemolytic reaction, due to reduced oxygen and the resulting contribution of both the oxygen-stable and -labile hemolysins.

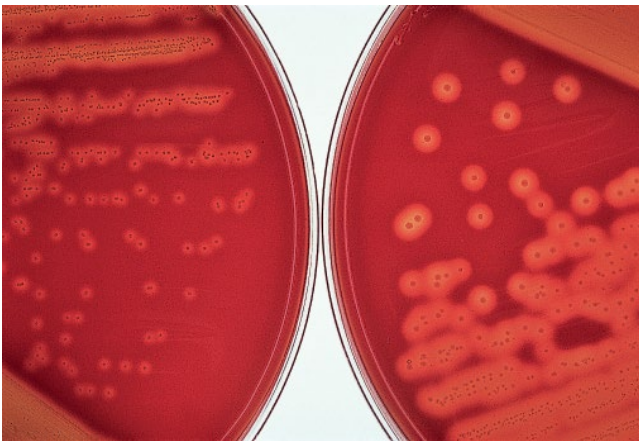


Figure 2-7 *Streptococcus pyogenes* and *Streptococcus constellatus* on blood agar. *S. constellatus*, or small-colony group A streptococcus (left), can be confused with *S. pyogenes* (right), referred to as large-colony group A streptococcus, because both type with Lancefield group A antisera and are beta-hemolytic on blood agar. The blood agar plates shown were incubated for 48 h, and there is a marked difference in the colony size, with colonies of *S. constellatus* being smaller.

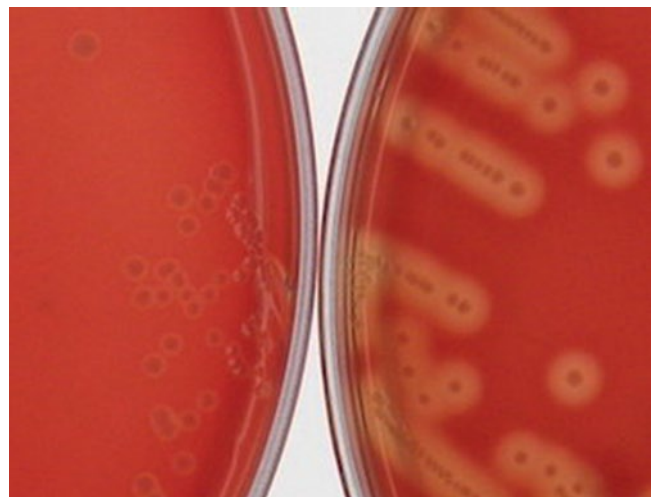


Figure 2-8 *Streptococcus agalactiae* on blood agar. In contrast to *S. agalactiae* (left), or group B streptococcus, which produces a small zone of beta-hemolysis relative to a large colony, *S. pyogenes* (right) produces a large zone of beta-hemolysis relative to the colony size. The blood agar plates shown here were incubated for 24 h.

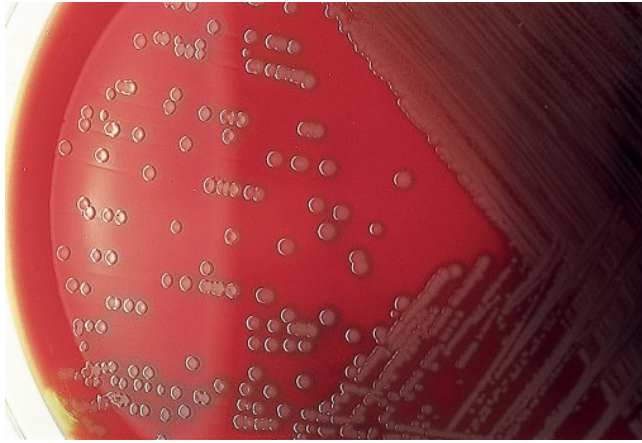


Figure 2-9 *Streptococcus pneumoniae* on blood agar. When grown on blood agar, *S. pneumoniae* produces a zone of alpha-hemolysis and the middle of the colony often appears to be indented or punched out due to autolysis of organisms in the center of the growing colony.



Figure 2-10 *Streptococcus pneumoniae* with a large capsule grown on chocolate agar. This strain of *S. pneumoniae*, in contrast to the *S. pneumoniae* strain in Fig. 2-9, appears mucoid when grown on chocolate agar. The mucoid appearance is related to capsule production.

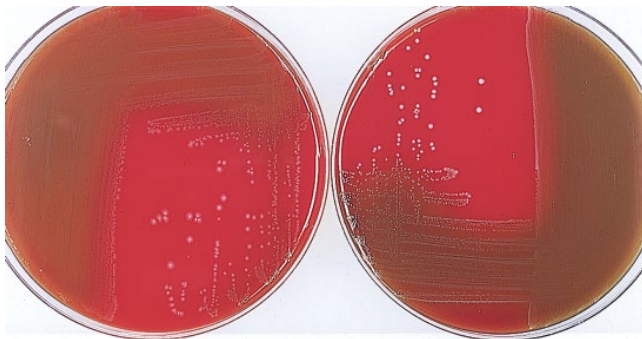


Figure 2-11 *Streptococcus bovis* group (group D) and *Enterococcus faecium* on blood agar. In general, on blood agar, members of the bovis group (left) produce alpha-hemolytic colonies that, as shown, can be confused with *E. faecium* (right).

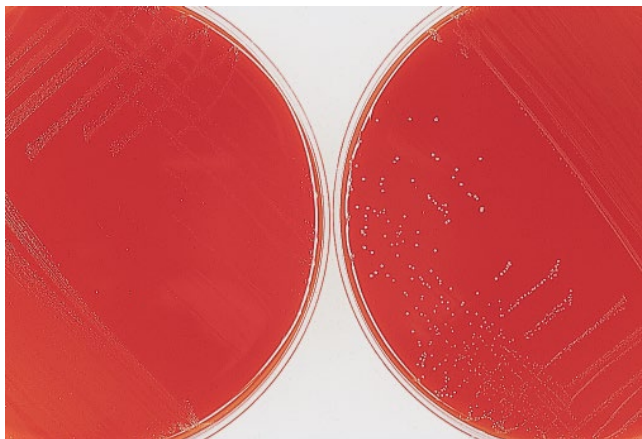


Figure 2-12 Growth enhancement of *Streptococcus constellatus* in the presence of 5% CO₂. Viridans group streptococci belonging to the anginosus group frequently grow better in 5% CO₂ or under anaerobic conditions than under aerobic conditions. This is demonstrated here for *S. constellatus*, which was grown on blood agar and incubated overnight in air (left) or in the presence of 5% CO₂ (right).

Figure 2-13 Selection for *Streptococcus agalactiae* (group B streptococcus). Pregnant females are screened for the presence of *S. agalactiae* at 36 to 37 weeks of gestation by obtaining a vaginal-anorectal swab. Specimens are plated onto blood agar and placed in a selective broth as shown here. If *S. agalactiae* is not isolated from blood agar after overnight incubation, the enhancement broth is subcultured to blood agar and incubated overnight. In the culture shown, *S. agalactiae* was not isolated from the primary blood plate (A); however, in the subculture (B) of the LIM broth, there was marked enhancement in the growth of *S. agalactiae*.

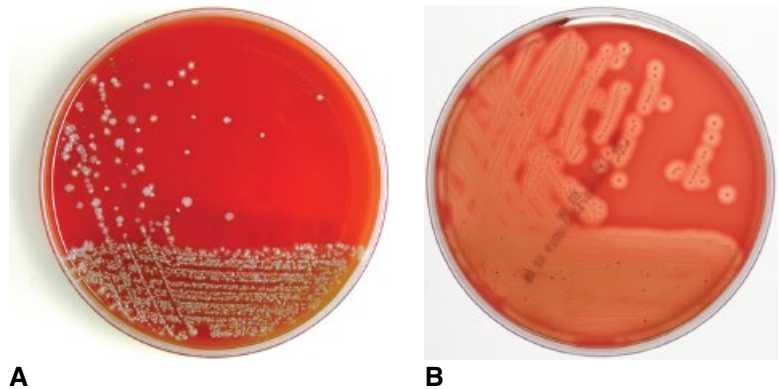


Figure 2-14 Granada agar for the detection of *Streptococcus agalactiae* from clinical specimens. Granada agar with an enrichment broth can be used to directly culture vaginal-anorectal swabs from pregnant females for detection of *S. agalactiae*. After overnight incubation, colonies that appear orange, as shown, can be reported as *S. agalactiae*.

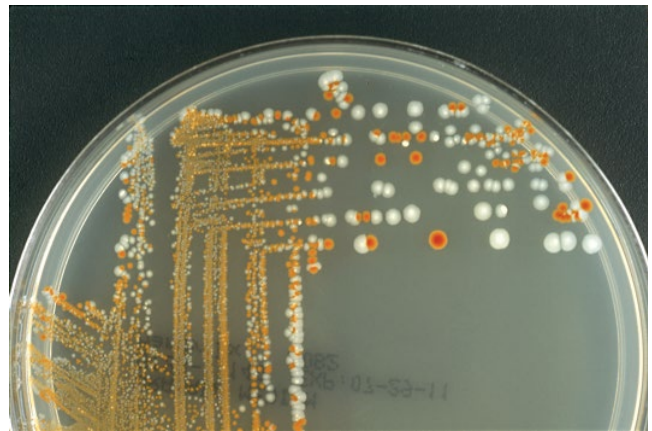


Figure 2-15 Carrot broth for the direct detection of *Streptococcus agalactiae*. Carrot broth can be used to both enrich for and identify *S. agalactiae* (group B streptococcus). Vaginal-anorectal swabs from pregnant females are placed in the broth and incubated overnight. Development of an orange color indicates the presence of *S. agalactiae*. If no orange color develops, yet there is growth in the broth, it is subcultured to rule out the presence of *S. agalactiae*.





Figure 2-16 Bacitracin susceptibility test for the presumptive identification of *Streptococcus pyogenes* (group A streptococcus). The bacitracin susceptibility test is a common test used to presumptively distinguish group A streptococci from other beta-hemolytic streptococci. As shown, a paper disk impregnated with 0.04 U of bacitracin is not able to inhibit the growth of *S. agalactiae* (left), in contrast to *S. pyogenes* (right), which is inhibited from growing up to the bacitracin disk. The formation of any zone of inhibition is considered a positive test. This test is an inexpensive way to identify *S. pyogenes* but is not highly specific or rapid, since 5 to 10% of other beta-hemolytic streptococci can also be inhibited and overnight incubation is required.

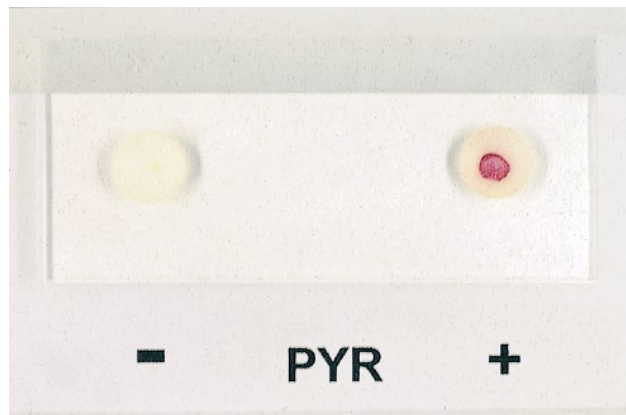
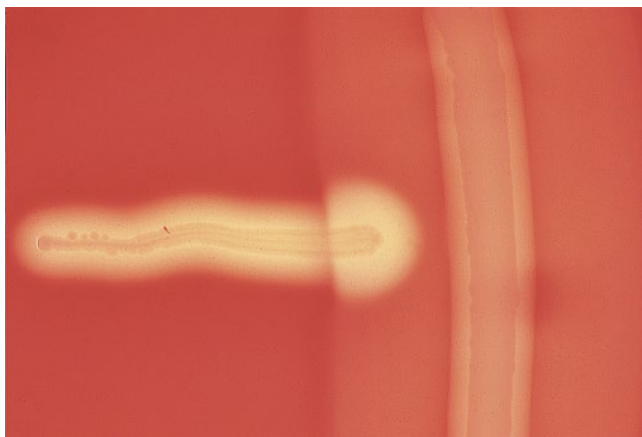


Figure 2-17 PYR test. The PYR test is a rapid, sensitive test for the identification of *S. pyogenes*. Many laboratories have replaced the bacitracin test with the PYR test for the presumptive identification of *S. pyogenes*. To perform this test, the isolate is rubbed onto a paper disk containing L-pyroglutamic acid β -naphthylamide. If the organism possesses the enzyme pyrrolidonyl arylamidase, it is able to degrade the substrate and β -naphthylamide is produced, which can be detected by the addition of *p*-dimethylamino-cinnamaldehyde (the PYR reagent). The isolate on the left is PYR negative, and the one on the right is PYR positive (*S. pyogenes*).

Figure 2-18 CAMP test for the identification of *Streptococcus agalactiae* (group B streptococcus). The CAMP test can be used to presumptively identify *S. agalactiae*. To perform the test, a beta-lysin-producing *Staphylococcus aureus* strain is inoculated in a thin line onto a blood agar plate. The isolate to be identified is inoculated at right angles to the *S. aureus* line, taking care that the two streak lines do not touch. After overnight incubation, if the isolate is *S. agalactiae*, the area of beta-hemolysis where the two organisms have grown in proximity to one another should take the shape of an arrowhead due to the synergistic action of the hemolysins produced by both organisms.



Figure 2-19 CAMP test using a beta-lysins disk. The CAMP test, as shown in Fig. 2-18, can also be performed with disks that have been impregnated with beta-lysins (Thermo Scientific, Remel Products, Lenexa, KS). Here the organism to be identified is inoculated in a straight line within 5 mm of the disk and the culture is incubated overnight. If the isolate is *S. agalactiae*, as shown here, beta-hemolysis can be seen in the shape of a football or a crescent.



Figure 2-20 Hippurate test for the identification of *Streptococcus agalactiae*. As shown, in contrast to other beta-hemolytic streptococci (left), which are hippurate negative, *S. agalactiae* (right) is hippurate positive.



Figure 2-21 Optochin susceptibility for the identification of *Streptococcus pneumoniae*. Growth of *S. pneumoniae* is inhibited in the presence of optochin. Upon inoculation of blood agar with *S. pneumoniae*, a paper disk impregnated with 5 μ g of optochin is placed firmly on the plate. After overnight incubation at 35°C in the presence of 5% CO₂, the formation of a zone of growth inhibition >14 mm in diameter is considered presumptive identification of *S. pneumoniae*.



Figure 2-22 Bile solubility test for the identification of *Streptococcus pneumoniae*. The bile solubility test can be used to differentiate *S. pneumoniae* from other alpha-hemolytic streptococci. Here, colonies of *S. pneumoniae* on blood agar disappear or dissolve when a drop of 2% sodium deoxycholate is placed on the colonies and the plate is incubated for 30 min at 35°C.



Figure 2-23 Production of BGUR. Beta-hemolytic members of the anginosus (*milleri*) group can be confused with streptococci belonging to groups C and G. The BGUR test can help to distinguish between them. In this test, the substrate, methylumbelliferyl- β -D-glucuronide, can be broken down by BGUR to produce a fluorescent compound. As shown here, a heavy inoculum of both an isolate of group C and an isolate belonging to the anginosus group was placed on a MacConkey agar plate containing methylumbelliferyl- β -D-glucuronide (BD Diagnostic Systems, Franklin Lakes, NJ). The plate was incubated for 30 min at 35°C and viewed under long-wave UV light. Fluorescence produced by the group C isolate (upper right quadrant) distinguished it from the nonfluorescent anginosus isolate (lower left quadrant).

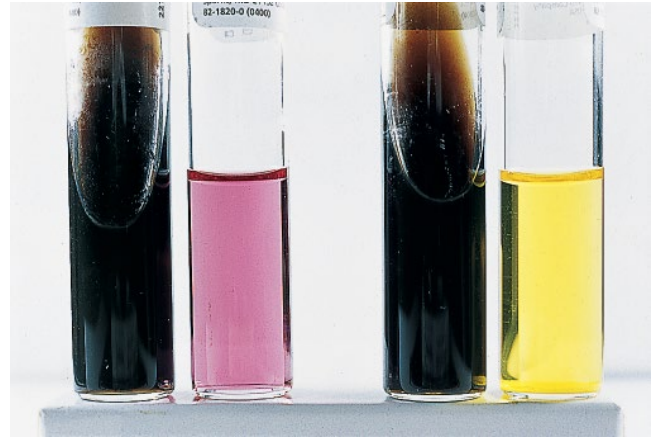


Figure 2-24 Differentiation of the *Streptococcus bovis* group from *Enterococcus faecium*. Bile esculin agar slants and 6.5% salt broth are often used in the differentiation and identification of alpha-hemolytic streptococci. In the example shown here, it can be difficult to distinguish the *S. bovis* group from *E. faecium* because colonies of these two organisms appear similar (Fig. 2-11) and because, when inoculated on a bile esculin slant, both organisms are able to grow in the presence of 40% bile and hydrolyze esculin, which results in blackening of the medium. However, members of the *S. bovis* group (left) are unable to grow in 6.5% salt, unlike *E. faecium* (right) which can grow in the high-salt (6.5%) solution, as demonstrated by the color change of the broth from purple/pink to yellow.

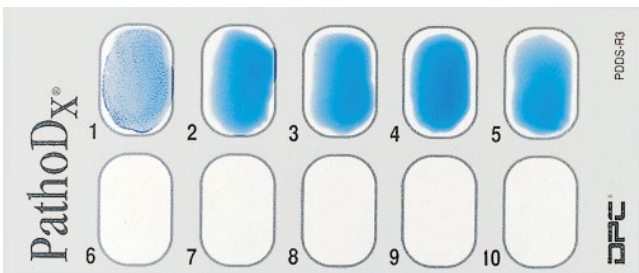


Figure 2-25 Latex agglutination test for the identification of Lancefield groups. Beta-hemolytic streptococci can be grouped on the basis of their Lancefield antigen. A common method to accomplish this involves latex agglutination using monoclonal antibodies coupled to latex particles. In the test shown here (PathoDx; Thermo Scientific Remel Products), a dye is incorporated into the latex reagent to facilitate visualization of the agglutination reaction. Most commercial kits contain reagents for groups A, B, C, E, and G, which are displayed in wells 1 through 5, respectively, in this typing reaction. The isolate shown is *S. pyogenes* (group A streptococcus).



Figure 2-26 RapID STR system for the identification of streptococci. The RapID STR system (Thermo Scientific, Remel Products) utilizes conventional and chromogenic substrates for the identification of streptococci. This system has 10 reaction wells. However, since the last four wells are bifunctional, in that a second reaction can be read when reagents are added to the wells, a total of 14 biochemical reactions are available. Along with the hemolysis reaction of the organisms, this system has the ability to identify most medically relevant streptococci. As with most commercial systems, not all identifications correlate with those obtained by a conventional biochemical battery. In the example shown, the isolate is identified as *S. salivarius*. The test shown in the upper panel was read before the reagents were added to the bifunctional wells as shown in the lower panel.



Figure 2-27 The BactiCard. The BactiCard (Thermo Scientific Remel Products) is a rapid system for the presumptive identification of streptococci. It tests for pyrrolidonyl arylamidase (PYR), leucine arylamidase (LAP), and esculin hydrolysis activity (ESC). Colonies of catalase-negative, Gram-positive cocci are inoculated directly onto the three moistened sections of the strip, which is then incubated for 10 min at room temperature. Examples of typical reaction patterns for the following three organisms are shown: from left to right, group D streptococcus (*S. bovis* group), LAP and ESC positive; *Enterococcus* spp., PYR, LAP, and ESC positive; viridans group streptococci, LAP positive.

Enterococcus

Members of the genus *Enterococcus* are Gram-positive cocci that can survive harsh conditions in nature and thus are ubiquitous, being found in soil, water, and plants. They mainly colonize the gastrointestinal tract but can be found at other sites, such as the genital tracts of humans. At present there are 57 species in this genus. Of these, *Enterococcus faecalis* is the most common species isolated from clinical specimens; however, with the acquisition of more antibiotic resistance, in particular to vancomycin, the isolation of *Enterococcus faecium* is increasing. Less frequently encountered clinical species include *Enterococcus gallinarum*, *Enterococcus casseliflavus*, *Enterococcus avium*, and *Enterococcus raffinosus*. Other enterococcal species are rarely recovered from human specimens.

It is often difficult to establish whether an *Enterococcus* strain is contributing to the infection or is colonizing a site. However, enterococci are now one of the three most common causes of health care-related bloodstream infections and can be the cause of health care-related urinary tract infections. Enterococci also play a role in wound infections and endocarditis. They only rarely cause infections of the central nervous system and respiratory tract. They have been an increasingly important cause of infection in elderly and immunocompromised individuals as well as patients who have been hospitalized on antibiotics for long periods of time.

The ability of enterococci to survive in harsh conditions and produce biofilms has made them difficult to eradicate in the hospital environment. They can live on environmental surfaces and instruments for long

periods of time and resist many standard cleaning regimens. These factors, coupled with the ability to acquire resistance to vancomycin and their intrinsic resistance to aminoglycosides and β -lactam antibiotics, have made enterococci, in particular *E. faecium*, major health care-related pathogens.

In general, enterococcal isolates with reduced susceptibility to vancomycin can be categorized by the resistance gene they carry as *vanA*, *vanB*, and *vanC*; although other genes conferring resistance to vancomycin have been identified, they are less common in a clinical setting. *vanA* and *vanB* strains pose the greatest threat because they are more resistant and the resistance genes are carried on a plasmid or by a transposon and thus are readily transferable. *vanA* isolates, predominantly *E. faecium* and occasionally *E. faecalis* strains, are typically associated with high-level vancomycin resistance, with MICs of ≥ 256 $\mu\text{g/ml}$, and are also resistant to teicoplanin. Strains resistant to vancomycin and carrying the *vanB* gene can have vancomycin MICs that range from moderate to high levels of resistance. The *vanC* strains, predominantly *E. gallinarum* and *E. casseliflavus*, are associated with lower vancomycin MICs, and the resistance appears to be constitutive and chromosomally mediated. *vanC* strains do not seem to contribute to the spread of vancomycin resistance. Occasional enterococcal strains that are vancomycin dependent have been reported. These strains grow only on media that provide a source of vancomycin.

Due to the growing importance of vancomycin-resistant enterococci (VRE), selective and differential media as well as molecular assays have been developed that

have facilitated the rapid detection of these organisms. In certain settings, patients are screened for VRE by obtaining a rectal swab for culture. Selective media, e.g., *Campylobacter* agar, and selective chromogenic media containing vancomycin have been employed to detect these organisms in rectal swabs and feces. There are a number of multiplex DNA-based assays that are able to identify *E. faecium* and *E. faecalis* as well as to detect the *vanA* and *vanB* genes either directly from clinical samples or from positive blood culture bottles. One limitation is the specificity of the direct molecular assays, since some of the *van* genes, e.g., *vanB*, can be found in other genera. Other rapid methods that are used for the identification of enterococci from blood cultures are fluorescence *in situ* hybridization (FISH) and matrix-assisted laser desorption ionization-time of flight mass spectrometry (MALDI-TOF MS).

Enterococci typically are arranged in pairs and short chains; however, under certain growth conditions, they elongate and appear coccobacillary. In general, enterococci are alpha-hemolytic or nonhemolytic; however, depending on the type of blood agar used, they may be beta-hemolytic. Some strains possess the group D

Lancefield antigen and can be detected using monoclonal antibody-based agglutination tests. Enterococci are typically catalase negative, grow over a wide temperature range from 10 to 42°C, and are facultatively anaerobic. Characteristically they are able to grow in 6.5% NaCl, hydrolyze esculin in the presence of 40% bile salts, and are pyrrolidonyl arylamidase and leucine aminopeptidase positive.

While different schemes for identification of enterococcal species have been proposed, the more common enterococcal isolates can be differentiated by a few key biochemical reactions and/or MALDI-TOF MS. Utilization of arabinose, motility, acidification of methyl- α -D-glucopyranoside, and pigment can be used to identify most *E. faecalis*, *E. faecium*, *E. gallinarum*, and *E. casseliflavus* strains to the species level. Addition of sorbose and raffinose allows identification of the less frequently isolated species *E. avium* and *E. raffinosus*. Commercial identification systems to differentiate among the species are available. While these systems can identify the more frequently isolated species, they are not as reliable with the less common isolates.

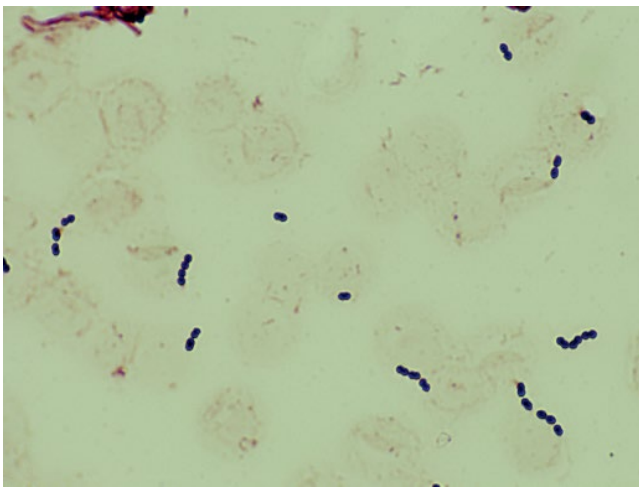


Figure 3-1 Gram stain of *Enterococcus faecium*. Shown is *E. faecium* obtained from a blood culture. This organism is a Gram-positive coccus that occurs in pairs and short chains.



Figure 3-2 *Enterococcus faecalis* and *Enterococcus faecium* on sheep blood agar. *E. faecalis* (left) forms a non-hemolytic, flat, gray colony with a smooth, translucent edge. In comparison, colonies of *E. faecium* (right) are surrounded by a small zone of alpha-hemolysis and have a defined opaque edge.

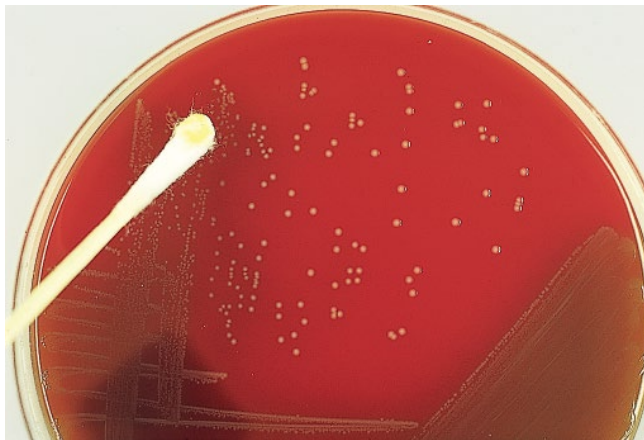


Figure 3-3 *Enterococcus casseliflavus* on blood agar. The typical yellow pigment of *E. casseliflavus* is most easily seen by picking up colonies with a cotton swab.

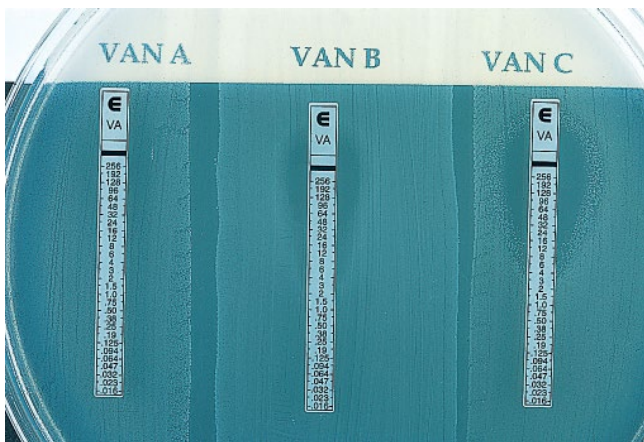


Figure 3-4 Comparison of vancomycin susceptibility of *vanA*, *vanB*, and *vanC* *Enterococcus* strains. In general, the E-test can be used to categorize enterococci into three main groups, *vanA*, *vanB*, and *vanC*, based on the vancomycin MIC. The *vanA* phenotype (left) shown here is an *E. faecium* isolate with a high level of resistance to vancomycin. The *vanB* strain (center) is an *E. faecalis* isolate for which the vancomycin MIC is 32 µg/ml. The *vanC* strain (right) is an *E. gallinarum* isolate for which the vancomycin MIC is 16 µg/ml.



Figure 3-5 Vancomycin-dependent *Enterococcus faecalis* strain. This strain, isolated from a rectal culture, initially grew on *Campylobacter* medium containing 10 µg of vancomycin per ml but upon subculture failed to grow on sheep blood agar. As seen here, the vancomycin (30 µg) in the disk supports the growth of this isolate on blood agar.

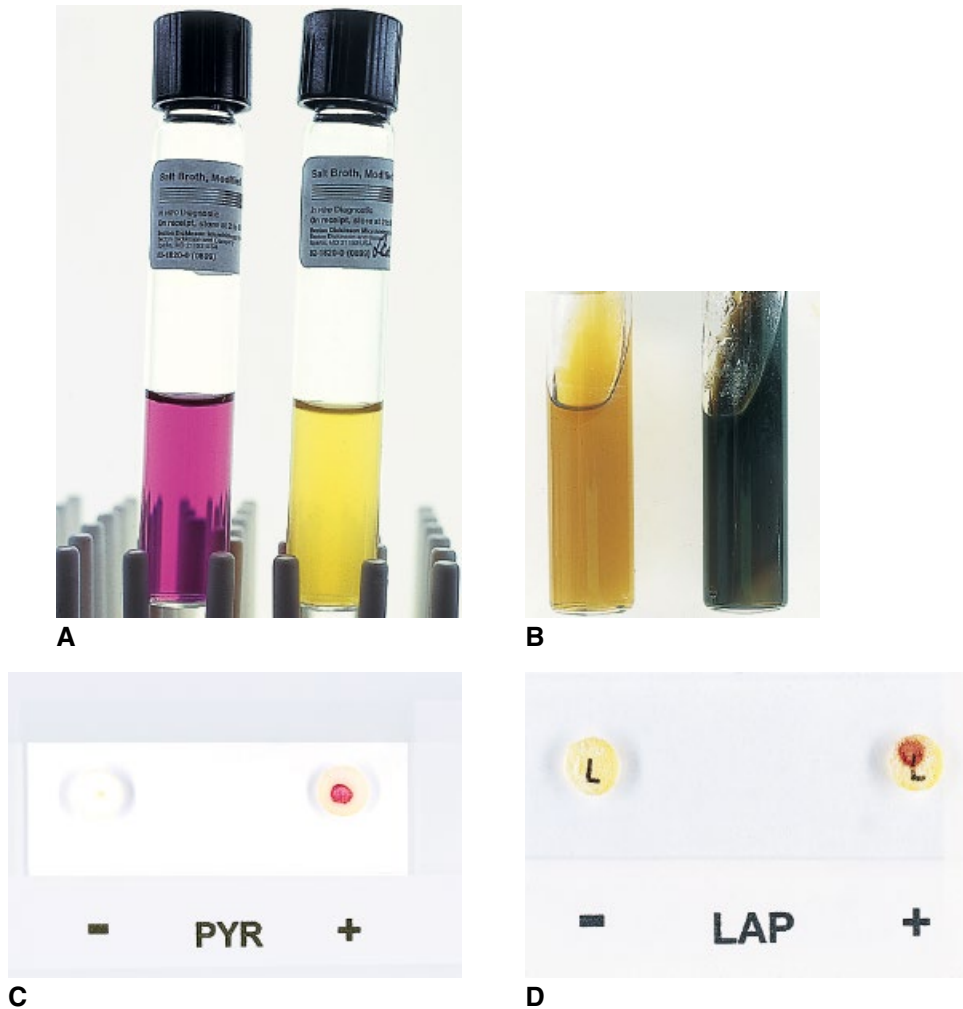


Figure 3-6 Biochemicals used to identify *Enterococcus* spp. A typical biochemical profile of the genus *Enterococcus* is growth in the presence of 6.5% NaCl (A), growth on medium containing 40% bile salts and the ability to hydrolyze esculin (B), a positive pyrrolidonyl arylamidase (PYR) test (C), and a positive leucine aminopeptidase (LAP) test (D). A nonenterococcal isolate negative for each reaction is shown on the left, and the positive reactions typical of *Enterococcus* spp. are shown on the right.

Figure 3-7 Arabinose utilization. Arabinose utilization can be used to separate *E. faecalis* from *E. faecium*. Brain heart infusion broth containing arabinose with a bromocresol purple indicator was inoculated with *E. faecalis* (left) and *E. faecium* (right). A negative reaction, with *E. faecalis*, is the original purple color of the medium and a positive reaction, as seen here with *E. faecium*, is yellow.



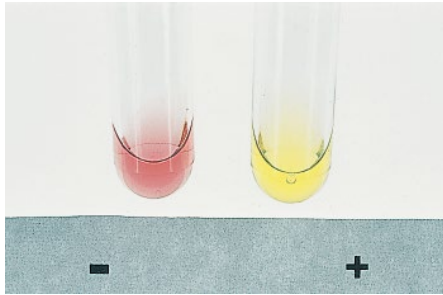


Figure 3-8 Acidification of methyl- α -D-glucopyranoside. A test that can distinguish *E. faecium* from *E. gallinarum* and *E. casseliflavus* is acidification of 1% methyl- α -D-glucopyranoside. *E. faecium* (left) does not utilize this compound, as demonstrated by the lack of change of color of the phenol red indicator. The other two species can utilize this compound, as illustrated by the yellow color of the broth inoculated with *E. gallinarum* (right), indicating acidification of the medium. The broths were incubated overnight at 35°C.



Figure 3-9 Motility as a test for the identification of *Enterococcus*. Motility is a common test used to differentiate *E. casseliflavus* and *E. gallinarum* from other common clinical isolates of *Enterococcus*, namely, *E. faecium* and *E. faecalis*. As shown here, *E. faecium* (left) is nonmotile while *E. gallinarum* (right) is motile. The motility agar shown incorporates triphenyltetrazolium chloride, which facilitates the interpretation of this test.

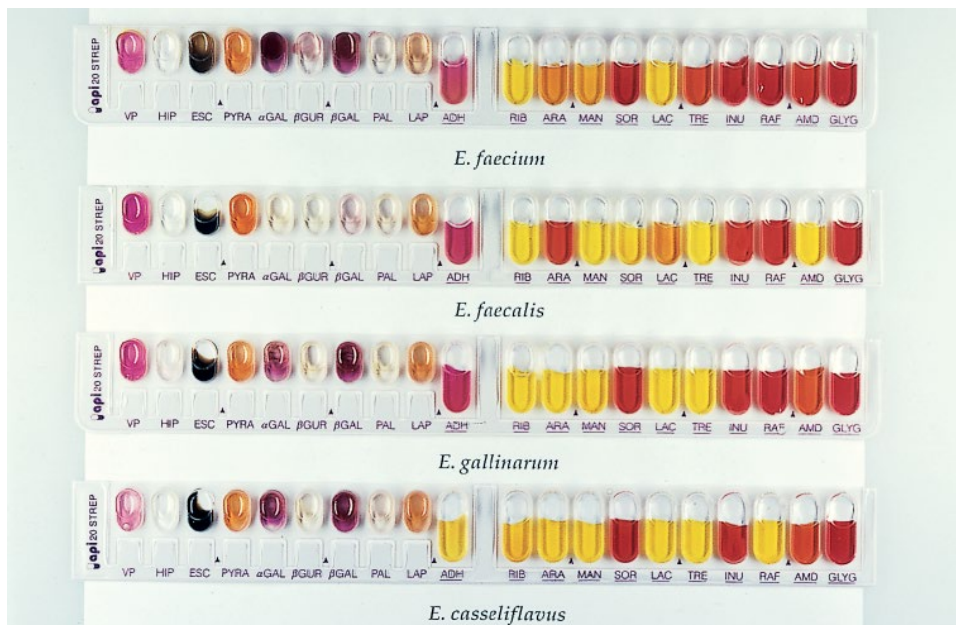


Figure 3-10 Identification of enterococci by the API 20 Strep test. Kits for the identification of streptococci can be used to differentiate the more common enterococcal isolates. Shown here are four species of *Enterococcus* inoculated into API 20 Strep strips (bioMérieux, Inc., Durham, NC).

Figure 3-11 Simplified algorithm for identification of the more common clinical isolates of enterococci. Reactions with some of the biochemicals and tests may vary, depending on the species and strain.

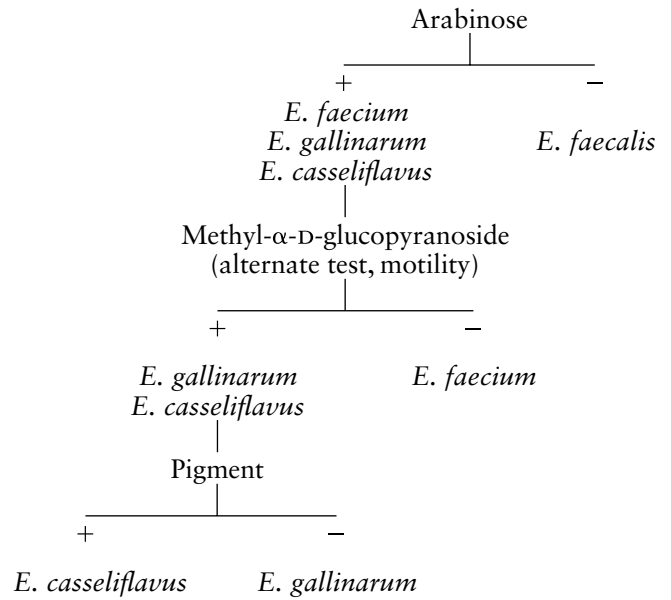
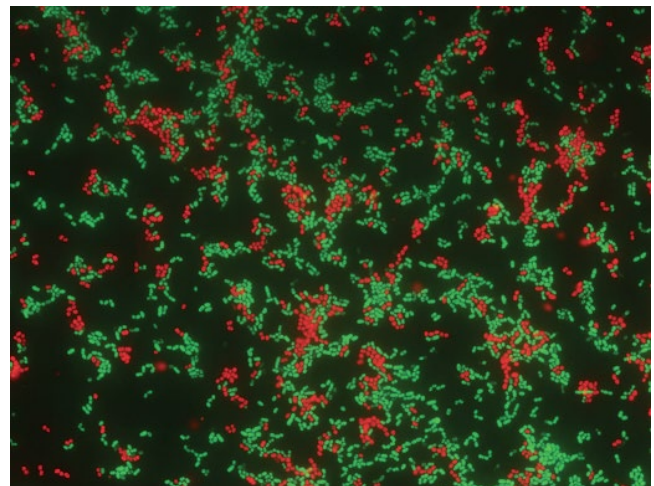


Figure 3-12 Peptide nucleic acid (PNA) FISH for the direct identification of *Enterococcus*. A blood culture positive for Gram-positive cocci in short chains and pairs was tested by PNA FISH (Enterococcus AdvanDx; OpGen, Inc., Gaithersburg, MD). This is a 90-min FISH assay that utilizes fluorescence-labeled PNA. PNA FISH can detect *E. faecalis* (green) and *E. faecium* as well as other *Enterococcus* spp. (red). These probes target the species-specific rRNA in these organisms and can easily penetrate the bacterial cell wall and membrane. Shown is a mixed culture positive for both *E. faecalis* (green) and *E. faecium* (red). (Photo courtesy of AdvanDx.)



Aerococcus, Abiotrophia, and Other Miscellaneous Gram-Positive Cocci That Grow Aerobically

4

The organisms discussed in this chapter are catalase-negative, Gram-positive cocci that can be found as members of the normal microbiota throughout the body and that, for the most part, cause opportunistic infections. They resemble, and as a result can be misidentified as, staphylococci and streptococci because of their microscopic and culture characteristics. In certain instances, they are recognized only when presumptive streptococci are found to be resistant to vancomycin. The genera and species that are microscopically similar to *Staphylococcus* are *Aerococcus*, *Dolosigranulum*, *Gemella haemolysans*, *Helcococcus*, and *Pediococcus*. Those that resemble *Streptococcus* include *Abiotrophia*, *Dolosicoccus*, *Facklamia*, *Gemella* spp. other than *G. haemolysans*, *Globicatella*, *Granulicatella*, *Ignavigranum*, *Lactococcus*, *Leuconostoc*, *Vagococcus*, and *Weissella*. *Globicatella*, *Facklamia*, *Ignavigranum*, and *Dolosicoccus* are related genera that are infrequently isolated from clinical specimens.

The genus *Lactococcus* is composed of nonmotile organisms previously classified as Lancefield group N streptococci. *Lactococcus lactis* and *Lactococcus garvieae* are known to cause infections in humans. However, the motile *Lactococcus*-like organisms with Lancefield group N antigen belong to the genus *Vagococcus*, which resembles *Enterococcus*. Organisms previously classified as nutritionally deficient or satellite streptococci are in the genera *Abiotrophia* and *Granulicatella*.

Although these organisms have low virulence, they can cause infections in immunocompromised patients. Infections usually occur following prolonged hospitalization, invasive procedures, damage to tissues, entry of

foreign bodies, and antimicrobial therapy. *Aerococcus*, *Abiotrophia*, *Gemella*, *Granulicatella*, *Pediococcus*, *Globicatella*, *Lactococcus*, *Leuconostoc*, and *Weissella* have been isolated from patients with bacteremia and/or endocarditis, while *Helcococcus* has been isolated from wound cultures of the lower extremities, e.g., foot ulcers. *Abiotrophia* and *Granulicatella* are recognized as agents of endocarditis involving both native and prosthetic valves. *Weissella confusa*, formerly classified as *Lactobacillus confusus*, has been reported infrequently as an agent of bacteremia and endocarditis. *Vagococcus* has been isolated from blood, peritoneal fluid, and wounds.

Aerococcus urinae has been implicated in urinary tract infections, primarily in the elderly, and can cause lymphadenitis, endocarditis, and peritonitis. *Aerococcus sanguinicola* and *Aerococcus urinaehominis* have also been isolated from urine.

As expected, the *Staphylococcus*-like organisms appear in pairs, tetrads, and clusters and the *Streptococcus*-like bacteria are arranged in pairs and chains. However, *Gemella* can appear Gram variable or Gram negative, and *Abiotrophia*, along with *Granulicatella*, may form coccobacilli in pairs and chains or may be pleomorphic if grown on nutritionally deficient media. Microscopic morphologic assessment should be made from cells grown in a broth medium such as thioglycolate.

These organisms are facultative anaerobes with the exception of *Aerococcus viridans*, which is microaerophilic because it grows poorly or not at all under anaerobic conditions. Most of these organisms grow well on chocolate or blood agar and in thioglycolate broth;

the exceptions are *Abiotrophia* and *Granulicatella*. A test for satellitism is important for identification of these two genera. The organism is inoculated for confluent growth onto sheep blood agar. A single cross streak of *Staphylococcus aureus* (ATCC 25923) is applied to the inoculated area. Following incubation at 35°C in CO₂, strains of *Abiotrophia* and *Granulicatella* grow only in the area of staphylococcal growth. Alternatively, media can be supplemented with pyridoxal, which can be supplied in the form of a disk. Some strains of *Ignavigranum* may also demonstrate satellitism. *Helcococcus* grows slowly, requiring 48 to 72 h of incubation before visible colonies can be detected. These organisms grow best when incubated anaerobically, and growth is stimulated by addition of 1% horse blood or 0.1% Tween 80 to the medium. Thayer-Martin medium may be used for the selective isolation of pyrrolidonyl aminopeptidase (pyrrolidonyl arylamidase [PYR])-negative, vancomycin-resistant *Leuconostoc*, *Pediococcus*, and *Weissella* strains. Growth temperature characteristics are also important in differentiating *Lactococcus* from streptococci and enterococci. *Lactococcus* grows

at 10 and 35°C, streptococci grow at 35°C, although some streptococci grow at 45°C, while enterococci grow at all three temperatures.

A few key tests that aid in the identification of these organisms include catalase production, esculin hydrolysis, growth in 6.5% NaCl, leucine aminopeptidase (LAP) and PYR production, and vancomycin susceptibility (Table 4-1). While most of these organisms are catalase negative and PYR positive, *A. viridans* may have a weak catalase-positive reaction, and *Aerococcus*, *Pediococcus*, *Leuconostoc*, and some strains of *Lactococcus* are PYR negative. LAP-negative genera include *Dolosicoccus*, *Globicatella*, *Helcococcus*, and *Leuconostoc*. Two species of *Aerococcus*, *A. urinaehominis* and *A. viridans*, are also LAP negative.

Commercial identification kits and automated methods are available, although their accuracy is limited. However, they do provide phenotypic information which can be used in combination with the basic tests described above and in Table 4-1. Identification by sequence-based techniques (16S rRNA) is more accurate than by the phenotypic methods for many of these infrequently isolated organisms.

Table 4-1 Identification of miscellaneous Gram-positive cocci that grow aerobically and have catalase-negative or weak reactions^a

Organism	Esculin hydrolysis	LAP	PYR	Growth in 6.5% NaCl	VAN
<i>Abiotrophia</i>	V	+	+	0	S
<i>Aerococcus viridans</i> ^b	+	0	+	+	S
<i>Aerococcus christensenii</i>	0	0	0	+	S
<i>Aerococcus sanguinicola</i>	+	+	+	+	S
<i>Aerococcus urinae</i>	V	+	0	+	S
<i>Aerococcus urinaehominis</i>	+	0	0	+	S
<i>Dolosicoccus</i>	0	0	+	0	S
<i>Dolosigranulum</i>	+	+	+	+	S
<i>Facklamia</i>	0	+	+	+	S
<i>Gemella</i>	0	+	+	0	S
<i>Globicatella</i>	+	0	V	+	S
<i>Granulicatella</i>	ND	+	+	0	S
<i>Helcococcus</i>	+	0	+	V	S
<i>Ignavigranum</i>	0	+	+	+	S
<i>Lactococcus</i>	+	+	V	V	S
<i>Leuconostoc</i>	V	0	0	+	R
<i>Pediococcus</i>	V	+	0	V	R
<i>Vagococcus</i>	+	+	+	V	S
<i>Weissella</i>	V	0	0	+	R

^aLAP, leucine aminopeptidase production; PYR, pyrrolidonyl aminopeptidase (pyrrolidonyl arylamidase) production; VAN, vancomycin susceptibility; +, positive; V, variable reaction; 0, negative; S, susceptible; R, resistant; ND, no data.

^bRare strains may be weakly catalase positive.

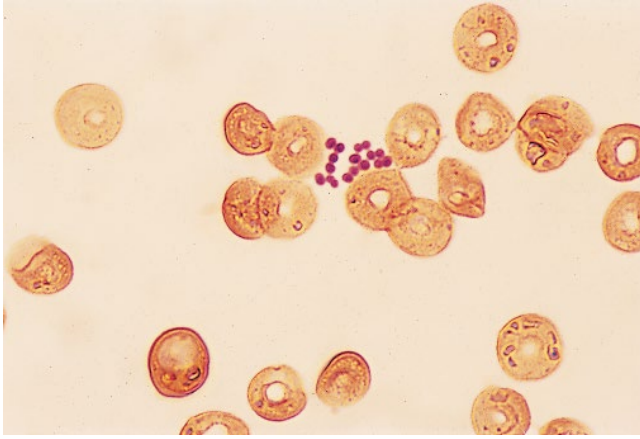


Figure 4-1 Gram stain of *Aerococcus viridans* from a blood culture. Microscopically, *Aerococcus* strains resemble staphylococci, appearing as Gram-positive cocci measuring approximately 1.0 to 2.0 μm in diameter. They are usually arranged in pairs, as shown here, or in tetrads when grown in liquid media.

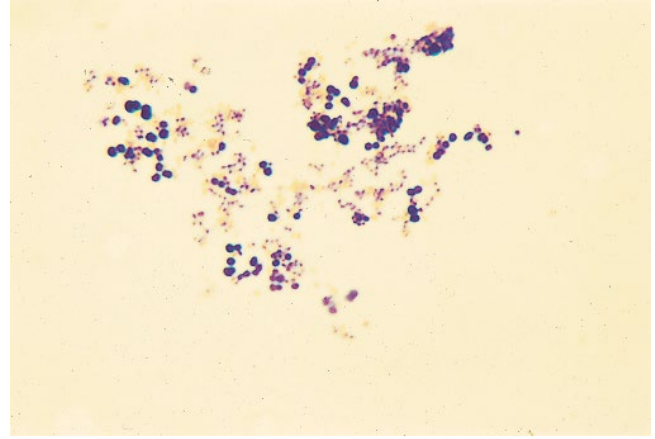


Figure 4-2 Gram stain of *Gemella*. Cells of *Gemella* can be spherical or elongated, measuring 0.5 to 0.8 μm by 0.5 to 1.4 μm . However, *G. haemolysans*, originally classified as *Neisseria* species due to its Gram-variable or Gram-negative nature, usually appears as diplococci that occur in pairs with adjacent flattened sides.

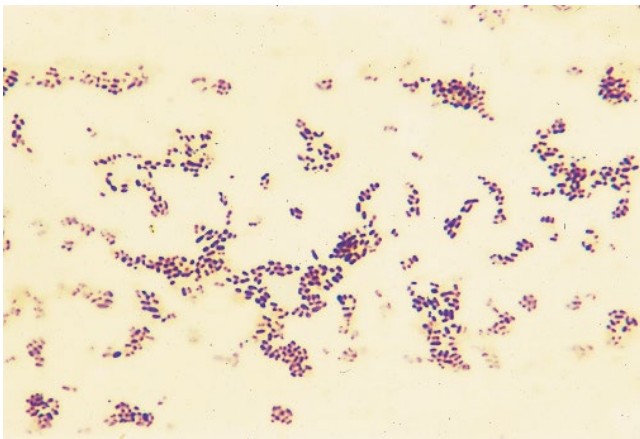


Figure 4-3 Gram stain of *Leuconostoc*. *Leuconostoc* cells are coccoid or coccobacillary with rounded ends, measuring 0.5 to 0.7 μm by 0.7 to 1.2 μm , and can form pairs and chains.

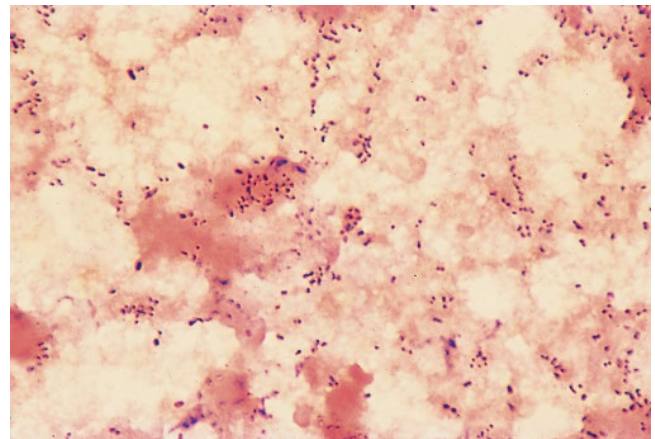


Figure 4-4 Gram stain of *Abiotrophia*. Microscopically, *Abiotrophia* spp. are tiny cocci or coccobacilli, measuring approximately 0.1 to 0.2 μm in diameter, arranged in pairs and/or long chains.

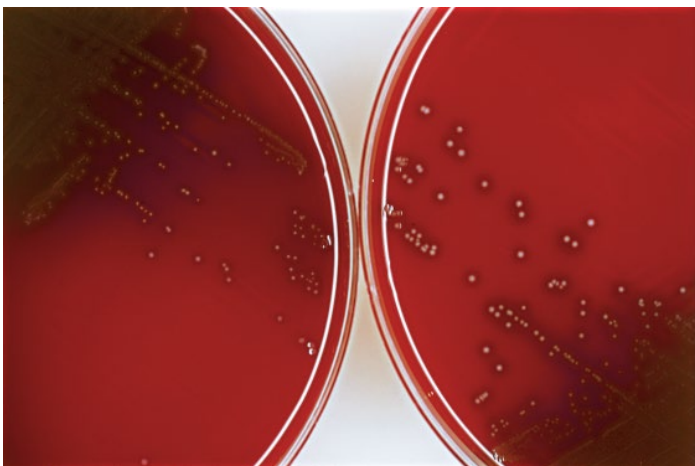


Figure 4-5 *Aerococcus urinae* and *Aerococcus viridans* on blood agar. Colonies of *A. urinae* (left) and *A. viridans* (right) are similar: they are alpha-hemolytic, measure 1.0 to 2.0 mm in diameter, and can be confused on blood agar with those of the viridans streptococci and, microscopically, with staphylococci, as shown in Fig. 4-1. These organisms are microaerophilic, and most strains do not grow when incubated anaerobically, while others grow poorly in air. Optimal growth occurs under reduced oxygen tension.

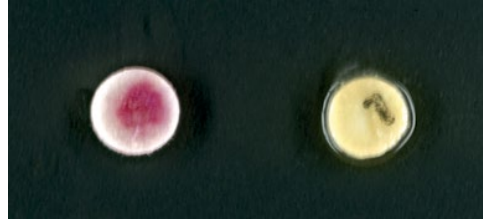


Figure 4-6 Production of PYR and LAP by *Aerococcus urinae* and *Aerococcus viridans*. *A. urinae* and *A. viridans* can be differentiated based on PYR (left) and LAP (right) reactions. *A. viridans* is PYR positive and LAP negative, as shown in this figure, while *A. urinae* is PYR negative and LAP positive (not shown).



Figure 4-7 *Streptococcus bovis*, *Enterococcus faecalis*, and *Aerococcus urinae* on bile-esculin agar slants and in 6.5% NaCl broth. *S. bovis* (tubes on the left), *E. faecalis* (tubes in the center), and *A. urinae* (tubes on the right) may be differentiated based on their reactions on bile-esculin agar and in 6.5% NaCl broth. As shown here, *S. bovis* grows in the presence of 40% bile and hydrolyzes esculin, as indicated by the blackening of the slant, but does not grow in 6.5% NaCl, while *E. faecalis* is positive in both media. A positive reaction in the 6.5% NaCl broth is indicated by growth or turbidity and a color change from purple to yellow. The reaction of *A. urinae* on bile-esculin agar can vary. In this example, *A. urinae* did not hydrolyze esculin; however, it did grow in the 6.5% NaCl broth.

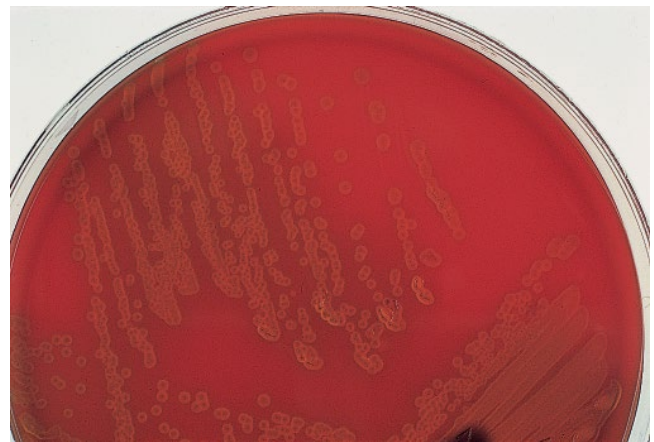


Figure 4-8 *Leuconostoc* on blood agar. Colonies of *Leuconostoc* spp. are alpha-hemolytic and small, measuring 1.0 to 2.0 mm in diameter, and can be confused with those of viridans group streptococci.

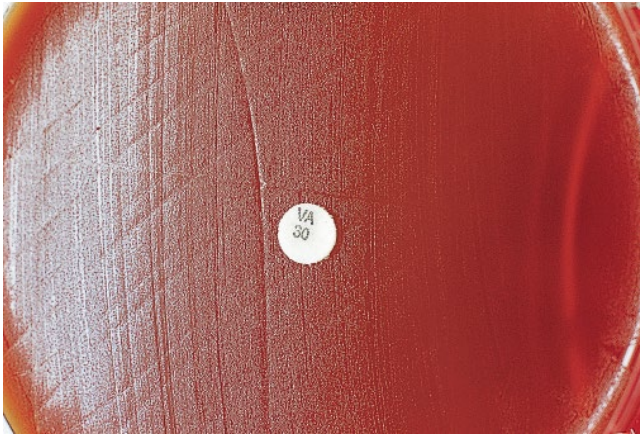


Figure 4-9 Vancomycin-resistant *Leuconostoc* on blood agar. Vancomycin resistance is used to differentiate *Leuconostoc* spp. from the viridans streptococci. A heavy inoculum of the organism is spread over blood agar, and a 30- μ g vancomycin disk is placed in the center of the inoculum. The plate is incubated overnight at 35°C in CO₂. Any zone of inhibition indicates susceptibility, while resistant strains exhibit no zone of inhibition, as shown in this figure. Other vancomycin-resistant, catalase-negative, Gram-positive cocci include *Pediococcus* and vancomycin-resistant strains of *Enterococcus*.



Figure 4-10 Gas production from glucose by *Leuconostoc*. Gas production from the fermentation of glucose is used to differentiate *Leuconostoc* spp. from other vancomycin-resistant organisms. In this example, *Pediococcus* was inoculated into the glucose broth on the left and *Leuconostoc* was inoculated into the tube on the right. No gas appears in the tube on the left, while there is gas in the top half of the tube inoculated with *Leuconostoc*. *Weissella* also produces gas and can be confused with *Leuconostoc*. The difference is that *Leuconostoc* is arginine negative, while *Weissella* hydrolyzes arginine.



Figure 4-11 *Gemella* on blood agar. Colonies of *Gemella* spp. are alpha-hemolytic and small, measuring approximately 1.0 mm in diameter, and can be confused with those of viridans group streptococci. Some strains may be beta-hemolytic. The colonies are also similar to those of *A. viridans* and *Leuconostoc*, although they are slightly smaller and may grow more slowly.

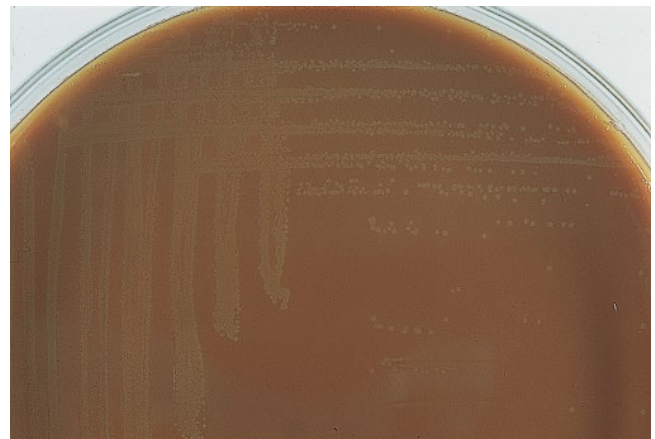


Figure 4-12 *Abiotrophia* on chocolate agar. Colonies of *Abiotrophia* are small, measuring 1.0 mm in diameter, are either alpha-hemolytic or nonhemolytic, and can be confused with those of viridans group streptococci. *Abiotrophia* grows on chocolate agar, as shown here, but does not grow on blood agar unless the medium is supplemented with pyridoxal or an inoculum of *S. aureus*, as shown in Fig. 4-13.

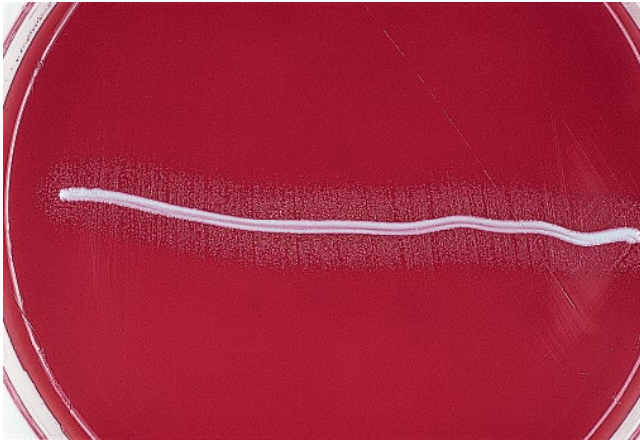


Figure 4-13 Satellite growth of *Abiotrophia* on blood agar. Colonies of *Abiotrophia*, formerly known as nutritionally variant streptococci, form satellite growth around a beta-hemolytic strain of *S. aureus* when grown on a medium that otherwise fails to support its growth. To perform this test, colonies of *Abiotrophia* are inoculated over the surface of the medium and *S. aureus* is then inoculated in a single streak, as shown here. After incubation at 35°C in the presence of CO₂, colonies of *Abiotrophia* grow only in the area surrounding the staphylococcal streak.

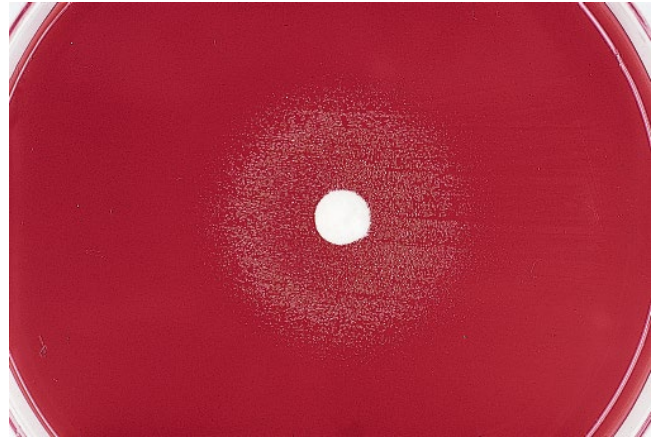


Figure 4-14 Satellite growth of *Abiotrophia* on blood agar containing pyridoxal. An alternate method for demonstrating satellitism by *Abiotrophia* involves supplementing the medium with 0.001% pyridoxal. This can be done by using an aqueous solution of pyridoxal hydrochloride or applying a disk containing the reagent, as shown here. Growth occurs only in the area surrounding the disk into which pyridoxal has diffused.

Coryneform Gram-Positive Bacilli

The organisms discussed in this chapter include aerobic, Gram-positive, non-spore-forming, irregularly shaped bacilli called coryneforms. The term “coryneform” is derived from the Greek word *coryne*, meaning “club.” Although the *Corynebacterium* spp. are the only true club-shaped bacteria, the other genera may have irregular morphologies as well. The more common such genera include *Corynebacterium*, *Arcanobacterium*, *Rothia*, and *Gardnerella*. The anaerobic coryneform Gram-positive bacilli are discussed in chapter 29, including *Actinomyces*, *Actinobaculum*, *Bifidobacterium*, and *Propionibacterium* (*Cutibacterium*). There are several less frequently isolated genera, and in general, they are usually acquired from the environment or are part of the indigenous bacterial microbiota of humans. Their pathogenic potential appears to be low. However, coryneform bacteria should be identified to the species level if they are isolated from normally sterile body sites, from adequately collected clinical material if they are predominant organisms, or from urine if they are isolated in pure culture at $>10^4$ CFU/ml or are the predominant organisms with a total count of 10^5 CFU/ml. The clinical significance of these organisms is strengthened if they are isolated from multiple specimens and if they are observed on a direct Gram stain along with leukocytes. Human infections with *Corynebacterium* spp. range from community-acquired infections, such as conjunctivitis, pharyngitis, genitourinary tract infections, and skin and soft tissue infections, to health care-related infections, such as cerebrospinal fluid shunt infections, pneumonia, and orthopedic, intravenous catheter-related, postsurgical, peritoneal dialysis-related, and urinary tract infections.

The species most likely to be encountered in the clinical laboratory are the opportunistic pathogens, along with *Corynebacterium diphtheriae*, the causative agent of diphtheria. However, *Corynebacterium ulcerans* and *Corynebacterium pseudotuberculosis* may also harbor the bacteriophage that carries the diphtheria *tox* gene and may have the potential to produce diphtheria toxin. Some of the more medically relevant organisms in the genus *Corynebacterium* are *Corynebacterium amycolatum*, *Corynebacterium aurimucosum*, *Corynebacterium coyleae*, *C. diphtheriae*, *Corynebacterium glucuronolyticum*, *Corynebacterium jeikeium*, *Corynebacterium kroppenstedtii*, *Corynebacterium macginleyi*, *Corynebacterium propinquum*, *Corynebacterium pseudodiphtheriticum*, *C. pseudotuberculosis*, *Corynebacterium riegelii*, *Corynebacterium resistens*, *Corynebacterium simulans*, *Corynebacterium striatum*, *C. ulcerans*, and *Corynebacterium urealyticum*.

The more common *Corynebacterium* spp. causing infections in humans are *C. jeikeium*, *C. striatum*, and *C. urealyticum*. *C. jeikeium*, one of the species most commonly isolated from clinical specimens, is known to cause bacteremia and prosthetic valve endocarditis. Infections are also seen in immunocompromised hosts with hematologic and solid organ malignancies, indwelling medical devices, and health care-related bacteremia and sepsis. This species is often resistant to multiple antibiotics. *C. striatum*, an emerging health care-related pathogen, is associated with several infections in humans, including prosthetic device endocarditis, sepsis and bacteremia in immunocompromised patients, respiratory tract

infections, osteomyelitis, meningitis, and wound infections. It is also a multidrug-resistant pathogen causing high mortality. *C. urealyticum* is usually isolated from urine specimens with an alkaline pH and is associated with struvite crystals known as alkaline-encrusted cystitis. This organism is often resistant to multiple antibiotics.

Other coryneform bacteria of importance are *Arcanobacterium haemolyticum*, *Gardnerella vaginalis*, and *Rothia dentocariosa*. *A. haemolyticum* has been associated with pharyngitis in older children, wound and soft tissue infections, endocarditis, and osteomyelitis. *G. vaginalis* is part of the anorectal microbiota of humans as well as the vaginal microbiota of women and is one of the organisms associated with bacterial vaginosis. *R. dentocariosa* is part of the normal microbiota of the oropharyngeal cavity of humans and has been associated with dental caries and periodontal disease, as well as with endocarditis and pneumonia in immunodeficient hosts.

Other medically relevant coryneform bacteria are *Arthrobacter*, *Brevibacterium* spp., *Cellulomonas* spp., *Cellulosimicrobium* spp., *Dermabacter hominis*, *Microbacterium* spp., *Rothia mucilaginosa*, *Trueperella bernardiae*, *Trueperella pyogenes*, and *Turicella otitidis*. Clinical infections and characteristics of the aerobic coryneform bacteria are described in Table 5-1. Microscopically, the coryneform bacteria vary in shape and size, ranging from coccoid forms approximately 0.5 to 2 μm in diameter to definite rod forms up to 6 μm long. They often stain unevenly with the Gram stain. The arrangement of cells is characteristic of the corynebacteria. They have been described as V forms and bacilli in a parallel or palisade formation, and some may also branch.

With few exceptions, the frequently isolated, medically relevant coryneform bacteria grow at 37°C within 48 h in a CO₂-enriched atmosphere. Broth media should be incubated for 5 days. Slow-growing *Corynebacterium* spp. can cause urinary tract infections, and therefore, for symptomatic patients (e.g., the elderly and those with urinary catheters or with struvite crystals), the urine culture should be held for 48 h.

A variety of carbohydrates and other tests can be used to identify the various corynebacteria (Table 5-2). Some important tests for identification include those for catalase, oxidation-fermentation in cystine Trypticase agar medium, motility, nitrate reduction, esculin production, urea hydrolysis, and acid production from glucose, maltose, sucrose, mannitol, and xylose. API Coryne (bioMérieux, Inc., Durham, NC) and RapID CB Plus (Thermo Scientific, Remel Products, Lenexa, KS) are two examples of commercial systems for the identification of the

coryneform bacteria. Although these phenotypic tests may identify many of the coryneform bacteria accurately, it may be necessary to use other tests, such as matrix-assisted laser desorption ionization-time of flight mass spectroscopy (MALDI-TOF MS) and, in some cases, molecular assays, e.g., 16S rRNA gene sequencing.

C. diphtheriae is the most pathogenic of the corynebacteria. The diagnosis is usually based on clinical symptoms followed by culture confirmation. The preferred specimen is a nasopharyngeal swab. It is important to inoculate blood agar when suspected cases of diphtheria are being investigated, although it is difficult to distinguish *C. diphtheriae* from other corynebacteria. Although corynebacteria grow on blood agar, a selective medium, such as tellurite medium (Tinsdale or cystine-tellurite blood agar), should be inoculated if *C. diphtheriae* is suspected. *C. diphtheriae* can easily be distinguished from other corynebacteria on tellurite-containing agar by the brown halo surrounding the black colonies, an important differentiating characteristic. However, if the strain is sensitive to potassium tellurite, it may not grow on tellurite-containing medium but will grow on blood agar. Even though Loeffler's serum medium is no longer recommended for primary plating because many organisms grow on it and it is difficult to distinguish the corynebacteria, it is the preferred medium to demonstrate the presence of metachromatic granules, which are characteristic of *C. diphtheriae*.

The toxigenicity test is an important method to determine the pathogenicity of *C. diphtheriae*. The *in vitro* diphtheria antitoxin test, also known as the modified Elek method, is useful and is usually performed by reference laboratories. Commercially available antitoxins applied to blank filter paper disks at 10 IU/disk have been successfully used with the modified Elek test, and precipitin lines can be read as early as 24 h. With the development of PCR-based methods for detection of the diphtheria toxin gene (*tox*), another option is to initiate a real-time PCR-based test for *tox* gene detection whenever an identification method is positive for *C. diphtheriae*, *C. pseudotuberculosis*, or *C. ulcerans*. This test is usually performed by reference laboratories. PCR-positive results should be followed by Elek testing.

Since other corynebacteria cause infections in humans, *Corynebacterium* spp. other than *C. diphtheriae* should be considered probable pathogens. They should be identified to the species level if they are isolated from adequately collected specimens obtained from normally sterile sites, if multiple specimens are positive, or if they appear in the direct Gram stain with leukocytes.

Table 5-1 Clinical infections and characteristics of coryneform bacteria^a

Species	Clinical source and types of infections	Characteristics
<i>Corynebacterium</i> species		
<i>C. amycolatum</i>	Normal microbiota of the skin; bacteremia, wound infections, urinary and respiratory tract infections, foreign body-mediated infections	Colonies are 1–2 mm in diameter, dry, waxy, and grayish white with irregular edges after 24 h of incubation; can be misidentified as <i>C. striatum</i> or <i>C. xerosis</i> because of their variable biochemical reactions
<i>C. aurimucosum</i>	Sterile body fluids, female genitourinary tract; prosthetic joint infections, urinary tract infections	Colonies may appear slightly yellow and sticky on 5% sheep blood agar but colorless on Trypticase soy agar without blood; some strains may exhibit a grayish black pigment, not seen with other corynebacteria; the colonial morphology of <i>C. minutissimum</i> is similar to that of <i>C. aurimucosum</i> and the two species are difficult to distinguish by MALDI-TOF MS and 16S rRNA gene sequencing.
<i>C. coyleae</i>	Blood, sterile body fluids, abscesses, urogenital tract	Colonies are 1 mm in diameter, whitish, creamy, sticky, and glistening after 24 h of incubation; has a strong positive CAMP reaction; ferments sugars slowly
<i>C. diphtheriae</i>	Respiratory tract and skin; endocarditis among the homeless, alcohol and drug abusers	Four <i>C. diphtheriae</i> biotypes: belfanti, gravis, intermedium, and mitis; colonies vary based on the biotype; on selective media enhanced with tellurite, e.g., freshly prepared Tinsdale agar, colonies appear black with a black halo, a characteristic of <i>C. diphtheriae</i> .
<i>C. glucuronolyticum</i>	Prostate and urogenital tracts of symptomatic males; granulomatous mastitis in males, blood infection	Colonies are 1.0–1.5 mm in diameter, whitish-yellow, convex, and creamy at 24 h; rapid urea positive (5 min) if urease is present; CAMP positive; one of few <i>Corynebacterium</i> spp. exhibiting β-glucuronidase activity
<i>C. jeikeium</i>	Bacteremia, endocarditis; prosthetic devices, heart valve, bone marrow, bile, wounds; urinary tract infections	Strict aerobe with tiny grayish-white colonies; can be slow growing, requiring 48 h of incubation; lipophilic; growth is enhanced when blood agar is supplemented with Tween 80; oxidizes glucose and sometimes maltose
<i>C. kroppenstedtii</i>	Lower respiratory tract; infects patients with pulmonary disease; granulomatous mastitis in women of reproductive age	Colonies are small (0.5 mm) in diameter, grayish, translucent, and slightly dry after 24 h of incubation at 37°C; one of few <i>Corynebacterium</i> spp. that hydrolyze esculin
<i>C. macginleyi</i>	Primarily eye infections; bacteremia, endocarditis, sepsis, prosthetic device infections, ventilator-associated pneumonia, infections of surgical sites and heart valves	Lipophilic; unlike most other coryneform bacteria, ferments mannitol
<i>C. propinquum</i>	Endocarditis, keratitis, pneumonia	Colonies are 1–2 mm in diameter, white, and dry with entire edges after 24 h of incubation; biochemical reactions are similar to those of <i>C. pseudodiphtheriticum</i> ; both are nitrate positive; however, <i>C. propinquum</i> is urease variable and <i>C. pseudodiphtheriticum</i> is urease positive.
<i>C. pseudodiphtheriticum</i>	Normally present in the oropharynx; causes pneumonia, endocarditis, skin ulcers, urinary tract infections, and wound infections	Colonies are similar to those of <i>C. propinquum</i> as described above; <i>C. pseudodiphtheriticum</i> and <i>C. propinquum</i> have >99% identity to each other by 16S rRNA gene sequencing, and therefore, it is difficult to differentiate them by biochemical tests unless the urease is negative for <i>C. propinquum</i> .
<i>C. pseudotuberculosis</i>	Caseous lymphadenitis in sheep and goats; human infections result from handling or consuming meat of infected animals	Colonies are 1 mm in diameter, yellowish white, opaque, and convex after 24 h of incubation; <i>C. pseudotuberculosis</i> is closely related to <i>C. ulcerans</i> ; positive urea test, reverse CAMP reaction; may possess the diphtheria <i>tox</i> gene

Table 5-1 (Continued)

Species	Clinical source and types of infections	Characteristics
<i>C. resistens</i>	Bacteremia	Colonies are grayish white and glistening, with entire edges; lipophilic organism; pyrazinamidase negative; grows slowly under anaerobic conditions
<i>C. riegelii</i>	Blood and cord blood; urinary tract infections and urosepsis	Colonies are 1.5 mm in diameter, white, glistening, and convex, although some strains may appear creamy and sticky after 48 h of incubation; urea positive; like <i>C. urealyticum</i> , it hydrolyzes urea with 5 min of incubation at room temperature; unlike other corynebacteria, it ferments lactose slowly, but not glucose.
<i>C. simulans</i>	Blood, bile; foot abscesses, lymph node infections, skin boils	Colonies are 1–2 mm in diameter, grayish white, glistening, and creamy; it is the only <i>Corynebacterium</i> sp. that reduces nitrate and nitrite.
<i>C. striatum</i>	Sterile body fluids, tissue, prosthetic devices	Colonies are 1.0–1.5 mm in diameter, shiny, creamy, and moist with entire edges after 24 h of incubation; fermentative; CAMP reaction is weak.
<i>C. ulcerans</i>	Toxigenic strains associated with respiratory diphtheria; cutaneous infections may be linked to pet infections like <i>C. pseudotuberculosis</i>	Colonies are 1–2 mm in diameter, grayish white, and dry with some hemolysis; differentiated from <i>C. diphtheriae</i> by a positive urease reaction and a reverse CAMP reaction and from <i>C. pseudotuberculosis</i> biochemically
<i>C. urealyticum</i>	Urinary tract infections, especially urine with an alkaline pH	Colonies are small, pinpoint, and whitish gray, similar to other lipophilic corynebacteria; strict aerobe; strong urease reaction and a reverse CAMP reaction
Other coryneform bacteria		
<i>Arcanobacterium haemolyticum</i>	Pharyngitis in teens and young adults, bacteremia, endocarditis, wound and tissue infections	Colonies are small (<0.5 mm) in diameter, white, and beta-hemolytic after 48 h of incubation in CO ₂ ; belongs to the family <i>Actinomycetaceae</i> along with <i>Trueperella bernardiae</i> and <i>Trueperella pyogenes</i> ; a positive reverse CAMP test confirms the identification of this catalase-negative, nonmotile, fermentative coryneform organism.
<i>Arthrobacter</i> and <i>Arthrobacter</i> -like genera	Bacteremia, endocarditis, foreign body infections, urinary tract infections	Colonies are 2 mm in diameter, whitish-gray or yellow, and creamy; can be sticky after 24 h incubation; may be motile; may require assimilation media to oxidize carbohydrates since they do not react in routine testing, e.g., API Coryne panel; definitive identification to the species level may require molecular testing.
<i>Brevibacterium</i> spp.	Normal microbiota of human skin; also found in food, the environment, and animals; bacteremia, endocarditis, foreign body-related infection, peritonitis, urinary tract infection	Colonies are ≥2 mm in diameter, white to yellow, convex, and creamy after 24 h of incubation; microscopically they appear as short bacilli, which may appear as coccoid when Gram stained from ≥3-day-old cultures; catalase positive, oxidative, and nonmotile and grow in 6.5% NaCl
<i>Cellulomonas</i> spp.	Bacteremia, cholecystitis, endocarditis, pilonidal cyst	Colonies are 0.5 to 1.5 mm in diameter, whitish, convex, and creamy after 24 h of incubation; however, they appear yellowish after 7 days; microscopically they appear as small, thin, Gram-positive bacilli.
<i>Cellulosimicrobium</i> spp.	Bacteremia, septic arthritis, foreign body-related infections	Colonies are 1 to 5 mm in diameter and yellowish and may pit the agar after 24 h incubation; molecular tests are required for definitive identification.
<i>Dermabacter hominis</i>	Normal microbiota of the skin; bacteremia; ocular, skin, and wound infections; abscesses, osteomyelitis, and peritonitis	Colonies are 1 to 1.5 mm in diameter, whitish, convex, and creamy or sticky after 48 h of incubation; microscopically they appear coccobacillary or coccoid on Gram staining; catalase positive, oxidase negative, nonmotile, and fermentative; the only catalase-positive coryneform that is able to decarboxylate lysine and ornithine

(continued)

Table 5-1 (Continued)

Species	Clinical source and types of infections	Characteristics
<i>Gardnerella vaginalis</i>	Part of anorectal microbiota of humans; may be recovered from healthy women with vaginal pH between 6 and 7; most commonly causes bacterial vaginosis; also associated with bacteremia, endometritis, postpartum sepsis, urinary incontinence, and wound infections	No phylogenetic relationship to the corynebacteria; routine cultures alone not recommended; if culture is requested, inoculate vaginalis agar (V agar) or bilayer Tween agar with human blood (HBT agar); colonies are tiny, usually beta-hemolytic after 48 h of incubation at 37°C in CO ₂ ; microscopically, Gram-variable bacilli or coccobacilli are observed; smear of vaginal discharge showing “clue cells” is suggestive of bacterial vaginosis; catalase and oxidase negative; sodium hippurate hydrolysis positive; acid production from glucose, maltose, and sucrose (variable)
<i>Microbacterium</i> spp.	Bacteremia, foreign body and wound infections	Colonies are opaque and glistening, often yellow to orange, but whitish yellow to red-orange when grown on yeast extract or milk agar after 48 to 72 h of incubation at 35°C; microscopically they appear as slender, irregular Gram-positive bacilli in singles, pairs, and V formations.
<i>Rothia dentocariosa</i>	Normal microbiota of oropharyngeal cavity; associated with dental caries and periodontal disease, endocarditis, bacteremia, respiratory tract and urogenital tract infections	Colonies are 1–2 mm in diameter, whitish, raised, and smooth and may have a spoke-wheel form when grown on blood agar after 48 h of incubation in CO ₂ ; some strains may have a grayish-black pigment; microscopically it appears as pleomorphic, Gram-positive, coccoid to rod-shaped organisms that can form branches.
<i>Trueperella bernardiae</i>	Abscess, bacteremia, necrotizing fasciitis	Colonies are small (<0.5 mm) in diameter, white, and beta-hemolytic and may appear creamy or sticky after 48 h of incubation in CO ₂ ; Gram-positive bacilli without branching compared to <i>Trueperella pyogenes</i> ; produces acid faster from maltose than from glucose; ferments glycogen
<i>Trueperella pyogenes</i>	Abscesses and wound and tissue infections	Colonies are 1 mm in diameter and beta-hemolytic after 48 h of incubation in CO ₂ ; may appear as branching Gram-positive bacilli; belongs to the family <i>Actinomycetaceae</i> along with <i>Arcanobacterium haemolyticum</i> and <i>Trueperella bernardiae</i> and can be distinguished from them by its ability to ferment xylose.
<i>Turicella otitidis</i>	Ear infections, auricular abscess, mastoiditis, bacteremia	Colonies are 1 to 1.5 mm in diameter, whitish, creamy, and convex with entire edges after 48 h incubation; appear as long Gram-positive bacilli in Gram stains

^aRefer to Table 5-2 for biochemical reactions.

Table 5-2 Identification of most frequently reported coryneform bacteria causing infections in humans^a

Species	Catalase	Nitrate	Urease	Oxidation or fermentation	Glucose	Maltose	Sucrose	Mannitol	Xylose
<i>Corynebacterium</i> species									
<i>C. amycolatum</i>	+	V	V	F	+	V	V	0	0
<i>C. aurimucosum</i>	+	0	0	F	+	+	+	0	0
<i>C. coyleae</i>	+	0	0	F	(+)	0	0	0	0
<i>C. diphtheriae</i>	+	+	0	F	+	+	0	0	0
<i>C. glucuronolyticum</i>	+	V	V	F	+	V	+	0	V
<i>C. jeikeium</i>	+	0	0	OX	+	V	0	0	0
<i>C. kroppenstedtii</i>	+	0	0	F	+	V	+	0	0
<i>C. macginleyi</i>	+	+	0	F	+	0	+	V	0
<i>C. propinquum</i>	+	+	V	OX	0	0	0	0	0
<i>C. pseudodiphtheriticum</i>	+	+	+	OX	0	0	0	0	0
<i>C. pseudotuberculosis</i>	+	V	+	F	+	+	V	0	0
<i>C. riegelii</i>	+	0	+	F	0	(+)	0	0	0
<i>C. resistens</i>	+	0	0	F	+	0	0	0	0
<i>C. simulans</i>	+	+	0	F	+	0	+	0	0
<i>C. striatum</i>	+	+	0	F	+	0	V	0	0
<i>C. tuberculostearicum</i>	+	V	0	F	+	V	V	0	0
<i>C. ulcerans</i>	+	0	+	F	+	+	0	0	0
<i>C. urealyticum</i>	+	0	+	OX	0	0	0	0	0
Other coryneform bacteria									
<i>Arcanobacterium haemolyticum</i>	0	0	0	F	+	+	V	0	0
<i>Arthrobacter, Arthrobacter-like spp.</i>	+	V	V	OX	V	V	V	0	0
<i>Brevibacterium spp.</i>	+	V	0	OX	V	V	V	0	0
<i>Cellulomonas spp.</i>	+	+	0	F	+	+	+	V	+
<i>Cellulosimicrobium spp.</i>	+	V	V	F	+	+	+	0	+
<i>Dermabacter hominis</i>	+	0	0	F	+	+	+	0	V
<i>Gardnerella vaginalis</i>	0	0	0	F	+	+	V	0	0
<i>Microbacterium spp.</i>	V	V	V	F/OX	+	+	V	V	V
<i>Rothia dentocariosa</i>	V	+	0	F	+	+	+	0	0
<i>Trueperella bernardiae</i>	0	0	0	F	+	+	0	0	0
<i>Trueperella pyogenes</i>	0	0	0	F	+	V	V	V	+
<i>Turicella otitidis</i>	+	0	0	OX	0	0	0	0	0

^a+, positive reaction (≥90% positive); V, variable reaction (11 to 89% positive); 0, negative reaction (≤10% positive); F, fermentation; OX, oxidation; parentheses indicate a delayed or weak reaction.

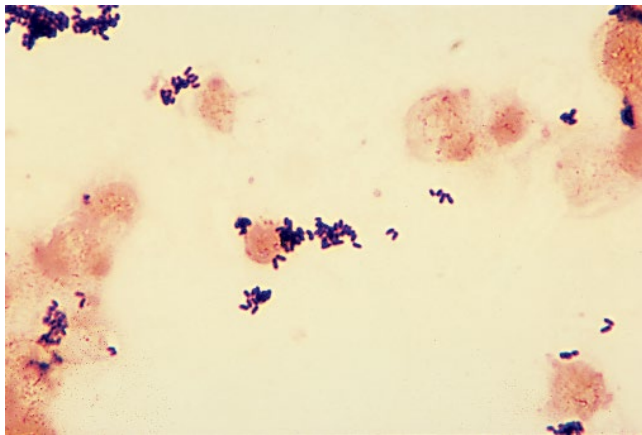


Figure 5-1 Gram stain of *Corynebacterium* spp. The small, Gram-positive bacilli, 1 by 3 μm in size, appear in palisade, V, and L forms. This arrangement is the result of a type of cell division referred to as “snapping,” which causes the cells to arrange themselves in both parallel and perpendicular formations.

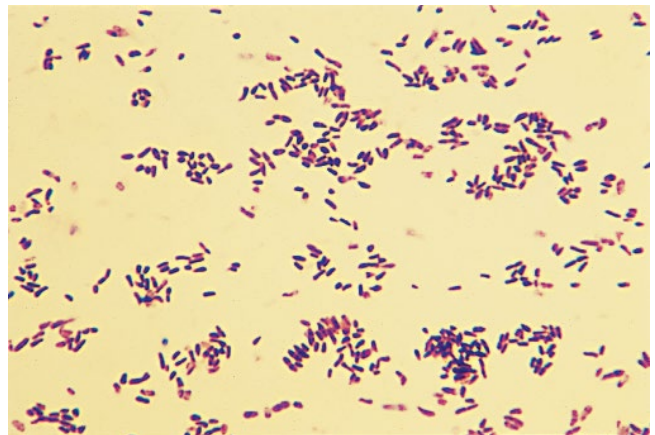


Figure 5-2 Gram stain of *Corynebacterium diphtheriae*. *C. diphtheriae* appears similar to other *Corynebacterium* spp. on Gram staining. The arrangement of these small, Gram-positive bacilli, 1 by 3 μm in size, resembles that shown in Fig. 5-1. Another recommended stain is methylene blue. However, although metachromatic granules are in cells of *C. diphtheriae* when grown on Loeffler’s medium and stained with methylene blue, these granules can occur in the cells of other corynebacteria.

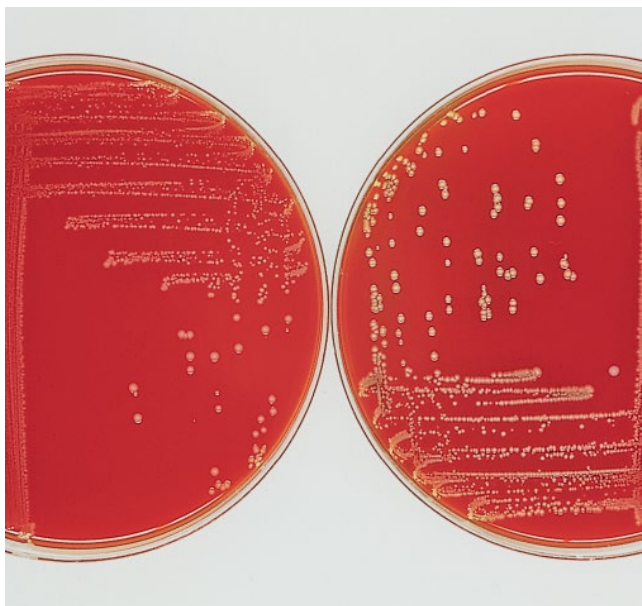


Figure 5-3 *Corynebacterium diphtheriae* on blood agar and colistin-nalidixic acid blood agar (CNA). *C. diphtheriae* grows well as nonhemolytic, whitish, opaque colonies after overnight incubation on blood agar under 5 to 10% CO_2 . Although blood agar is a primary isolation medium, CNA is recommended as a selective medium for the isolation of *C. diphtheriae* and other corynebacteria if tellurite medium is not available. Here, *C. diphtheriae* cells are shown on blood agar (left) and CNA (right). If CNA is used as the selective medium for the isolation of *C. diphtheriae*, several colonies should be picked for stains and biochemical tests, because other organisms can also grow on this medium.



Figure 5-4 *Corynebacterium diphtheriae* on blood agar with a 200- μg fosfomycin disk. Corynebacteria, including *C. diphtheriae*, are highly resistant to fosfomycin (>50 μg); therefore, a blood agar-based medium containing up to 100 μg of fosfomycin/ml can serve as a selective medium for the isolation of most corynebacteria. Alternatively, a fosfomycin disk can be placed on a blood agar plate. In this example, *C. diphtheriae* growth is not inhibited by 200 μg of fosfomycin.

Figure 5-5 *Corynebacterium diphtheriae* on tellurite agar. Primary plating media for *C. diphtheriae* should include a blood agar plate and a selective medium, preferably containing potassium tellurite. On the selective tellurite medium, *C. diphtheriae* colonies have a gun-metal, gray-black appearance, as shown, while other corynebacteria grow but most do not reduce tellurite.

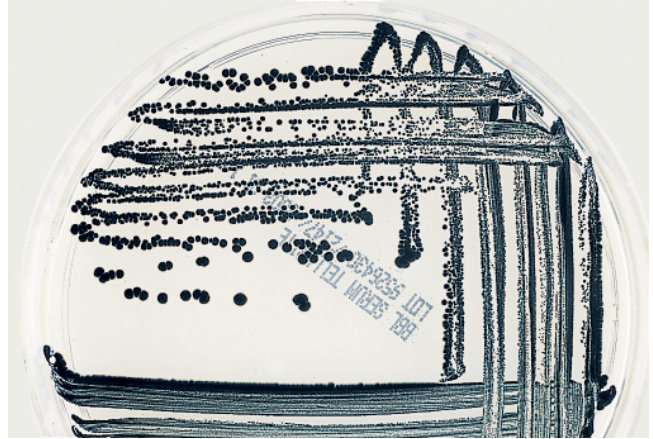
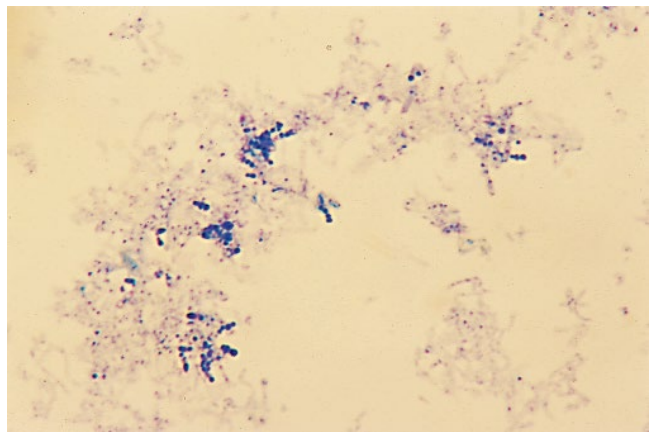


Figure 5-6 *Corynebacterium diphtheriae* on Loeffler's serum agar slant. Loeffler's serum agar slant is no longer recommended as a primary plating medium for the isolation of *C. diphtheriae* because of the overgrowth of other bacteria. On Loeffler's medium, there is no characteristic appearance to distinguish the corynebacteria from other aerobic, Gram-positive bacilli. However, it is important to inoculate suspected colonies of *C. diphtheriae* onto this medium to check for metachromatic granules, which are detected by staining with methylene blue.



Figure 5-7 Methylene blue stain showing metachromic granules. *C. diphtheriae* and other *Corynebacterium* spp. produce metachromatic granules (polar bodies) when grown on Loeffler's serum agar. These granules, also known as volutin granules, are an accumulation of inorganic polyphosphates. Methylene blue imparts a deeper blue or red hue to the metachromatic granules of *C. diphtheriae*. These are demonstrated microscopically here.



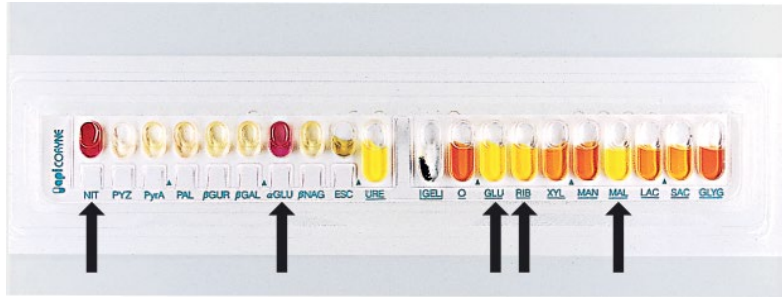


Figure 5-8 *Corynebacterium diphtheriae* identified by the API Coryne system. The API Coryne (bioMérieux, Inc., Durham, NC) is a commercial test system that is designed for the identification of *Corynebacterium* spp. and related bacteria. It consists of 20 dehydrated substrates for the demonstration of enzymatic activity or the fermentation of carbohydrates. Following inoculation, the strip is incubated at 35 to 37°C for 24 h. Positive reactions, indicated by the arrows, are indicated by a color change. In this example, from left to right, positive reactions occur in nitrate (NIT), α -glucosidase (α GLU), glucose (GLU), ribose (RIB), and maltose (MAL). A catalase test was positive for this isolate. This combination of test reactions confirmed the identification of *C. diphtheriae*.



Figure 5-9 *Corynebacterium jeikeium* on blood agar with Tween 80. *C. jeikeium* is a lipophilic *Corynebacterium* species, and its growth is enhanced by the addition of 0.1 to 1.0% Tween 80. In this case, Tween 80 was added to the blood agar plate. This image demonstrates the enhanced growth on the area of the plate where the Tween 80 was added.

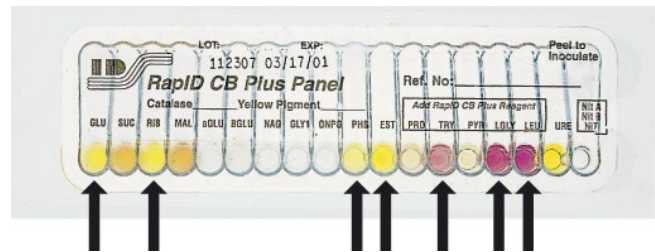


Figure 5-10 *Corynebacterium jeikeium* identified by the RapID CB Plus system. The RapID CB Plus system (Thermo Scientific, Remel Products, Lenexa, KS) is a micromethod employing an 18-well system with conventional and chromogenic substrates for the identification of medically important corynebacteria and related organisms. Inoculated panels are incubated for 4 to 6 h at 35 to 37°C in an atmosphere without CO₂. Reagents are added, and the results are interpreted as specified by the manufacturer. For the first 11 wells, a yellow or yellow-orange color is interpreted as positive; for the remaining wells, purple, red, or pink colors indicate a positive reaction. In this example, glucose (GLU), ribose (RIB), *p*-nitrophenyl phosphate (PHS), fatty acid ester (EST), tryptophan- β -naphthylamide (TRY), leucylglycine- β -naphthylamide (LGLY), and leucine- β -naphthylamide (LEU) are positive, as indicated by the arrows. These reactions are consistent with *C. jeikeium*.

Figure 5-11 *Corynebacterium pseudodiphtheriticum* identified by the API Coryne system. Reactions are interpreted as described in the legend to Fig. 5-8. In this example, nitrate (NIT), pyrazinamidase (PYZ), and urease (URE) are positive, as indicated by the arrows. The catalase test was also positive for this organism. These reactions confirm the identification of *C. pseudodiphtheriticum*.

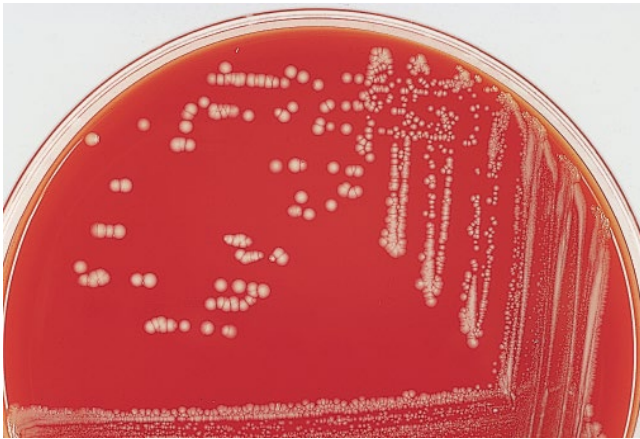


Figure 5-12 *Corynebacterium pseudodiphtheriticum* on blood agar. Colonies of *C. pseudodiphtheriticum* are white and slightly dry with entire edges and measure approximately 2 mm in diameter after 48 h of incubation.

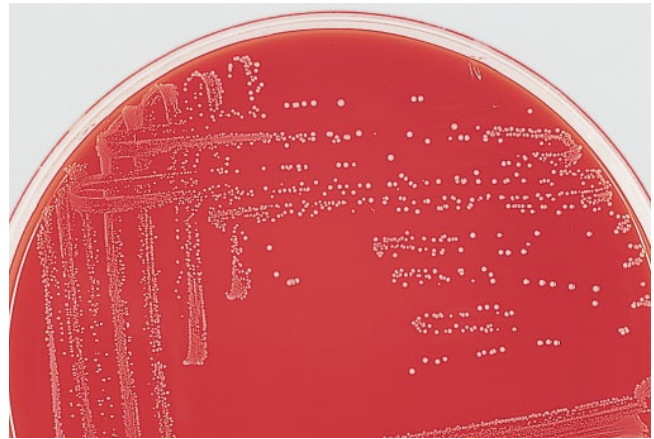


Figure 5-13 *Corynebacterium urealyticum* on blood agar. Colonies of *C. urealyticum* are pinpoint to small (approximately 0.5 to 1 mm in diameter), convex, smooth, and whitish-grayish on blood agar. Like *C. jeikeium*, *C. urealyticum* is a lipophilic species; therefore, growth is enhanced when it is grown in the presence of Tween 80.

Figure 5-14 *Corynebacterium urealyticum* on a urea agar slant. *C. urealyticum* hydrolyzes urea very quickly when inoculated onto a urea agar slant. This results in a pink color throughout the medium.



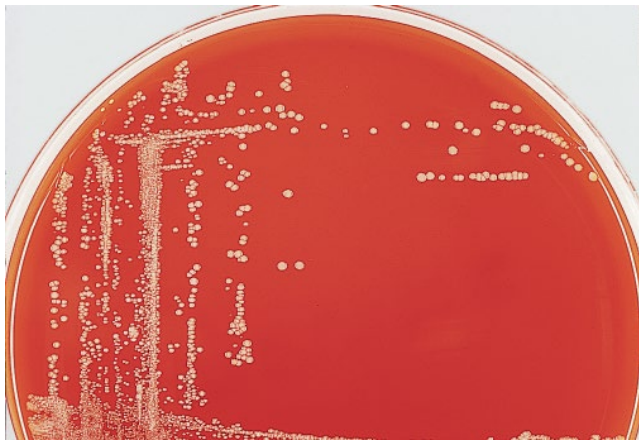


Figure 5-15 *Corynebacterium xerosis* on blood agar. Colonies of *C. xerosis* on blood agar are small to medium in size (1 to 3 mm in diameter), dry, pale yellow, and granular.

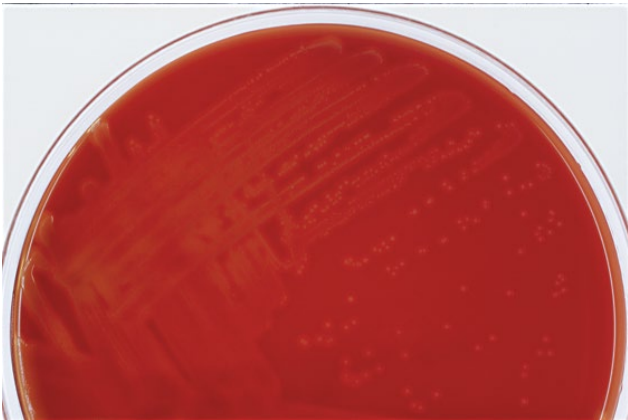


Figure 5-16 *Arcanobacterium haemolyticum* on blood agar. Colonies of *A. haemolyticum* are small (<0.5 to 1 mm in diameter) and beta-hemolytic on blood agar when incubated for 48 h at 35 to 37°C under CO₂. The colonies can be either smooth or rough. In general, the smooth form, shown here, is isolated from wound specimens and the rough form is isolated from respiratory specimens. Colonies of *Trueperella pyogenes* have a similar appearance.

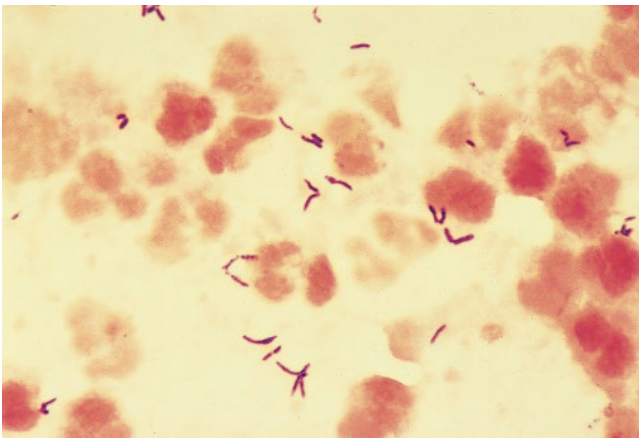


Figure 5-17 Gram stain of *Trueperella pyogenes*. This Gram stain of *T. pyogenes* was prepared from a peritonsillar abscess. These Gram-positive bacilli are longer than corynebacteria, measuring up to 6 µm in length. Both V formation and branching can be seen; both are characteristics of this organism.

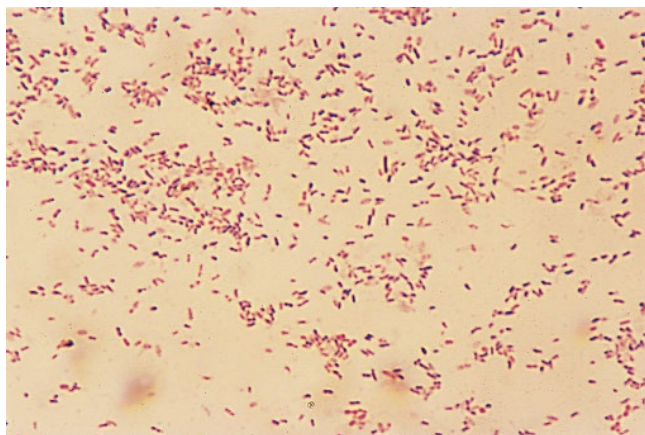


Figure 5-18 Gram stain of *Gardnerella vaginalis*. *G. vaginalis* appears as thin, Gram-variable bacilli and coccobacilli, as shown here. Because of the variable Gram reaction, this organism was previously included in the genera *Corynebacterium* and *Haemophilus*.

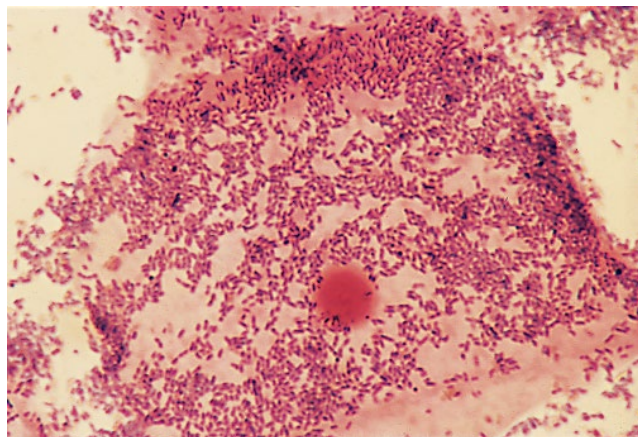


Figure 5-19 Gram stain of a clue cell. A clue cell is an epithelial cell covered with mixed bacteria collected from a vaginal discharge of a patient with bacterial vaginosis. The typical smear, as seen in the figure, shows the clue cell (epithelial cell) covered with small, Gram-variable bacilli and coccobacilli.

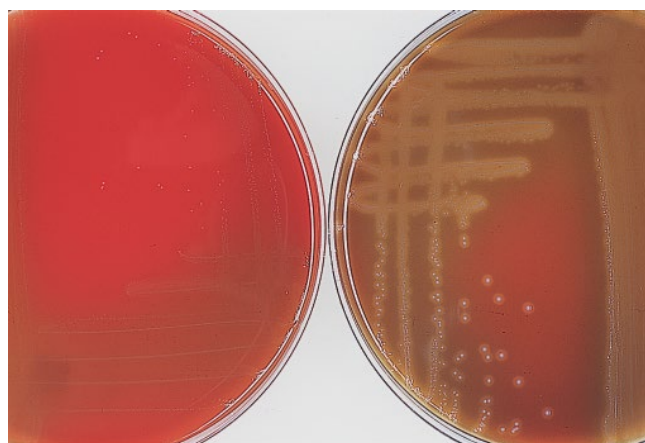


Figure 5-20 Colonies of *Gardnerella vaginalis* on blood agar and vaginalis agar (V agar). Shown here are colonies of *G. vaginalis* growing on 5% blood agar (left) and V agar (right). V agar is a nonselective enriched medium containing human blood that supports the isolation and beta-hemolytic reaction of *G. vaginalis*. Colonies growing on 5% sheep blood agar are barely visible after incubation for 48 h at 37°C in an atmosphere of 5 to 7% CO₂, while colonies grown on V agar with 5% human blood are opaque, measuring 1 mm in diameter, and surrounded by zones of beta-hemolysis.



Figure 5-21 Reverse CAMP (inhibition) test for *Arcanobacterium haemolyticum*. The CAMP inhibition test determines whether the test organism inhibits the effect of *Staphylococcus aureus* β-hemolysin on sheep red blood cells. In this image, a strain of *S. aureus* was inoculated onto a sheep blood agar plate, and two streaks of the test organism, *A. haemolyticum*, were inoculated vertically, but not touching the *S. aureus* streak. Following overnight incubation at 37°C, a β-hemolysin inhibition zone in the form of a triangle is observed. The other coryneform Gram-positive bacilli that produce a similar reaction are *C. pseudotuberculosis* and *C. ulcerans*. This reaction differs from a positive CAMP test, which is characterized by an arrowhead-shaped zone of complete hemolysis in the area where the staphylococcal β-hemolysin and the CAMP factor have diffused (not shown here).

6

Listeria and *Erysipelothrix*

The genus *Listeria* includes several species; however, only *Listeria monocytogenes* and *Listeria ivanovii* are pathogenic to humans and animals. *Listeria innocua*, the species most frequently isolated from foods, is not a human pathogen. These organisms can be isolated from soil, water, and vegetation. The term *Listeria sensu stricto* was proposed to include *L. monocytogenes*, *L. ivanovii*, *Listeria marthii*, *L. innocua*, *Listeria welshimeri*, and *Listeria seeligeri*. Other species, such as *Listeria grayi*, are classified as *Listeria sensu lato*. The latter group is distinguished by its ability to reduce nitrate to nitrite and by its lack of motility (except for *L. grayi*).

L. monocytogenes causes infections mainly during the summer months in pregnant women, newborns, patients with compromised cell-mediated immunity (such as individuals with AIDS, lymphomas, and transplants), and elderly persons. High mortality rates can occur in pregnant and immunocompromised patients. During gestation, *L. monocytogenes* can lead to amnionitis and infection of the fetus, which can result in termination of the pregnancy. In newborns, early- and late-onset of disseminated clinical symptoms can occur as a result of intrauterine infection or contamination of environmental sources such as milk products. Neonates suffering from fetomaternal listeriosis may develop granulomatosis infantiseptica with formation of pyogenic granulomas over the whole body. Both epidemics and sporadic cases have been described. Food, particularly dairy products and meat, is the most common vehicle of transmission. In addition to septicemia, infections of the central nervous system, including

meningitis and encephalitis, are the most frequent clinical presentations. *L. ivanovii* is mainly a pathogen of ruminants, but human systemic infections can occur, particularly in patients with HIV-1.

Blood, amniotic fluid, and cerebrospinal fluid (CSF) are frequently submitted for detection of *L. monocytogenes*. Cultures of specimens from nonsterile sites, such as the vagina or stool, are often not diagnostically useful, since approximately 1 to 5% of healthy individuals are colonized. However, for studies of carriage, stool specimens rather than rectal swabs are preferred for isolating this organism from the gastrointestinal tract. Although *L. monocytogenes* grows well on blood and chocolate agars, cold enrichment, performed by storing the specimen in the refrigerator for several days, decreases contamination with rapidly growing bacteria and enhances recovery when specimens are plated from nonsterile sites. Selective media for culturing *Listeria* spp. include lithium chloride-phenylethanol-moxalactam and PALCAM agars. PALCAM is a highly selective medium due to the inclusion of polymyxin B, acriflavine hydrochloride, lithium chloride, ceftazidime and esculin-mannitol. Chromogenic media for the selective isolation of *Listeria* spp. are commercially available.

L. monocytogenes is an aerobic, non-spore-forming, short (0.4 to 0.5 μm by 0.5 to 2 μm), Gram-positive bacillus, or coccobacillus, with rounded ends, occurring singly or in short chains. In CSF, the organism may be intracellular or extracellular, and it can be confused with *Enterococcus* spp. or *Streptococcus pneumoniae* if the cells are coccoid and arranged in pairs. *L.*

monocytogenes may also have a pleomorphic palisade structure resembling that of *Corynebacterium*. If the Gram stain is overdecolorized, this organism can also be confused with *Haemophilus*.

Identification of *L. monocytogenes* from clinical specimens is based on Gram stain morphology, a narrow zone of beta-hemolysis on blood agar, tumbling motility, esculin hydrolysis, positive catalase reaction, positive hippurate reaction, negative reaction for H₂S, acid production from D-glucose, and positive Voges-Proskauer and methyl red reactions. *L. ivanovii* produces large zones of beta-hemolysis, while *L. innocua* is nonhemolytic. A pathogenicity island clusters the virulence genes coding for internalin A and B and listeriolysin. Molecular techniques, including whole-genome sequencing and matrix-assisted laser desorption ionization-time of flight mass spectrometry (MALDI-TOF MS), are available for the identification and epidemiological characterization of *Listeria* spp. Commercially available meningitis and encephalitis molecular tests can detect *L. monocytogenes* in CSF in 1 hour.

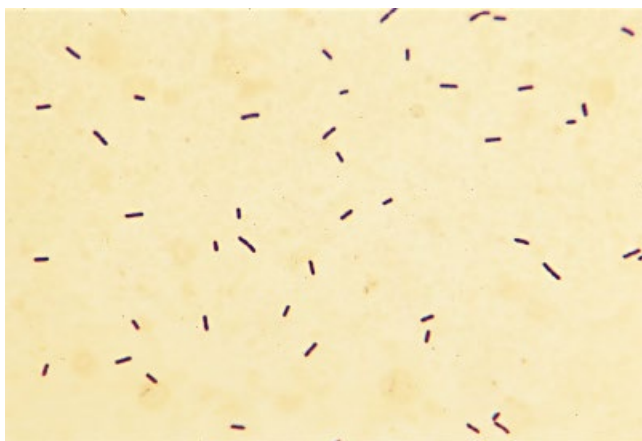
Four species, *Erysipelothrix rhusiopathiae*, *Erysipelothrix tonsillarum*, *Erysipelothrix inopinata*, and *Erysipelothrix larvae*, are included in the genus *Erysipelothrix*. Only *E. rhusiopathiae* is known to be a human pathogen. *E. rhusiopathiae* is carried by a variety of animals and occasionally causes a human cutaneous infection called erysipeloid, which is localized on the hands. This lesion is acquired as a result of skin abrasion, injury, or bites from infected animals, particularly domestic swine and fish. Therefore, veterinarians,

butchers, and fish handlers are frequently affected. Generalized cutaneous infections are rare. The infection can disseminate in immunocompromised patients, resulting in bacteremia and endocarditis.

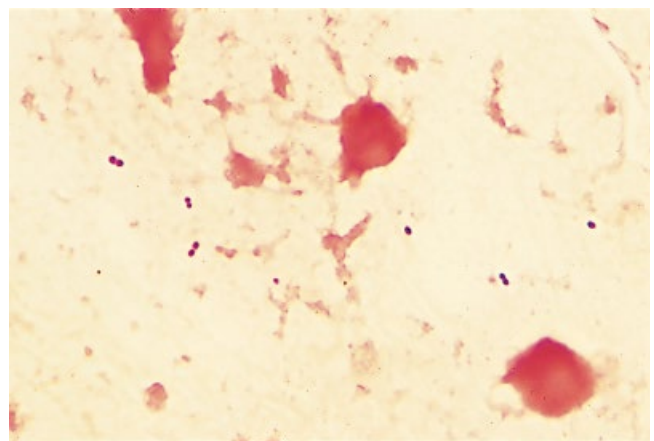
E. rhusiopathiae is a Gram-positive, nonsporulating, thin, short (0.2 to 0.4 μm by 0.8 to 2.5 μm) bacillus with rounded ends; it is usually found singly or in short chains but has a tendency to form slender, long filaments up to 60 μm in length.

Clinical specimens, such as tissues and biopsy samples, can be plated on blood or chocolate blood agar. Specimens plated on tryptic soy, Schaedler, or thioglycolate broth should be incubated at 35 or 37°C, aerobically, or in 5% CO₂, for 7 days. Blood from patients with sepsis can be inoculated into commercial blood culture systems or into nutrient broth with 1% glucose, incubated at 35°C under 5% CO₂, and subcultured daily.

Erysipelothrix spp. are catalase and oxidase negative, do not hydrolyze esculin, and are methyl red and Voges-Proskauer negative. These organisms do not produce indole or hydrolyze urea, but they produce H₂S in triple sugar iron agar. This last characteristic helps to differentiate members of this genus from *Lactobacillus*, *Listeria*, *Brochothrix*, and *Kurthia*. In addition, *Erysipelothrix* does not grow at 4°C, while *Listeria* can grow at low temperatures. Sucrose can be used to differentiate two species of *Erysipelothrix*: *E. rhusiopathiae* is sucrose negative, whereas *E. tonsillarum* is positive. Typing of *Erysipelothrix* can be performed using molecular techniques.



A



B

Figure 6-1 Gram stain of *Listeria monocytogenes*. (A) A Gram stain shows the typical morphology of *L. monocytogenes*, consisting of single or short chains of small, Gram-positive bacilli. (B) Older cultures often appear Gram variable with a coccoid morphology that can also occur in clinical specimens such as CSF, as shown here. In this particular case, it is very important to differentiate *L. monocytogenes* from *S. pneumoniae*.

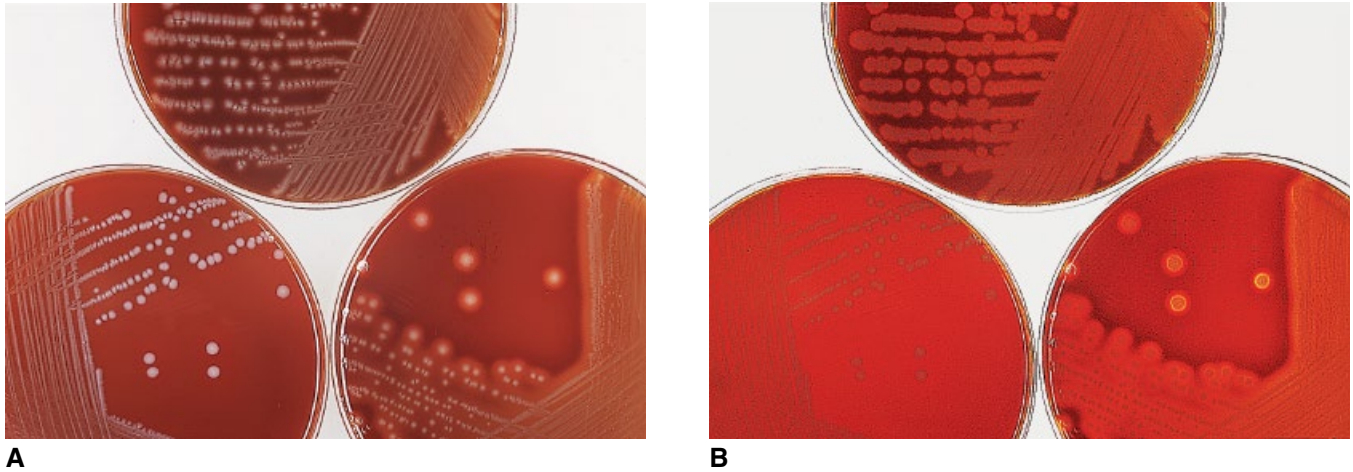


Figure 6-2 *Listeria* spp. on blood agar. (A) Front light; (B) back light. The colonies of *L. monocytogenes* (top) are small, translucent, or gray with a narrow zone of beta-hemolysis and can easily be confused with group B streptococci. Hemolysis is important for differentiating between *L. monocytogenes* and the other two species of *Listeria* that are beta-hemolytic: *L. monocytogenes* and *L. seeligeri* produce zones of hemolysis that frequently do not extend beyond the edge of the colony, while *L. ivanovii* (bottom right) produces large zones of hemolysis. Thus, in the case of *L. monocytogenes* and *L. seeligeri*, removal of the colony may be required to observe the hemolysis. *L. innocua* (bottom left), on the other hand, is nonhemolytic.

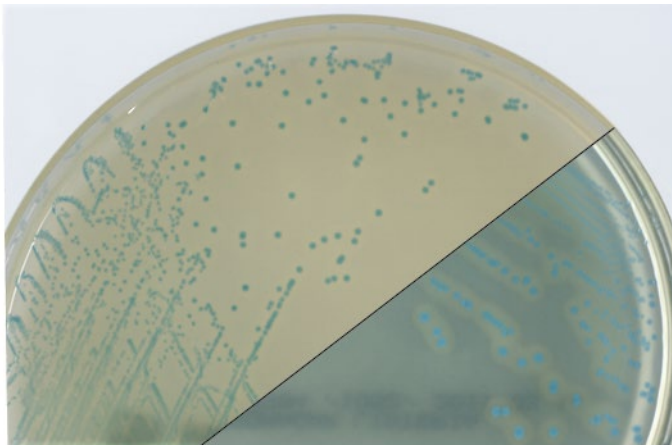


Figure 6-3 *Listeria monocytogenes* on chromogenic media. Phosphatidylinositol-specific phospholipase C is an enzyme produced only by *L. monocytogenes* and *L. ivanovii*. Chromogenic substrates are incorporated into the plating medium to allow the rapid identification of colonies by a characteristic color. On BD CHROMagar *Listeria* (BD Diagnostic Systems, Franklin Lakes, NJ), *L. monocytogenes* and *L. ivanovii* produce blue-green colonies surrounded by an opaque, white halo; however, the colonies of *L. ivanovii* are smaller (top left, front light; bottom right, back light).



Figure 6-4 Motility of *Listeria monocytogenes* on semisolid medium. In a tube of semisolid medium incubated overnight at room temperature, *L. monocytogenes* develops a typical umbrella-shaped pattern as a result of its motility (shown here), whereas when it is incubated at 37°C, this pattern does not occur. The end-over-end tumbling motility can be observed under a microscope after incubation for 1 to 2 h in nutrient broth at room temperature (not shown).

Figure 6-5 The CAMP test. The CAMP test is used to differentiate between species of *Listeria*. Here, *Staphylococcus aureus* and *Rhodococcus equi* were streaked in one direction on a blood agar plate and test cultures of the *Listeria* spp. were streaked at right angles to the *S. aureus* and *R. equi* streaks but without touching the streaks. *L. monocytogenes* and *L. seeligeri* hemolysis is enhanced in proximity to *S. aureus* (top plate); *L. ivanovii* hemolysis is enhanced near *R. equi*, giving the typical picture of a shovel (bottom plate). Depending on the strain, the hemolysis of *L. monocytogenes* may or may not be enhanced near *R. equi*. The CAMP factor is a diffusible extracellular protein produced by certain organisms, such as *L. monocytogenes*, *L. seeligeri*, and most group B streptococci, that acts synergistically with the staphylococcal beta-lysin. The CAMP test is not reliable, and a commercially available beta-hemolysis disk method (Remel Products, Lenexa, KS) is recommended.

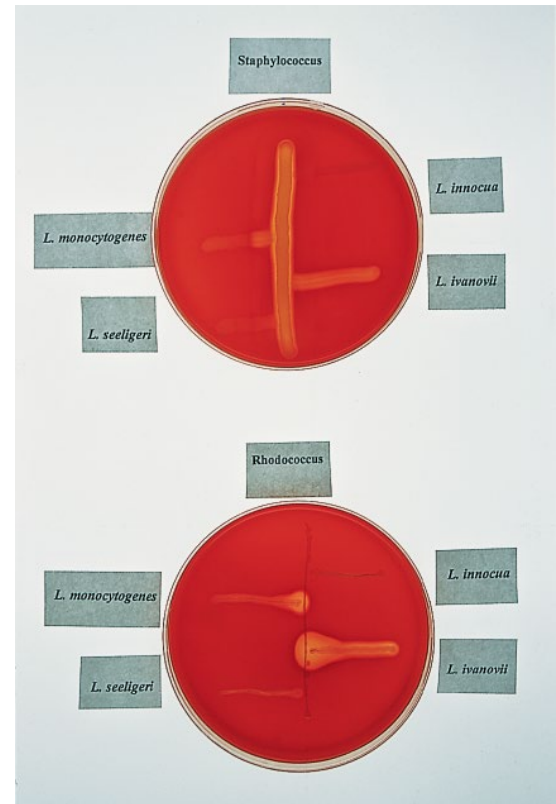
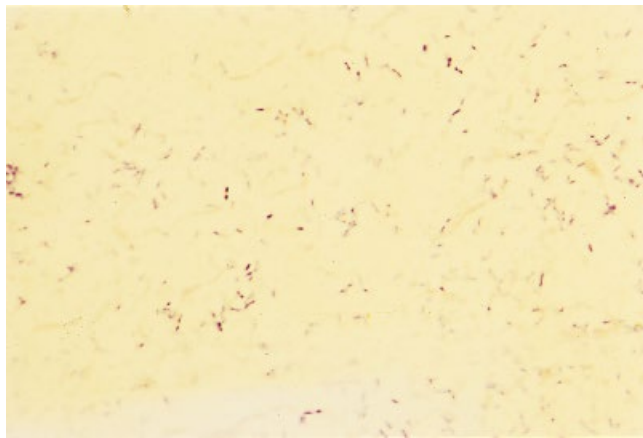
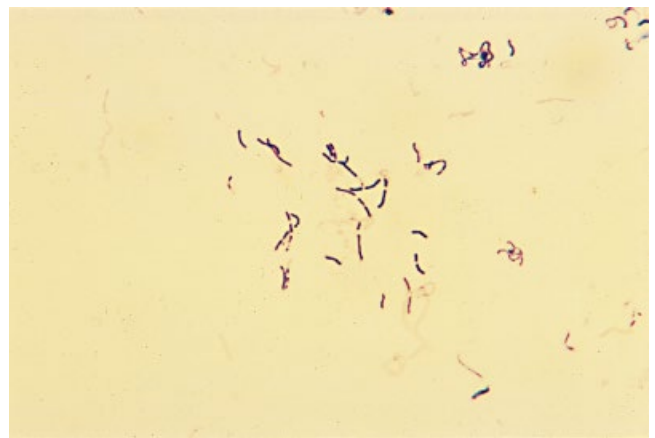


Figure 6-6 Micro-ID Listeria system. The Micro-ID Listeria assay (Remel Micro-ID Listeria Identification System; Thermo Fisher Scientific, Inc., Waltham, MA) includes 15 biochemical tests used to identify *Listeria* to the species level. An additional test for hemolytic activity is required to differentiate between *L. monocytogenes* and *L. innocua*. As shown here, *L. monocytogenes* and *L. innocua* are D-xylose (XYL) and mannitol (MANN) negative and L-rhamnose (RHAM) positive, while *L. seeligeri* is D-xylose positive.

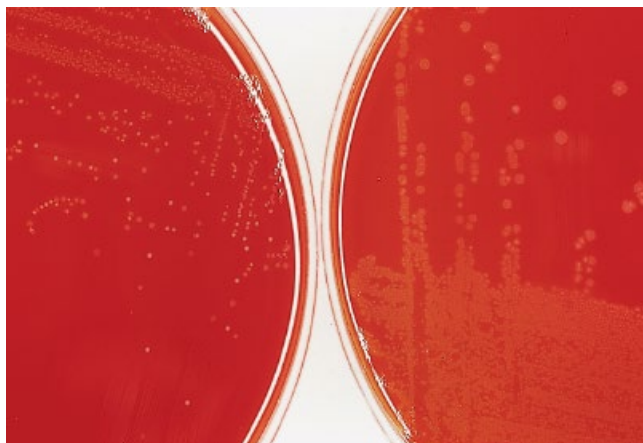


A

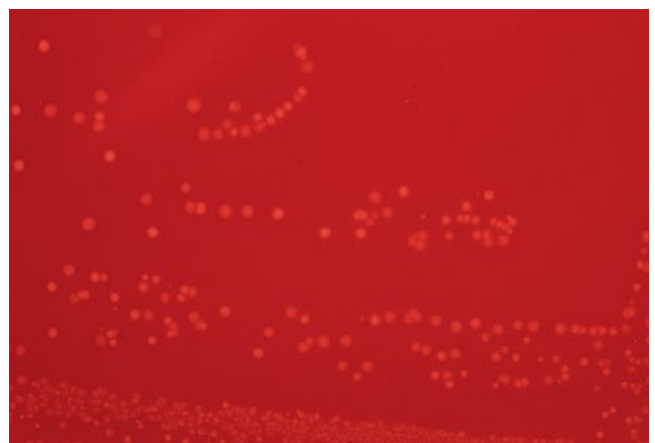


B

Figure 6-7 Gram stain of *Erysipelothrix rhusiopathiae*. *E. rhusiopathiae* is Gram positive but can be easily decolorized, giving a beaded appearance. Bacteria stained from smooth colonies appear as bacilli or coccobacilli (A), while cells from rough colonies are long and filamentous (B). Rough colonies preferentially grow at 37°C and smooth colonies at 30°C.



A



B

Figure 6-8 *Erysipelothrix rhusiopathiae* on blood agar. Colonies of *E. rhusiopathiae* at 24 h are small and pinpoint (A, left). By 72 h, two types can be recognized: smooth, transparent, glistening, circular, convex colonies with entire edges, measuring approximately 1 mm in diameter (A, right), and larger, rough colonies that are flat and opaque, with a matte surface and an irregular edge (B). The colonies are nonhemolytic, although a greenish discoloration can be found under them.



Figure 6-9 *Erysipelothrix rhusiopathiae* in a gelatin stab culture. A useful differential characteristic of *E. rhusiopathiae* is its “pipe cleaner” or “bottle brush” pattern of growth in gelatin stab cultures incubated at 22°C.



Figure 6-10 Production of H₂S by *Erysipelothrix*. As shown here, *Erysipelothrix* species produce H₂S on a triple sugar iron agar slant.

Bacillus



The genus *Bacillus* belongs to the family *Bacillaceae*. There are more than 300 species of *Bacillus*; however, the most frequently isolated are *Bacillus cereus*, *Bacillus licheniformis*, *Bacillus megaterium*, *Bacillus mycoides*, *Bacillus pumilus*, *Bacillus simplex*, *Bacillus subtilis*, and *Bacillus thuringiensis*. Another species, previously classified within the genus *Bacillus*, has been transferred to the genus *Geobacillus*. *Geobacillus stearothermophilus* is frequently used as an indicator organism in autoclave sterility testing. Most *Bacillus* spp. are saprophytes and are widely distributed in nature, but some are opportunists. The exceptions are *Bacillus anthracis* and *B. cereus* biovar anthracis, which are obligate pathogens of humans and animals.

Microscopically, *Bacillus* spp. are Gram-positive bacilli; however, it is not unusual for them to be Gram variable or Gram negative, especially in older cultures. They produce endospores and may be either aerobes or facultative anaerobes. Endospores are very resistant to heat, radiation, disinfectants, and desiccation and are frequent contaminants of otherwise clean environments, such as operating rooms, pharmaceutical products, and food. They can germinate when hydrated and, in the case of food, can cause spoilage or result in food poisoning.

Bacillus spp. are catalase positive and hydrolyze gelatin, casein, and starch; most species, with the exception of *B. anthracis* and *B. mycoides*, are motile. Other tests that assist in the identification of *Bacillus* spp. are those for lecithinase production (egg yolk reaction), nitrate reduction, and the ability to grow anaerobically.

Identification systems, e.g., API 20E (bioMérieux, Inc., Durham, NC), can be used to identify members of the *B. cereus* group. The pathogenicity of the *B. cereus* group is due to the production of cytolysins, endotoxins, exotoxins, and hemolysins.

B. anthracis is clinically the most important member of the genus, since it is the causative agent of anthrax in animals and humans. Anthrax is primarily a disease of herbivores and humans and is contracted by direct or indirect contact with infected animals or their carcasses. Dissemination of toxigenic strains is a major public health concern. For this reason, diagnostic laboratories should be prepared to recognize *B. anthracis* from clinical specimens and refer suspicious isolates to the appropriate laboratory, carefully following CDC guidelines (<https://www.cdc.gov/biosafety/publications/bmb15/>) and guidelines found in the LRN Sentinel Level Clinical Microbiology Laboratory Guidelines, available from the American Society for Microbiology (<https://www.asm.org/Articles/Policy/Laboratory-Response-Network-LRN-Sentinel-Level-C>). It is recommended that isolation and presumptive identification of *B. anthracis* be performed using biosafety level 2 practices.

The three major clinical presentations of anthrax are cutaneous, respiratory (inhalation), and gastrointestinal (ingestion). Cutaneous anthrax presents with a nondescript painless papule that evolves from a vesicle with central necrosis and formation of a black eschar; it accounts for 99% of naturally acquired anthrax cases worldwide. Inhalation anthrax begins with a flu-like illness, and subsequently, the patient develops wheezing,

cyanosis, shock, and meningitis. X rays of the chest show pulmonary infiltrates or mediastinal widening due to enlarged mediastinal lymph nodes and pleural effusions. Ingestion anthrax occurs in two forms: oral or oropharyngeal and gastrointestinal. In oral or oropharyngeal infection, the lesion is in the buccal cavity or on the tongue, tonsil, or posterior pharyngeal wall. The symptoms can include sore throat with cervical edema, dysphagia, and respiratory difficulties. Intestinal anthrax causes nausea, vomiting, sepsis, and bloody diarrhea with ulcerations primarily in the mucosae of the terminal ileum or cecum. The three virulence factors of *B. anthracis*—edema toxin, lethal toxin, and a capsular antigen—contribute to the high mortality rate, especially in cases of intestinal and pulmonary anthrax.

If the microscopic and colony morphologies of the organism being studied are consistent with *B. anthracis* and the isolate is nonhemolytic, catalase positive, and nonmotile, the LRN laboratory should be notified immediately and the isolate sent to rule out *B. anthracis*. Gram staining of the colonies reveals Gram-positive bacilli in chains with oval spores that do not cause significant swelling of the cells. Spores may also be observed in a wet mount, phase microscopy, or a malachite green stain. Spores are not found in clinical material unless it is exposed to CO₂. Microscopically, *B. anthracis* cells are Gram-positive bacilli measuring 1 to 1.5 μm by 3 to 5 μm. When seen in clinical specimens, the bacilli appear encapsulated and occur in short chains of two to four cells. India ink may be used to visualize the capsules by direct examination of peripheral blood, cerebrospinal fluid, or cells grown on medium supplemented with sodium bicarbonate. In addition, M'Fadyean stain (polychrome methylene blue) may be used for capsule staining of *B. anthracis*. A direct fluorescent-antibody (DFA) assay has been used to detect the galactose/*N*-acetylglucosamine cell wall-associated polysaccharide and capsule produced by vegetative cells of *B. anthracis*. The availability of monoclonal antibodies recognizing the cell wall polysaccharide and capsule antigens provides the ability to rapidly differentiate *B. anthracis* from other *Bacillus* spp.

Both blood and chocolate agars support the growth of *B. anthracis*. Growth is rapid, and colonies may be observed on blood agar within 8 h. After overnight incubation at 35 to 37°C on blood agar, colonies are 2 to 5 mm in diameter, nonhemolytic, and flat or slightly convex, with irregular or waxy borders and a ground-glass appearance. The colonies have a tenacious consistency, causing them to pull up, like a beaten egg white, when teased with an inoculating loop. Some of the tests that may be performed in reference laboratories to confirm *B. anthracis* include lysis by gamma phage, DFA assay, time-resolved fluorescence, and molecular characterization, as well as antimicrobial susceptibility testing.

B. cereus is also an important pathogen in humans, causing catheter-related bacteremia and foodborne illness often associated with consumption of Asian-style fried rice. This organism causes two forms of foodborne illness: intoxication and true infection. Intoxication is caused by a heat-stable enterotoxin, resulting in an abrupt onset of nausea and vomiting within 1 to 5 h after ingestion of the contaminated food. True infection is caused by a heat-labile enterotoxin, resulting in abdominal pain and diarrhea within 8 to 16 h after the food ingestion. *B. cereus* can also cause serious eye and wound infections following trauma.

B. cereus colonies are large (4 to 7 mm in diameter) and beta-hemolytic and vary in shape from circular to irregular with a grayish to greenish color and a ground-glass appearance. The colonies may appear very similar to those of *B. anthracis*, except that *B. cereus* is hemolytic and usually motile and grows on phenylethyl alcohol blood agar. Other reactions that differentiate *B. cereus* from *B. anthracis* and other members of the *Bacillaceae* are that it is lecithinase positive and gelatin hydrolysis positive and produces acid from glucose, maltose, and salicin.

Of recent concern are strains of *B. cereus* biovar anthracis described in early 2000 in the African countries of Cameroon and Côte d'Ivoire. These strains cause anthrax-like disease, are genetically

Table 7-1 Differentiation of *B. anthracis*, *B. cereus*, *B. cereus* biovar anthracis CA, and *B. cereus* biovar anthracis CI^a

Organism	Hemolysis on sheep blood agar	Motility	Penicillin G	Capsule
<i>B. anthracis</i>	0	0	S	+
<i>B. cereus</i>	+	+	R	0 <i>in vitro</i>
<i>B. cereus</i> biovar anthracis CA	0	+/0	R	+
<i>B. cereus</i> biovar anthracis CI	0	+/0	S	+

^aCA, Cameroon strains; CI, Côte d'Ivoire strains; 0, negative; +, positive; S, susceptible; R, resistant; +/-, variable (the majority are positive).

similar to *B. anthracis*, produce *B. anthracis* virulence factors, and are considered select agents in the United States. They differ from other *B. cereus* strains in that they are nonhemolytic and demonstrate a capsule. The characteristics of *B. anthracis*, *B. cereus*, and *B. cereus* biovar anthracis strains are presented in Table 7-1.

Isolation and presumptive identification of *B. cereus* and *B. cereus* biovar anthracis strains should also be performed using biosafety level 2 practices. In addition, these isolates must be referred to an LRN reference laboratory.

Other *Bacillus* spp. demonstrate a wide variety of colony morphologies ranging from smooth and glossy to granular and wrinkled. Colonies may range in color from creamy to greenish or orange. Overall, the *Bacillus* spp. are easily recognized despite their morphologic diversity. Identification of the various species of *Bacillus* should include the basic tests assessing spore and colony characteristics, motility, hemolysis, and the egg yolk reaction. If further identification is required for isolates other than *B. anthracis*, commercial identification systems may be used once the basic tests have been performed. Differentiating characteristics of *Bacillus* spp. are presented in Table 7-2.

Table 7-2 Differentiation of *Bacillus*^a

Species	Anaerobic growth	Motility	Lecithinase (egg yolk reaction)	Gelatin hydrolysis	Arginine dihydrolase	Nitrate reduction
<i>B. anthracis</i>	+	0	+	V	0	+
<i>B. cereus</i>	+	+	+	+	V	V
<i>B. licheniformis</i>	+	+	0	+	V	+
<i>B. megaterium</i>	0	+	0	+	0	0
<i>B. mycoides</i>	+	0	+	+	V	V
<i>B. pumilus</i>	0	+	0	+	0	0
<i>B. subtilis</i>	0	+	0	+	0	+
<i>B. thuringiensis</i>	+	+	+	+	+	+

^a+, positive reaction (≥85% positive); V, variable reaction (15 to 84% positive); 0, negative reaction (<15% positive).

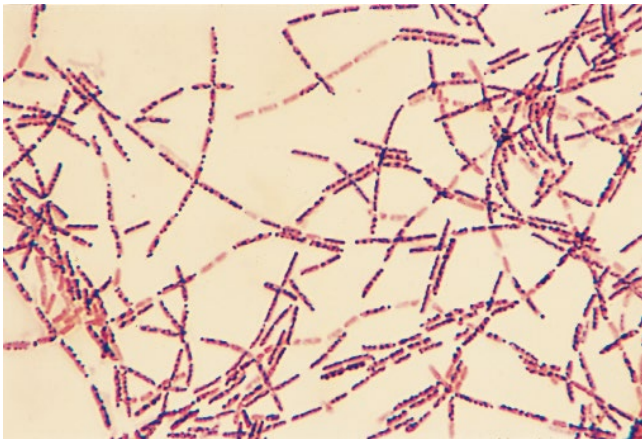


Figure 7-1 Gram stain of *Bacillus anthracis*. Gram stain of *B. anthracis*, showing cells approximately 1 to 5 μm in size occurring in long chains. The bacilli are primarily Gram positive; however, a few Gram-variable and Gram-negative cells are also present. The spores are oval and central to subterminal and do not cause significant swelling of the cell.

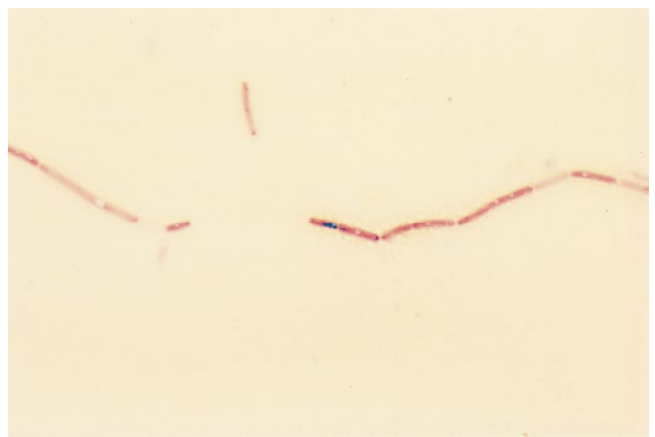


Figure 7-2 Gram stain of *Bacillus anthracis* grown on a urea agar slant. *Bacillus* spp. do not always stain Gram positive, as demonstrated here. In this example, *B. anthracis* was grown on a urea agar slant to enhance the formation of spores. This Gram-stained smear shows Gram-negative bacilli with bamboo-type joints and unstained areas suggestive of spores.

Figure 7-3 Spore stain of *Bacillus anthracis*. Spores are stained by flooding a heat-fixed smear with 10% aqueous malachite green for up to 45 min. The slide is then washed, and 0.5% aqueous safranin is applied as the counterstain for 30 s. Spores stain green and the vegetative cells are pinkish red, as shown here. (Courtesy of Orange County Health Department, Santa Ana, CA.)

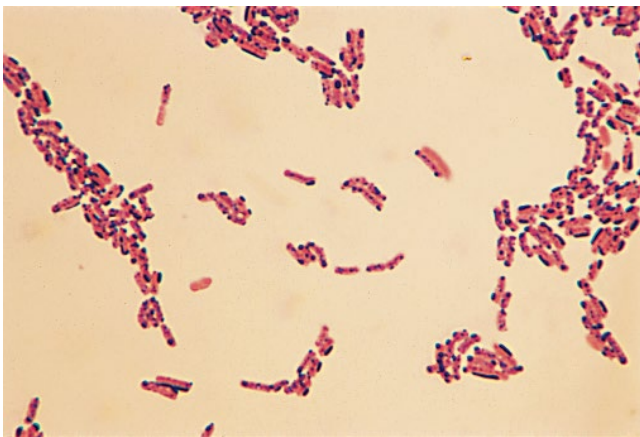


Figure 7-4 Gram stain of *Bacillus cereus*. A Gram stain of *B. cereus* showing cells similar to those of *B. anthracis* (Fig. 7-1); however, the *B. cereus* cells appear in a palisade formation rather than in long chains.

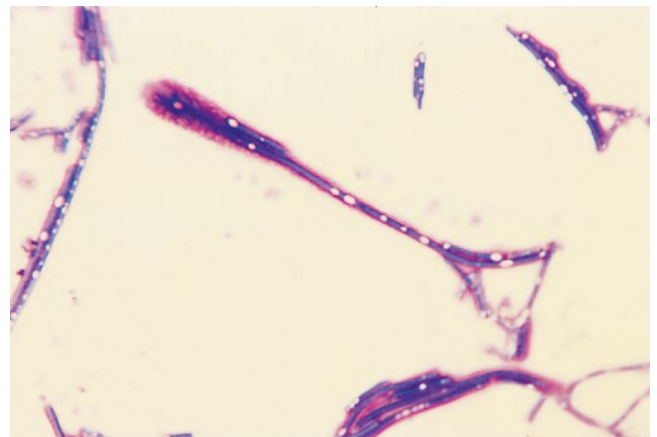


Figure 7-5 M'Fadyean stain of *Bacillus anthracis*. The M'Fadyean stain is a modification of the methylene blue stain developed for the detection of *B. anthracis* in clinical specimens. As shown here, the bacilli stain deep blue surrounded by a pink capsule; this is known as the M'Fadyean reaction.

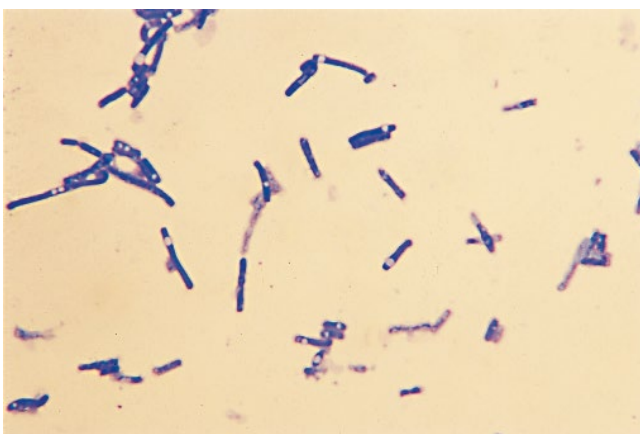


Figure 7-6 M'Fadyean stain of *Bacillus cereus*. In contrast to *B. anthracis*, cells of *B. cereus* stain deep blue but are not surrounded by a pink area because they are not encapsulated.



Figure 7-7 India ink stain of *Bacillus anthracis*. The India ink stain is used to improve visualization of encapsulated *B. anthracis* in clinical specimens, as shown here. (Courtesy of Orange County Health Department, Santa Ana, CA.)

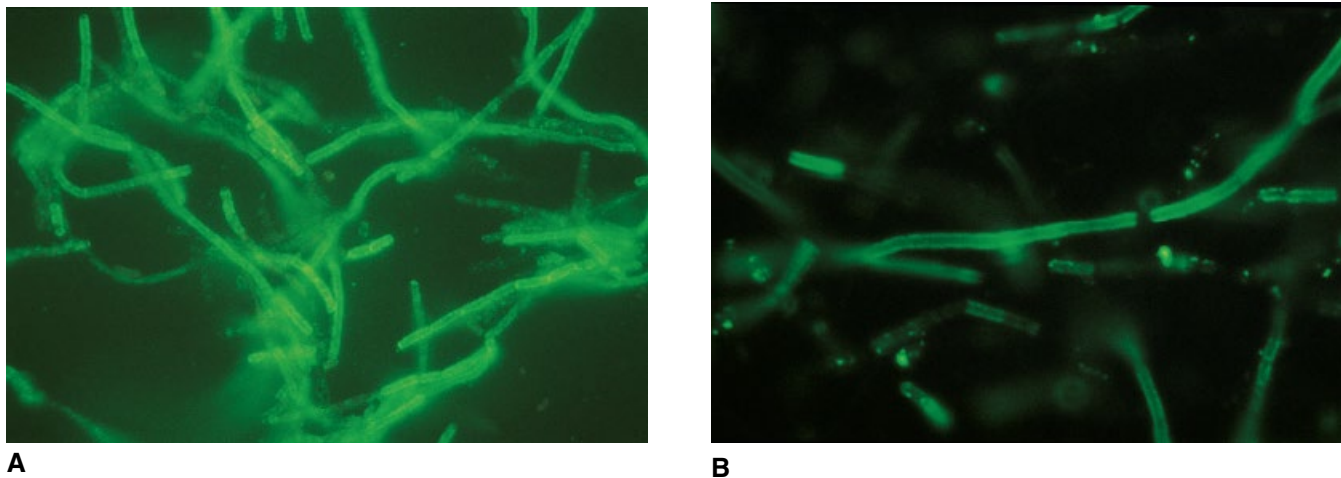


Figure 7-8 DFA assay of *Bacillus anthracis*. The DFA assay is used to detect the galactose/*N*-acetylglucosamine cell wall-associated polysaccharide and capsule produced by vegetative cells of *B. anthracis*. The availability of monoclonal antibodies recognizing the cell wall polysaccharide (A) and capsule antigens (B) provides the ability to rapidly differentiate *B. anthracis* from other *Bacillus* spp. Concomitant demonstration of both antigens confirms the identification.

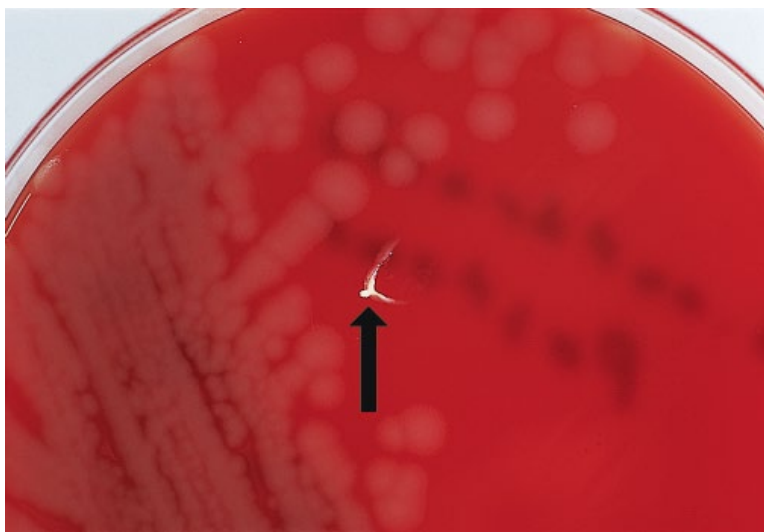


Figure 7-9 *Bacillus anthracis* on blood agar. After overnight incubation at 35°C on blood agar, colonies of *B. anthracis* measure approximately 2 to 5 mm in diameter. The flat or slightly convex nonhemolytic colonies may vary in shape from circular to irregularly round, with edges that are entire or irregular and with a matte, wavy, or ground-glass appearance. The colonies are tenacious and behave like beaten egg white when lifted with an inoculating loop, as shown above the arrow in the center of this figure. Colonies may also appear comma shaped or with “curled-hair” projections resembling a Medusa head.

Figure 7-10 *Bacillus cereus* on blood agar. *B. cereus* colonies are large (approximately 7 mm in diameter), beta-hemolytic, circular, and greenish, with a ground-glass appearance. The colonies are very similar in appearance to those of *B. anthracis*; however, *B. anthracis* colonies are slightly smaller, nonhemolytic, and very tenacious.

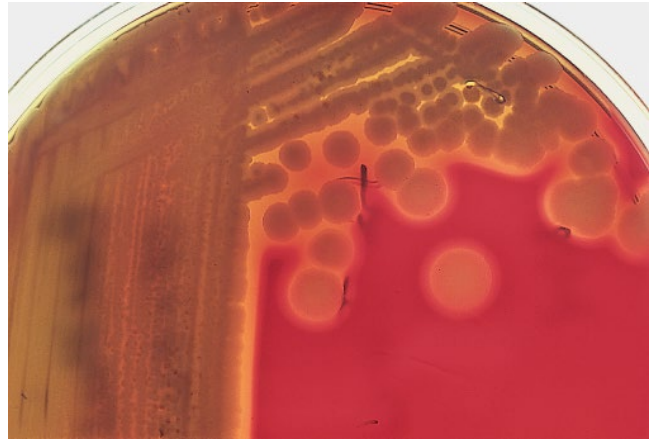


Figure 7-11 Motility test differentiating *Bacillus anthracis* from other *Bacillus* spp. Colony morphology, hemolysis, and motility are the key characteristics that differentiate *B. anthracis* from other *Bacillus* spp. To determine motility, an agar deep containing tryptose and the dye triphenyltetrazolium is inoculated with an organism and incubated at 35°C overnight. If the organism is motile, it will migrate from the inoculation or stab line. This migration is visualized with the aid of triphenyltetrazolium, which is reduced by the organism to form an insoluble red pigment (formazan). In this example, *B. anthracis* is nonmotile (left) and *B. cereus* is motile (right).

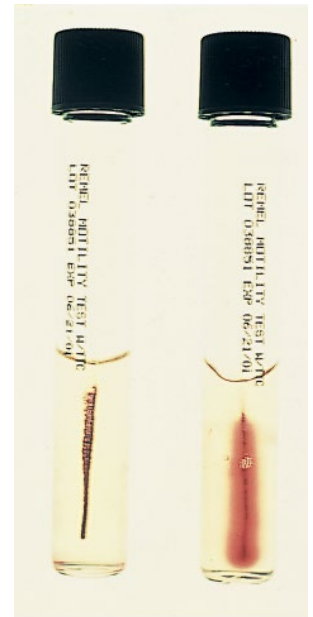


Figure 7-12 *Bacillus licheniformis* on blood agar. *B. licheniformis* derives its name from the formation of lichen-like colonies. The colonies are irregular in shape and 3 to 4 mm in size. Young colonies can appear moist, butyrous, and mucoid; they become dry, rough, and crusty as they age, giving them the licheniform appearance, as shown here. Initially they can be confused with *B. subtilis* colonies; however, the licheniform appearance distinguishes them from other *Bacillus* spp.



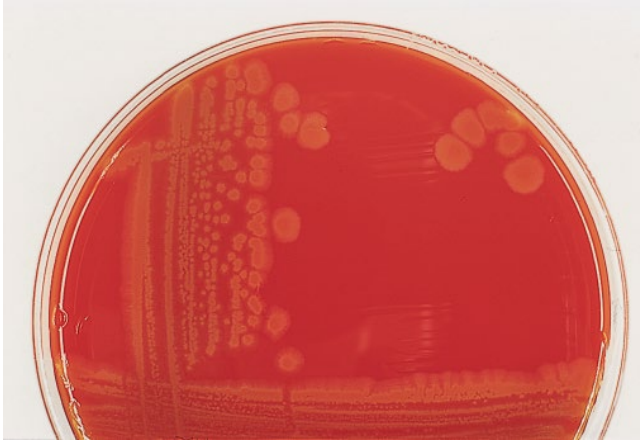


Figure 7-13 *Bacillus subtilis* on blood agar. *B. subtilis* colonies are approximately 4 to 5 mm in diameter, flat, dull, and somewhat dry, with a ground-glass appearance. The beta-hemolysis distinguishes *B. subtilis* from *B. anthracis*. The colonies are similar to those of *B. cereus* (Fig. 7-10) but usually smaller.



Figure 7-14 Egg yolk reaction of *Bacillus cereus* and *Bacillus subtilis*. *B. cereus* synthesizes lecithinases, forming opaque zones of precipitation around the colonies on egg yolk agar (left), while *B. subtilis* does not (right).



Figure 7-15 *Bacillus mycoides* on blood agar. Colonies of *B. mycoides* have a characteristic rhizoid or hairy-looking appearance, as shown in this figure. Eventually, these hairy, rhizoid, rootlike outgrowths spread across the entire plate. Unlike other *Bacillus* spp. (with the exception of *B. anthracis*), *B. mycoides* is nonmotile.

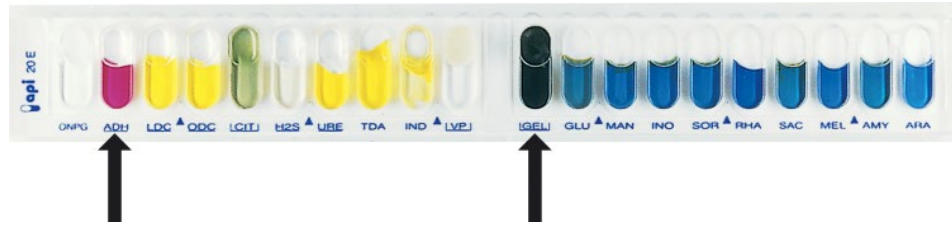


Figure 7-16 *Bacillus cereus* identified by the API 20E system. The API 20E system includes *Bacillus* spp. in its database. In this example, the arginine dihydrolase test is positive. This test rules out *B. anthracis*. Of the remaining reactions, the gelatin test is positive and the other tests are negative, confirming the identification of *B. cereus*. The positive reactions are indicated by the arrows.

Nocardia, *Rhodococcus*, *Actinomadura*, *Streptomyces*, *Gordonia*, and Other Aerobic Actinomycetes



Aerobic actinomycetes are a heterogeneous group of different genera. These organisms are classified in this group mainly on the basis of microscopic characteristics. They are Gram-positive and partially acid-fast bacilli and may have branched, filamentous hyphae that can form spores or can reproduce by fragmentation. All genera except *Lawsonella* grow better under aerobic than anaerobic conditions. The taxonomy of these organisms is currently undergoing significant changes based primarily on the application of genomic and proteomic molecular techniques. However, a more clinically relevant taxonomy may be implemented in the future. The most relevant human pathogens include *Nocardia*, *Actinomadura*, *Streptomyces*, *Rhodococcus*, *Gordonia*, and *Tsukamurella*. It is important to note that the isolation of some of these organisms from clinical specimens does not necessarily mean that they are truly pathogens, since they can be part of the commensal microbiota. Most infections are opportunistic and affect immunocompromised hosts.

Among the aerobic actinomycetes, the genus found most frequently in humans is *Nocardia*. This organism is distributed worldwide in the soil and water. Infections usually occur via the pulmonary and cutaneous routes in immunocompromised patients or those with an underlying pulmonary disease. Traumatic inoculation can occur in immunocompetent hosts. Of the more than 100 *Nocardia* species identified, those most often isolated from humans include *Nocardia asteroides*, *Nocardia abscessus*, *Nocardia brasiliensis*, *Nocardia cyriacigeorgica*, *Nocardia farcinica*, *Nocardia nova*, *Nocardia pseudobrasiliensis*, *Nocardia veterana*, and *Nocardia wallacei*. A clinically

useful classification of organisms phenotypically resembling *Nocardia asteroides* has been proposed based on antibiotic susceptibility. These organisms identified as the *N. asteroides* complex include *N. abscessus*, *N. brasiliensis*, *N. cyriacigeorgica*, *N. farcinica*, *Nocardia nana* complex, *Nocardia otitidiscaviarum*, *N. pseudobrasiliensis*, and *Nocardia transvalensis* complex.

Infection with *N. asteroides* via the pulmonary route usually results in a chronic bronchopneumonia that progresses in a matter of weeks or months and has a high mortality rate. Following a focus of pneumonitis, necrosis occurs with minimal inflammatory response. The organism may eventually disseminate to other organs, including the brain, subcutaneous tissues, and kidneys. The sputum is thick and purulent, but unlike in infections due to anaerobic actinomycetes, sulfur granules or sinus tracts are observed only rarely. Although many clinical cases of infections due to *N. asteroides* have been reported, molecular techniques have failed to support these claims. It is now considered that *N. asteroides sensu stricto* is rarely pathogenic. Many isolates identified as *N. asteroides* are currently thought to be *N. cyriacigeorgica*. Clinically relevant isolates should be identified using molecular testing and antimicrobial susceptibility profiles.

Inoculation of *N. brasiliensis* in the skin or subcutaneous tissues of the foot may result in the formation of abscesses, termed actinomycotic mycetomas (in contrast to the eumycotic mycetomas produced by fungi), that can destroy the surrounding tissues, including the bone. Sinuses are formed that drain in the skin, and the pus may contain sulfur granules that are yellow to orange

and consist of groups of organisms and calcium sulfate. Pus from draining sinuses can be used for direct examination using wet mounts. The granules can be broken between two glass slides, releasing the Gram-positive branching, interwoven thin filaments.

Nocardia spp. are aerobic, Gram-positive bacilli. However, they may appear Gram negative with Gram-positive beads and can form delicate filamentous branches, similar to fungal hyphal forms. These hyphal forms can fragment into bacillary or coccoid, nonmotile elements. The cell walls of these organisms contain mycolic acid, and as a result, they are partially acid fast. *Nocardia* spp. are catalase positive and utilize carbohydrates oxidatively.

Nocardia spp. grow relatively well on nonselective media, including blood and chocolate agars, Sabouraud's dextrose agar without chloramphenicol, and Lowenstein-Jensen or Middlebrook medium. However, *Nocardia* spp. grow slowly, and typically it takes 5 to 7 days for the colonies to appear at temperatures between 25 and 37°C. *Nocardia* spp. form aerial hyphae on culture media, and their hyphae may be visible under a dissecting microscope. The ability of *Nocardia* spp. to utilize paraffin as an energy source is a characteristic that has been used to differentiate them from other aerobic bacteria.

The genus *Rhodococcus* (red-pigmented coccus) includes more than 50 species of Gram-positive, partially acid-fast, coccobacillary, obligately aerobic actinomycetes. *Rhodococcus equi* is clinically the most important species and may cause granulomatous pneumonia in immunocompromised patients, particularly those infected with HIV-1. Cavitating lesions in the lungs frequently occur, and the organisms may disseminate to other organs, including the brain and subcutaneous tissues. This organism can be recovered from sputum, bronchoalveolar lavage fluid, lung biopsy specimens, and blood cultures. It grows well on nonselective media, although the typical salmon-pink pigment may take 3 to 5 days to appear. Biochemical characterization is difficult, and identification usually relies on colony morphology and on Gram staining showing Gram-positive coccobacilli with traces of branching and partial acid-fast properties.

The genus *Actinomadura* contains nearly 80 species, of which *Actinomadura madurae*, *Actinomadura latina*, and *Actinomadura pelletieri* may be associated with human infections, particularly in tropical regions, producing actinomycotic mycetomas. These organisms are transmitted subcutaneously from the soil, with formation of Madura foot, which leads to pus-draining sinuses. Draining sinuses are typically present in mycetomas with macroscopically visible grains (microcolonies). Progression

can result in involvement of connective tissue, muscle, and bone, which become fibrotic and deformed.

Almost 700 species are included in the genus *Streptomyces*. Streptomycetes primarily cause local, suppurative, chronic mycetomas similar to those resulting from *Actinomadura* infections. *Streptomyces somaliensis* is the most common species in this genus and is usually found in immunocompromised patients. In certain parts of the world, particularly in Africa, Mexico, and South America, *S. somaliensis* is a relatively frequent cause of actinomycotic mycetomas of the legs, head, and neck. Other *Streptomyces* spp. have recently been associated with a variety of infections, particularly in patients with AIDS. Colonies of *Streptomyces* spp. can produce a diverse range of pigments, which may result in coloration of the substrate, and aerial hyphae, although these are not produced by all the strains.

Nocardia, *Actinomadura*, and *Streptomyces* species were initially differentiated on the basis of their ability to decompose casein, tyrosine, xanthine, and starch on the Nocardia ID Quad plate (BD Diagnostic Systems, Franklin Lakes, NJ) (Table 8-1). However, it is now recommended that all clinically relevant isolates be submitted for testing using genomic and/or proteomic techniques and antibiotic susceptibility testing.

Gordonia and *Tsukamurella* spp., which are closely related to *Rhodococcus* spp., are found in the soil and are considered opportunistic human pathogens. Members of these two genera have been associated with catheter-related sepsis and cutaneous, pulmonary, and central

Table 8-1 Decomposition of substrates used for the differentiation of actinomycetes

Organism	Decomposition of ^a :				
	Casein	Tyrosine	Xanthine	Starch	Urea
<i>Actinomadura madurae</i>	+	+	0	+	0
<i>Actinomadura pelletieri</i>	+	+	0	0	0
<i>Nocardia asteroides</i>	0	0	0	0	+
<i>Nocardia brasiliensis</i>	+	+	0	0	+
<i>Nocardia otitidiscaviarum</i>	0	0	+	0	+
<i>Streptomyces somaliensis</i>	+	+	0	V	0
<i>Streptomyces anulatus</i>	+	+	+	+	V

^a+, positive reaction (>90% positive); V, variable reaction (11 to 89% positive); 0, negative reaction (<10% positive).

nervous system infections, particularly in immunocompromised patients. The colony morphology of *Gordonia* spp. ranges from smooth and mucoid to dry, and the colonies are beige to salmon pink. Rudimentary hyphae are produced by some strains, while others form aerial synnemata, which should not be confused with aerial hyphae. Synnemata (also called coremia) are groups of erect conidiophores cemented together and producing conidia at the apex and/or the sides of the upper portion. Colonies of *Tsukamurella* measure 0.5 to 2 mm in diameter and are circular, with smooth to rhizoid edges, dry and white to orange. On prolonged incubation, the colonies have a cerebroid morphology but do not produce aerial hyphae.

Other aerobic actinomycetes rarely associated with human infections include members of the genera

Dermatophilus, *Dietzia*, *Nocardiosis*, *Segniliparus*, and *Williamsia*.

The most important role of the clinical laboratory when working with aerobic actinomycetes is to assess the clinical significance of the isolate and try to differentiate between colonizers or contaminants and real pathogens. Collection of appropriate specimens, microscopic evaluation, and culture are critical for guiding therapeutic interventions. Attention should be paid to the presence of polymorphonuclear and mononuclear cells in the clinical specimens. Isolates—particularly those collected from immunocompromised patients, for whom there is clinical and laboratory evidence that it is a pathogenic aerobic actinomycete—should be forwarded to specialized laboratories to perform definitive identification and antimicrobial susceptibility testing.

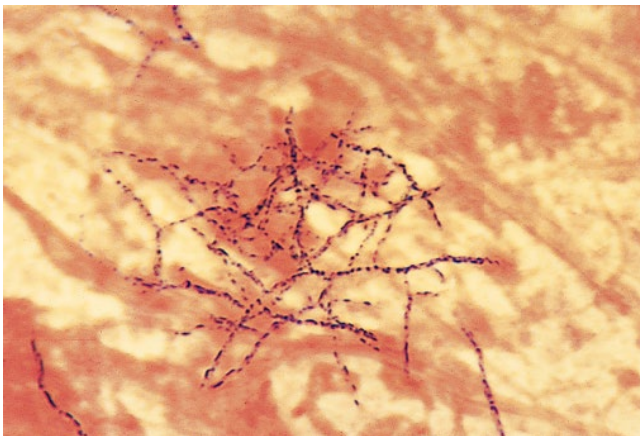


Figure 8-1 Gram stain of *Nocardia asteroides* from a tracheal aspirate. *N. asteroides* appears as thin, delicate, branching Gram-negative filaments with beaded areas and thus can resemble Gram-positive cocci.

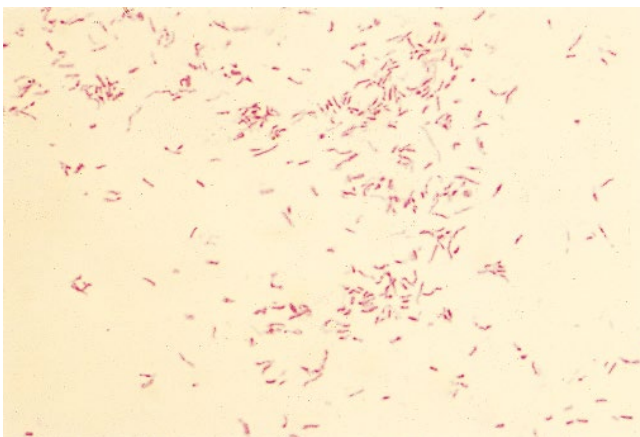
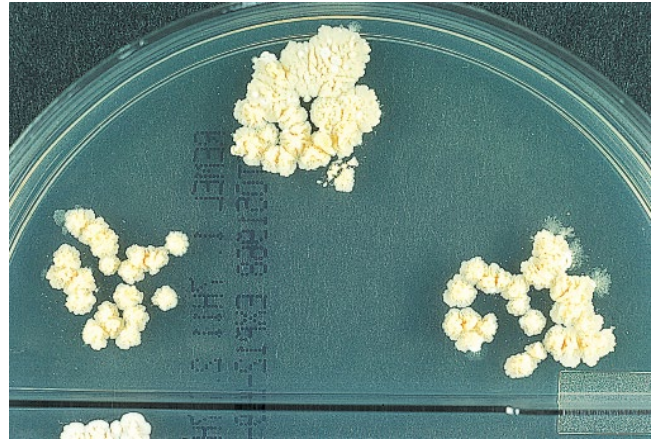


Figure 8-2 Acid-fast stain of *Nocardia asteroides*. *N. asteroides* produces long, thin, filamentous structures that are partially acid fast. In culture, as shown here, the filaments fragment.

Figure 8-3 *Nocardia asteroides* on 7H11 medium. Colonies of *N. asteroides* are highly variable in morphology, depending on the culture conditions. The color can range from chalky white, as shown here, due to the growth of aerial hyphae, to orange and salmon pink.



A



B

Figure 8-4 *Nocardia asteroides* on a Nocardia ID Quad plate. The Nocardia ID Quad plate is used to determine the ability of the organism to decompose xanthine (top left), tyrosine (bottom left), casein (top right), and starch (bottom right). (A) Organisms that can utilize these substrates produce a clear halo around the colonies. (B) Hydrolysis of starch is indicated by the presence of a colorless zone around the colonies after the quadrant is flooded with Gram's iodine. As shown here, *N. asteroides* does not decompose any of these four substrates. These plates should be observed weekly for 1 month because the organisms grow, and break down the substrates, at different rates. Production of a melanin-like pigment may occur in the quadrants containing the tyrosine and xanthine agars.

Figure 8-5 *Nocardia brasiliensis* on Sabouraud dextrose agar. Colonies of *N. brasiliensis* are typically orange-tan with a dry, crumbly consistency.

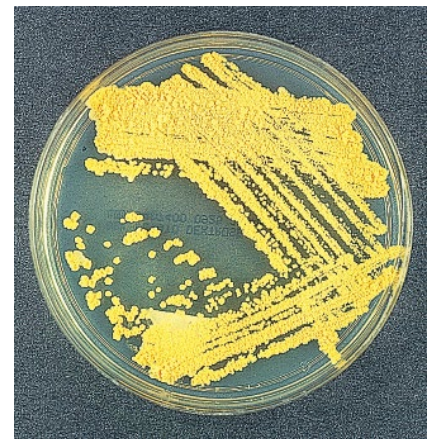




Figure 8-6 *Nocardia brasiliensis* in urea and nitrate broths. *N. brasiliensis* hydrolyzes urea (left) and reduces nitrates to nitrites or nitrogen gas (right). To perform the urease test, Christensen urea agar is inoculated and incubated at room temperature for several weeks. *Nocardia* spp. contain urease, which breaks down urea to form carbonic acid and ammonia, resulting in an increase in the pH that turns the medium red due to the phenol red present in the agar. Reduction of nitrate to nitrite results in the development of a red color due to the formation of a red diazonium dye. Negative reactions are confirmed by adding zinc dust; this should result in the appearance of a red color in 5 to 10 min, indicating that nitrate has not been reduced. If the broth remains clear after the addition of the zinc dust, it means that nitrate has been reduced to free nitrogen gas and the reaction should be considered positive.



Figure 8-7 Lysozyme test for *Nocardia brasiliensis*. Practically all members of the genus *Nocardia* can grow in the presence of lysozyme. This is in contrast to anaerobic actinomycetes, which do not grow in the presence of lysozyme. To perform this test, two tubes of sterile glycerol broth, one with lysozyme (left) and one without (right), are inoculated with the organism to be identified. As shown here for *N. brasiliensis*, the test is considered positive if the bacteria grow equally well in both tubes. If there is no growth in the tube containing lysozyme, the test is considered negative.



Figure 8-8 *Nocardia otitidiscaviarum* on Sabouraud dextrose agar. *N. otitidiscaviarum* usually produces pale tan colonies. This particular isolate has formed dried, cerebriform colonies after 2 weeks of incubation.



Figure 8-9 *Actinomadura madurae* on Sabouraud dextrose agar. Colonies of *A. madurae* can be white to pink, are usually mucoid, and, as shown here, have a molar-tooth appearance. *Actinomadura* spp. sometimes produce aerial hyphae.

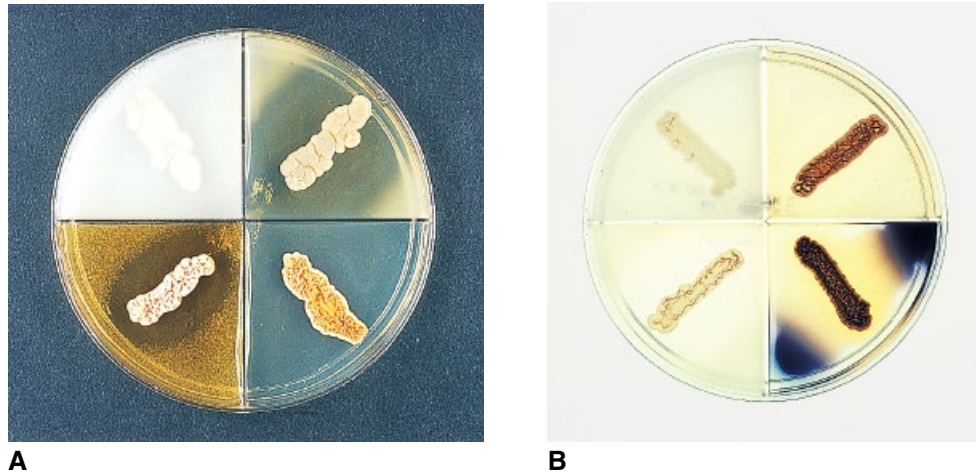


Figure 8-10 *Actinomadura madurae* on a Nocardia ID Quad plate. *A. madurae* does not break down xanthine (top left), but decomposes tyrosine (bottom left), casein (top right), and starch (bottom right) (see the legend to Fig. 8-4 for details).

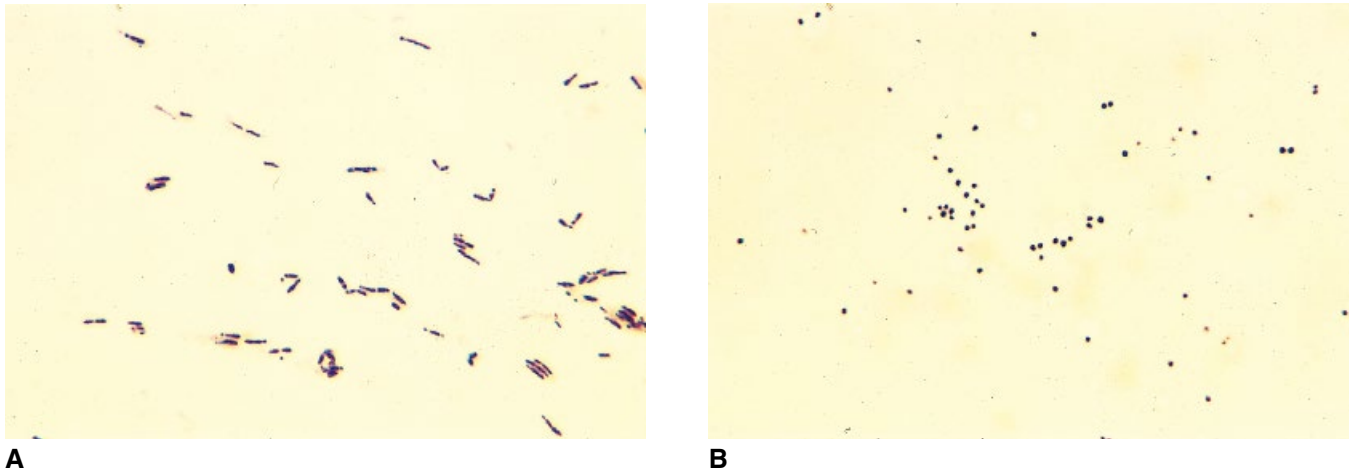


Figure 8-11 Gram stain of *Rhodococcus equi*. Depending on the culture conditions, the morphology of *R. equi* can range from bacillary to coccoid. (A) In a 24-h culture, the bacillary morphology of *R. equi* is evident. (B) After 72 h in culture, the same organism has a coccoid structure.



Figure 8-12 *Rhodococcus equi* on blood agar. Members of the genus *Rhodococcus* may have variable colony morphology, ranging from rough to smooth or mucoid. The color can also vary from buff to orange or deep rose. The isolate shown here has smooth, round colonies with a pink-orange color.

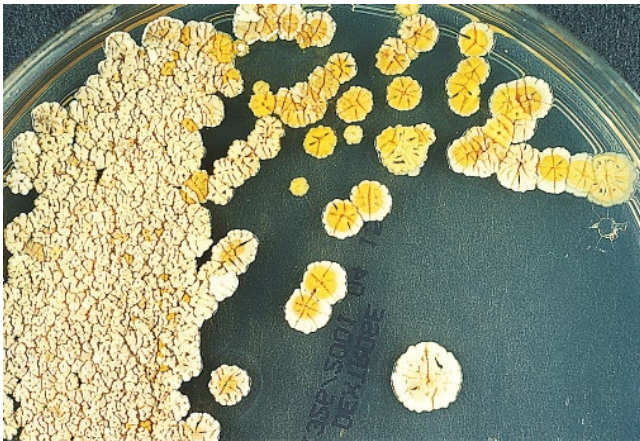
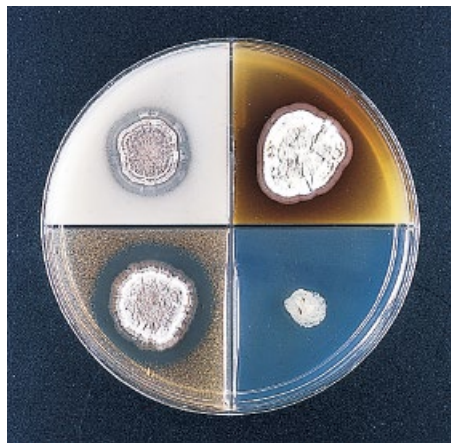


Figure 8-13 *Streptomyces* spp. on Sabouraud dextrose agar. There are many colony morphotypes due to the great variety of organisms included in this group. The colonies shown here are orange to tan, irregular, and with a smooth, rugose or warty surface due to the growth of *Streptomyces anulatus*.



A



B

Figure 8-14 *Streptomyces anulatus* on a Nocardia ID Quad plate. *S. anulatus* can decompose the substrates xanthine (top left), tyrosine (bottom left), casein (top right), and starch (bottom right), present in the Nocardia ID Quad plate (see the legend to Fig. 8-4 for details).



Figure 8-15 *Streptomyces* spp. in urea and nitrate broths. Most *Streptomyces* spp. do not produce urease and cannot reduce nitrates to nitrites, in contrast to *Nocardia* spp. (Fig. 8-6).



Figure 8-16 Lysozyme test for *Streptomyces* spp. *Streptomyces* spp. do not grow in the presence of lysozyme (left). The organism was able to grow only in the tube that did not contain lysozyme (right). This is in contrast to members of the genus *Nocardia*, which can grow in media containing lysozyme (Fig. 8-7).

Mycobacterium

9

Mycobacterium is the only genus in the family *Mycobacteriaceae* and includes more than 180 species. Based on the epidemiology and disease presentation, isolates of human relevance are divided into four major groups: *Mycobacterium tuberculosis* complex (MTBC), *Mycobacterium leprae*, *Mycobacterium ulcerans*, and the nontuberculous mycobacteria. The MTBC includes *M. tuberculosis*, *Mycobacterium bovis*, *M. bovis* BCG (bacillus Calmette-Guérin), *Mycobacterium africanum*, *Mycobacterium canettii*, *Mycobacterium caprae*, *Mycobacterium microti*, *Mycobacterium pinnipedii*, *Mycobacterium mungi*, *Mycobacterium orygis*, dassie bacillus, chimpanzee bacillus, and *Mycobacterium suricattae*. Culturable mycobacteria of clinical significance are listed in Table 9-1.

It is estimated that approximately one-third of the world's population is infected with *M. tuberculosis*, and approximately 2 million people die per year as a result of this infection. Latent tuberculosis in the United States affects ~4% of the population, and 10 to 15% of infected individuals will develop active disease in the future. The continuous increase of multidrug-resistant and extensively drug-resistant isolates of *M. tuberculosis* and the high risk of infection in HIV patients have further augmented the awareness of this disease. *M. tuberculosis* is transported by airborne particles (1 to 5 μm in size) generated mainly by patients with a productive cough. The 50% infective dose is very low (<10 acid-fast bacilli), and therefore, transmission is a significant concern.

M. bovis has a wide host range, including nonhuman primates, cattle, buffalo, goats, pigs, dogs, cats, and

some birds. The number of *M. bovis* human infections is on the rise as a result of drinking raw (unpasteurized) milk from infected cows. The *M. bovis* BCG strain is an attenuated form of *M. bovis* that has been used extensively in many parts of the world as a vaccine to protect against meningitis and disseminated tuberculosis in children. It does not prevent primary infection and reactivation. It is also utilized to treat certain tumors, e.g., those of the urinary bladder, due to its ability to stimulate the immune system. *M. africanum* and *M. canettii* are found mainly in Africa, and their epidemiology is not well characterized. *M. microti* causes infections in immunocompetent and immunocompromised humans. *M. caprae*, formerly identified as *M. tuberculosis* subsp. *caprae* and *M. bovis* subsp. *caprae*, accounts for up to 30% of cases of human tuberculosis, most with pulmonary manifestations, in certain parts of Europe. Transmission of *M. pinnipedii* from sea lions to humans has been demonstrated and results in granulomatous lesions involving the lungs, pleura, lymph nodes, and spleen.

In addition to MTBC, other slow-growing mycobacteria of human significance include the nontuberculous *Mycobacterium avium* complex (MAC), *Mycobacterium kansasii*, *Mycobacterium haemophilum*, and *Mycobacterium marinum*. The nontuberculous bacteria are ubiquitous in the environment and are found on the skin and in the respiratory and gastrointestinal tracts of healthy individuals. Routes of transmission include the respiratory and gastrointestinal tracts, and occasionally infections are iatrogenically acquired or health care

Table 9-1 Cultivable mycobacteria of clinical significance

<i>M. tuberculosis</i> complex (nonchromogens)	Slow growers		Rapid growers	
	Nontuberculous mycobacteria		Nonchromogens	Chromogens
	Nonchromogens	Chromogens		
<i>M. tuberculosis</i>	<i>M. avium</i> complex	<i>M. asiaticum</i>	<i>M. abscessus</i>	<i>M. phlei</i>
<i>M. africanum</i>	<i>M. celatum</i>	<i>M. flavescens</i>	<i>M. chelonae</i>	<i>M. vaccae</i>
<i>M. bovis</i>	<i>M. gastri</i>	<i>M. gordonae</i>	<i>M. fortuitum</i> group	
<i>M. bovis</i> BCG	<i>M. genavense</i>	<i>M. kansasii</i>	<i>M. mucogenicum</i>	
<i>M. canettii</i>	<i>M. haemophilum</i>	<i>M. marinum</i>	<i>M. smegmatis</i>	
<i>M. caprae</i>	<i>M. malmoense</i>	<i>M. scrofulaceum</i>		
<i>M. microti</i>	<i>M. shimoidei</i>	<i>M. simiae</i>		
<i>M. mungi</i>	<i>M. terrae</i> complex	<i>M. szulgai</i>		
<i>M. pinnipedii</i>	<i>M. triviale</i>	<i>M. xenopi</i>		
	<i>M. ulcerans</i>			

related. Transmission from person to person is unusual, and pathogenicity is low. Gastrointestinal manifestations usually predominate in immunocompromised patients, and blood cultures are frequently positive in this group of individuals.

The MAC includes 11 species: *M. avium*, *Mycobacterium intracellulare*, *Mycobacterium chimaera*, *Mycobacterium arosiense*, *Mycobacterium colombiense*, *Mycobacterium vulneris*, *Mycobacterium marseillense*, *Mycobacterium bouchodurhonense*, *Mycobacterium timonense*, *Mycobacterium yongonense*, and *Mycobacterium paraintracellulare*. In addition, four subspecies of *M. avium* have been described: *Mycobacterium avium* subsp. *avium*, *M. avium* subsp. *paratuberculosis*, *M. avium* subsp. *silvaticum*, and *M. avium* subsp. *hominissuis*. These mycobacteria are found readily in the environment, including water and soil, and in pigs, chickens, and cats. From the point of view of human infections, their importance has significantly increased with the HIV epidemic. MAC members are the most frequently isolated pathogenic slow-growing mycobacteria, followed by *M. kansasii*. MAC infections are common in middle-aged male smokers and postmenopausal females with bronchiectasis (Lady Windermere syndrome). These environmental organisms are frequently found in water, soil, plants, and animals, and therefore, determining their significance in pulmonary specimens requires careful clinical correlation. *M. chimaera* has been reported in several hospitals following cardiac bypass surgery. The organisms appear to be present in the heater-cooler devices used during surgery. Patients may present with prosthetic valve endocarditis, vascular graft infection, or disseminated disease 1 to 4 years after surgery.

Mycobacterium ulcerans is, after MTBC and *M. leprae*, the most common mycobacterial pathogen in humans. This organism is particularly prevalent in Africa, where the disease it causes is known as Buruli ulcer; in Australia, it is called Bairnsdale ulcer.

The noncultivable nontuberculous mycobacteria include *M. leprae*, which causes leprosy (Hansen's disease), a chronic granulomatous disease that usually manifests with anesthetic skin lesions and peripheral neuropathy. *M. leprae* cannot be cultured *in vitro*, and thus, the diagnosis is primarily based on the clinical presentation and skin biopsy. A skin test with lepromin, a preparation of the bacterial antigen, can help in the diagnosis.

Mycobacteria are straight or slightly curved aerobic bacilli that measure 1.0 to 10.0 μm by 0.2 to 0.6 μm , may branch, are nonmotile, and do not form spores, although the production of spore-like structures is controversial. *M. tuberculosis* persists in tissues for years and can reactivate, suggesting its ability to adapt to anaerobic conditions. The large amount of lipids present in the wall of the mycobacteria makes these organisms difficult to stain. Aryl methane dyes, such as fuchsin and auramine O, are used as primary stains that in the presence of phenol can penetrate the cell wall and are complexed to mycolic acid. After exposure of the cells to acid-alcohol or to strong mineral acids, a counterstain is added. The ability of these organisms to resist decoloration with up to 3% hydrochloric acid is referred to as acid-fastness. Other microorganisms that are partially acid fast include species of *Nocardia* and *Rhodococcus*, *Legionella micdadei*, and the protozoa *Isospora*, *Cyclospora*, and *Cryptosporidium*.

Respiratory tract samples are the specimens most frequently submitted for culture. Biopsy specimens, gastric aspirates, cerebrospinal fluid, and urine are also often processed in the mycobacteriology laboratory. Blood and feces are usually obtained from immunocompromised patients. Optimal recovery of mycobacteria from clinical specimens requires the inoculation of both a broth and a solid medium. Broth media have the advantage of being more sensitive and providing more rapid detection than solid media. Semiautomated systems are available that utilize a broth medium. Solid media, on the other hand, allow preliminary identification of isolates based on colony morphology and pigment production.

Lowenstein-Jensen medium can be used for the isolation of mycobacteria. It contains whole eggs, glycerol, potato flour, and salts to support the growth of mycobacteria and malachite green to inhibit the growth of contaminating bacteria. Some selective media contain additional antibiotics to minimize the growth of other bacteria. Middlebrook 7H10 and 7H11 are transparent agar-based media that, in comparison with Lowenstein-Jensen medium, have the advantages of allowing early detection of growth and microscopic examination of the morphology of the colonies by looking through the back of the plate. These media, in addition to defined salts, vitamins, and malachite green, contain some enrichment factors such as oleic acid, bovine albumin, glucose, and catalase; 0.1% casein hydrolysate is added to 7H11 to improve the recovery of isoniazid-resistant strains of *M. tuberculosis*.

Mycobacteria are classified as rapid growers (such as the *Mycobacterium fortuitum* group, the *Mycobacterium chelonae-Mycobacterium abscessus* complex, and *Mycobacterium mucogenicum*) if they produce visible colonies in less than 7 days and as slow growers (e.g., MAC, *M. kansasii*, *M. haemophilum*, and *M. marinum*) if they form colonies in 2 to 8 weeks (Table 9-1). The growth rate depends on the species of mycobacteria and is influenced by the media and the temperature of incubation. According to their photoreactive characteristics, mycobacteria are categorized into three groups. Species that produce yellow to dark orange carotene pigment in response to light are called photochromogens, while those that produce pigment independent of the amount of light are termed scotochromogens. Species that do not produce pigment, such as *M. tuberculosis*, have a buff color and are classified as nonchromogens.

Specimens from normally sterile tissues can be ground in sterile 0.85% saline or 0.2% bovine albumin and

then directly inoculated onto the media. Samples from contaminated tissues need to be treated with the mildest decontaminating procedures that control the contaminants. The most common decontaminant used is sodium hydroxide, which serves both as a mucolytic agent and as a decontaminant. However, mycobacteria are also susceptible to sodium hydroxide, and therefore, it needs to be used with caution after careful testing. All procedures that result in aerosol formation should be conducted in a class II biosafety cabinet and manipulation of cultures should be performed under biosafety level 3 conditions. Maximum precautions need to be taken to protect health care workers and to prevent specimen contamination.

The most rapid method to diagnose tuberculosis is staining with carbol-fuchsin sputum smears by the Ziehl-Neelsen or the Kinyoun procedure. Alternatively, fluorescent dyes that are more sensitive, such as auramine O alone or in combination with rhodamine B, can be used. It is recommended to collect three smears within a 24-h period. The first one should be collected early in the morning. With the first smear, ~90% of patients can be identified as acid-fast bacillus smear positive, and the other two smears add ~8% and 3% positive patients, respectively. The number of acid-fast bacilli should be reported. The use of sputum smears, or a combination of smears and nucleic acid amplification techniques, is recommended to determine when to discontinue respiratory isolation in hospitals.

All cultures for mycobacteria should be incubated at 37°C under 5 to 10% CO₂ for 6 to 8 weeks. In addition, specimens from skin lesions should be incubated at 30°C, because pathogens such as *M. marinum*, *M. haemophilum*, *M. chelonae*, and *M. ulcerans* grow better at lower temperatures. To recover *M. haemophilum*, a chocolate agar medium should also be included, since this organism requires hemin or hemoglobin for growth. Culture systems that use liquid media are now available commercially.

Historically, identification of mycobacteria relied on growth rates, colony morphology, pigmentation, and biochemical tests. Biochemical tests for the identification of mycobacteria are listed in Table 9-2, and they should be applied in conjunction with molecular assays. DNA probes are commercially available to identify MTBC, MAC, *M. avium*, *M. intracellulare*, *Mycobacterium gordonae*, and *M. kansasii*. Probes for the MTBC cannot differentiate between *M. tuberculosis*, *M. bovis*, *M. bovis* BCG, *M. africanum*, *M. microti*,

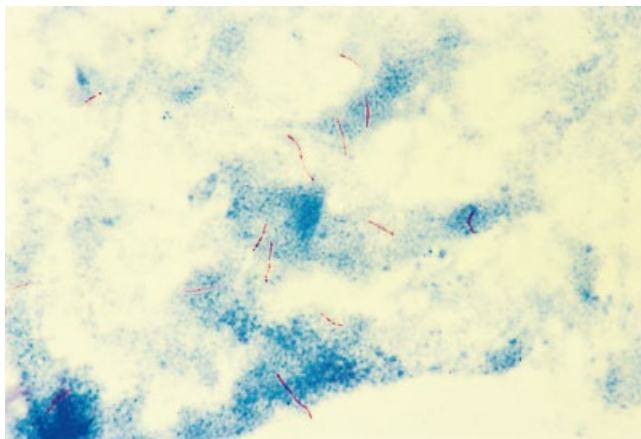
Table 9-2 Useful tests for the identification of mycobacteria

Test ^a for:			
Nonchromogens	Photochromogens	Scotochromogens	Rapid growers
Arylsulfatase	Arylsulfatase at 28°C	Arylsulfatase at 42°C	Arylsulfatase
Catalase	Catalase	Catalase	Catalase
NaCl tolerance	Growth rate at 28°C	Growth rate at 42°C	Iron uptake
Niacin	Niacin	NaCl tolerance	NaCl tolerance
Nitrate reduction	Nitrate reduction	Nitrate reduction	Nitrate reduction
PZA	Pigment	Pigment at 25°C	MacConkey without CV
Tween 80 hydrolysis	Tween 80 hydrolysis	Tween 80 hydrolysis	Utilization of sodium citrate, inositol, and mannitol
Urease		Urease	
T2H			

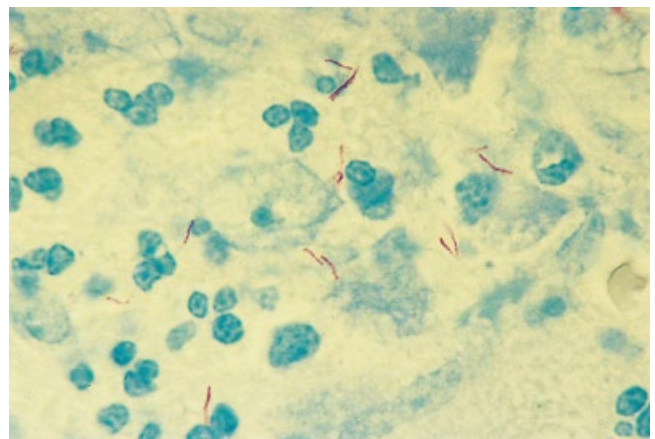
^aPZA, pyrazinamidase; CV, crystal violet; T2H, thiophene-2-carboxylic acid hydrazide.

and *M. canettii*. Compared with culture and biochemicals, the probes for identification from culture have sensitivities and specificities greater than 99%. Nucleic acid amplification techniques are performed in some laboratories for the detection and identification of mycobacteria directly from clinical specimens. The specificity and sensitivity of these techniques, however, are still under investigation. Whole-genome sequencing, matrix-assisted laser desorption ionization-time of flight mass spectrometry, and high-performance liquid chromatography for the identification of mycobacteria are available and are replacing traditional identification methods.

The most frequently utilized immunodiagnostic test for the diagnosis of tuberculosis is the tuberculin skin test. This test has shortcomings, though, including the inability to distinguish active tuberculosis from past sensitization with BCG and cross-reactivity with non-tuberculous mycobacteria. The gamma-interferon release assays are able to overcome some of these shortcomings. These assays determine T-cell gamma-interferon responses to two or three antigens that are found only in *M. tuberculosis*, *Mycobacterium szulgai*, *M. kansasii*, and *M. marinum*. These tests are mainly used to detect latent tuberculosis and not active tuberculosis.



A



B

Figure 9-1 Kinyoun stain of *Mycobacterium tuberculosis*. In sputum (A) and tissue (B) specimens stained by carbol fuchsin methods, such as those involving Ziehl-Nielsen and Kinyoun stains, *M. tuberculosis* appears as red-purple, curved, short or long bacilli, ranging from 1.0 to 10.0 μm by 0.2 to 0.6 μm , against a blue or a green background.

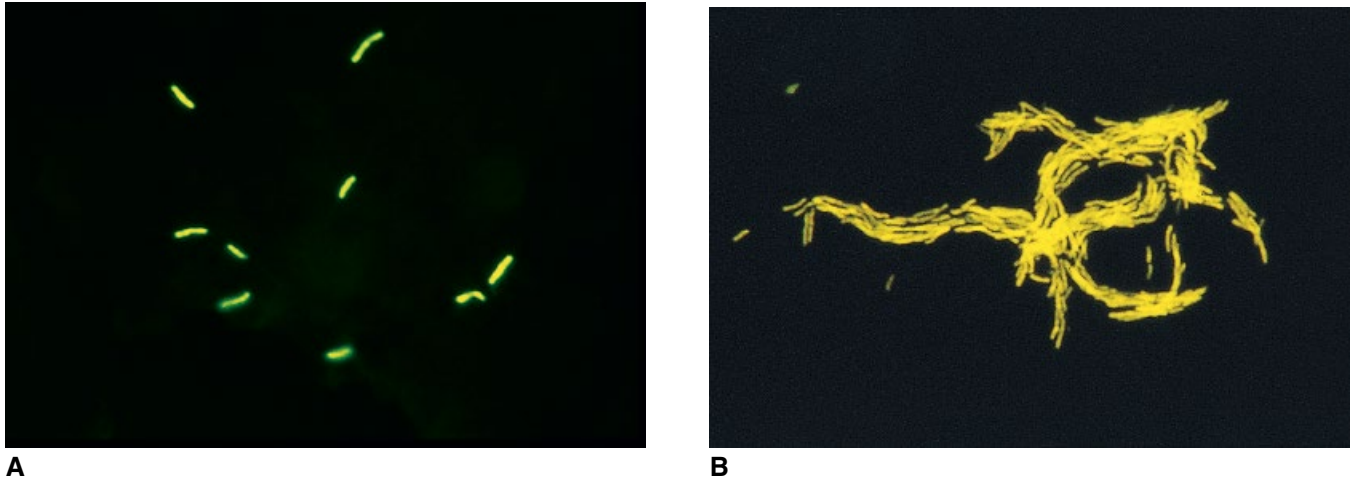


Figure 9-2 Auramine stain of *Mycobacterium tuberculosis*. (A) With the two fluorochromes commonly used, auramine O and auramine-rhodamine, *M. tuberculosis* fluoresces yellow to orange, depending on the microscope filters used. The fluorescent stains are more sensitive and have the advantage that the specimen can be screened at low magnification. According to some authors, one of the shortcomings of the fluorescence methods is that some of the rapid growers may not stain. For this reason, they recommend counterstaining the smear with the Ziehl-Neelsen or Kinyoun stain when rapid growers are suspected. (B) Following incubation in liquid medium, *M. tuberculosis* organisms form large serpentine cord formation.

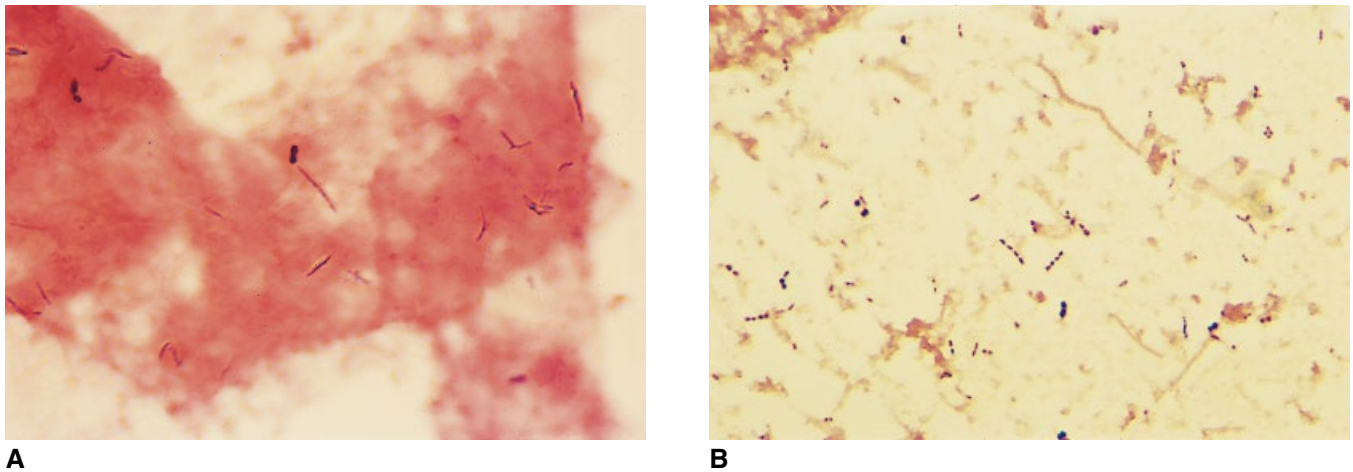


Figure 9-3 Gram stain of *Mycobacterium tuberculosis*. Mycobacteria are considered Gram positive, although they are usually not easily stained by this method. (A) This Gram stain of a sputum sample shows that mycobacteria may stain faintly or not at all, producing a “ghost-like” image. (B) Sometimes, however, they appear as beaded Gram-positive bacilli.

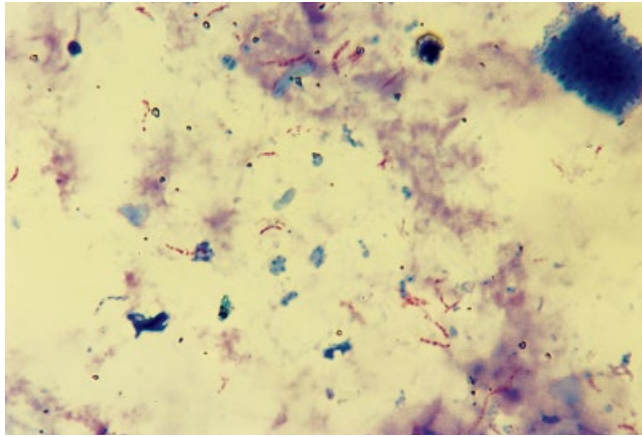
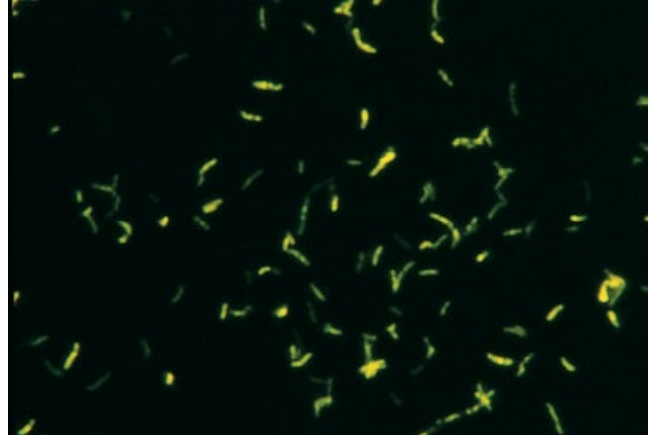
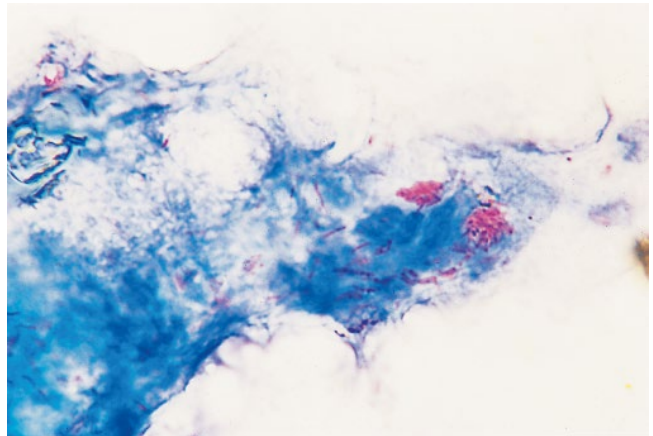
**A****B**

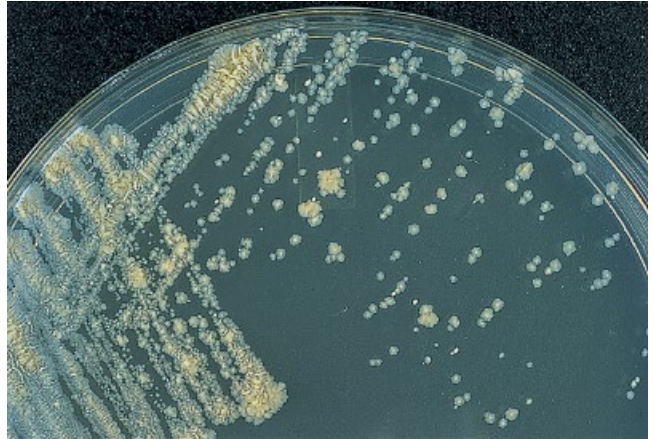
Figure 9-4 Kinyoun and auramine stains of *Mycobacterium avium*-*Mycobacterium intracellulare*. (A) *M. avium*-*M. intracellulare* has a beaded appearance when stained by the Kinyoun method. (B) In liquid medium, these organisms remain as single cells and do not form serpentine cords as does *M. tuberculosis*.

Figure 9-5 *Mycobacterium leprae* stained by the Fite-Faraco method. *M. leprae* is only partially acid fast and thus stains weakly, if at all, with the standard acid-fast stains. For this reason, it is recommended to use the Fite-Faraco stain.

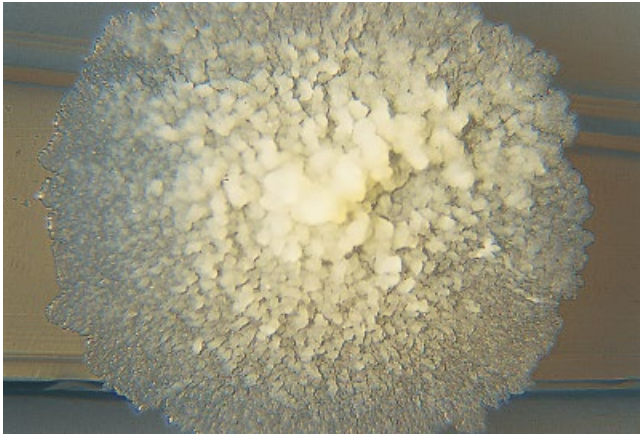




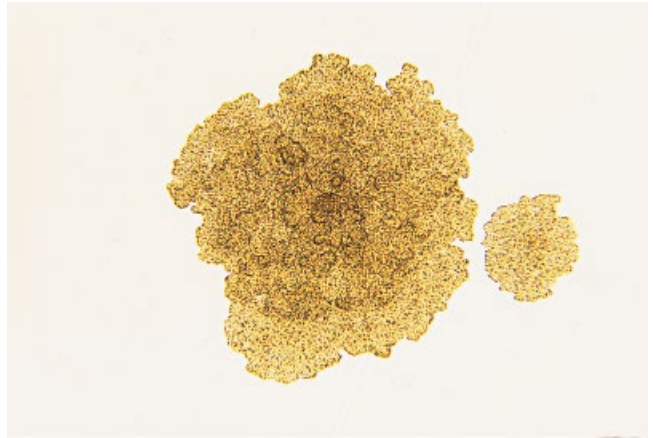
A



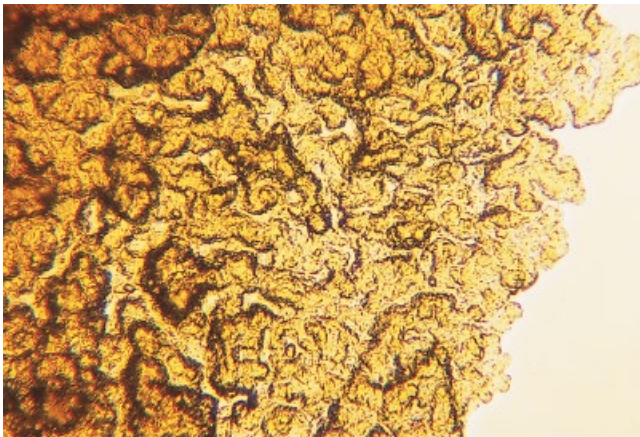
B



C



D



E

Figure 9-6 *Mycobacterium tuberculosis* on a Lowenstein-Jensen agar slant (A) and on Middlebrook 7H11 agar (B to E). (A to C) Colonies of *M. tuberculosis* are dry, wrinkled, rough, thin, and friable with an irregular periphery and buff color. (D and E) When the colonies on Middlebrook agar are examined from the reverse side with transmitted light, cording can be observed at low magnification and is more apparent in older colonies and at higher magnification.



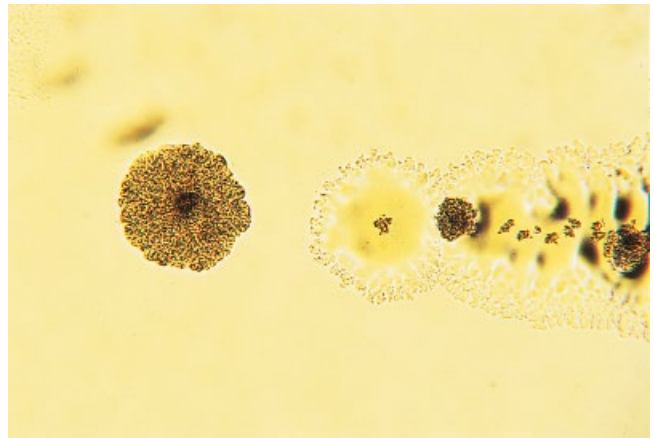
A



B



C



D

Figure 9-7 *Mycobacterium avium-Mycobacterium intracellulare* on a Lowenstein-Jensen agar slant (A) and on Middlebrook 7H11 agar (B to D). (A) *M. avium-M. intracellulare* organisms grow very slowly on Lowenstein-Jensen agar, and it usually takes 3 to 4 weeks before the colonies are clearly visible. (B) As shown in this Middlebrook 7H11 agar culture, most strains of *M. avium-M. intracellulare* grow with mixed colony morphology. Like *M. tuberculosis* colonies, they are buff colored; however, they are significantly smaller than *M. tuberculosis* colonies. (C) Smooth-domed, round, entire, transparent, nonpigmented, and glistening colonies can be observed. Rough and wrinkled colonies similar to those produced by *M. tuberculosis* are also frequently present. (D) When observed from the reverse side with transmitted light, colonies may have a rough, dry, wrinkled, sunspot appearance or smooth translucent edges with a buff-colored center.

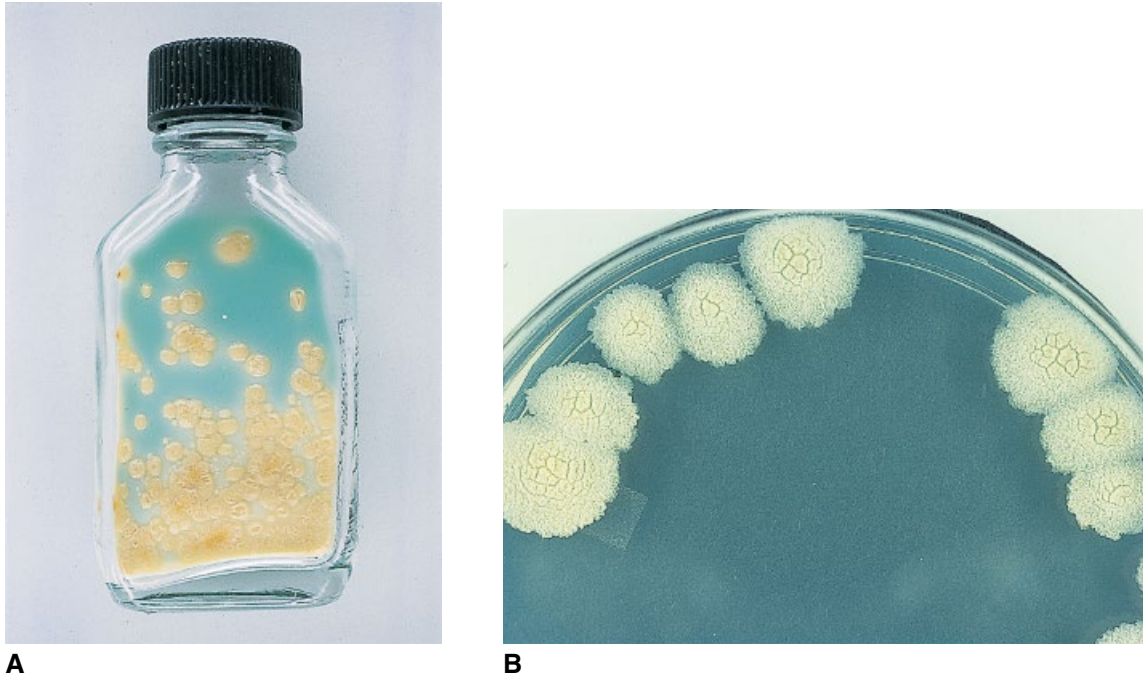
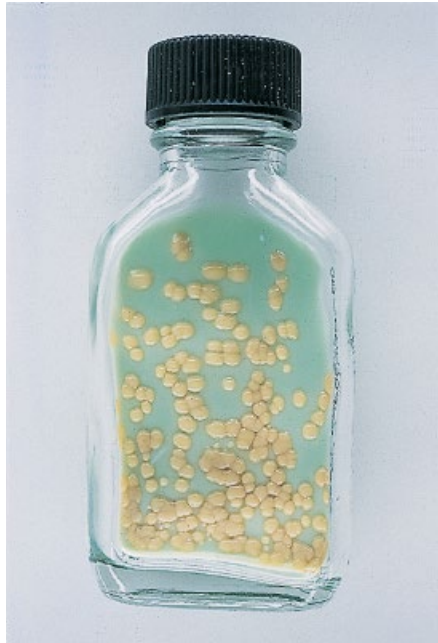


Figure 9-8 *Mycobacterium abscessus* on a Lowenstein-Jensen agar slant (A) and on Middlebrook 7H11 agar (B). *M. abscessus* rapidly forms large, rounded, entire or scalloped, smooth colonies with a dark buff color. Occasionally rough, wrinkled colonies are also found. This organism is present in tap water and has been associated with several injection- and catheter-related outbreaks of health care-related infections. In addition, it can produce pulmonary and disseminated cutaneous lesions, particularly in immunosuppressed patients.



A



B



C

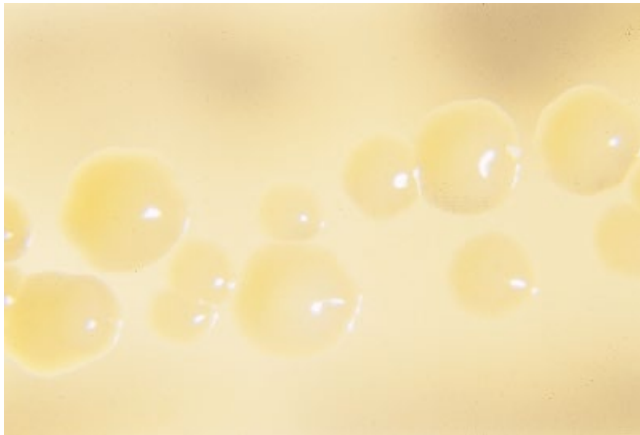
Figure 9-9 *Mycobacterium chelonae* on a Lowenstein-Jensen agar slant (A and B) and on Middlebrook 7H11 agar (C). (A and C) *M. chelonae* is a rapid grower that produces domed, round, smooth, glistening, buff-colored colonies with thin, irregular edges in 2 to 4 days. (B) It may also produce rough, wrinkled colonies, depending on the strain. Clinically, *M. chelonae* is frequently associated with a disseminated nodular skin disease in immunocompromised individuals.



A



B



C



D

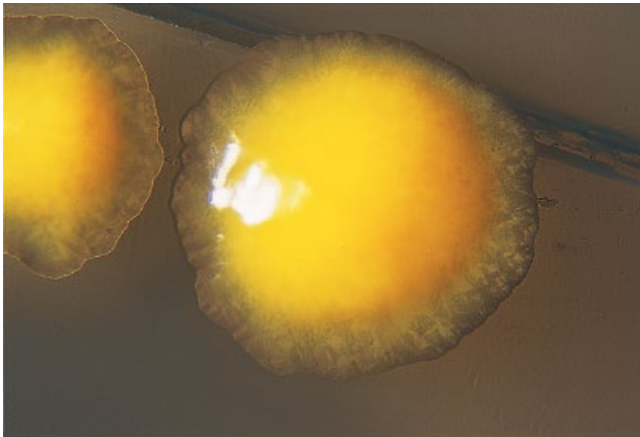
Figure 9-10 *Mycobacterium fortuitum* on a Lowenstein-Jensen agar slant (A) and on Middlebrook 7H11 agar (B to D). Depending on the strain, smooth or rough colonies of *M. fortuitum* may grow in 2 to 4 days on Middlebrook medium. (A and C) The smooth colonies shown here on the Lowenstein-Jensen agar slant and at higher magnification on the 7H11 agar are circular, convex, smooth, glistening, entire, and buff. (B and D) Rough, wrinkled colonies can also be observed on Middlebrook 7H11 agar. *M. fortuitum* usually causes infection secondary to a penetrating injury, such as trauma or surgical procedure, associated with contaminated water or soil.



A



B



C



D

Figure 9-11 *Mycobacterium gordonae* on a Lowenstein-Jensen agar slant (A) and on Middlebrook 7H11 agar (B to D). (A and B) *M. gordonae* (referred to as the tap water bacillus) produces round, smooth, convex, entire, glistening, yellow to orange colonies. Pigmentation appears in the absence of exposure to light. (C) Under higher magnification, the colonies are dense with a smooth edge. (D) Reverse side of a colony of *M. gordonae* illuminated with transmitted light. *M. gordonae* is frequently found in water and soil but rarely causes disease in humans.

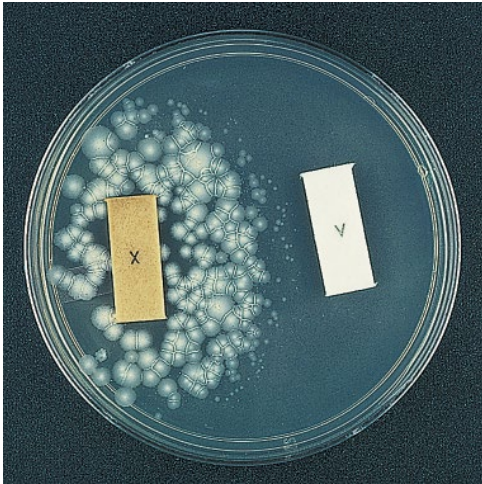


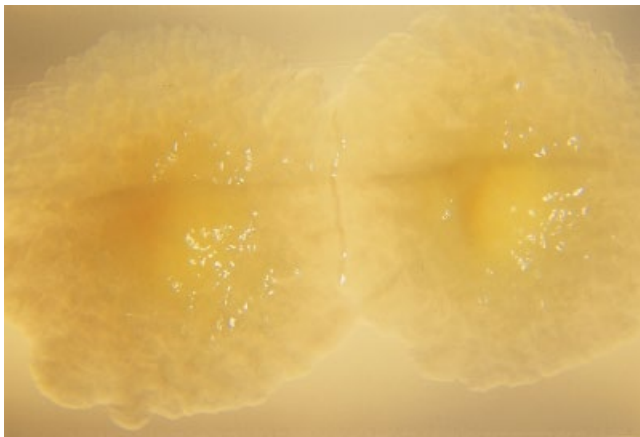
Figure 9-12 *Mycobacterium haemophilum* on Middlebrook 7H11 agar. A unique characteristic of *M. haemophilum* is that it requires hemin or hemoglobin for growth. On this plate, the organism grows next to the strip containing X factor but does not grow next to the strip containing V factor. The colonies shown here are smooth, round, and nonpigmented. This mycobacterium is usually isolated from immunocompromised patients, particularly those with AIDS.



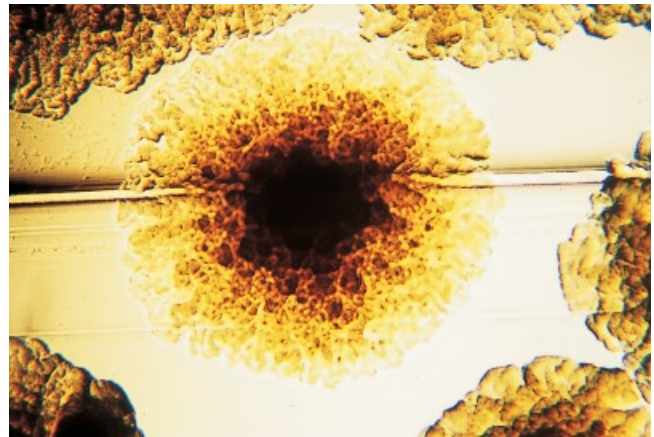
A



B



C



D

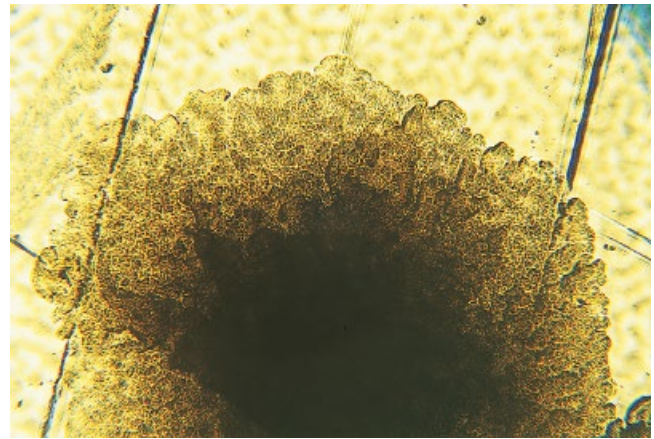
Figure 9-13 *Mycobacterium kansasii* on Lowenstein-Jensen agar slants (A) and on Middlebrook 7H11 agar (B to D). (A) Colonies of *M. kansasii* are usually smooth, domed, and yellow when exposed to light (left) and buff with thin irregular edges when grown in the dark (right). (B and C) They can also be rough and wrinkled with wavy edges and a dark center containing β -carotene crystals. (D) The dark center can easily be seen by looking at the back of the plate with transmitted light. *M. kansasii* is one of the most common causes of nontuberculous mycobacterial pulmonary disease in humans and is isolated more frequently from individuals with AIDS or organ transplants than from the general population.



A



B



C

Figure 9-14 *Mycobacterium marinum* on a Lowenstein-Jensen agar slant (A) and on Middlebrook 7H11 agar (B and C). (A) Overall, the colonies of this microorganism are irregular, with thin, trailing edges and a buff color that turns yellow following exposure to light. (B and C) The colonies of *M. marinum* shown here are rough and wrinkled (the front of the colony [B] and the back of the transilluminated colony [C] are shown). Occasionally some strains produce smooth colonies. This organism should be suspected in individuals who sustained skin trauma while in contact with freshwater (swimming pool granuloma or fish tank granuloma) or salt water.

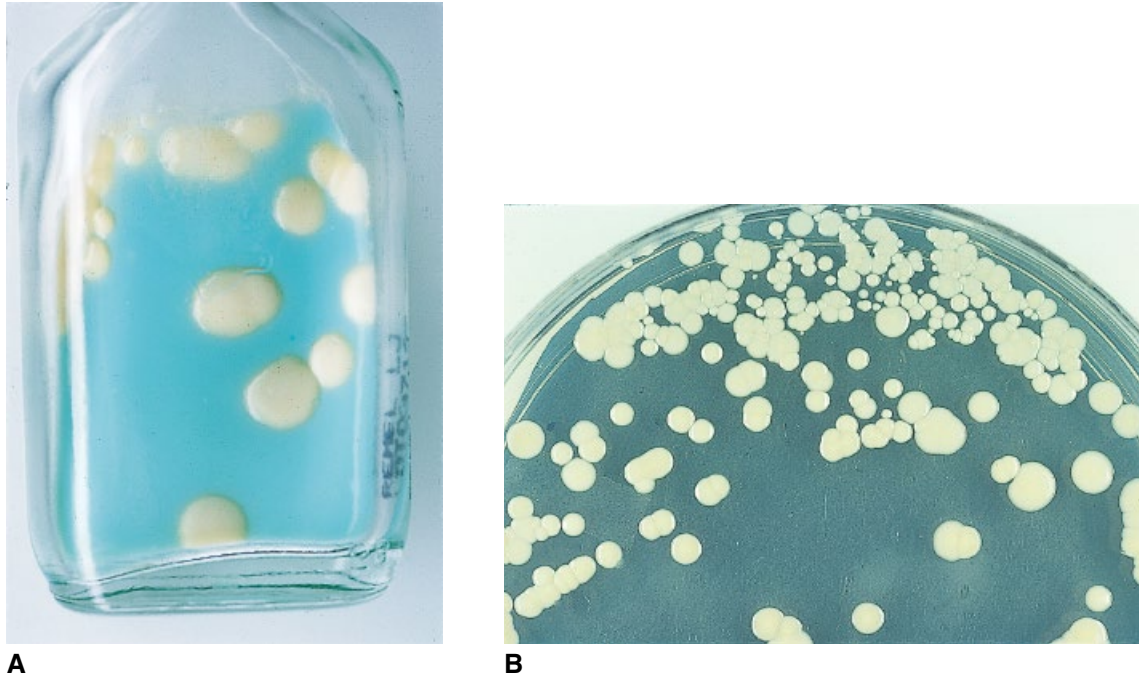


Figure 9-15 *Mycobacterium mucogenicum* on a Lowenstein-Jensen agar slant (A) and on Middlebrook 7H11 agar (B). This organism typically produces large, smooth, very mucoid colonies with a buff color, as shown here. It used to be known as *M. chelonae*-like organism and is frequently isolated from tap water. *M. mucogenicum* causes catheter-related sepsis and posttraumatic wound infections. Isolation of this organism from a single sputum sample is usually not clinically significant.

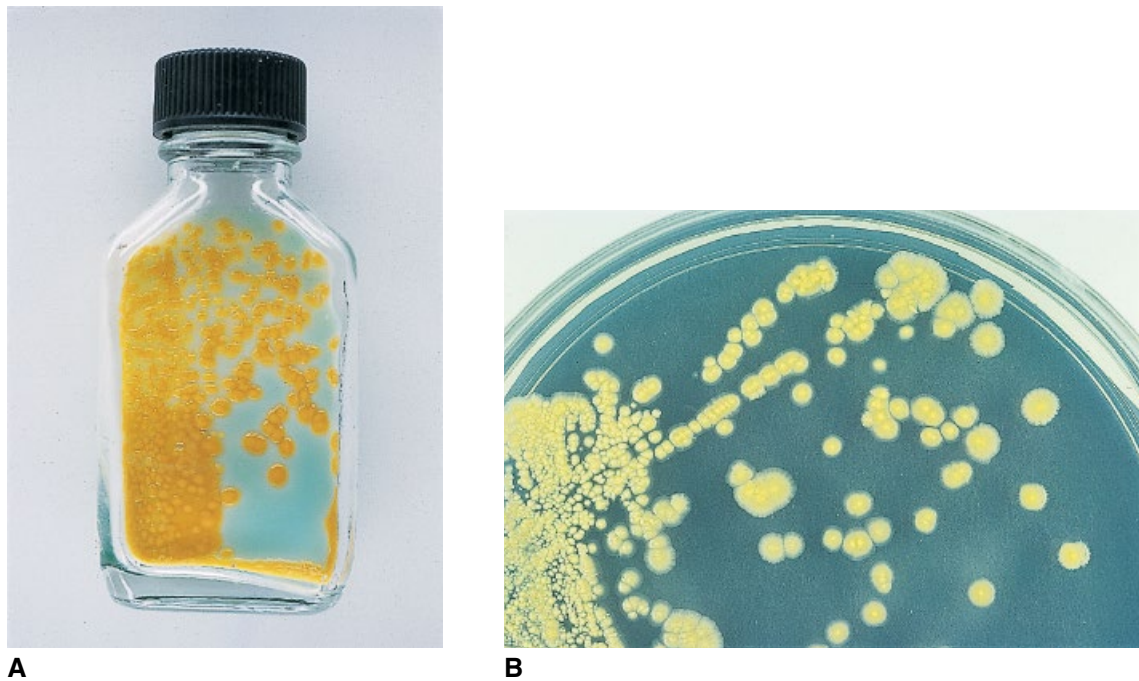


Figure 9-16 *Mycobacterium scrofulaceum* on a Lowenstein-Jensen agar slant (A) and on Middlebrook 7H11 agar (B). *M. scrofulaceum* produces smooth, round, moist, glistening colonies with elevated centers and a light yellow color that can become dark orange, depending on the strain. This organism is a slow grower and usually takes 3 to 4 weeks to form distinct colonies. It is most commonly isolated from children younger than 5 years with cervical lymphadenitis.

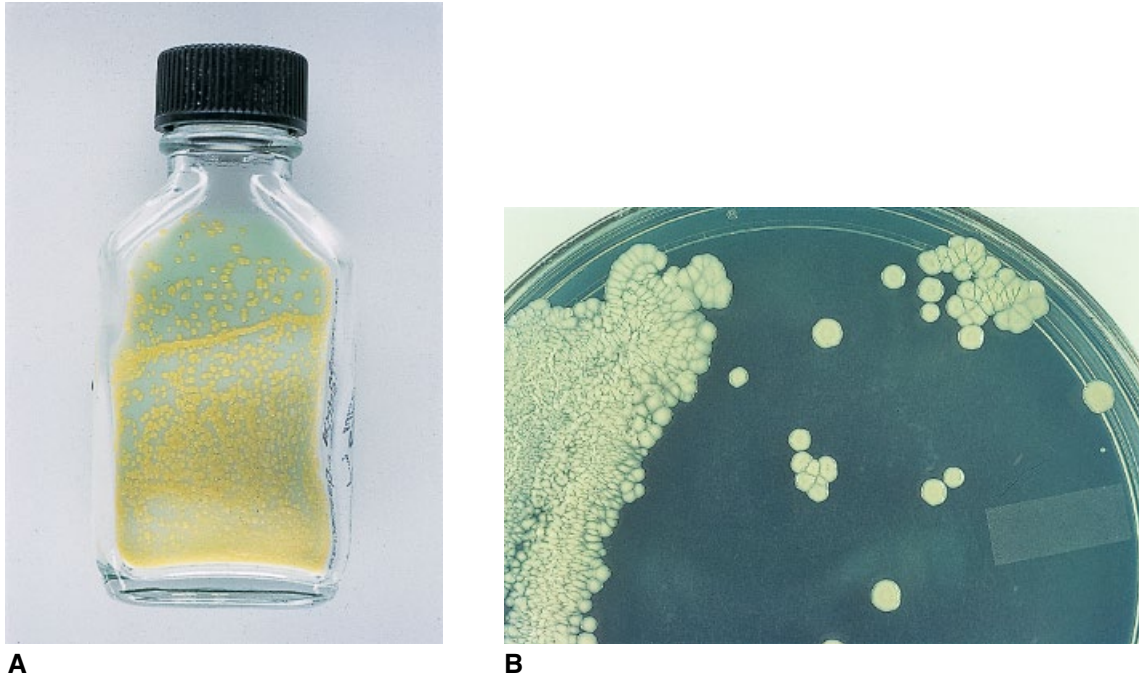


Figure 9-17 *Mycobacterium simiae* on a Lowenstein-Jensen agar slant (A) and on Middlebrook 7H11 agar (B). *M. simiae* produces smooth, domed, round, glistening colonies that change from buff to light yellow when exposed to light. Originally isolated from monkeys, it has now been found in a few humans with a clinical presentation similar to that caused by *M. avium*-*M. intracellulare* complex in patients with AIDS.

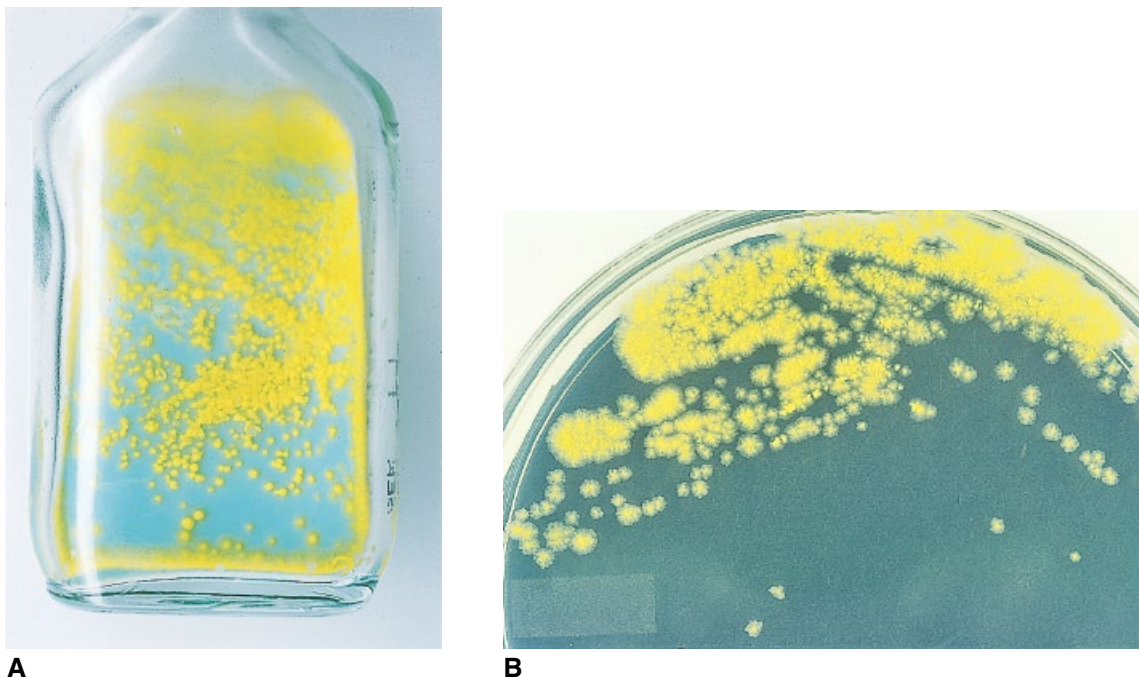
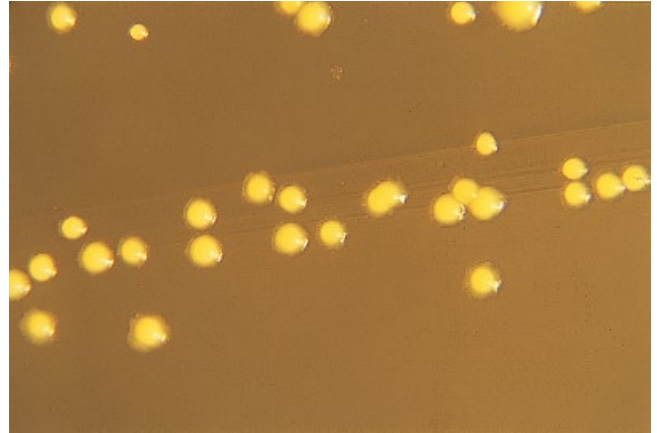


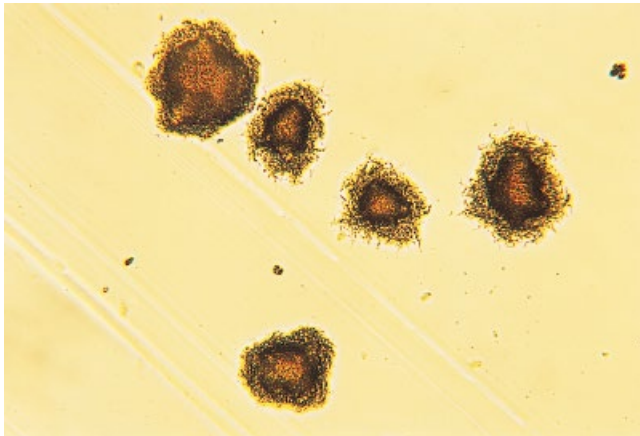
Figure 9-18 *Mycobacterium szulgai* on a Lowenstein-Jensen agar slant (A) and on Middlebrook 7H11 agar (B). *M. szulgai* forms small, buff-colored colonies that range from smooth to rough. This organism is scotochromogenic when grown at 37°C and photochromogenic when grown at 25°C. It causes a chronic pulmonary disease similar to tuberculosis in middle-aged men.



A



B



C

Figure 9-19 *Mycobacterium xenopi* on a Lowenstein-Jensen agar slant (A) and on Middlebrook 7H11 agar (B and C). (A and B) *M. xenopi* produces small, round, smooth, yellow colonies. (C) Microscopic examination of the reverse side of a young colony on Middlebrook media with transmitted light reveals a typical bird's nest appearance, with stick-like projections. This is particularly evident when the organism is grown at 45°C. Originally isolated from the African frog *Xenopus laevis*, *M. xenopi* is now found all over the world in individuals with predisposing conditions, such as diabetes mellitus, chronic lung problems, malignancy, and alcoholism.

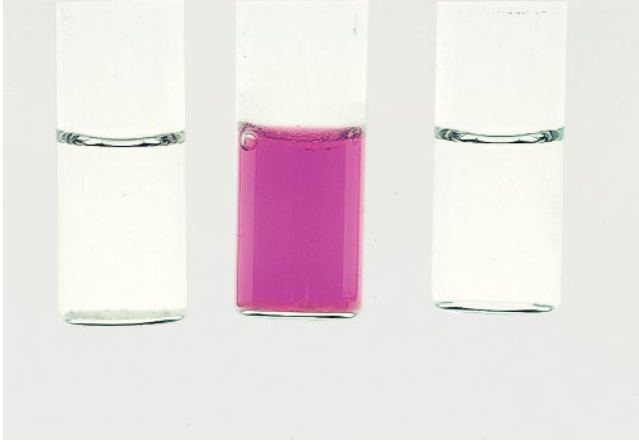


Figure 9-20 Arylsulfatase test. The enzyme arylsulfatase, present in most *Mycobacterium* species, breaks down tripotassium phenolphthalein disulfate into phenolphthalein, which in the presence of sodium carbonate, as a result of a pH change, yields a red color, as shown in the tube in the center. The 3-day test is used to identify rapid growers, while 14 days may be required for the identification of slow growers. *M. chelonae* and *M. fortuitum* give a positive reaction in less than 3 days, while *M. szulgai*, *Mycobacterium smegmatis*, *Mycobacterium asiaticum*, and *Mycobacterium flavescens* may be positive in the 14-day test. *M. xenopi* and *Mycobacterium triviale*, although slow growers, may give a positive reaction in 3 days. The tube on the left is a control uninoculated tube, the tube in the center contains *M. fortuitum* (positive), and the one on the right contains *M. avium* (negative).

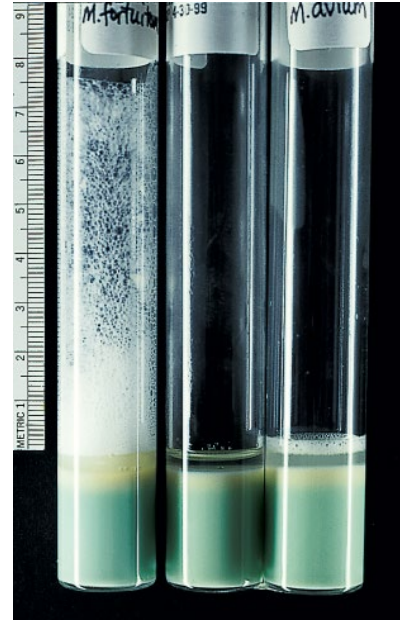


Figure 9-21 Catalase test. In general, mycobacteria possess catalase, except for *Mycobacterium gastri*, some isoniazid-resistant mutants of *M. tuberculosis* and *M. bovis*, and some nonpathogenic isoniazid-resistant strains of *M. kansasii*. In this test, catalase splits hydrogen peroxide to water and oxygen. The height of the oxygen bubbles produced allows mycobacteria to be classified into two groups: those that produce a column of bubbles less than 45 mm in height and those that produce one higher than 45 mm. This test can further help subdivide mycobacteria based on the thermostability of the catalase. Some mycobacteria have a catalase that is thermostable up to 68°C for 20 min, while other catalases are thermolabile under these conditions. Here, *M. fortuitum* (left) produced a column of bubbles higher than 45 mm, while *M. avium* generated a column less than 45 mm high (right). The tube in the center is an uninoculated control.

Figure 9-22 Growth on MacConkey agar without crystal violet. MacConkey agar without crystal violet is used to differentiate rapidly growing, potentially pathogenic mycobacteria from nonpathogenic ones. As shown here, members of the *M. fortuitum* complex usually grow on this medium, while rapidly growing, nonpathogenic mycobacteria do not. Rarely, *M. smegmatis* can also grow on this medium.

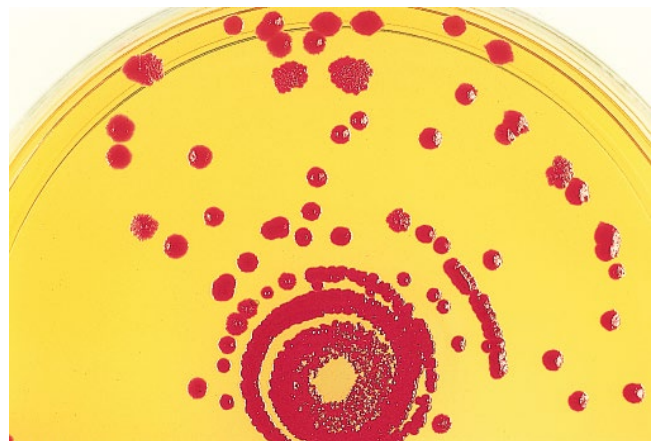




Figure 9-23 Iron uptake test. Mycobacteria able to convert ferric ammonium citrate to an iron oxide produce red-brown-rust colonies. This test is used to distinguish *M. chelonae*, which is usually negative (left), from *M. fortuitum* (right). Most rapid growers are positive, while slow growers are negative. The cultures should be incubated at 28°C for 2 weeks in tubes with the caps loose. They should be incubated for an additional 2 weeks before the test is considered negative.

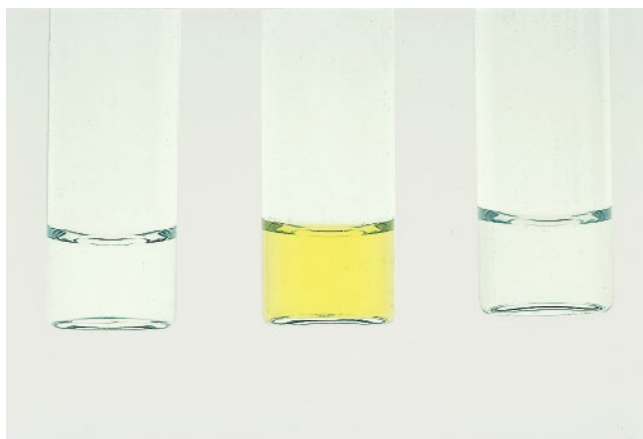


Figure 9-24 Niacin accumulation test. Certain mycobacteria, including *M. tuberculosis*, *M. simiae*, and some strains of *M. marinum* and *M. bovis* BCG, have a block in the metabolic pathway that converts free niacin to nicotinic acid. The niacin reacts with cyanogen bromide and a primary aromatic amine to produce a yellow color. *M. tuberculosis* (positive) is shown in the center, while an uninoculated control is shown on the left and *M. avium* (negative) is shown on the right.



A



B

Figure 9-25 Nitrate reduction test. The nitrate reduction assay is based on the ability of certain mycobacteria to reduce nitrate to nitrite due to the production of nitroreductase. It can be performed with chemical reagents or chemical strips. (A) In addition to *M. tuberculosis*, *M. kansasii*, *M. szulgai*, *M. smegmatis*, and *M. fortuitum* give positive results. The tube on the right contains *M. avium* (negative), the one in the center contains *M. tuberculosis* (positive), and that on the left is an uninoculated control. (B) A nitrate standard can be used to compare results. The three tubes on the left are considered negative and the three tubes on the right positive.

Figure 9-26 Pyrazinamidase test. Pyrazinamidase hydrolyzes pyrazinamide to pyrazinoic acid and ammonia. Pyrazinoic acid is detected in the presence of ferrous ammonium sulfate. *M. tuberculosis* gives positive results within 4 days (right), while *M. bovis* is negative even after 7 days (center). The tube on the left is an uninoculated control. The pyrazinamidase test is also useful for differentiating *M. kansasii* (negative) from *M. marinum* (positive in 4 days).

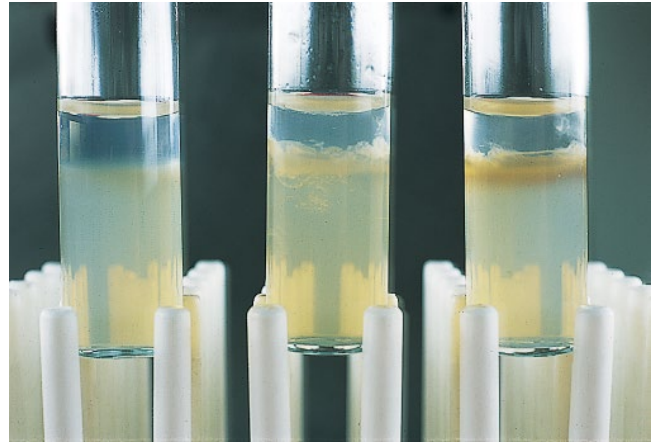


Figure 9-27 NaCl tolerance test. Most rapid growers, except *M. chelonae* and *M. mucogenicum*, and the slow-growing *M. triviale* can grow in the presence of 5% NaCl. Here, *M. gordonae* (negative) was inoculated in the left tube and *M. flavescens* (positive) was inoculated in the right tube.



Figure 9-28 Tellurite reduction test. Certain mycobacteria contain tellurite reductase, which reduces colorless potassium tellurite to a black metallic tellurium precipitate. This is illustrated by the negative reaction of *M. gordonae* (left). Organisms in the *M. avium*-*M. intracellulare* complex (right) reduce tellurite within 3 to 4 days, while other nonchromogens do not.





Figure 9-29 Tween 80 hydrolysis test. This assay helps to separate commonly saprophytic from potentially pathogenic, slow-growing scotochromogens and non-chromogens. *M. avium*-*M. intracellulare* complex, *M. xenopi*, and *M. scrofulaceum* are usually negative. Lipases produced by some mycobacteria hydrolyze Tween 80 (polyoxyethylene sorbitan monooleate) into oleic acid and polyoxyethylene sorbitol, resulting in a change in color of the medium. When bound by Tween 80, neutral red has an amber color at neutral pH as a result of the optical rotation of the transmitted light. Hydrolysis of Tween 80 releases the neutral red, which changes to a red color. Here, from left to right, are an uninoculated tube and tubes containing *M. avium*, *M. kansasii*, and *M. goodsonae*.



Figure 9-30 Urease test. Several methods are available for the detection of urease in mycobacteria. Hydrolysis of urea results in the production of ammonia and CO₂. This test is helpful in identifying scotochromogens and nonchromogens. The tube on the left was not inoculated. Pigmented strains of the *M. avium*-*M. intracellulare* complex should be urease negative (middle), while *M. scrofulaceum* produces urease (right).



Figure 9-31 BD BACTEC MGIT. BD BACTEC MGIT (mycobacterial growth indicator tubes) (BD Diagnostic Systems, Franklin Lakes, NJ) use fluorometric technology to expedite the reading of results. Positive tests emit an orange fluorescent glow at the base of the tube and at the meniscus that can be read using a Wood's lamp or other long-wave UV light source, or they can be incubated and read in the BD BACTEC 960 Instrumented Mycobacterial Growth System.

Introduction to *Enterobacterales*

10

The family *Enterobacteriaceae* was formerly in the order *Enterobacteriales*. However, the order has been reclassified as *Enterobacterales*, and the family *Enterobacteriaceae*, which was previously a single family in the order *Enterobacteriales*, has been split into seven families in the order *Enterobacterales*. Although a majority of the facultative anaerobic Gram-negative bacilli responsible for clinical infections are members of the family *Enterobacteriaceae*, *Yersinia* and *Serratia* have been moved to the family *Yersiniaceae* fam. nov.; *Proteus*, *Providencia*, and *Morganella* belong to *Morganellaceae* fam. nov.; *Hafnia* and *Edwardsiella* have been moved to the family *Hafniaceae* fam. nov.; and *Pantoea* and *Tatumella* belong to *Erwiniaceae* fam. nov. *Plesiomonas* is included in the order *Enterobacterales*; however, during the published 2016 reclassification (<http://www.bacterio.net/enterobacterales.html>), it was not assigned to a family and is considered family *incertae sedis*, since it has limited association with other members of the *Enterobacterales*.

The order *Enterobacterales* is composed of numerous genera of Gram-negative bacilli; however, 11 are responsible for the majority of clinical infections. These include *Citrobacter*, *Cronobacter*, *Enterobacter*, *Escherichia*, *Klebsiella*, *Plesiomonas*, *Proteus*, *Salmonella*, *Serratia*, *Shigella*, and *Yersinia*. Among these genera, the species *Escherichia coli*, *Klebsiella pneumoniae*, and *Proteus mirabilis* represent more than 90% of the *Enterobacterales* recovered in the clinical microbiology laboratory.

Some strains of *Enterobacterales* colonize the intestinal tract of humans. However, they can cause both

gastrointestinal and extraintestinal infections, especially in compromised hosts. Four genera are known to cause intestinal infections: *Escherichia*, *Salmonella*, *Shigella*, and *Yersinia*. Urinary and respiratory tract, wound, and bloodstream infections are the most common extraintestinal infections caused by *Citrobacter*, *Cronobacter*, *Enterobacter*, *Klebsiella*, *Plesiomonas*, and *Serratia*. Although it is rare, some can cause meningitis.

There has been a major increase in the number of genera and species within the family *Enterobacteriaceae* during the past 4 decades. The genera increased from 11 to 37 and from 26 to 148 species, biogroups, and unnamed enteric groups, although not all cause infections in humans. The taxonomic changes present a challenge to clinical microbiology laboratories, those caring for patients, and the commercial companies providing products for identification. Of the 29 species and subspecies of *Enterobacter*, several have been transferred to eight new genera not aligned with *Enterobacter*. For example, three well-known *Enterobacter* spp., *Enterobacter aerogenes*, *Enterobacter agglomerans*, and *Enterobacter sakazakii*, have now been transferred to three other genera, *Klebsiella*, *Pantoea*, and *Cronobacter*, respectively. *E. aerogenes*, a commonly isolated organism, is now classified as *Klebsiella aerogenes*. *Enterobacter agglomerans* has been reclassified as *Pantoea agglomerans*, and *Enterobacter sakazakii* has been moved to the genus *Cronobacter*, which now includes five species previously identified as *E. sakazakii*, and all cause infections in humans.

The taxonomic change from *E. aerogenes* to *K. aerogenes* may be detrimental to the treatment of patients, since *E. aerogenes* produces a chromosomally encoded AmpC, whereas *Klebsiella oxytoca* and *K. pneumoniae* do not, possibly resulting in treatment failures. Therefore, the impact on patient care should be considered before proposed taxonomic changes are implemented.

Prior to the recent approach for reclassification, the definition of the *Enterobacterales* included facultative anaerobic, Gram-negative bacilli that are cytochrome oxidase negative, non-spore forming, and glucose fermenters. This definition is no longer accurate, since *Plesiomonas*, recently transferred to the order *Enterobacterales*, is oxidase positive, and two species of *Serratia*, *Serratia marcescens* subsp. *sakuensis* and *Serratia ureilytica*, produce spores.

Microscopically, members of the order *Enterobacterales* vary from short bacilli measuring 2 to 3 μm in length to long, slender bacilli measuring 6 to 7 μm in length and are 0.5 to 2 μm in width. Some species are motile by means of uniformly distributed flagella, while others are nonmotile.

Although the *Enterobacterales* are considered facultative anaerobes, most grow well under aerobic conditions on routine laboratory media, including 5% sheep blood agar, as well as on differential media, such as MacConkey agar, or selective differential media, such as Hektoen enteric (HE) agar and xylose lysine deoxycholate (XLD) agar. In general, the *Enterobacterales* grow within 18 to 24 h at 35°C.

On blood agar, colonies of the *Enterobacterales* may be beta-hemolytic and are typically medium to large, glistening, and gray; however, some species have a characteristic morphology. For example, *Klebsiella* may produce mucoid colonies, *Proteus* colonies swarm, and *Yersinia* colonies are usually tiny and pinpoint. Additionally, some species, e.g., *S. marcescens*, *Serratia rubidaea*, *Cronobacter sakazakii*, and *Pantoea agglomerans*, produce a pigment.

Differential media are useful in differentiating the *Enterobacterales* from one another. MacConkey and eosin methylene blue agars are used to distinguish rapid lactose fermenters from delayed lactose fermenters or non-lactose fermenters. Other differential media, such as HE and XLD agars, further help to characterize the genera and species and differentiate some of the enteric pathogens from members of the normal intestinal microbiota. Most genera that are considered members of the normal enteric microbiota ferment salicin and produce a

salmon color on HE agar, whereas the enteric pathogens do not ferment salicin and form green colonies. Both HE and XLD agars contain ferric ammonium citrate, which permits the detection of H_2S -producing organisms such as *Salmonella* and *Proteus*. Selective media are helpful in differentiating a specific serotype within a species. For example, MacConkey agar with sorbitol can be used to distinguish *E. coli* O157:H7 from other serotypes of *E. coli*. *E. coli* O157:H7 produces colorless colonies on MacConkey agar with sorbitol because it is sorbitol negative, whereas most other serotypes of *E. coli* are sorbitol positive and appear as pink colonies. CHROMagar O157 is also a selective medium for *E. coli* O157:H7. Cefsulodin-irgasan-novobiocin (CIN) agar is a selective medium for *Yersinia*.

The *Enterobacterales* are biochemically active. They ferment glucose and other carbohydrates, often with the production of gas; they are oxidase negative, with the exception of *Plesiomonas*; they are catalase positive; and they reduce nitrate to nitrite. Fermentation of glucose results in the production of various end products, which can be determined by the methyl red and Voges-Proskauer tests.

Four commonly used methods to identify the *Enterobacterales* are the indole, methyl red, Voges-Proskauer, and citrate tests. As a group, they are usually referred to as the IMViC tests, and the various reactions are listed in Table 10-1. Other biochemical tests that assist in the identification of the *Enterobacterales* are those for phenylalanine, tryptophan, lysine, ornithine, arginine, urea, *o*-nitrophenyl- β -D-galactopyranoside (ONPG), gelatin, and 4-methylumbelliferyl- β -D-glucuronidase (MUG). The lysine decarboxylase, ornithine decarboxylase, and arginine dihydrolase tests are supplemental tests that are very helpful in identifying the *Enterobacterales*, especially the commonly isolated genera *Klebsiella*, *Enterobacter*, and *Serratia* (Table 10-2). Triple sugar iron (TSI) agar is also very helpful in identifying the *Enterobacterales* (Table 10-3).

Some of the *Enterobacterales* have the ability to utilize sodium malonate as the sole carbon source and ammonium dihydrogen as the sole nitrogen source. The reaction is similar to that described for citrate utilization. Table 10-4 lists the positive reactions for some of the commonly used tests for identification of *Enterobacterales*.

In general, one approach in the clinical microbiology laboratory is to use one or more screening tests to determine if additional testing with an identification system is necessary.

Table 10-1 IMViC lactose reactions of common *Enterobacterales*

Lactose fermentation	Organism(s) with reaction ^a				
	++00	00++	0+0+	++0+	0+00
Rapid	<i>Escherichia</i>	<i>Klebsiella</i>	<i>Citrobacter</i>		
	<i>Yersinia</i> V(+/0),+00	<i>Klebsiella oxytoca</i> (+0++)			
	<i>Plesiomonas shigelloides</i> ^b	<i>Raoultella</i> (V0++)			
		<i>Enterobacter</i> <i>Cronobacter</i>			
Late	<i>Escherichia</i>	<i>Hafnia alvei</i> (00+0)	<i>Citrobacter</i>	<i>Citrobacter</i>	<i>Shigella sonnei</i>
		<i>Klebsiella pneumoniae</i> subsp. <i>pneumoniae</i>	<i>Salmonella</i>		<i>Klebsiella pneumoniae</i> subsp. <i>ozaenae</i>
		<i>Enterobacter</i>			<i>Klebsiella pneumoniae</i> subsp. <i>rhinoscleromatis</i>
		<i>Serratia</i>			<i>Proteus penneri</i>
Negative	<i>Edwardsiella</i>		<i>Salmonella</i>	<i>Providencia</i>	<i>Shigella</i>
	<i>Proteus vulgaris</i>		<i>Salmonella enterica</i> serotype Typhi (0+00)		<i>Yersinia</i>
	<i>Morganella morganii</i>		<i>Proteus mirabilis</i> 0+V(+/0)V(+/0)		
	<i>Plesiomonas</i> ^b				

^aReactions are positive (+), negative (0), or variable (V) for indole, methyl red, Voges-Proskauer, and citrate.

^bThe only oxidase-positive organism in the order *Enterobacterales*.

Table 10-2 Decarboxylase-dihydrolase reactions of various members of the *Enterobacterales*

Organism	Reaction ^a for:		
	Lysine	Arginine	Ornithine
<i>Citrobacter koseri</i>	+	+	+
<i>Citrobacter freundii</i>	+	0	+
<i>Cronobacter sakazakii</i>	0	+	+
<i>Edwardsiella tarda</i>	+	0	+
<i>Enterobacter (Klebsiella) aerogenes</i>	+	0	+
<i>Enterobacter cloacae</i>	0	+	+
<i>Escherichia coli</i>	+	0	+
<i>Hafnia alvei</i>	+	0	+
<i>Klebsiella pneumoniae</i> subsp. other than <i>K. rhinoscleromatis</i>	+	0	0
<i>Klebsiella pneumoniae</i> subsp. <i>rhinoscleromatis</i>	0	0	0
<i>Morganella morganii</i>	0	0	+
<i>Pantoea agglomerans</i>	0	0	0
<i>Plesiomonas shigelloides</i>	+	+	+

(continued)

Table 10-2 (Continued)

Organism	Reaction ^a for:		
	Lysine	Arginine	Ornithine
<i>Pluralibacter (Enterobacter) gergoviae</i>	+	0	+
<i>Proteus mirabilis</i>	0	0	+
<i>Proteus vulgaris</i>	0	0	0
<i>Providencia</i>	0	0	0
<i>Salmonella</i> serovars other than <i>S. enterica</i> serovar Typhi	+	+	+
<i>Salmonella enterica</i> serotype Typhi	+	0	0
<i>Serratia</i> spp. other than <i>S. rubidaea</i>	+	0	+
<i>Serratia rubidaea</i>	+	0	0
<i>Shigella</i> spp. other than <i>S. sonnei</i>	0	0	0
<i>Shigella sonnei</i>	0	0	+
<i>Yersinia</i>	0	0	+

^a+, positive; 0, negative.

Table 10-3 TSI reactions^a of various *Enterobacteriales*

A/AG	A/AG H ₂ S ⁺	ALK/A	ALK/AG	ALK/AG H ₂ S ⁺	ALK/A H ₂ S ^w
<i>Citrobacter</i> spp.	<i>Citrobacter</i> spp.	<i>Escherichia coli</i>	<i>Escherichia coli</i>	<i>Citrobacter</i> spp.	<i>Salmonella enterica</i> serotype Typhi
<i>Cronobacter</i>	<i>Proteus vulgaris</i>	<i>Klebsiella pneumoniae</i> subsp. <i>rhinoscleromatis</i>	<i>Citrobacter</i> spp.	<i>Edwardsiella tarda</i>	
<i>Enterobacter</i>		<i>Morganella</i>	<i>Enterobacter</i> spp.	<i>Proteus mirabilis</i>	
<i>Escherichia coli</i>		<i>Proteus penneri</i>	<i>Hafnia</i>	<i>Salmonella</i> serovars other than <i>S. enterica</i> serovar Typhi and Paratyphi	
<i>Klebsiella</i> spp.		<i>Providencia</i> spp.	<i>Klebsiella</i> spp.		
<i>Pantoea</i>		<i>Serratia</i> spp.	<i>Proteus myxofaciens</i>		
<i>Pluralibacter gergoviae</i>		<i>Shigella</i> spp.	<i>Providencia alcalifaciens</i>		
<i>Plesiomonas shigelloides</i> ^b		<i>Yersinia</i> spp.	<i>Salmonella enterica</i> serovar Paratyphi		
<i>Yersinia</i> spp. ^c			<i>Serratia</i> spp.		
			<i>Yersinia kristensenii</i>		

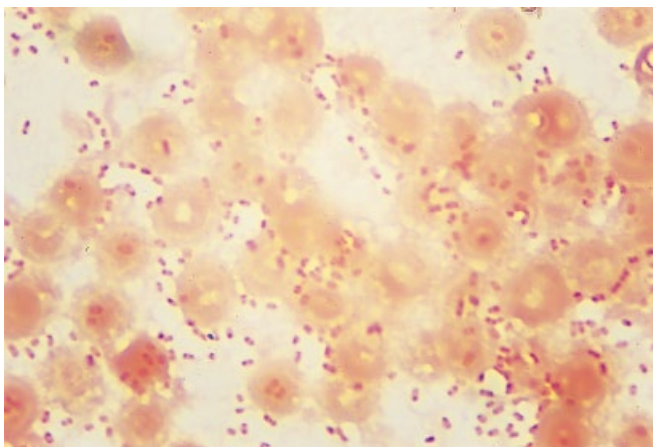
^aA, acid; ALK, alkaline; G, gas; +, positive; w, weak.

^b*Plesiomonas shigelloides* does not produce gas from glucose; the TSI reaction is acid/acid.

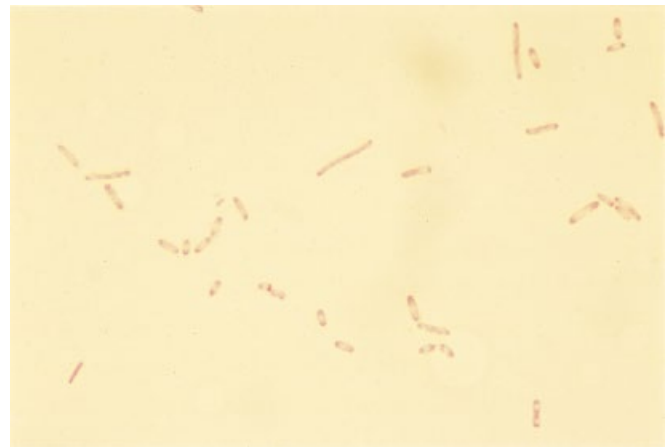
^c*Yersinia frederiksenii* can produce gas from glucose; *Yersinia enterocolitica* does not produce gas. Both ferment sucrose, resulting in an acid slant.

Table 10-4 Positive reactions of the *Enterobacterales* in commonly used tests

Phenylalanine deaminase	Urease	ONPG	Malonate	Gelatin hydrolysis
<i>Morganella</i>	<i>Citrobacter</i> ^{a,b}	<i>Citrobacter</i>	<i>Citrobacter koseri</i>	<i>Proteus</i>
<i>Proteus</i>	<i>Enterobacter cloacae</i> ^{a,b}	<i>Enterobacter</i>	<i>Enterobacter</i>	<i>Serratia</i>
<i>Providencia</i>	<i>Klebsiella</i> ^a	<i>Cronobacter</i>	<i>Klebsiella</i>	
	<i>Morganella</i> ^c	<i>Escherichia</i>	<i>Serratia rubidaea</i>	
	<i>Proteus</i> ^c	<i>Hafnia alvei</i>		
	<i>Providencia rettgeri</i> ^c	<i>Klebsiella</i>		
	<i>Yersinia</i> ^{a,b}	<i>Pantoea</i>		
		<i>Plesiomonas shigelloides</i>		
		<i>Raoultella</i>		
		<i>Serratia</i>		
		<i>Shigella sonnei</i>		
		<i>Yersinia</i>		

^aOvernight incubation.^bVariable (+/0).^cWithin 3 h.

A



B

Figure 10-1 Gram stain of *Enterobacterales*. Some species, such as *E. coli*, are short (2 to 3 μm long), plump, Gram-negative bacilli with bipolar staining (A), while others, such as *Proteus* spp., are long (6 to 7 μm long) with bipolar staining (B).

Figure 10-2 *Klebsiella pneumoniae* on blood agar. Colonies of *K. pneumoniae* are large (approximately 4 to 6 mm in diameter), gray, opaque, and somewhat mucoid.





Figure 10-3 *Proteus* spp. on blood agar. *Proteus* species exhibit a characteristic swarming on blood agar, causing a wave-like appearance across the agar plate. Individual colonies are not distinguishable due to the swarming effect resulting from this motility.



Figure 10-4 *Yersinia enterocolitica* on blood agar. Colonies of *Y. enterocolitica* are small (approximately 1 to 2 mm in diameter), gray, opaque, and pinpoint. Because of their small size, colonies of *Y. enterocolitica* do not resemble those of commonly isolated members of the *Enterobacterales*.

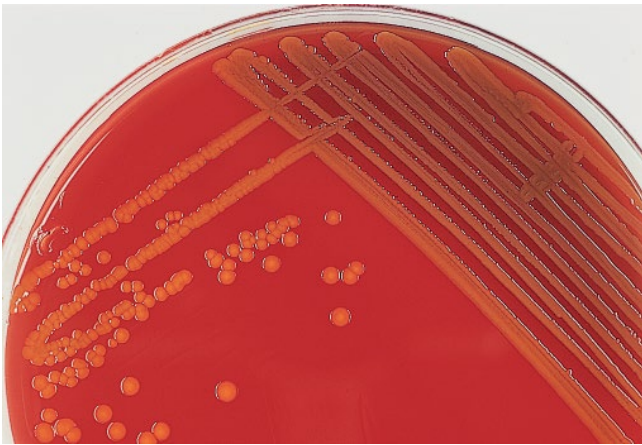


Figure 10-5 *Serratia* spp. on blood agar. *Serratia rubidaea* and some strains of *Serratia marcescens* produce a red to red-orange pigment, prodigiosin, that may appear throughout the colony or just at the center or margin.



Figure 10-6 *Escherichia coli* and *Klebsiella* spp. on MacConkey agar. Presumptive identification of *E. coli* and *Klebsiella* spp. can be made based on their characteristic morphology on MacConkey agar. *E. coli* colonies are dry, doughnut shaped, and dark pink, approximately 2 to 4 mm in diameter (left), while *Klebsiella* colonies are often mucoid, larger (4 to 6 mm), and dark to faint pink (right).



Figure 10-7 *Escherichia coli* and *Shigella* spp. on HE agar. HE agar is a selective and differential medium for the isolation and differentiation of enteric pathogens from members of the normal enteric microbiota. The medium contains bile salts; carbohydrates, including lactose, sucrose, and salicin; indicator dyes (bromthymol blue and acid fuchsin); sodium thio-sulfate; and ferric ammonium citrate for the detection of H_2S . The increased carbohydrate and peptone contents counteract the inhibitory effects of the bile salts and indicators. The carbohydrates distinguish the fermenters from the nonfermenters. Rapid fermenters, such as *E. coli*, appear as salmon pink to orange, surrounded by a zone of bile precipitate (left), while *Shigella* colonies are green (right).



Figure 10-8 H_2S -positive *Salmonella* colonies on HE agar. *Salmonella* and some *Proteus* strains form green to blue-green colonies with black centers when the colonies are H_2S positive.

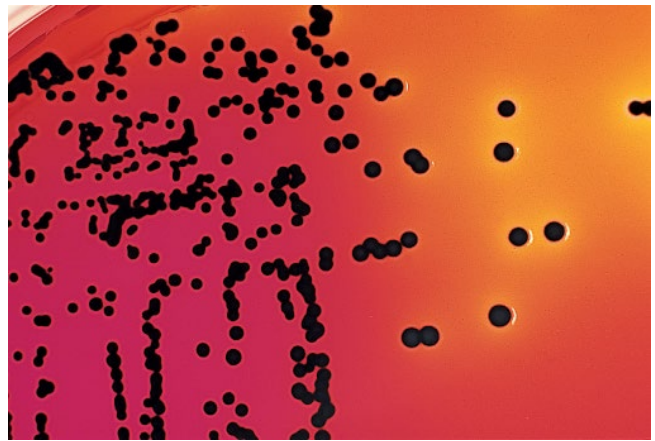


Figure 10-9 H_2S -positive *Salmonella* colonies on XLD agar. On XLD agar, *Salmonella* can be differentiated from members of the normal enteric microbiota by three reactions: xylose fermentation, lysine decarboxylation, and hydrogen sulfide production. On this medium, the production of hydrogen sulfide under alkaline conditions results in the formation of red colonies with black centers, characteristic of *Salmonella*, whereas under acidic conditions, this black precipitate is not formed.



Figure 10-10 *Escherichia coli* and *E. coli* O157:H7 on MacConkey agar with sorbitol. *E. coli* O157:H7 is sorbitol negative, and colonies appear colorless (left), whereas other strains of *E. coli* ferment sorbitol and appear as pink colonies (right).



Figure 10-11 *Yersinia enterocolitica* on CIN agar. CIN agar is a selective medium specifically used for the isolation of *Y. enterocolitica* from fecal specimens. This medium contains yeast extract, mannitol, and bile salts, with neutral red and crystal violet as pH indicators. Colonies are small (1 to 2 mm in diameter). *Y. enterocolitica* ferments mannitol, causing a drop in pH around the colony. The colony absorbs neutral red, which may appear as a red bull's-eye in the center of the colony. Most other bacteria, including other enteric bacteria that ferment mannitol, are inhibited on CIN agar.

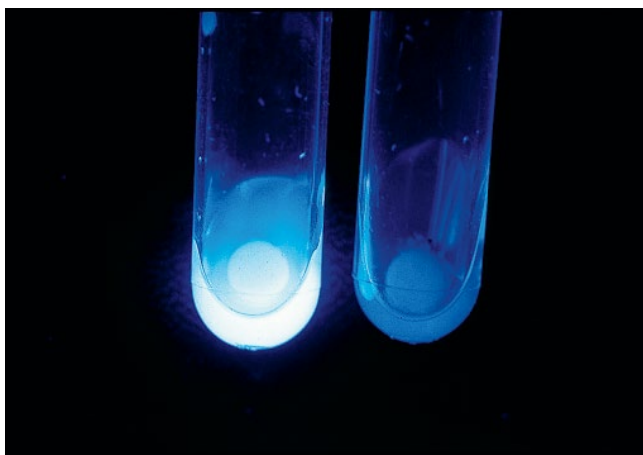


Figure 10-12 MUG test. In the presence of the enzyme β -glucuronidase, the substrate MUG releases 4-methylumbelliferone, a fluorescent compound that is easily detected by long-wave (360-nm) UV light (left tube). Since approximately 97% of all *E. coli* strains possess β -glucuronidase, the MUG test provides a rapid (30-min) method for the identification of this species. However, *E. coli* O157:H7 (right tube) rarely possesses β -glucuronidase.

Figure 10-13 BBL Crystal Enteric/Nonfermenter ID system. The BBL Crystal Enteric/Nonfermenter ID panel (BD Diagnostic Systems, Franklin Lakes, NJ) is a modified microplate consisting of 30 wells of organic and inorganic substrates for the identification of both the *Enterobacterales* and other Gram-negative bacilli. Following an 18- to 20-h incubation period, the wells are examined for color changes. The resulting pattern of reactions is converted into a 10-digit profile number that is used as the basis for identification. Shown here are *Klebsiella pneumoniae* (top), *Proteus mirabilis* (middle), and *Escherichia coli* (bottom).

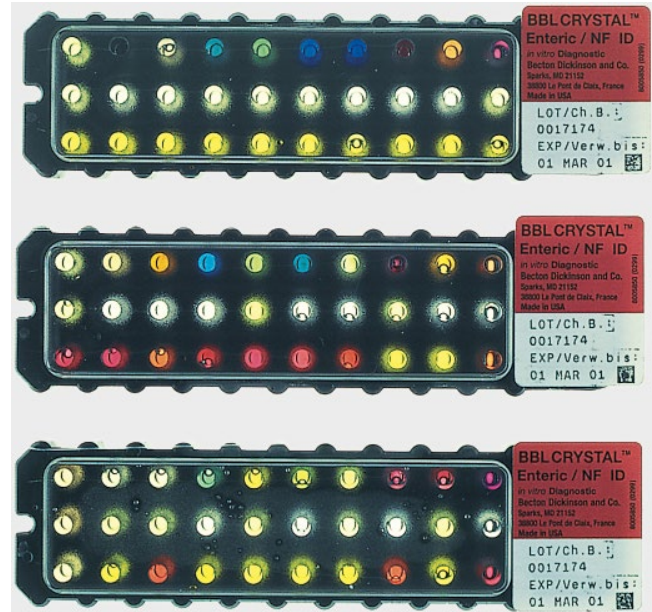


Figure 10-14 Micro-ID system. The Remel Micro-ID system (Thermo Fisher Scientific, Inc., Waltham, MA) is a self-contained unit with 15 biochemical tests for the rapid identification of the *Enterobacterales*. The system is based on the principle that bacteria contain preformed enzymes that can be detected in 4 h. Each reaction chamber contains a filter paper disk impregnated with a reagent that detects an enzyme or metabolic product. Following inoculation and incubation for 4 h, the reaction chambers are inspected and the findings are interpreted based on color changes. Shown here are *Klebsiella pneumoniae* (top), *Proteus mirabilis* (middle), and *Escherichia coli* (bottom).



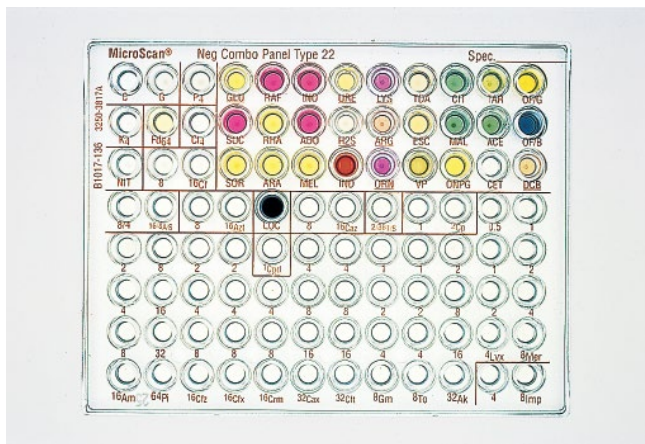


Figure 10-15 MicroScan Combo plate system. The MicroScan Combo plate system (Beckman Coulter, Brea, CA) utilizes modified conventional and chromogenic tests for the identification of fermentative and nonfermentative Gram-negative bacilli. Identification is based on detection of pH changes, substrate utilization, and growth in the presence of antimicrobial agents after 16 to 42 h of incubation at 35°C. Shown here is *Escherichia coli*.

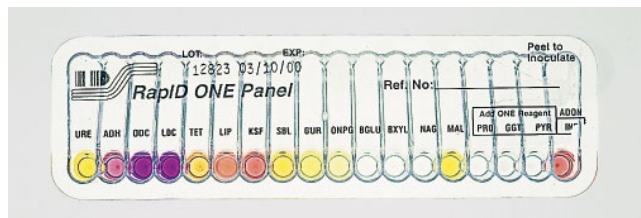


Figure 10-16 RapID oneE system. The RapID oneE system (Thermo Scientific, Inc., Waltham, MA) is a qualitative micromethod in which conventional and chromogenic substrates are used for the identification of medically important *Enterobacteriales* and other selected oxidase-negative, Gram-negative bacilli. A suspension of test organisms is used to rehydrate and initiate the test reactions. After 4 h at 35°C, each test cavity is examined for reactivity by noting the development of a color. The pattern of positive and negative results is used as the basis for identification of the isolate by comparison of the test results to reactivity patterns in a database. Shown here is *Escherichia coli*.



Figure 10-17 API 20E system. The API 20E system (bioMérieux, Inc., Durham, NC) is a self-contained system consisting of 20 microtubes of dehydrated substrates designed to measure standard biochemical tests for *Enterobacteriales*. Substrates are rehydrated by adding a bacterial suspension of a colony in 0.85% NaCl. For a rapid interpretation (4 h), the inoculum must equal a no. 1 McFarland turbidity standard. The substrates/tests included in the system are ONPG, arginine (ADH), lysine (LDC), ornithine (ODC), citrate (CIT), H₂S, urea (URE), tryptophan (TDA), indole (IND), Voges-Proskauer (VP), gelatin (GEL), glucose (GLU), mannitol (MAN), inositol (INO), sorbitol (SOR), rhamnose (RHA), saccharose (SAC), melibiose (MEL), amygdalin (AMY), and arabinose (ARA). Identification is made by adding the required reagents and visually interpreting the results. A numerical code is derived by dividing the tests into seven groups of three. The test results are converted to a seven-digit profile. The oxidase test, not performed on the API strip, is included with the results of AMY and ARA, thus providing the seventh digit. If any of the tests are positive, a score is assigned to each tube; the first test of each set is given a score of 1, the second test is assigned a score of 2, and the third test is assigned a score of 4. If the test is negative, it is given a 0. The total scores in a set can range from 0 to 7. Shown here is *Escherichia coli* with positive reactions (above the arrows) for ONPG, LDC, ODC, IND, GLU, MAN, SOR, RHA, MEL, and ARA. The oxidase test result, not shown, was negative. Therefore, the profile code number is 5144552.

Figure 10-18 Enterotube II identification system for *Enterobacterales*. The Enterotube II system (BD Diagnostic Systems, Franklin Lakes, NJ) is a compartmented plastic tube containing 12 different conventional media and an enclosed inoculating wire, resulting in the reactions of 15 standard biochemical tests using a single colony. The tests include glucose, gas production from glucose, lysine decarboxylase, ornithine decarboxylase, H_2S production, indole, adonitol, lactose, arabinose, sorbitol, Voges-Proskauer, dulcitol, phenylalanine deaminase, urea, and citrate. Identification is made by adding the required reagents and visually interpreting the results. The combination of color reactions, together with the computer coding system, allows identification of *Enterobacterales*. The system should be used only on oxidase-negative bacteria. The organism represented in this image is *Escherichia coli*. The positive reactions, indicated by the arrows, are glucose, gas production from glucose, lysine decarboxylase, ornithine decarboxylase, indole, lactose, arabinose, and sorbitol. The five-digit identifier is 36560.

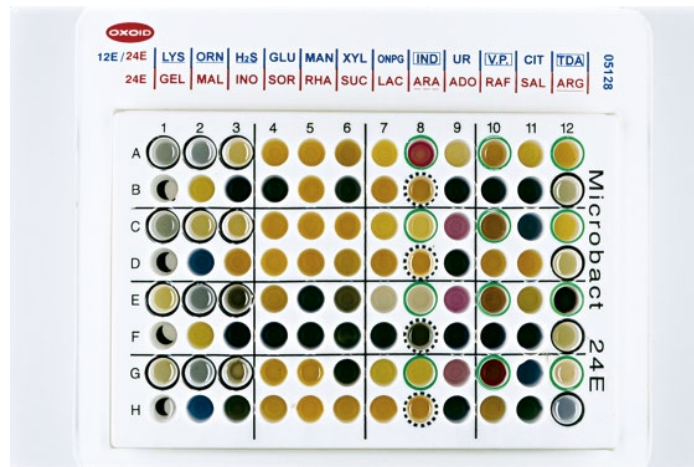
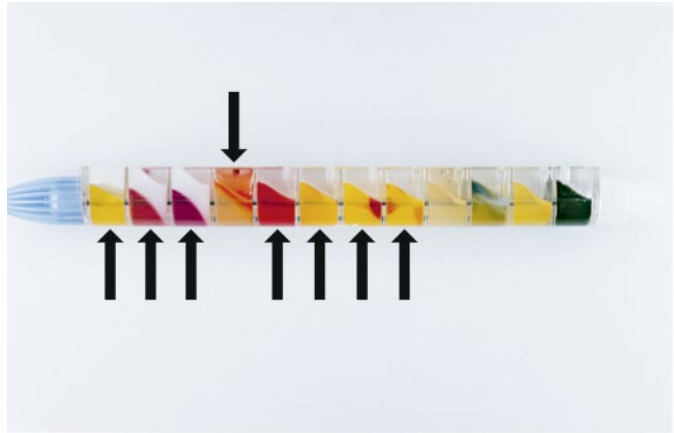


Figure 10-19 Microbact Gram-negative identification system. The Microbact 24E identification system (Thermo Fisher Scientific, Inc., Waltham, MA) consists of two separate strips, 12A (also referred to as 12E) and 12B, each containing 12 different biochemical substrates. Use of one strip alone will limit the ability to identify a wide range of Gram-negative bacilli. For example, the 12A strip will identify 15 genera within the order *Enterobacterales* that are oxidase negative, nitrate positive, and glucose fermenters. When the 12B strip is added, identification is expanded to include organisms that are oxidase positive, nitrate negative, and glucose nonfermenters. The substrates included in the Microbact 24E (with their abbreviations and expected positive reactions in parentheses), beginning with the top row, left to right, are lysine (LYS, blue-green), ornithine (ORN, blue), H_2S (black), glucose (GLU, yellow), mannitol (MAN, yellow), xylose (XYL, yellow), ONPG (yellow), indole (IND, pink-red), urease (URE, pink-red), Voges-Proskauer (VP, pink-red), citrate (CIT, blue), and tryptophan deaminase (TDA, cherry red). The bottom row includes gelatin (GEL, black), malonate (MAL, blue), inositol (INO, yellow), sorbitol (SOR, yellow), rhamnose (RHA, yellow), sucrose (SUC, yellow), lactose (LAC, yellow), arabinose (ARA, yellow), adonitol (ADO, yellow), raffinose (RAF, yellow), salicin (SAL, yellow), and arginine (ARG, green-blue at 24 h and blue at 48 h). Reagents are added to the IND, VP, and TDA wells. Additionally, nitrate reagents are added to the ONPG well once its reaction is read. It should be noted that the gelatin well should be read at 24 and 48 h for the *Enterobacterales* and only at 48 h for the other Gram-negative bacilli. The arginine color reaction is different at 24 and 48 h, as noted above. Identification is based on an eight-digit coding system similar to the API system described in the legend to Fig. 10-17. The organisms shown in this image, from top to bottom, are *Escherichia coli* (rows A and B), *Klebsiella pneumoniae* (rows C and D), *Proteus mirabilis* (rows E and F), and *Enterobacter cloacae* (rows G and H).



Figure 10-20 TSI agar. A TSI agar slant contains three carbohydrates, sucrose, lactose, and glucose, at a ratio of 10:10:1. For the detection of H_2S , sodium thiosulfate is present in the medium as the source of sulfur atoms. Two iron salts, ferrous sulfate and ferric ammonium citrate, react with the H_2S to form a black precipitate of ferrous sulfide. In the TSI tube, the agar in the top half forms a slant and thus is aerobic due to the exposure to oxygen, while the bottom (butt) is protected from air and, as a result, is considered anaerobic. Production of the gases CO_2 and H_2 is also detected by observing cracks or bubbles in the agar. The tubes should be inoculated with a single, well-isolated colony by using a long, straight wire. No change in the medium, indicated by an alkaline reaction in the slant and butt (ALK/ALK), means that the organism cannot ferment any of the sugars present, thereby excluding the *Enterobacteriales*. If glucose alone is fermented, the butt will be yellow due to the acid (A) production by the fermentation of glucose under anaerobic conditions; however, the slant will be alkaline (pink) due to the oxidative degradation of the peptones under aerobic conditions (ALK/A). Fermentation of glucose and lactose or of sucrose results in both an acidic slant and an acidic butt (A/A). As shown in this figure, members of the *Enterobacteriales* demonstrate a variety of reactions, and these six correspond to those shown in the headings of Table 10-3, beginning with an acid slant and an acid butt and gas in the very bottom of the tube (A/AG). Because they all ferment glucose, the butt will always be acidic (yellow). The last tube on the right shows a characteristic reaction for *Salmonella enterica* serovar Typhi because of the slight H_2S production. An alternative to the TSI system is Kligler iron agar (KIA), which does not contain sucrose. The advantage of the sucrose in TSI is that *Salmonella* and *Shigella* do not metabolize either lactose or sucrose. Thus, any acid-acid reaction on a TSI agar slant excludes *Salmonella* and *Shigella* spp. *Yersinia enterocolitica* ferments sucrose but not lactose, yielding results of A/A in TSI and ALK/A in KIA.

Escherichia, Shigella, and Salmonella

Escherichia coli is a member of the family *Enterobacteriaceae* and the enteric group *Escherichia-Shigella*. Although the genus *Escherichia* includes six species, *E. coli* is by far the most common, as well as being the bacterial species most frequently isolated in the clinical microbiology laboratory. It is normally found in the gastrointestinal tracts of humans and animals.

E. coli can be spread from person to person by the fecal-oral route and by contaminated food, unchlorinated water, raw milk, and improperly cooked beef. The source of contamination is usually bovine manure. *E. coli* causes both extraintestinal and gastrointestinal infections, including urinary tract infections, septicemia, health care-related pneumonia, and wound infections.

The most common extraintestinal *E. coli* infections are urinary tract infections (UTI) in young women of childbearing age. In addition, *E. coli* catheter-associated UTI are the most common health care-related infections. UTI can subsequently result in bloodstream infections. *E. coli* has now surpassed *Streptococcus agalactiae* as the leading cause of early-onset meningitis in neonates due to the adoption of screening and prophylaxis for group B streptococci in pregnant females.

The strains causing gastroenteritis or enteritis can be grouped according to clinical presentation: the most common are enterotoxigenic *E. coli* (ETEC), associated with chronic, persistent diarrhea and possibly a common cause of diarrhea in infants, young toddlers, and adults; enteropathogenic *E. coli* (EPEC), the cause of infantile diarrhea worldwide that results in fever,

vomiting, and watery diarrhea; enteroinvasive *E. coli* (EIEC), the *E. coli* type (pathovar) that is closely related to *Shigella* and that causes symptoms ranging from a mild form of diarrhea to a dysentery-like disease; enteroaggregative *E. coli* (EAEC), a cause of persistent, non-bloody watery diarrhea, which is implicated in traveler's diarrhea in the developed world; and Shiga toxin-producing *E. coli* (STEC) O157/enterohemorrhagic *E. coli* (EHEC) and non-O157, a cause of hemorrhagic colitis which is implicated in hemolytic-uremic syndrome (HUS).

All STEC isolates encode Shiga toxin 1 (Stx1) and/or Shiga toxin 2 (Stx2). STEC strains that cause hemorrhagic colitis or HUS are further designated as EHEC. Stx1 is associated with mild disease, and strains expressing Stx2 variants are more virulent, being linked to severe bloody diarrhea and increased incidence of HUS. STEC O157 is responsible for 30 to 80% of all STEC infections worldwide. Non-O157 STEC serotypes, which cause both mild and severe gastroenteritis, account for a majority of infections in some countries and are responsible for 20 to 50% of STEC infections in the United States. As a result, the Joint Commission has introduced standard QSA.04.06.01. This standard requires laboratories to perform tests that specifically detect Shiga toxin or the genes encoding the toxin in all patients with community-acquired diarrhea for the purpose of identifying non-O157 STEC. CDC recommends using a Shiga toxin assay (e.g., enzyme immunoassay) or molecular test. The guidelines were proposed to avoid missing STEC infection by testing on selective specimens, such as bloody stools.

Table 11-1 Characteristic reactions of *E. coli* and *Shigella* spp.^a

Characteristic	<i>E. coli</i>	Inactive <i>E. coli</i> biotypes ^b	<i>Shigella</i>
TSI	A/A G	Alk/A G	Alk/A
Indole	+	V	V
Methyl red	+	+	+
Voges-Proskauer	0	0	0
Citrate	0	0	0
Sorbitol	+	V	V
Lactose	+	0	0/+ ^c
Xylose	+	V	0
Lysine	+	V	0
Motility	+	0	0

^aA, acid; Alk, alkaline; G, gas; +, positive reaction (≥90% positive); V, variable reaction (11 to 89% positive); 0, negative reaction (≤10% positive).

^bNonmotile, anaerogenic biotypes.

^c*S. sonnei* is lactose positive.

Timing of specimen collection from patients with suspected gastrointestinal infections is based on the onset of illness. For example, fecal specimens should be collected within 4 days of disease onset, when organisms are usually present in their greatest numbers. Specimens should be processed within 2 h of collection or stored at 4°C until processed. A Gram stain of fecal specimens is not useful, since the Gram-negative bacilli cannot be distinguished from the normal Gram-negative intestinal microbiota.

Colonies of *E. coli* are gray, smooth, and often beta-hemolytic on blood agar. Hemolytic colonies isolated from urine specimens usually suggest more virulent strains. Most strains ferment lactose rapidly. Aerobic growth appears within 12 to 18 h at 35°C. The colonies are pink on MacConkey agar and are yellow to salmon on both Hektoen enteric (HE) and xylose lysine deoxycholate (XLD) agar plates. Sorbitol-containing MacConkey agar (SMAC) enhances the identification of *E. coli* O157. The inability of *E. coli* O157 to ferment sorbitol aids in differentiating this serogroup from strains normally found in the intestinal tract. In addition to SMAC, other media are available and have been shown to increase the sensitivity of cultures for STEC O157. These include CHROMagar O157 and cefixime- and tellurite-containing SMAC (CT-SMAC; BD Diagnostic Systems, Franklin Lakes, NJ). There is no selective medium for STEC non-O157 strains; therefore, testing for the presence of Shiga toxin is important.

Presumptive identification of *E. coli* should be based on Gram stain morphology, colony morphology on MacConkey agar, growth on triple sugar iron (TSI) agar slants, and IMViC (indole, methyl red, Voges-Proskauer, citrate) reactions (Table 11-1). In addition, *E. coli* strains can be differentiated from most other members of the *Enterobacteriales* because they are methylumbelliferyl-β-D-glucuronide positive. Most strains of *E. coli* are motile, with the exception of the nonmotile EIEC. This strain may also be a non-lactose fermenter or a late lactose fermenter and thus may be confused with *Shigella* spp. In addition, 5% of *E. coli* spp. are nonreactive/inactive or negative for many of the biochemical reactions routinely used to identify *E. coli* and, therefore, may also be confused with *Shigella*.

The genus *Shigella* is composed of four species, also considered serologic subgroups. These include *Shigella dysenteriae* (subgroup A), *Shigella flexneri* (subgroup B), *Shigella boydii* (subgroup C), and *Shigella sonnei* (subgroup D). Although *E. coli* (especially EIEC) and *Shigella* are similar, the difference between the two genera is the ability of *Shigella* to invade the intestinal epithelium. Biochemically, *Shigella* can be differentiated from *E. coli*, since *Shigella* strains are anaerogenic, nonmotile, and lysine decarboxylase negative and do not ferment lactose, with the exception of *S. sonnei*, which is a late lactose fermenter.

The common clinical symptoms of shigellosis are self-limiting and initially present as fever, abdominal cramps, and watery diarrhea. Within a few days, blood and mucus appear in the feces, suggesting that the organism has penetrated the intestinal mucosa. Large numbers of polymorphonuclear leukocytes can be observed during microscopic examination of feces. Overall, symptoms associated with shigellosis are mild, and some patients are asymptomatic. *S. dysenteriae* causes dysentery, the most severe form of shigellosis, which is related to the production of Shiga toxin. HUS is one of the most serious complications of these types of infections. Reactive arthritis, or Reiter's chronic syndrome, has been associated with *S. flexneri* infection. Humans are a natural reservoir, and the organism is spread by person-to-person contact or via contaminated water or food. As few as 10 bacteria can cause infection, compared to 10⁵ organisms for infection with *Salmonella* and some of the other enteric pathogens. For this reason, shigellosis is the most common infection among laboratory workers. *S. sonnei* is the most common *Shigella*

species causing shigellosis in developed countries, followed by *S. flexneri*.

MacConkey agar and either HE or XLD agar are recommended for optimal isolation of *Shigella*. Chromogenic agar is also helpful for identification, especially in combination with XLD agar. *Shigella* strains appear as colorless colonies on all four media because they do not ferment the carbohydrates contained in the media: lactose, salicin, sucrose, and xylose. *Shigella* spp. produce an alkaline (Alk) slant and an acid (A) butt, referred to as Alk/A and no gas in TSI agar slants. IMViC reactions can be similar to those of *E. coli*, i.e., indole positive, methyl red positive, Voges-Proskauer negative, and citrate negative, although *S. sonnei* is indole negative and 25 to 50% of the other *Shigella* spp. are indole positive (Table 11-1). Serologic testing is required for the grouping of *Shigella* isolates, because *S. flexneri* and *S. boydii* are biochemically indistinguishable by phenotypic testing. Also, identification by matrix-assisted laser desorption ionization-time of flight mass spectrometry is another option to differentiate these two species. In the diagnostic laboratory, serologic identification is routinely performed by a slide agglutination method with polyvalent antisera to somatic antigens. Isolates of *S. dysenteriae* should be sent to a reference laboratory for identification of the *S. dysenteriae* serotype.

The genus *Salmonella* is composed of two species, *Salmonella enterica* and *Salmonella bongori*, and there are more than 2,400 antigenically distinct members of these two species. *S. enterica* is subdivided into six subspecies, as determined by genetic similarity. Each subspecies is identified by a subspecies name or group number: *Salmonella enterica* subspecies *enterica* (group I), *S. enterica* subsp. *salamae* (group II), *S. enterica* subsp. *arizonae* (group IIIa), *S. enterica* subsp. *diarizonae* (group IIIb), *S. enterica* subsp. *houtenae* (group IV), and *S. enterica* subsp. *indica* (group VI). *S. enterica* subsp. *enterica* (group I) is most commonly isolated from humans and warm-blooded animals. Serotypes of clinical or epidemiologic importance within each subspecies may also be assigned a common name, such as *S. enterica* subsp. *enterica* serotype Typhi and *S. enterica* subsp. *enterica* serotype Enteritidis, which can be referred to as *S. Typhi* and *S. Enteritidis*.

Most infections with *Salmonella* are caused by contaminated food or water. Other reservoirs are humans and animals colonized with the organism. Pathogenicity

is based on the ability of the organism to invade and replicate within the gastric epithelial cells, which cannot be cleared by phagocytosis. Similar to infections with *Shigella* spp., intestinal infections with *Salmonella* spp. are usually self-limited in the otherwise healthy host; they cause diarrhea that can last as long as 1 week. *Salmonella* is also a cause of osteomyelitis in children with sickle cell disease. However, infection with *S. Typhi* causes serious sepsis, known as typhoid fever. The symptoms include fever and headache, often without diarrhea. The infection is more common in developing countries and is usually associated with foreign travel when it occurs in the United States. Similar infections are caused by *Salmonella enterica* serotype Paratyphi A, B, and C. Outbreaks of infections caused by *S. Enteritidis* are increasing in the United States and are usually associated with contaminated food, including raw or poorly cooked eggs. *S. Typhi* and *S. Paratyphi* express the Vi capsular antigen, which is unique among *Salmonella* serotypes. Approximately 5% of those infected with *S. Typhi* and *S. Paratyphi* become chronic asymptomatic carriers and shed the organism for up to 10 years. Carriage occurs in the gallbladder, and 90% of carriers have gallstones with biofilm formation on the surface. Of concern are *Salmonella* infections that are resistant to several antimicrobial agents. These are usually associated with *S. Typhi* and *S. Paratyphi* A.

Although MacConkey agar and either HE or XLD agar are recommended for the isolation of *Salmonella*, more highly selective media are available. These include xylose lysine Tergitol 4 (XLT4) and Rambach agars. Bismuth sulfite and brilliant green agars are the preferred media for isolation of *S. Typhi*. Suspicious colonies isolated from selective media should be subcultured onto TSI or Kligler iron agar slants. Typically, most *Salmonella* serotypes produce an alkaline reaction on the slant and an acidic reaction in the butt (Alk/A). They also generate gas in the tube, as well as large amounts of H₂S. Although *S. Typhi* produces Alk/A, it produces a very small amount of H₂S, which has been referred to as mustache-like, and no visible gas in TSI agar. The H₂S reaction for *S. Paratyphi* A is negative or weakly positive. Additional biochemical tests may be used to confirm the identification (Table 11-2).

Isolates of *Salmonella* spp. should be serotyped. These organisms may possess somatic (O), flagellar (H), and capsular (Vi) antigens. In the diagnostic

laboratory, serological identification is routinely performed by a slide agglutination method using polyvalent somatic antigen antisera as described for *Shigella*. Typing usually begins with O antigen antisera to confirm that the organism is *Salmonella*. If *S. Typhi* is suspected, the isolate should also be tested with the H group and then the Vi antigen. The Vi antigen is found predominantly in typhoidal strains. If only Vi is positive, the isolate should be heated in boiling water for 15 min, because the capsular antigen is heat labile. On retesting with O antiserum, the group D test should be positive. Since the Vi antigen is also expressed in some *Citrobacter* spp., the isolate should be identified to exclude *Citrobacter*. A laboratory may provide a preliminary report of *Salmonella* spp. based on biochemical reactions and serotyping. The isolate should then be referred to the health department for confirmation.

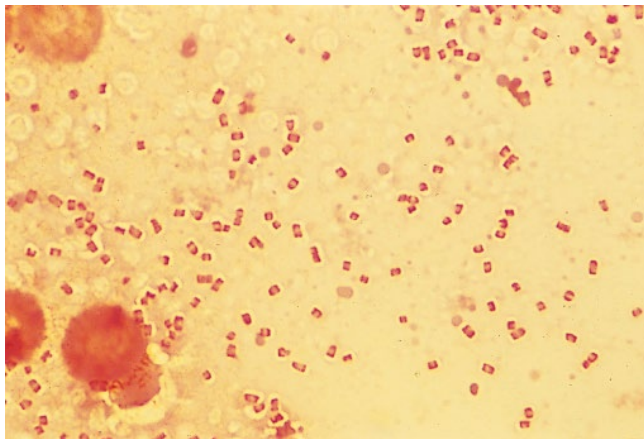


Figure 11-1 Gram stain of *Escherichia coli*. *E. coli* is a Gram-negative bacillus appearing as a short, plump, straight rod with bipolar staining, often resembling a safety pin. This morphology helps to distinguish *E. coli* from other *Enterobacterales*. Although bipolar staining occurs with the other *Enterobacterales*, they are usually longer bacilli.

Table 11-2 Characteristic reactions of *Salmonella* spp.^a

Characteristic	<i>Salmonella</i> spp. ^b	<i>Salmonella</i> serotype Typhi
TSI	Alk/A G	Alk/A
H ₂ S on TSI	+	Slight
Indole	0	0
Methyl red	+	+
Voges-Proskauer	0	0
Citrate	+	0
Ornithine	+	0
Arabinose	+	0
Dulcitol	+	0
Rhamnose	+	0

^aA, acid; Alk, alkaline; G, gas; +, positive reaction (≥90% positive); V, variable reaction (11 to 89% positive); 0, negative reaction (≤10% positive).

^bReactions for most commonly isolated *Salmonella* serotypes.



Figure 11-2 Colonies of *Escherichia coli* on MacConkey agar. On MacConkey agar, the colonies are pink, dry, and doughnut shaped and are surrounded by a dark pink area of precipitated bile salts. This is due to the rapid fermentation of lactose by this organism.

Figure 11-3 Colonies of *Escherichia coli* on HE agar. Colonies of *E. coli* on HE agar appear yellow-orange to salmon pink. This is due to the rapid fermentation of lactose by this organism.

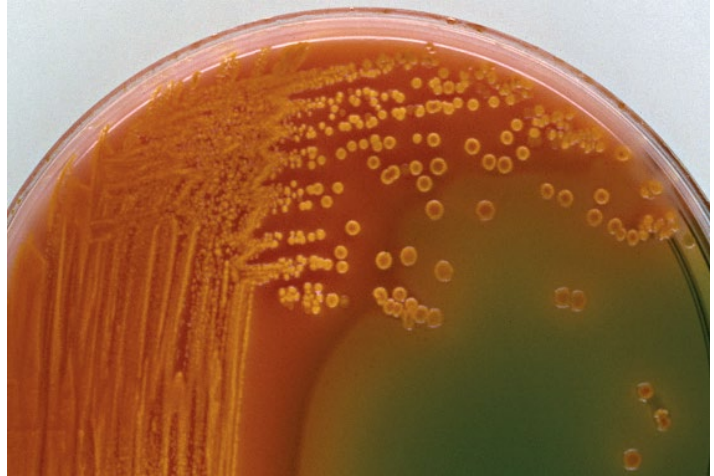


Figure 11-4 Colonies of *Escherichia coli* on CHROMagar O157. BBL CHROMagar O157 medium (BD Diagnostic Systems, Franklin Lakes, NJ), a selective medium for the isolation, differentiation, and presumptive identification of *E. coli* O157:H7, has been shown to increase the sensitivity of culture, thus allowing presumptive identification from the primary isolation plate and differentiation from other organisms. Due to the chromogenic substrates in the medium, colonies of *E. coli* O157:H7 produce a mauve color, as shown here, whereas *E. coli* non-O157:H7 and other *Enterobacterales* produce blue colonies. CHROMagar O157 contains cefixime, cefsulodin, and potassium tellurite, which reduces the number of other bacteria that grow on this medium.



Figure 11-5 *Escherichia coli* on a TSI agar slant. Colonies of *E. coli* on a TSI agar slant produce an acid slant and acid butt due to the rapid fermentation of glucose and lactose. This can result in copious gas production, causing the agar to split or be lifted from the bottom of the tube, as shown in this figure. A description of this test can be found in the legend to Fig. 10-20.





Figure 11-6 IMViC reactions of *Escherichia coli*. The four characteristic IMViC reactions of *E. coli* are indole positive, methyl red positive, Voges-Proskauer negative, and citrate negative (left to right). Descriptions of these tests can be found in chapter 41.

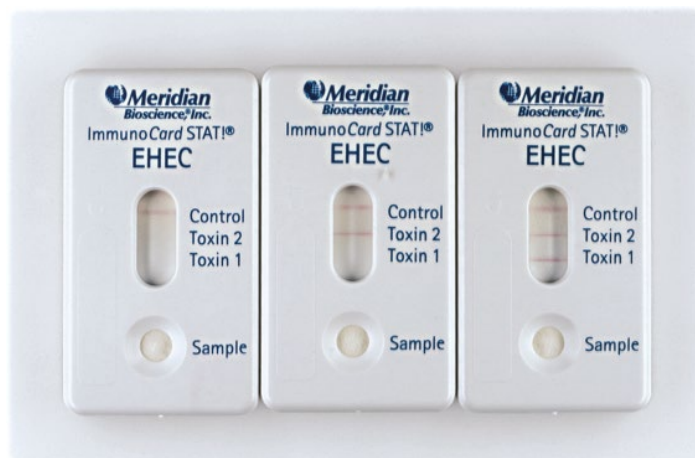


Figure 11-7 Toxin assay for the qualitative detection of Shiga toxins 1 and 2 produced by toxin-producing strains of *Escherichia coli*. The Meridian Bioscience ImmunoCard STAT! EHEC (Fisher Scientific, Waltham, MA) is based on the immunochromatographic lateral-flow principle. The test device contains immobilized monoclonal anti-Shiga toxin 1 and anti-Shiga toxin 2 antibodies labeled with red-colored gold particles. Each test has an internal control. The toxins in the sample form complexes with the gold-labeled antibody, which migrates through the pad until it encounters the binding zone in the test area. Due to the gold labeling, a distinct red line is formed, as shown here. The test on the left is negative for Shiga toxins 1 and 2, the center test is positive for toxin 2 only, and the test on the right is positive for both toxins 1 and 2.



Figure 11-8 Colonies of *Shigella* spp. and *Escherichia coli* on MacConkey agar. *Shigella* spp. are lactose negative and appear as colorless colonies (left), whereas *E. coli* is a rapid lactose fermenter and appears pink (right).

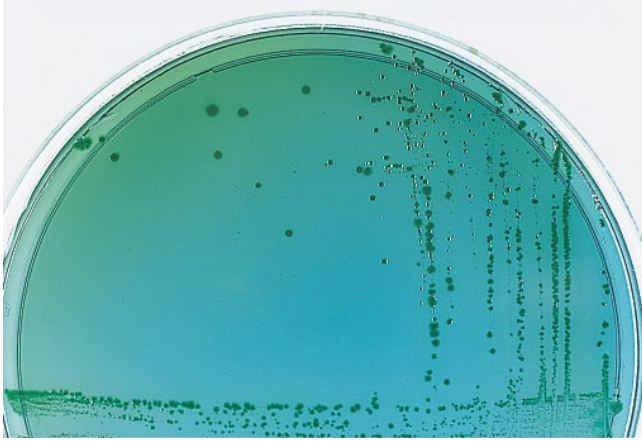
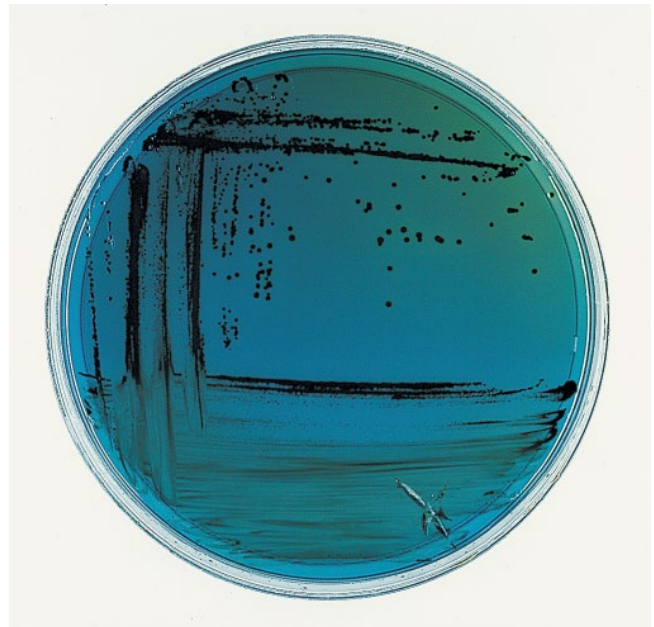


Figure 11-9 *Shigella* spp. on HE agar. *Shigella* spp. do not ferment lactose, salicin, or sucrose, the carbohydrates contained within HE agar; therefore, they appear as colorless colonies, as shown here.



Figure 11-10 *Shigella* spp. on a TSI agar slant. *Shigella* spp. ferment glucose but not lactose or sucrose present in the TSI agar slant; therefore, their result is Alk/A. They also do not produce H_2S or gas.

Figure 11-11 *Salmonella* spp. on HE agar. Although *Salmonella* spp. do not ferment the carbohydrates in HE agar, they do produce H_2S . The presence of ferric ammonium citrate in HE agar causes the colonies of *Salmonella* to appear black.



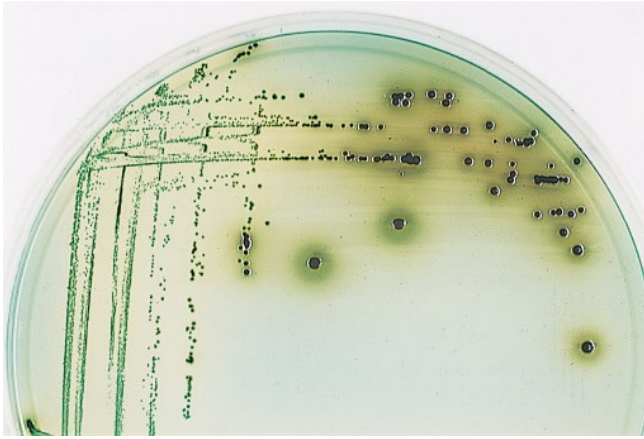


Figure 11-12 *Salmonella* serotype Typhi on bismuth sulfite agar. Bismuth sulfite agar contains ferrous sulfate, bismuth sulfite indicator, and brilliant green. Well-isolated colonies of *Salmonella* serotype Typhi are circular, jet black, and well defined. The black colony may vary from 1 to 4 mm in diameter, depending on the particular strain, length of incubation, and position of the colony on the agar. The larger colonies appear in the less dense areas on the agar plate. The typical discrete surface of a *Salmonella* serotype Typhi colony is black and is surrounded by a greenish or brownish black zone that appears several times the size of the colony, as shown here. By reflected light, this zone exhibits a distinctly characteristic metallic sheen.

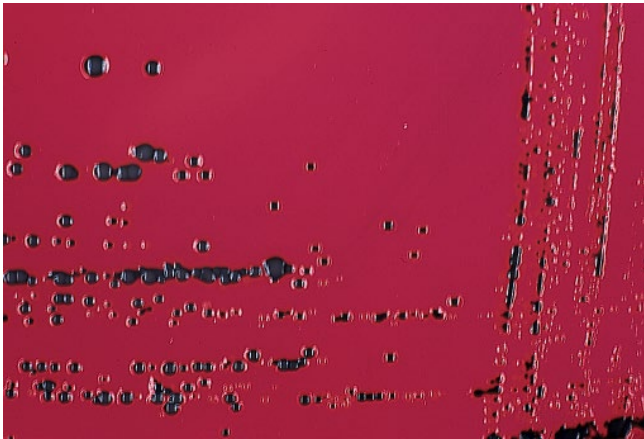


Figure 11-13 *Salmonella* on XLT4 agar. XLT4 agar was introduced in 1990 for the purpose of inhibiting bacterial overgrowth commonly associated with screening of fecal specimens for *Salmonella* spp. contaminated with enteric organisms. This medium is similar to XLD agar; however, the sodium deoxycholate is replaced with a 27% solution of Tergitol-4. This supplement inhibits the growth of non-*Salmonella* organisms. Typical H₂S-positive *Salmonella* colonies, other than *Salmonella* serotype Typhi, appear black after 18 to 24 h of incubation. Colonies of H₂S-negative *Salmonella* strains appear pinkish yellow. Other enteric organisms may appear red or yellow but should appear markedly inhibited, as shown here.



Figure 11-14 *Salmonella* on CHROMagar. BBL CHROMagar *Salmonella* (BD Diagnostic Systems) is a selective and differential medium for the isolation and presumptive identification of *Salmonella* spp. based on chromogenic substrates in the medium. *Salmonella* spp. appear as mauve (rose to purple) colonies, shown here, whereas other enteric organisms appear blue or colorless.



Figure 11-15 *Salmonella* on a TSI agar slant. Most *Salmonella* spp. ferment glucose and produce gas and large amounts of H_2S . Therefore, they cause the Alk/A G H_2S^+ reaction on a TSI agar slant.

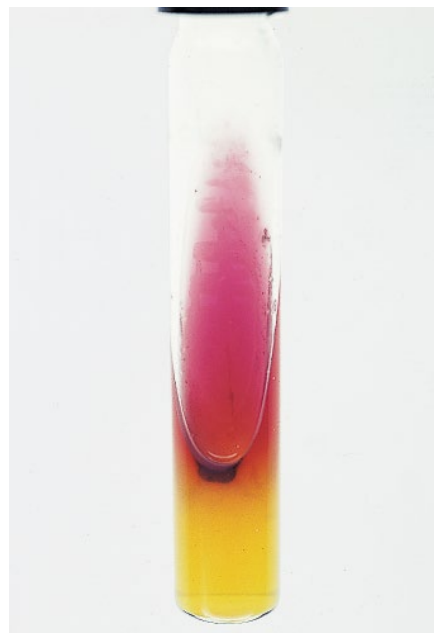


Figure 11-16 *Salmonella enterica* serotype Typhi on a TSI agar slant. Although *S. Typhi* ferments glucose like other *Salmonella* spp., it does not produce gas and produces only a small amount of H_2S , which has been referred to as mustache-like. The resulting reaction on a TSI agar slant is Alk/A slight H_2S .

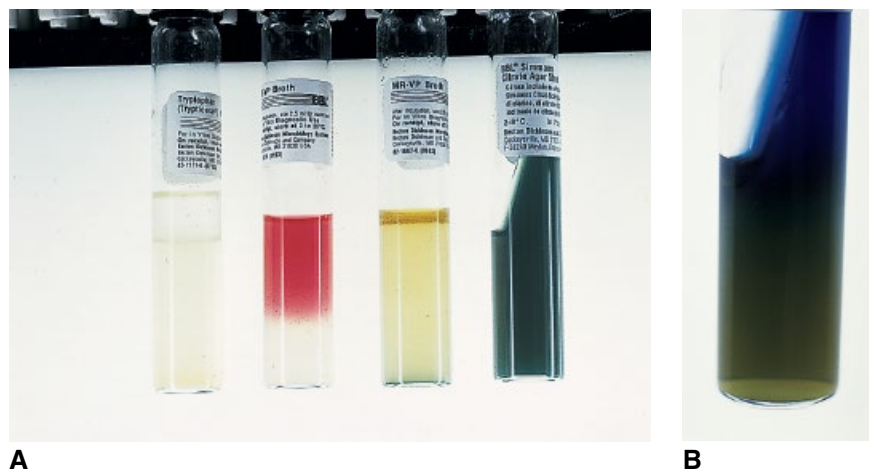


Figure 11-17 IMViC reactions of *Salmonella* serotype Typhi. The four characteristic reactions of *S. Typhi* are indole negative, methyl red positive, Voges-Proskauer negative, and citrate negative (A, left to right). Descriptions of these tests can be found in chapter 41. In comparison, most other commonly isolated *Salmonella* species have similar reactions for indole, methyl red, and Voges-Proskauer; however, they are citrate positive (B).



Figure 11-18 *Salmonella enterica* and *Salmonella* serotype Typhi in the API 20E system. Shown here are the reactions of *S. enterica* and *S. Typhi* on API 20E (bioMérieux, Inc., Durham, NC). *S. enterica* is in the top strip. The differentiating characteristics, indicated by the arrows, are arginine dihydrolase (ADH), ornithine decarboxylase (ODC), citrate (CIT), and H₂S. Most *Salmonella* serotypes are strongly positive for these reactions, whereas *S. Typhi* is negative for ADH, ODC, and CIT and weakly positive for H₂S. The carbohydrate reaction differences are shown in Table 11-2 and here.

Klebsiella, Enterobacter, Citrobacter, Cronobacter, Serratia, Plesiomonas, and Selected Other Enterobacterales

12

The Gram-negative bacilli discussed in this chapter were previously assigned to the order *Enterobacteriales* and the family *Enterobacteriaceae*. The order has been reclassified as *Enterobacterales*, and the single family *Enterobacteriaceae* has been split into seven families, of which four are included in this chapter. *Klebsiella*, *Enterobacter*, *Citrobacter*, *Cronobacter*, *Kosakonia*, *Lelliottia*, *Pluralibacter*, and *Raoultella* are all members of the family *Enterobacteriaceae*. *Edwardsiella* and *Hafnia* belong to the family *Hafniaceae* fam. nov. *Morganella*, *Proteus*, and *Providencia* belong to the family *Morganellaceae* fam. nov., *Pantoea* is in the family *Erwiniaceae* fam. nov., and *Serratia* is a member of the family *Yersiniaceae* fam. nov. *Plesiomonas* is a member of the order *Enterobacterales*, although it has not been placed in one of the seven families because of its limited association with other *Enterobacterales*. These genera have been isolated from clinical specimens and also have been recovered from the environment, plants, and animals. Although some are considered health care-related pathogens, the pathogenicity of others has not been established.

Klebsiella, *Enterobacter*, *Citrobacter*, *Cronobacter*, *Pantoea*, *Raoultella*, and *Serratia* cause a wide variety of infections, most frequently in hospitalized patients. These organisms are known to cause sepsis, infections of the respiratory tract and urinary tract, wound infections, and meningitis. They are part of the normal intestinal microbiota, and this is usually the source of the infection; however, they may be spread by person-to-person transmission, intravenous fluids, and medical devices.

Multidrug-resistant strains have caused outbreaks in hospitals, usually in locations with seriously ill patients, such as intensive care units. Over the last decade, there has been a sharp increase in *Klebsiella pneumoniae* isolates producing a carbapenemase referred to as KPC. In addition to being resistant to carbapenems, these isolates are often resistant to a variety of other antimicrobial agents. KPC, as well as other carbapenemases, can occur in other *Enterobacterales* along with other mechanisms that make these organisms carbapenem resistant. Therefore, *Enterobacterales* species that are resistant to carbapenems are referred to as carbapenem-resistant *Enterobacterales* (CRE). In addition to carbapenem resistance, some members of the *Enterobacterales* have also been reported to possess one or more Amp C β -lactamases. These include, but are not limited to, *Klebsiella (Enterobacter) aerogenes*, *Citrobacter*, *Enterobacter*, *Morganella* spp., *Proteus* spp., *Klebsiella oxytoca*, and *Serratia marcescens*.

The genus *Klebsiella* is composed of five species and three subspecies: *Klebsiella (Enterobacter) aerogenes*, *Klebsiella granulomatis*, *Klebsiella oxytoca*, *Klebsiella pneumoniae*, and *Klebsiella variicola*. Additionally, there are three subspecies of *K. pneumoniae*: *Klebsiella pneumoniae* subsp. *pneumoniae*, *K. pneumoniae* subsp. *ozaeanae*, and *K. pneumoniae* subsp. *rhinoscleromatis*. *K. pneumoniae* subsp. *pneumoniae* is the most frequently isolated from clinical specimens and causes pneumonia, urinary tract infections, and a variety of other infections, of which many are health care-associated infections. There is a hypervirulent strain of *K. pneumoniae* with a hypermucoviscous phenotype that is endemic in Taiwan

and Southeast Asia. If this phenotype is observed, a string test should be performed, and if it is positive, the isolate should be considered a hypervirulent strain.

The other two *K. pneumoniae* subspecies, *K. pneumoniae* subsp. *ozaenae* and *K. pneumoniae* subsp. *rhinoscleromatis*, are less frequently isolated and are associated with chronic infections. *K. pneumoniae* subsp. *ozaenae* causes atrophic rhinitis, and *K. pneumoniae* subsp. *rhinoscleromatis* causes rhinoscleroma, a chronic infectious process of the upper respiratory tract. *K. granulomatis* is a sexually transmitted pathogen, causing granuloma inguinale (also called donovanosis), which presents as chronic genital ulcers. Identification is based on the observation of Donovan bodies in biopsy specimens or tissue smears stained with Giemsa, Warthin-Starry, or Wright stains. *K. oxytoca* can cause antibiotic-associated hemorrhagic colitis due to the presence of a heat-labile cytotoxin, resulting in an abrupt onset of bloody diarrhea. However, unlike *Clostridioides (Clostridium) difficile*, it does not cause pseudomembranous colitis; it is self-limiting and resolves when the antibiotic is discontinued. *K. variicola* is associated with infections in blood and urine. Since *Klebsiella (Enterobacter) aerogenes* was recently transferred to the genus *Klebsiella*, it is discussed with the *Enterobacter* spp., to avoid confusion created by the taxonomic change, described in chapter 10.

There are eight species within the genus *Enterobacter*. Of these, seven have been recovered from clinical specimens. The two most common clinical isolates are *Enterobacter* (now classified as *Klebsiella*) *aerogenes* and *Enterobacter cloacae*. Species recently included in the genus *Enterobacter* are *Enterobacter asburiae*, *Enterobacter hormaechei*, *Enterobacter kobei*, *Enterobacter ludwigii*, and *Enterobacter nimipressuralis*. They are closely related to *E. cloacae*, have similar biochemical reactions, and may not be easily differentiated with commonly used identification methods. Therefore, it is recommended that they be reported as *E. cloacae* complex. Also included in this genus is *Enterobacter cancerogenus*, which causes a variety of infections in humans, including bacteremia, osteomyelitis, pneumonia, and urinary tract and wound infections. Health care-related *Enterobacter* colonization and infection are frequently associated with contaminated medical devices and instrumentation.

The genus *Citrobacter* is composed of 13 species. The three most common clinical isolates are *Citrobacter freundii*, *Citrobacter braakii*, and *Citrobacter koseri*. These organisms are opportunistic pathogens causing health

care-related infections. They include blood infections (which can be polymicrobial), gastrointestinal infections, urinary tract infections, and brain abscesses. Neonatal meningitis is exclusively associated with *C. koseri*.

Six species of the genus *Cronobacter* have been isolated from clinical specimens, five of which were previously classified as *Enterobacter sakazakii*. The most commonly isolated species is *Cronobacter sakazakii*. *C. sakazakii* is associated with neonatal meningitis and necrotizing enterocolitis. The source of infection has been traced to contaminated powdered milk formula. *C. sakazakii* has a yellow pigment, which is intensified when the organism is incubated at 25°C.

Seven *Serratia* species have been isolated from clinical specimens. *Serratia marcescens* is the one species that causes health care-related infections. Like other opportunistic organisms, it causes infections of the respiratory and urinary tracts, septicemia, and surgical wound infections. Other species, including *Serratia liquefaciens* and *Serratia rubidaea*, have been isolated from clinical infections, although their pathogenicity has not been confirmed. The genus *Raoultella* contains three species: *Raoultella ornithinolytica*, *Raoultella planticola*, and *Raoultella terrigena*. The latter two species share pathogenicity characteristics with *K. pneumoniae* and therefore are difficult to differentiate biochemically. However, *K. pneumoniae* grows at 44°C but not at 10°C, whereas *R. planticola* and *R. terrigena* grow at 10°C but not at 44°C.

The genus *Pantoea* is composed of more than 20 species, although eight have been isolated from clinical specimens. The most common isolate is *Pantoea* (formerly *Enterobacter*) *agglomerans*. This organism was responsible for a widespread outbreak of septicemia due to contaminated intravenous fluid. It has also caused osteomyelitis, soft tissue infections, and other infections due to administered contaminated fluids.

Klebsiella, *Enterobacter*, *Pantoea*, *Raoultella*, *Citrobacter*, and *Serratia* are Gram-negative bacilli that range from approximately 3 to 6 µm in length and are up to 1 µm in width. In general, these genera grow well on blood and MacConkey agars when incubated aerobically at 35°C for 18 to 24 h. Although encapsulated strains of *Klebsiella* are known to produce mucoid colonies, strains from the other genera can also have the same appearance. Some of the *Serratia* spp. are pigmented, including *Serratia rubidaea*, *Serratia plymuthica*, and some strains of *S. marcescens*. They produce a red pigment known as prodigiosin. Another characteristic that aids in the identification is the potato-like odor

Table 12-1 Key characteristics of some *Klebsiella* and *Raoultella* species and subspecies^a

Species	Indole	Ornithine	VP	Malonate	ONPG	Growth at 10°C	Growth at 44°C
<i>K. pneumoniae</i> subsp. <i>pneumoniae</i>	0	0	+	+	+	0	+
<i>K. pneumoniae</i> subsp. <i>ozaenae</i>	0	0	0	0	V	NA	NA
<i>K. pneumoniae</i> subsp. <i>rhinoscleromatis</i>	0	0	0	+	0	NA	NA
<i>K. oxytoca</i>	+	0	+	+	+	0	+
<i>R. ornithinolytica</i>	+	+	V	+	+	+	NA
<i>R. planticola</i>	V	0	+	+	+	+	0
<i>R. terrigena</i>	0	0	+	+	+	+	0

^aVP, Voges-Proskauer; ONPG, *o*-nitrophenyl-D-galactopyranoside; +, positive reaction (≥90% positive); V, variable reaction (11 to 89% positive); 0, negative reaction (≤10% positive); NA, not available.

produced by *Serratia odorifera*. *C. sakazakii* and *P. agglomerans* also produce a pigment that ranges from bright to pale yellow.

Most *Klebsiella*, *Enterobacter*, *Citrobacter*, *Cronobacter*, *Pantoea*, *Raoultella*, and *Serratia* spp. are identified using commercial kits, along with triple sugar iron (TSI) agar slants. If the identification of these genera is <90% for any species, the identification should be confirmed using conventional methods. These organisms, in the absence of pigment, may have similar colony morphologies. They may also be indistinguishable on TSI agar slants. Key biochemical tests that are helpful in the identification of *Klebsiella*, *Enterobacter*, *Citrobacter*, *Cronobacter*, *Pantoea*, *Raoultella*, *Serratia*, and other related genera are shown in Tables 12-1 through 12-4. The IMViC (indole, methyl red, Voges-Proskauer, and citrate) reactions of *Klebsiella* and *Enterobacter* are similar: negative for indole and methyl red and positive for Voges-Proskauer and citrate. However, *K. oxytoca* and *R. ornithinolytica* are indole positive (Table 12-1). Six species of *Citrobacter*, including *C. freundii*, may produce H₂S; however, some of the

more common clinical isolates are H₂S negative (Table 12-4). The late lactose-fermenting, H₂S-producing *Citrobacter* spp. resemble *Salmonella* on TSI agar slants and in IMViC reactions.

Proteus, *Providencia*, and *Morganella* are normally found in the human gastrointestinal tract and can cause urinary tract infections, although they have been isolated from other specimen types. Of the members of the tribe *Proteeae* isolated from clinical specimens, there are six species of *Proteus* (*Proteus mirabilis*, *Proteus vulgaris*, *Proteus penneri*, *Proteus hauseri*, *Proteus terrae*, and *Proteus cibarius*), five species of *Providencia* (*Providencia rettgeri*, *Providencia stuartii*, *Providencia alcalifaciens*, *Providencia rustigianii*, and *Providencia heimbachae*), and one species of *Morganella* (*Morganella morganii*). A majority of *Proteeae* infections appear to be community acquired, although *Providencia* spp. usually cause health care-related infections. *P. mirabilis* is a common cause of urinary tract infections, whereas *P. vulgaris* is isolated more often from wounds than from urine. Infections with *M. morganii* are frequently health care associated.

Table 12-2 Key characteristics of *Enterobacter*, *Pantoea*, and other related genera^a

Species	LDC	ADH	ODC	Malonate	Sorbitol	Urea hydrolysis ^b
<i>Cronobacter sakazakii</i>	0	+	+	0	0	0
<i>E. (Klebsiella) aerogenes</i>	+	0	+	+	+	0
<i>E. asburiae</i>	0	V	+	0	+	V
<i>E. cancerogenus</i>	0	+	+	+	0	0
<i>E. cloacae</i>	0	+	+	V	+	V
<i>E. hormaechei</i>	0	V	+	+	0	V
<i>E. kobei</i>	0	+	+	+	+	0
<i>Hafnia alvei</i>	+	0	+	+/V	0	0
<i>Hafnia paralvei</i>	+	0	V	0/V	0	0
<i>Kosakonia cowanii</i>	0	0	0	0	+	0
<i>Lelliottia amnigena</i>	0	V	+	+	+	0
<i>Pantoea agglomerans</i>	0	0	0	V	V	0
<i>Pluralibacter gergoviae</i>	+	0	+	+	0	+

^aLDC, lysine decarboxylase; ADH, arginine dihydrolase; ODC, ornithine decarboxylase; +, positive reaction (≥90% positive); V, variable reaction (11 to 89% positive); 0, negative reaction (≤10% positive); +/V, variable (majority are positive); 0/V, variable (majority are negative); NA, not available.

^bUsually >3 h.

Table 12-3 Differentiating characteristics of *Serratia* spp. isolated from clinical specimens^a

Species	Indole	LDC	ODC	Malonate	Sorbitol	Arabinose	Red pigment
<i>S. entomophila</i> ^b	0	0	0	0	0	0	0
<i>S. ficaria</i>	0	0	0	0	+	+	0
<i>S. fonticola</i>	0	+	+	+	+	+	0
<i>S. liquefaciens</i> group	0	+	+	0	+	+	0
<i>S. marcescens</i>	0	+	+	0	+	0	V
<i>S. marcescens</i> biogroup 1	0	V	V	0	+	0	0
<i>S. odorifera</i> biogroup 1	V	+	+	0	+	+	0
<i>S. odorifera</i> biogroup 2	V	+	0	0	+	+	0
<i>S. plymuthica</i>	0	0	0	0	V	+	+
<i>S. rubidaea</i>	0	V	0	+	0	+	+

^aLDC, lysine decarboxylase; ODC, ornithine decarboxylase; +, positive reaction (≥90% positive); V, variable reaction (11 to 89% positive); 0, negative reaction (≤10% positive).

^bTest reactions are from growth at 37°C; optimal growth is 30°C.

The *Proteaeae* grow well on routine laboratory media. Characteristic reactions of the *Proteaeae* are shown in Table 12-5. All species are lactose negative. *P. mirabilis* and *P. vulgaris* are easily recognized by their swarming growth on blood or chocolate agar media and their distinct odor, often resembling that of chocolate cake. They can be differentiated by an indole spot test and ampicillin susceptibility. *P. mirabilis* is indole negative and ampicillin susceptible, and *P. vulgaris* is indole positive and ampicillin resistant. All *Proteaeae* produce phenylalanine deaminase. *Proteus*, *Morganella*, and *P. rettgeri* produce urease. Commercially available systems accurately identify *Proteus*; however, *Providencia* can be misidentified. Also, rapid 2-h identification systems can misidentify *M. morganii* subsp. *morganii*.

There are three species of *Edwardsiella*, but *Edwardsiella tarda* is the only one associated with human disease. The organism, an infrequent cause of gastroenteritis and infections, has been linked to contact with fish and turtles. Serious wound infections have

been reported in immunocompetent individuals with aquatic exposure, whereas patients with liver disease may acquire serious systemic infections. *E. tarda* resembles *Salmonella* on many media, including MacConkey agar, xylose lysine deoxycholate agar, and TSI agar slants, because it is lactose negative and produces H₂S, but *E. tarda* is indole positive and citrate negative (Table 12-4).

The genus *Hafnia* has two species, *Hafnia alvei* and *Hafnia paralvei*, that have been recovered from clinical specimens. Both species have been found in the intestinal tracts of humans and are responsible for a wide variety of opportunistic infections, primarily gastrointestinal, respiratory, and urinary tract infections in immunosuppressed patients. Like other members of the *Enterobacteriales*, they grow well on routine laboratory media. Their biochemical characteristics are similar to those of *Enterobacter* and other related genera (Table 12-2).

The genus *Plesiomonas* has only a single species, *Plesiomonas shigelloides*. It was formerly a member of

Table 12-4 Key characteristics of *Citrobacter* spp. and *Edwardsiella tarda*^a

Species	Indole	Citrate	H ₂ S on TSI	LDC	ODC	Malonate
<i>C. amalonaticus</i>	+	+	0	0	+	0
<i>C. braakii</i>	V	V	V	0	+	0
<i>C. farmeri</i>	+	0	0	0	+	0
<i>C. freundii</i>	V	V	V	0	0	V
<i>C. gillenii</i>	0	V	V	0	0	+
<i>C. koseri</i>	+	+	0	0	+	+
<i>C. murliniae</i>	+	+	V	0	0	0
<i>C. sedlakii</i>	V	V	0	0	+	+
<i>C. werkmanii</i>	0	+	+	0	0	+
<i>C. youngae</i>	V	V	V	0	0	0
<i>E. tarda</i>	+	0	+	+	+	0

^aLDC, lysine decarboxylase; ODC, ornithine decarboxylase; +, positive reaction (≥90% positive); V, variable reaction (11 to 89% positive); 0, negative reaction (≤10% positive).

Table 12-5 Biochemical differentiation between members of the *Proteeae* and *Plesiomonas*^a

Species	Indole	H ₂ S	Urea	Ornithine	Maltose	Trehalose	Inositol
<i>Proteus</i>							
<i>P. hauseri</i>	+	V	+	0	+	0	0
<i>P. mirabilis</i>	0	+	+	+	0	+	0
<i>P. penneri</i>	0	V	+	0	0	V	0
<i>P. vulgaris</i>	+	+	+	0	+	V	0
<i>Providencia</i>							
<i>P. alcalifaciens</i>	+	0	0	0	+	0	0
<i>P. heimbachae</i>	0	0	0	0	V	0	V
<i>P. rettgeri</i>	+	0	+	0	0	0	+
<i>P. rustigianii</i>	+	0	0	0	0	0	0
<i>P. stuartii</i>	+	0	V	0	0	+	+
<i>Morganella</i>							
<i>M. morganii</i>	+	0	+	+	0	0	0
<i>Plesiomonas</i>							
<i>P. shigelloides</i>	+	0	0	+	+	+	+

^a+, positive reaction (≥90% positive); V, variable reaction (11 to 89% positive); 0, negative reaction (≤10% positive).

the family *Vibrionaceae*. However, because *Plesiomonas* is closer to the family *Enterobacteriaceae* than *Vibrionaceae* and because it contains the enterobacterial common antigen, it has been included in the family *Enterobacteriaceae*. However, it is oxidase positive, while all other members of the *Enterobacteriaceae* are oxidase negative.

Plesiomonas is found in surface waters and in soil. Its minimum growth temperature of 8°C and its inability to grow in a salty environment limit its distribution to freshwater and estuarine water. It infects cold-blooded animals. Humans are infected as a result of ingesting contaminated foods, especially raw fish, and handling infected cold-blooded animals. *P. shigelloides* is known to cause gastroenteritis, septicemia, and meningitis, although the last two infections are rare. Infections have been associated with travel to areas where the organism is endemic, mostly tropical and subtropical countries, and with residence in areas of endemic infection, such as Thailand, where the organism is found in approximately 25% of the population. Infections occur in the warmer months. Symptoms can range from short episodes of watery diarrhea to several days of dysentery-like diarrhea.

P. shigelloides is a straight, short, Gram-negative bacillus, measuring approximately 3.0 μm long by 1.0 μm wide. It is usually motile by means of tufts of two to five flagella at one end, although nonmotile strains do occur. The organism grows well on 5% sheep blood agar and most enteric media. Colonies are nonhemolytic, gray, shiny, and smooth, measuring approximately 1.5 mm in diameter after overnight incubation at 30 to 35°C, with optimal growth at 30°C. A selective medium,

inositol-bile salts-brilliant green agar, can be used if *P. shigelloides* is suspected; however, because of the low incidence of infection, it is not recommended for routine use. *P. shigelloides* is oxidase, indole, and catalase positive, reduces nitrate to nitrite, and ferments glucose along with other carbohydrates. It is positive for arginine, lysine, and ornithine and is DNase negative. Additional biochemical characteristics of *P. shigelloides* are presented in Table 12-5.

Three new genera, *Kosakonia*, *Lelliottia*, and *Pluralibacter*, have resulted because former *Enterobacter* spp. are better aligned with these three new genera. *Enterobacter amnigenus* biogroups 1 and 2 have been reclassified as *Lelliottia amnigena*. *L. amnigena* is a water organism that has been isolated from clinical specimens. Infections include cystitis, osteomyelitis, and sepsis following heart transplantation and blood transfusion. *Enterobacter cowanii* is now *Kosakonia cowanii*, and it has been isolated from blood, respiratory tract, urinary tract, and wound specimens. Biochemically, it resembles *Pantoea agglomerans*, since they are both lysine, ornithine, and arginine negative. *K. cowanii* can be differentiated from *P. agglomerans* based on dulcitol and sucrose. *K. cowanii* ferments dulcitol and sucrose, whereas *P. agglomerans* does not. *Enterobacter gergoviae* is now *Pluralibacter gergoviae*. *P. gergoviae* has been isolated from blood, respiratory tract, and urinary tract specimens. Biochemically it resembles *Enterobacter (Klebsiella) aerogenes* although *P. gergoviae* hydrolyzes urea and does not grow in KCN, while *Enterobacter (Klebsiella) aerogenes* is urea negative and KCN positive (Table 12-2).

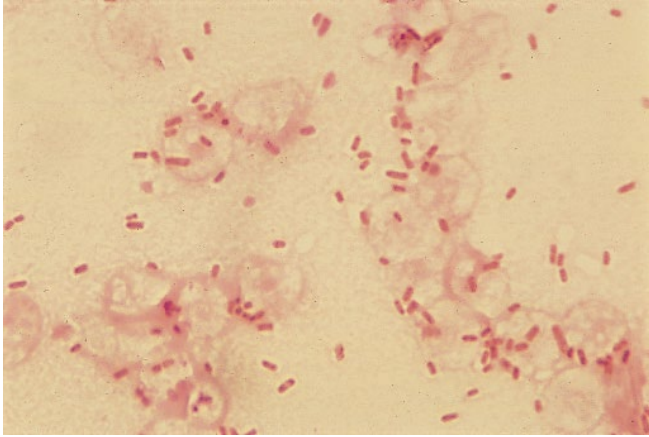


Figure 12-1 Gram stain of a sputum specimen with *Klebsiella*. This Gram stain from a sputum specimen containing *Klebsiella* demonstrates Gram-negative bacilli with bipolar staining, approximately 6 µm long and up to 1 µm wide. These bacilli are longer than the characteristic *Escherichia coli* cells shown in Fig. 11-1.



Figure 12-2 *Enterobacter* and *Klebsiella* on MacConkey agar. *Enterobacter* colonies are shown on the left of the MacConkey agar plate, and *Klebsiella* colonies are on the right. *Enterobacter* colonies are smaller (approximately 2 to 3 mm in diameter) than *Klebsiella* colonies (approximately 4 to 5 mm). Two distinguishing characteristics are lactose fermentation on the medium and the viscosity of the colonies. *Enterobacter* spp. are often late lactose fermenters, and thus the colonies can appear colorless to light pink, as shown here, whereas *Klebsiella* colonies are darker pink. Encapsulated strains of *Klebsiella* are also mucoid in appearance, a characteristic of some strains of this genus.



Figure 12-3 *Serratia marcescens* and *Citrobacter freundii* on MacConkey agar. Colonies of *S. marcescens* are shown on the left of this MacConkey agar plate, and *C. freundii* colonies are on the right. The *Serratia* colonies appear red, whereas the *Citrobacter* colonies are dark pink. The red color of the *Serratia* colonies is due to the pigment prodigiosin. *Citrobacter* closely resembles *E. coli* (see Fig. 11-2) in colony morphology (in both size and color).

Figure 12-4 *Klebsiella*, *Enterobacter*, *Serratia*, and *Citrobacter* on a TSI agar slant. Shown from left to right are the TSI reactions of *Klebsiella*, *Enterobacter*, *Serratia*, and *Citrobacter*. Large amounts of gas are produced by both *Klebsiella* and *Enterobacter*, causing the agar medium to be lifted from the bottom of the tubes. *Serratia* can be a slow lactose fermenter, resulting in an alkaline reaction in the slant, as seen here. Some species of *Citrobacter* produce H₂S, which can easily be detected in the TSI slant.



Figure 12-5 Arginine, lysine, and ornithine decarboxylase reactions of *Enterobacter* and related genera. Shown here are three sets of reactions for arginine dihydrolase (ADH), lysine decarboxylase (LDC), and ornithine decarboxylase (ODC). The top three reactions are negative, suggestive of *Pantoea agglomerans*. In the center set, both ADH and ODC are positive and LDC is negative. These are characteristic reactions for *Enterobacter cloacae* and *Cronobacter sakazakii*. In the bottom set, both LDC and ODC are positive, suggesting either *Enterobacter (Klebsiella) aerogenes* or *Pluralibacter gergoviae*.



Figure 12-6 IMViC reactions of *Klebsiella*, *Enterobacter*, and *Serratia*. *Klebsiella*, *Enterobacter*, and *Serratia* have similar IMViC reactions; the indole and methyl red reactions (the two tubes on the left) are negative, and the Voges-Proskauer and citrate reactions (the two tubes on the right) are positive.





Figure 12-7 IMViC reactions of *Citrobacter*. The IMViC reactions of *Citrobacter* differ from those of *Klebsiella*, *Enterobacter*, and *Serratia* (Fig. 12-6). As shown here, the indole and Voges-Proskauer reactions (tubes 1 and 3 from the left) are negative and the methyl red and citrate reactions (tubes 2 and 4 from the left) are positive, characteristic findings for *Citrobacter*.



Figure 12-8 Colonies of *Cronobacter sakazakii* grown on nutrient agar. *C. sakazakii* is easily distinguished from most *Enterobacter* spp. by its characteristic bright yellow pigment.



Figure 12-9 *Enterobacter (Klebsiella) aerogenes*, *Enterobacter cloacae*, and *Enterobacter cancerogenus* in the API 20E system. The API 20E strips (bioMérieux, Inc., Durham, NC) were inoculated with *E. cloacae* (top strip), *E. aerogenes* (middle strip), and *E. cancerogenus* (bottom strip). *E. (K.) aerogenes* and *E. cloacae* are the most common *Enterobacter* spp. isolated in the diagnostic laboratory. Although the reactions of these two species are similar, the distinguishing biochemicals, indicated by the arrows, are arginine dihydrolase (ADH), lysine decarboxylase (LDC), and inositol (INO). *E. cloacae* (top) is ADH positive, LDC negative, and INO negative, whereas *E. (K.) aerogenes* (middle) is ADH negative, LDC positive, and INO positive. *E. cloacae* and *E. cancerogenus* are also very similar, with the exception of the sucrose (SAC) and melibiose (MEL) reactions, both of which are positive for *E. cloacae* and negative for *E. cancerogenus*.



Figure 12-10 *Citrobacter freundii* and *Citrobacter amalonaticus* in the API 20E system. *C. freundii* was inoculated in the top strip and *C. amalonaticus* was inoculated in the bottom strip. The differences between the two species, indicated by the arrows, are the reactions for ornithine decarboxylase (ODC), H₂S, indole (IND), and melibiose (MEL). *C. freundii* produces H₂S and is negative for the other three tests, whereas *C. amalonaticus* is negative for H₂S and positive for the other three.

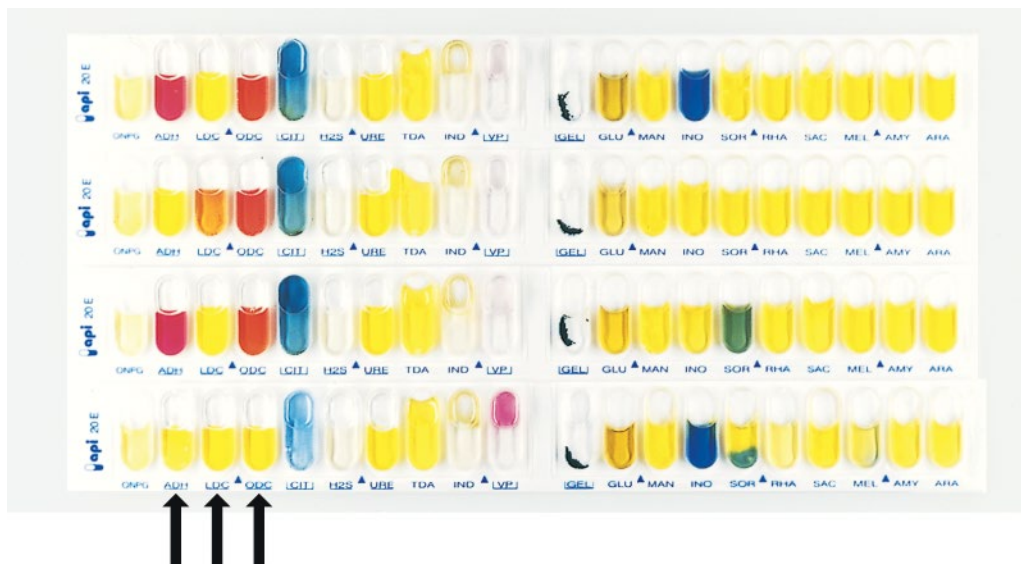


Figure 12-11 *Enterobacter cloacae*, *Enterobacter (Klebsiella) aerogenes*, *Cronobacter sakazakii*, and *Pantoea agglomerans* in the API 20E system. From top to bottom, the organisms are *E. cloacae*, *E. (K.) aerogenes*, *E. sakazakii*, and *P. agglomerans*. The major differentiating reactions among these four organisms, indicated by the arrows, are arginine dihydrolase (ADH), lysine decarboxylase (LDC), and ornithine decarboxylase (ODC). These reactions are listed in Table 12-2.

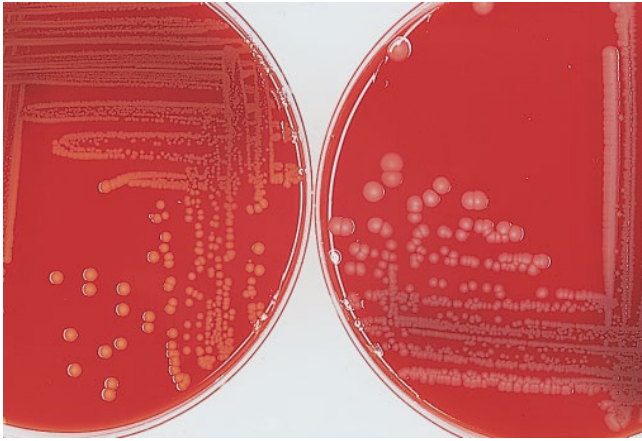


Figure 12-12 Colonies of *Cronobacter sakazakii* and *Enterobacter cloacae* on blood agar. Yellow colonies produced by *C. sakazakii* are shown on the blood agar plate on the left, in comparison to the gray colonies of *E. cloacae* on the right.

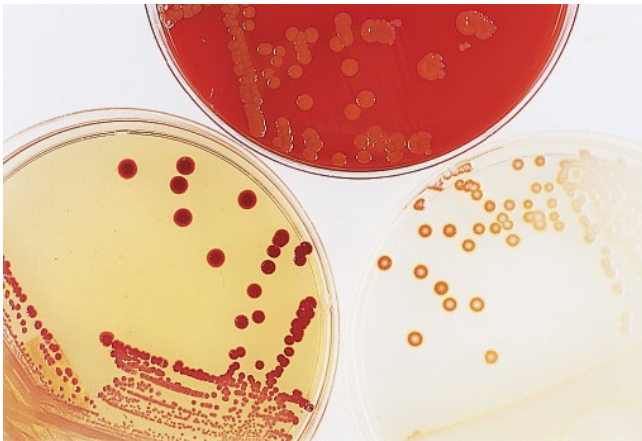


Figure 12-13 Colonies of *Serratia rubidaea* on blood, MacConkey, and nutrient agars. The red pigment produced by *S. rubidaea* is easily detected when the organism is grown on nutrient agar (bottom left) or Mueller-Hinton agar, in contrast to growth on blood agar (top) and MacConkey agar (bottom right).



Figure 12-14 Colonies of *Klebsiella pneumoniae* subsp. *ozaenae* on blood agar. Colonies of *K. pneumoniae* subsp. *ozaenae* on blood agar after a 24-h incubation at 35°C are 2 to 4 mm in diameter, gray, and mucoid. The organism contains a large polysaccharide capsule, which gives rise to mucoid colonies.

Figure 12-15 Colonies of *Klebsiella pneumoniae* subsp. *ozaenae* on MacConkey agar. Colonies of *K. pneumoniae* subsp. *ozaenae* on MacConkey agar after a 48-h incubation at 35°C are 5 to 6 mm in diameter, pink, and mucoid.

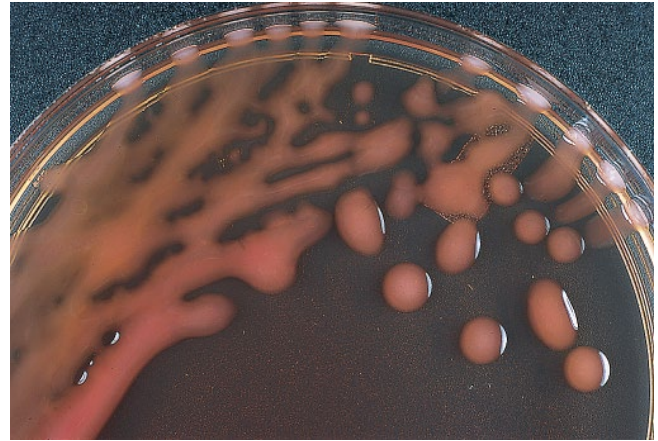


Figure 12-16 *Klebsiella*, *Enterobacter*, *Serratia*, and *Citrobacter* identified by the Enterotube II identification system. The Enterotube II system (BD Diagnostic Systems, Franklin Lakes, NJ) is described in the legend to Fig. 10-18. The organisms in this figure, from top to bottom, are *Klebsiella*, *Enterobacter*, *Serratia*, and *Citrobacter*. The reactions for lysine decarboxylase (LDC), ornithine decarboxylase (ODC), H₂S, adonitol (ADON), lactose (LAC), arabinose (ARAB), Voges-Proskauer (VP), and urease (URE) help to differentiate the four genera, whereas the reactions for glucose (GLU), indole (IND), sorbitol (SOR), dulcitol (DUL), phenylalanine deaminase (PAD), and citrate (CIT) are the same, as indicated below.



Organism	GLU	Gas	LDC	ODC	H ₂ S	IND	ADON	LAC	ARAB	SOR	VP	DUL	PAD	URE	CIT
<i>Klebsiella</i>	+	+	+	0	0	0	+	+	+	+	+	0	0	+	+
<i>Enterobacter</i>	+	+	0	+	0	0	0	0	+	+	+	0	0	0	+
<i>Serratia</i>	+	0	+	+	0	0	0	+	0	+	+	0	0	0	+
<i>Citrobacter</i>	+	+	0	0	+	0	0	+	+	+	0	0	0	0	+
			↑	↑	↑		↑	↑	↑		↑				↑

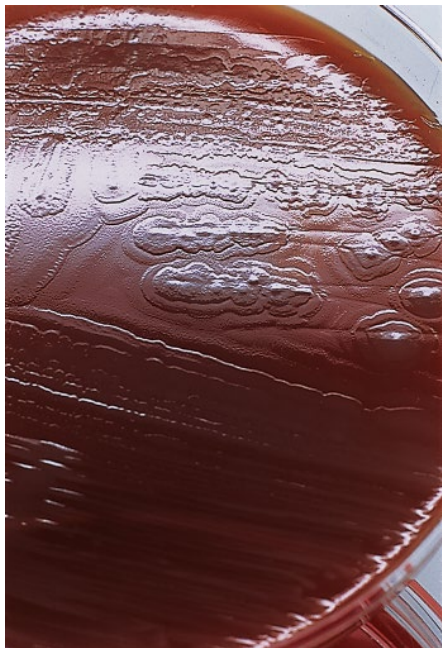


Figure 12-17 *Proteus mirabilis* on blood agar. As a result of motility, *Proteus* spp. swarm on blood and chocolate agars. Swarming results in the production of a thin film of growth on the agar surface. The organism was inoculated across the center of the blood agar, causing the growth to occur in waves, spreading across the entire plate. Colonies can produce a chocolate cake-like odor.



Figure 12-18 *Proteus vulgaris* and *Proteus mirabilis* on a TSI agar slant. The TSI agar slant on the left, acid/acid and H₂S positive, shows the expected reaction for *P. vulgaris*, and the alkaline/acid and H₂S positive result (right) is the expected reaction for *P. mirabilis*. *P. vulgaris* ferments glucose and sucrose, resulting in an acid slant and acid butt because TSI agar contains both carbohydrates. However, *P. mirabilis* ferments glucose but not sucrose, resulting in an alkaline slant and an acid butt. TSI alone cannot be used to identify these two species or any of the *Enterobacteriales*, since many of these organisms have the same reactions as those in this figure. For example, some *Citrobacter* spp. have the same TSI reactions as *P. vulgaris*. Also, the TSI reactions for *P. mirabilis*, *Salmonella* spp., and *Edwardsiella tarda* are the same. Refer to Fig. 10-20 for a complete description of TSI agar slants.



Figure 12-19 *Proteus vulgaris*, *Proteus mirabilis*, and *Morganella morganii* in the API 20E system. *Proteus* spp. and *M. morganii* are closely related and have many similar biochemical reactions. The similarities and differences of *P. vulgaris* (top), *P. mirabilis* (middle) and *M. morganii* (bottom) are shown here. All three species are urea (URE) and tryptophan deaminase (TDA) positive, characteristic reactions of these organisms. *M. morganii* is H₂S negative, while the *Proteus* spp. are positive. *P. mirabilis* is citrate (CIT) positive and indole (IND) negative, differentiating it from the other two species. The differentiating reactions are indicated by the arrows. The reactions of *P. vulgaris*, *P. mirabilis*, and *M. morganii* are as follows.

Organism	ONPG	ADC	LDC	ODC	CIT	H ₂ S	URE	TDA	IND	VP	GEL	GLU	MAN	INO	SOR	RHA	SAC	MEL	AMY	ARA
<i>P. vulgaris</i>	0	0	0	0	0	+	+	+	+	0	+	+	0	0	0	0	+	0	0	0
<i>P. mirabilis</i>	0	0	0	+	+	+	+	+	0	0	0	+	0	0	0	0	0	0	0	0
<i>M. morganii</i> subsp. <i>morganii</i>	0	0	0	+	0	0	+	+	+	0	0	+	0	0	0	0	0	0	0	0
				↑	↑	↑			↑	↑							↑			

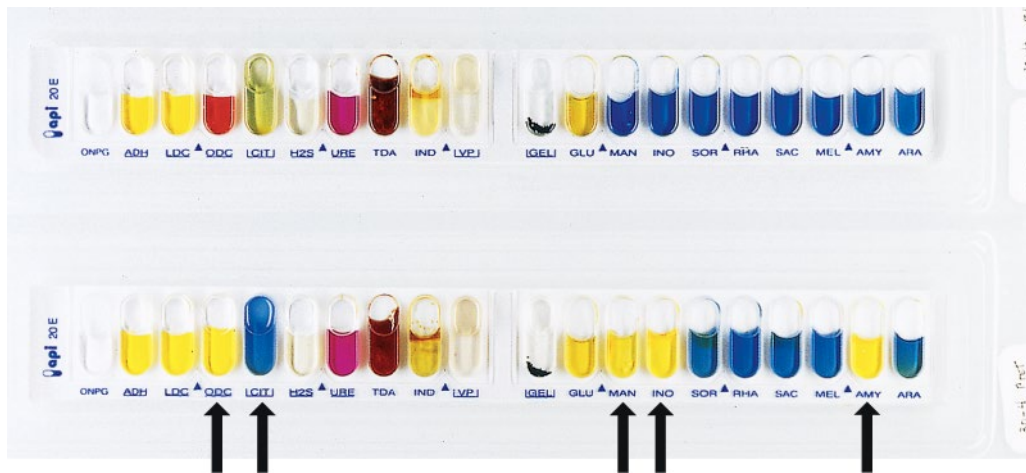


Figure 12-20 *Morganella morganii* and *Providencia rettgeri* in the API 20E system. *M. morganii* (top) and *P. rettgeri* (bottom) are urea (URE) and tryptophan deaminase (TDA) positive and H₂S negative. They also have similar TSI reactions. By observing the reactions shown here, one can easily see that the ornithine (ODC), citrate (CIT), mannitol (MAN), inositol (INO), and amygdalin (AMY) reactions, indicated by the arrows in the figure and the table below, readily distinguish the two species. The reactions of *M. morganii* and *P. rettgeri* are as follows.

Organism	ONPG	ADC	LDC	ODC	CIT	H ₂ S	URE	TDA	IND	VP	GEL	GLU	MAN	INO	SOR	RHA	SAC	MEL	AMY	ARA
<i>M. morganii</i> subsp. <i>morganii</i>	0	0	0	+	0	0	+	+	+	0	0	+	0	0	0	0	0	0	0	0
<i>P. rettgeri</i>	0	0	0	0	+	0	+	+	+	0	0	+	+	+	0	0	0	0	+	0
				↑	↑								↑	↑					↑	



Figure 12-21 *Providencia alcalifaciens* and *Providencia stuartii* in the API 20E system. This image shows the API 20E reactions of *P. alcalifaciens* (top) and *P. stuartii* (bottom). The only difference between these two species is the inositol (INO) reaction, indicated by the arrow.



Figure 12-22 *Edwardsiella tarda* on a TSI agar slant. *E. tarda* has the following reaction on TSI agar: alkaline/acid, H_2S positive. Other members of the *Enterobacterales* with a similar reaction are *Proteus mirabilis*, *Salmonella* spp., and some *Citrobacter* spp. *E. tarda* can be easily differentiated from these other organisms because it is citrate negative, while the others are citrate positive.



Figure 12-23 *Hafnia alvei* on a TSI agar slant. *H. alvei* has the following reaction on TSI agar slant: alkaline/acid. This organism was previously classified as an *Enterobacter* sp., and its reactions, including TSI, are very similar to those for organisms within this genus.



Figure 12-24 *Hafnia alvei* on MacConkey agar. Colonies of *H. alvei* are small (1 to 3 mm in diameter) and appear colorless on MacConkey agar. This organism was previously classified as an *Enterobacter* sp.; however, it is lactose negative, while the *Enterobacter* spp. are all lactose fermenters.



Figure 12-25 *Hafnia alvei* in the API 20E system. *H. alvei* is *o*-nitrophenyl- β -D-galactopyranoside (ONPG) and citrate (CIT) negative, while the *Enterobacter* spp. are positive for both reactions. Also, many of the *Enterobacter* spp. are sucrose (SAC) positive, but *H. alvei* is SAC negative.



Figure 12-26 *Plesiomonas shigelloides* on blood agar. Colonies of *P. shigelloides* on blood agar are approximately 2 to 3 mm in diameter, shiny, opaque, smooth, and nonhemolytic.

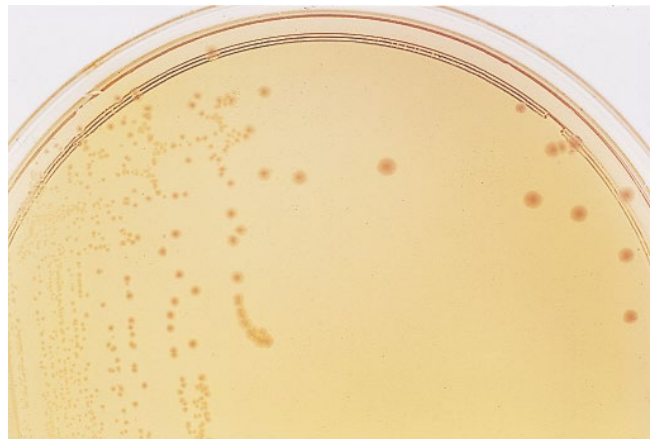


Figure 12-27 *Plesiomonas shigelloides* on MacConkey agar. Colonies of *P. shigelloides* on MacConkey agar are usually colorless or pinkish beige, measuring 1 to 2 mm in diameter. The colonies look very similar to those of *Shigella* spp.



Figure 12-28 *Plesiomonas shigelloides* on Hektoen agar. Colonies of *P. shigelloides* on Hektoen agar are colorless because the organism does not ferment sucrose. The colonies look very similar to those of *Shigella* spp. An oxidase test can quickly differentiate the two genera; however, it should be performed with colonies growing on a nonselective medium to avoid inaccurate results.

Yersinia

13

The genus *Yersinia*, a member of the order *Enterobacterales* in the family *Yersiniaceae* fam. nov., includes three pathogenic species, *Yersinia pestis*, *Yersinia enterocolitica*, and *Yersinia pseudotuberculosis*, along with an additional 15 species that are nonpathogenic to humans.

Y. pestis is known as the plague bacillus. The three forms of the disease are bubonic, pneumonic, and septicemic. Although bubonic plague is the most common form of the disease, pneumonic plague is the most serious, because the organisms can be transmitted by droplets from person to person. If untreated, the mortality rate ranges from 50 to 100%. Its natural reservoir is rodents, and it is transmitted to humans by the bite of infected fleas. In recent years, outbreaks have occurred in Africa, South America, and India. The organism can be isolated from blood, bubo aspirates, respiratory secretions, and cerebrospinal fluid.

Y. enterocolitica and *Y. pseudotuberculosis* are distributed worldwide, and infections due to these organisms are usually acquired by ingestion of contaminated food or water. *Y. enterocolitica* can cause enterocolitis in humans, and the disease may mimic acute appendicitis, because it can result in mesenteric lymphadenitis, which is associated with severe abdominal pain. This organism is found in the gastrointestinal tracts of many animal species, mostly dogs, rodents, and swine. Its growth is enhanced by cold temperatures, and therefore it is likely to be found in temperate and subtropical regions. The species is divided into six biogroups that can be differentiated biochemically: 1A, 1B, 2, 3, 4, and 5. Biotype 1B

appears to be the most pathogenic. The bioserotypes associated with human infections are 1B/O:8, 2/O:5,27, 2/O:9, 3/O:3, and 4/O:3. The latter is most common in the United States and Europe. The production of urease allows *Y. enterocolitica* to survive in the stomach and colonize the small intestine. It can multiply at 4°C; therefore, contaminated blood from an asymptomatic donor can transmit infection through a transfusion.

Y. pseudotuberculosis is primarily a pathogen of rodents, rabbits, and wild birds and rarely causes infections in humans. Although they are rare, infections usually occur in children and young adults. Septicemia occurs in immunosuppressed patients. As with *Y. enterocolitica*, infections result in mesenteric lymphadenitis, causing severe abdominal pain, which mimics acute appendicitis. It also can cause terminal ileitis, mimicking Crohn's disease and Far East scarlet-like fever. Other *Yersinia* spp. have been isolated from clinical specimens, but their pathogenicity has not been established. If they are isolated from fecal specimens, they should be reported as nonpathogenic yersiniae. The biochemical differentiation of the pathogenic *Yersinia* spp. is shown in Table 13-1.

Yersinia spp. are small, Gram-negative bacilli, approximately 0.5 to 0.8 µm wide and 1 to 3 µm long. All species except *Y. pestis* are motile. They grow both aerobically and anaerobically at temperatures ranging between 4 and 40°C, with optimal growth at 25 to 28°C; growth at ≥35°C is not consistent. Growth above 28°C may be delayed (>24 h), or inconsistent biochemical reactions

Table 13-1 Biochemical reactions of *Yersinia* spp. after incubation at 35°C^a

Species	Indole	Motility at 25°C	Urea	Ornithine	Sucrose	Rhamnose	Melibiose
<i>Y. pestis</i>	0	0	0	0	0	0	V
<i>Y. enterocolitica</i>	V	+	+	+	+	0	0
<i>Y. pseudotuberculosis</i>	0	+	+	0	0	+	+

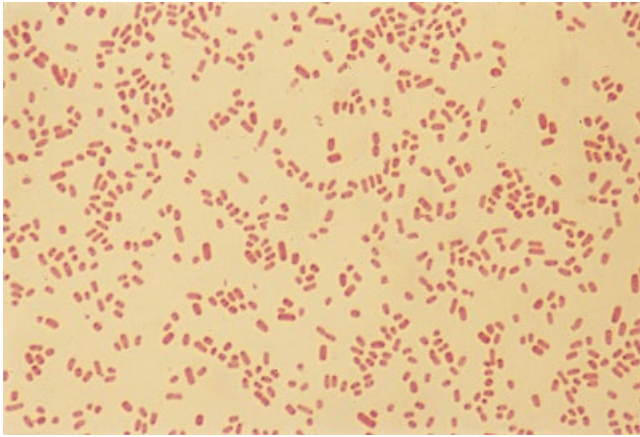
^a+, positive reaction (≥90% positive); V, variable reaction (11 to 89% positive); 0, negative reaction (≤10% positive).

may occur. However, commercial identification systems are based on results obtained at 35°C. Preferred media include blood agar, as well as MacConkey agar and cefsulodin-irgasan-novobiocin (CIN) agar, which is the recommended medium if *Yersinia* is suspected from fecal specimens. Growth of many strains of *Y. pseudotuberculosis* may be inhibited on CIN agar and on CHROMagar *Yersinia*, and therefore, MacConkey agar is preferred for isolation. On CIN agar, colonies of *Y. enterocolitica* are approximately 2 mm in diameter and usually have red centers surrounded by a translucent zone. *Aeromonas* spp. can have a similar appearance; however, they are oxidase positive. *Yersinia* spp. ferment glucose, reduce nitrate to nitrite, and are catalase positive. All species except *Y. pestis* are also urea positive at 25 to 28°C; however, the reaction may be negative at 35°C. Ornithine is decarboxylated by most *Yersinia* spp.; the exceptions are *Y. pestis* and *Y. pseudotuberculosis*. For identification, the API 20E system (bioMérieux, Inc., Durham, NC) seems to have the greatest sensitivity and specificity for *Y. enterocolitica* and *Y. pseudotuberculosis*.

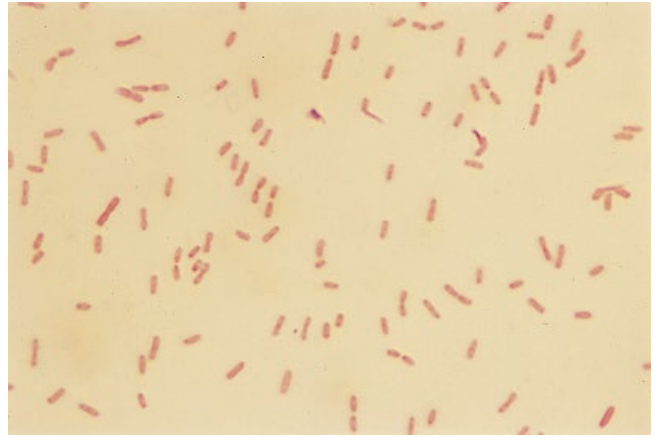
Y. pestis is best seen when stained with Giemsa, Wright's, Wayson, or methylene blue stain rather than the Gram stain. The organisms are small (1 to 2 μm by 0.5 μm), Gram-negative bacilli and may appear bipolar, resembling safety pins, when isolated from clinical material; however, this bipolar morphology is not seen in Gram stains or from colonies grown on culture media. On solid media, *Y. pestis* appears as pinpoint colonies after a 24-h

incubation at 35°C. Colonies are usually nonhemolytic on blood agar and mucoid on brain heart infusion agar and look like fried eggs after prolonged incubation. In a broth medium, organisms tend to clump along the side of the tube and then fall to the bottom after a 24-h incubation. The metabolic activity of this organism is best demonstrated at 13 to 25°C. Prolonged incubation (2 to 5 days) may be necessary to determine the biochemical reactions.

Automated systems may misidentify *Y. pestis* as *Y. pseudotuberculosis* or as *Salmonella*, *Shigella*, or *Acinetobacter*. If the organism is catalase positive and oxidase, indole, and urease negative, *Y. pestis* cannot be ruled out. Therefore, the isolate should be sent to a reference laboratory within the Laboratory Response Network (LRN), especially if the identification does not agree with the clinical picture. The CDC guidelines state that any specimen suspected of containing *Y. pestis* should be processed under biosafety level 3 (BSL3) conditions or BSL2 conditions with BSL3 precautions (<https://www.cdc.gov/biosafety/publications/bmbl5/>). *Y. pestis* is classified as a tier 1 agent; therefore, Sentinel Level Clinical Laboratory Microbiology Guidelines should be followed, and they are available on the American Society for Microbiology website (<https://www.asm.org/Articles/Policy/Laboratory-Response-Network-LRN-Sentinel-Level-C>). They offer standardized, practical methods to aid microbiologists in ruling out select agents and referring specimens to LRN reference laboratories for confirmation.



A



B

Figure 13-1 Gram stain of *Yersinia enterocolitica* and *Yersinia pestis*. (A) *Yersinia* spp. are small, plump, Gram-negative bacilli, measuring approximately 0.8 μm in width and 2 μm in length. These cells appear coccoid with bipolar staining. (A) *Y. enterocolitica*. (B) *Y. pestis* is coccoid or rod shaped. The appearance of *Yersinia* spp. in the Gram stain is similar to that of other members of the order *Enterobacterales*.

Figure 13-2 *Yersinia enterocolitica* on blood agar. Colonies of *Y. enterocolitica* are small and gray to grayish white, measuring 1 to 2 mm in diameter after overnight incubation at 35°C under 5% CO_2 .

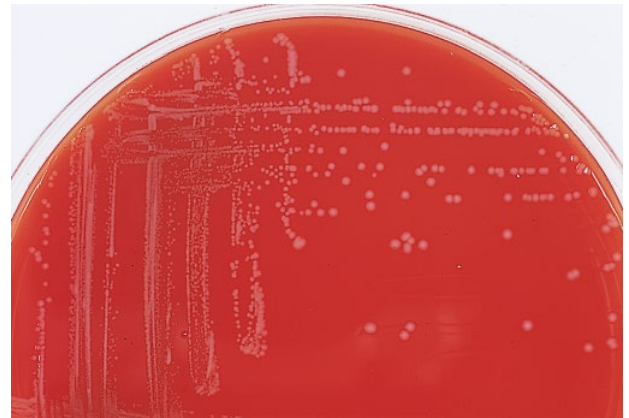
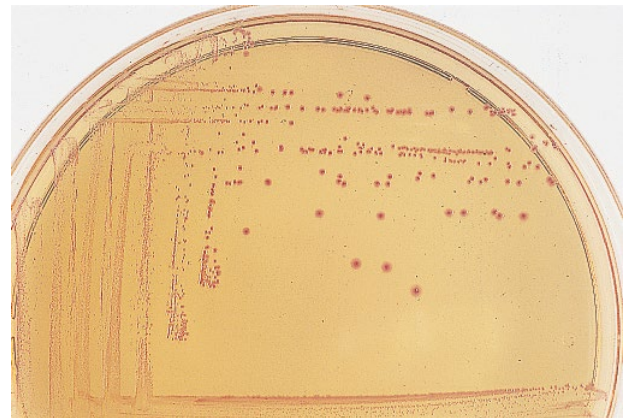
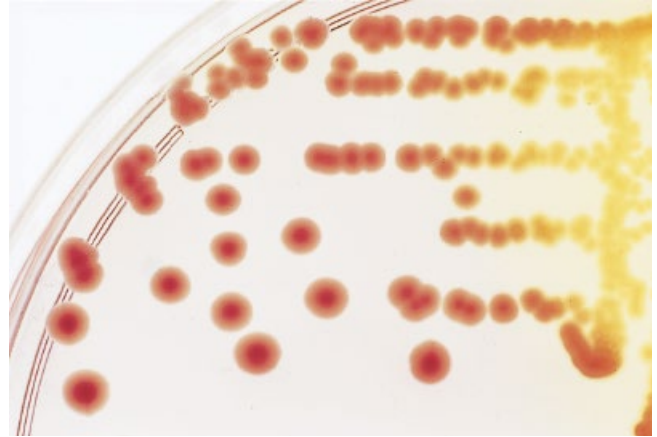


Figure 13-3 *Yersinia enterocolitica* on MacConkey agar. *Y. enterocolitica* is a lactose nonfermenter; therefore, colonies appear colorless or transparent on MacConkey agar. Colonies are small compared to those of other members of the *Enterobacterales*, ranging in size from 1 to 3 mm after overnight incubation at 35°C. Incubation at 25°C for 48 h enhances their growth.





A



B

Figure 13-7 *Yersinia enterocolitica* on CIN agar incubated at 25°C for 24 and 48 h. CIN agar is an excellent medium for the isolation of *Y. enterocolitica*, especially from fecal specimens. For optimal growth, the specimen should be inoculated onto the medium and incubated at 25°C for 48 h. Colonies of *Y. enterocolitica* appear bright pink with a red center surrounded by a translucent zone, giving the typical appearance of a bull's-eye. Very few other organisms grow on this medium, the exception being *Aeromonas* spp. (A) Colonies incubated for 24 h at 25°C. They measure approximately 1 mm in diameter. (B) Colonies incubated for 48 h at 25°C. These colonies measure approximately 3 to 4 mm in diameter.



Figure 13-8 *Yersinia pestis* on blood agar. Colonies of *Y. pestis* on blood agar are pinpoint at 24 h, as shown here. On prolonged incubation, they can exhibit a rough, cauliflower-like appearance. When grown in a broth medium, the colonies form clumps of cells that adhere to one side of the tube, resembling a stalactite pattern or hammered copper.

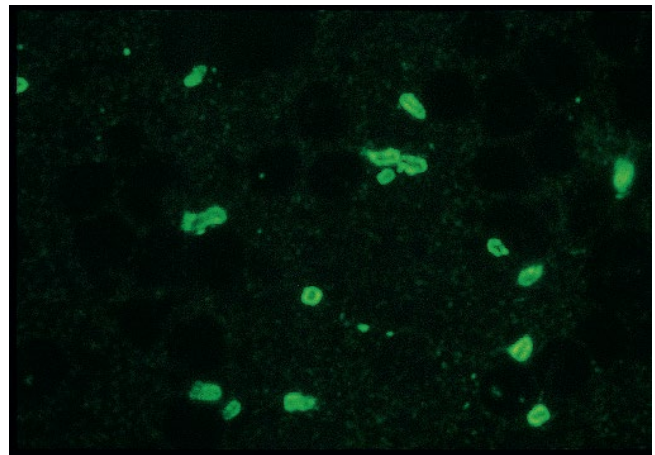


Figure 13-9 Direct fluorescent-antibody stain of *Yersinia pestis*. Direct microscopic detection of the *Y. pestis* capsular F1 antigen is performed using a fluorescent-antibody stain, as shown here. A positive immunofluorescence stain indicates a presumptive diagnosis of infection with the plague bacillus.

Vibrionaceae

14

Vibrio spp. are classified in the family *Vibrionaceae* along with five other genera: *Aliivibrio*, *Enterovibrio*, *Grimontia*, *Photobacterium*, and *Salinivibrio*. Pathogenic species are found in the genera *Vibrio* (13 species), *Grimontia* (1 species), and *Photobacterium* (1 species). Of these, *Vibrio cholerae*, *Vibrio parahaemolyticus*, and *Vibrio vulnificus* are the most frequently isolated, followed by *Vibrio alginolyticus*, *Vibrio mimicus*, and *Vibrio fluvialis*. The remaining *Vibrio* spp. are rarely encountered. This chapter describes the most common *Vibrionaceae* causing infections in humans.

The *Vibrionaceae* are isolated mainly in marine environments. They cause both intestinal and extraintestinal infections that occur more frequently during the warmer months and usually occur following consumption of raw fish or as a result of wounds associated with contact with contaminated fish and water.

V. cholerae is divided into three major subgroups—*V. cholerae* O1, *V. cholerae* O139, and *V. cholerae* non-O1—and more than 200 serogroups. The most important pathogens in this group are *V. cholerae* serogroups O1 and O139, since they cause endemic, epidemic, and pandemic cholera. There are two biotypes of *V. cholerae* O1: classical and El Tor. The classical biotype was responsible for six of the seven historical pandemics, while the El Tor biotype was responsible for the seventh pandemic, which began in 1961. The El Tor biotype may be differentiated from the classical biotype since it is

Voges-Proskauer positive, hemolyzes erythrocytes, and is inhibited by polymyxin B, whereas the classical biotype has the opposite reactions.

In 2016, the World Health Organization (WHO) reported more than 130,000 cases of cholera worldwide. During the past 2 decades, a majority of cases occurred in Africa, with the exception of 2010 to 2012, when an epidemic occurred in Haiti. Almost 800,000 cases have been reported in Haiti through 2016. Cholera cases in the United States usually occur in individuals who have traveled to areas where cholera is endemic.

In 1992, an epidemic of cholera occurred in India, Bangladesh, and elsewhere in Asia. The new subgroup of *V. cholerae* was designated O139 to distinguish it from the other somatic antigen groups of *V. cholerae* known prior to 1998. O139 and O1 strains carry similar virulence factors, including the *ctx* and *tcpA* genes. In 2002, O139 reemerged in Bangladesh, causing 30,000 cases. According to the WHO report, most of the *V. cholerae* O139 infections in Asia were reported from China. In contrast, <0.5% of cholera cases reported from Thailand were caused by the O139 type and no cases of O139 infection were reported from Africa.

The epidemiological characteristics of serogroup O139 are similar to those of serogroup O1. The isolation and identification characteristics of serogroup O139 are identical to those of serogroup O1; therefore, antiserum to serogroup O139 is needed for definitive identification. The severe symptoms caused

by these serogroups are the result of cholera toxin. The clinical presentation of cholera ranges from an asymptomatic infection to a severe form, resulting in watery diarrhea known as rice water stools, with a fluid loss of 500 to 1,000 ml/h. The fulminant form is attributed to the *ctx* and *tcpA* genes. Fluid and electrolyte replacement is the recommended treatment. In recent years, new variants of *V. cholerae* O1 have emerged in Africa and Asia. These variants are referred to as hybrid El Tor strains, which may be more virulent than most El Tor strains.

V. cholerae non-O1 (non-O1, non-O139), the non-epidemic-associated cholera organism, is the fourth most commonly isolated vibrio in the United States following *V. parahaemolyticus*, *V. alginolyticus*, and *V. vulnificus*. *V. cholerae* non-O1 usually does not produce cholera toxin, although it may produce other toxins. The non-O1 *V. cholerae* causes self-limiting gastroenteritis, sepsis, and wound infections. *V. mimicus* is very similar to *V. cholerae* non-O1 with respect to clinical presentation and the characteristics of the organism. For these reasons, it was previously classified as sucrose-negative *V. cholerae*.

V. alginolyticus is the second most frequently isolated *Vibrio* sp. in the United States. It is closely related to *V. parahaemolyticus* and may be differentiated on the basis of its ability to grow in 10% NaCl and ferment sucrose. It is Voges-Proskauer positive, and it can swarm on blood agar due to the formation of evenly distributed/peritrichous flagella. Infections are extraintestinal (e.g., ear and wound infections) after exposure to seawater. Although *V. alginolyticus* may be isolated from stool specimens, it is not known to cause diarrhea.

V. parahaemolyticus is frequently associated with gastroenteritis following the consumption of raw, contaminated fish or shellfish. In Japan, a majority of food-borne diarrhea is due to *V. parahaemolyticus*. In the United States, it is the *Vibrio* species most frequently isolated from clinical specimens. The infection is usually self-limited, with watery, sometimes bloody, diarrhea lasting 2 to 3 days. Urease-positive strains are thought to be more virulent than urease-negative ones, and this has been linked to the production of thermostable direct hemolysin, a hemolysin that lyses human erythrocytes.

V. vulnificus is associated with very severe disease and a high mortality rate. It causes septicemia and

wound infections, usually following the consumption or handling of raw oysters. The disease is known to occur mainly in individuals with preexisting liver disease. It appears that the increased availability of iron resulting from the liver disease puts these individuals at increased risk of acquiring the infection.

The two genera previously included in the *Vibrio* spp., *Photobacterium damsela* and *Grimontia hollisae*, are referred to as *Vibrio*-like organisms. Infections with *P. damsela* can be life-threatening, with a high mortality rate. The organism can cause bacteremia, cellulitis, and necrotizing fasciitis. It is known to be an occupational disease of fishermen. Serious infection occurs within hours after exposure, which requires immediate medical attention. Like most of the other *Vibrionaceae*, the organism is oxidase positive and grows in 6% NaCl. It is Voges-Proskauer and arginine positive, while most other conventional phenotypic tests are negative.

G. hollisae causes severe diarrhea, which can result in bacteremia or hypovolemic (low volume) shock as a result of the loss of a large volume of blood or plasma. As described for other *Vibrio* infections, the infection is due to the consumption of raw or improperly cooked seafood, e.g., oysters. It is oxidase and ornithine positive and negative for other phenotypic tests used to identify the *Vibrionaceae*. Unlike other *Vibrionaceae*, it does not grow on thiosulfate-citrate-bile salts-sucrose (TCBS) agar. The remaining members of the pathogenic *Vibrionaceae* are less commonly isolated.

Vibrio spp. are curved or straight, Gram-negative bacilli measuring approximately 0.5 to 0.8 μm wide and 1.5 to 2.5 μm long. Most species are motile by means of a polar flagellum, whereas those that swarm on agar media are peritrichous. All *Vibrio* spp. ferment glucose. However, with the exception of *Vibrio metschnikovii*, all other *Vibrio* spp. are oxidase and catalase positive and reduce nitrate to nitrite. *Vibrio* spp. grow best on nutrient agar or in broth in the presence of NaCl. Apart from the nonhalophilic species, *V. cholerae* and *V. mimicus*, they do not grow without at least 0.5% NaCl. Most primary culture media contain at least 0.5% NaCl; therefore, *Vibrio* spp. grow well on blood and MacConkey agars. However, in a suspected outbreak, the use of a selective medium such as TCBS agar may be helpful, especially when the specimen source is feces. Inclusion of sucrose in this medium allows the

differentiation of *V. cholerae* and *V. alginolyticus* from some of the other pathogenic *Vibrio* spp. because they produce yellow colonies due to the fermentation of sucrose, whereas most of the other *Vibrio* spp. are sucrose negative and appear as green colonies.

The string test is very helpful in differentiating *Vibrio* spp. from closely related organisms such as *Aeromonas* and *Plesiomonas* spp. In this test, *Vibrio* spp. are lysed in the presence of 0.5% sodium deoxycholate, resulting in a positive string test, whereas *Aeromonas* and *Plesiomonas* give negative results. Other key tests that assist in the identification of *Vibrio* spp. are the oxidase test, reactions on a triple sugar iron (TSI) agar slant, *o*-nitrophenyl- β -D-galactopyranoside, lysine decarboxylase, ornithine decarboxylase, and arginine dihydrolase. Key differentiating characteristics of the *Vibrionaceae* are shown in Table 14-1. The accuracies of commercial systems vary for the identification of *Vibrio* spp.

Identification by matrix-assisted laser desorption ionization-time of flight mass spectrometry has been reported to be comparable to sequencing for the most frequently isolated *Vibrio* spp. However, not all database versions include all pathogenic *Vibrio*. Molecular detection of *Vibrio* spp. has been described, although few such tests are commercially available. PCR-based assays have the advantage over culture methods in that fecal specimens can be frozen and tested at a later time. Molecular identification of vibrios is not routinely performed in clinical laboratories because vibrios are rarely isolated in noncoastal areas or where cholera is not endemic.

Isolates of *V. cholerae* O1 and O139 should be immediately reported and submitted to a public health laboratory for confirmation and toxin testing. For surveillance purposes, all *Vibrionaceae* isolates should also be sent to the public health laboratory.

Table 14-1 *Vibrionaceae* isolated from clinical specimens^a

Species	Oxidase	Motility	ONPG	ADH	LDC	ODC	0% NaCl	6% NaCl	Salicin	Sucrose
<i>Vibrio</i>										
<i>V. alginolyticus</i>	+	+	0	0	+	V	0	+	0	+
<i>V. cincinnatiensis</i>	+	V	V	0	V	0	0	+	+	+
<i>V. cholerae</i>	+	+	+	0	+	+	+	V	0	+
<i>V. fluvialis</i>	+	V	V	+	0	0	0	+	0	+
<i>V. furnissii</i>	+	V	V	+	0	0	0	+	0	+
<i>V. harveyi</i>	+	0	0	0	+	0	0	+	0	V
<i>V. metschnikovii</i>	0	V	V	V	V	0	0	V	0	+
<i>V. mimicus</i>	+	+	+	0	+	+	+	V	0	0
<i>V. parahaemolyticus</i>	+	+	0	0	+	+	0	+	0	0
<i>V. vulnificus</i>	+	+	V	0	+	V	0	V	+	V
<i>Grimontia hollisae</i>	+	0	0	0	0	+	0	V	0	0
<i>Photobacterium damsela</i>	+	V	0	+	V	0	0	+	0	0

^aONPG, *o*-nitrophenyl- β -D-galactopyranoside; ADH, arginine dihydrolase; LDC, lysine decarboxylase; ODC, ornithine decarboxylase; +, positive reaction ($\geq 90\%$ positive); V, variable reaction (11 to 89% positive); 0, negative reaction ($\leq 10\%$ positive).

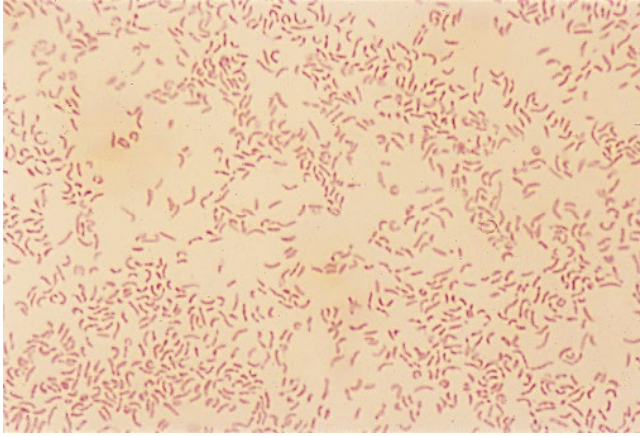


Figure 14-1 Gram stain of *Vibrio* spp. A Gram stain of *Vibrio* spp. shows typical curved and straight, Gram-negative bacilli measuring approximately 0.5 to 0.8 μm wide and 1.5 to 2.5 μm long.



Figure 14-2 *Vibrio cholerae* on blood agar. Colonies of *V. cholerae* on blood agar are small to medium, measuring approximately 1 to 3 mm in diameter, nonhemolytic, smooth, and opaque, with a greenish hue.

Figure 14-3 *Vibrio alginolyticus* on blood agar. Colonies of *V. alginolyticus* on blood agar are medium to large, measuring approximately 3 to 5 mm in diameter; nonhemolytic; smooth; and opaque, with a slight greenish hue. Most *Vibrio* spp. are nonhemolytic, with the exception of *V. fluvialis* and *V. mimicus*. *V. alginolyticus* can swarm on blood agar due to the formation of peritrichous flagella. Shown in this image are narrow areas of spreading surrounding the isolated colonies, unlike *Proteus* spp., which can cover the entire surface of the agar.



Figure 14-4 *Vibrio cholerae* on TCBS agar. TCBS agar is a selective medium developed for the isolation of *Vibrio* spp., especially *V. cholerae*, from fecal specimens. Some *Vibrio* spp. grow poorly on this medium, while others grow well and produce yellow or green colonies, depending on whether they ferment sucrose. *V. cholerae* is a sucrose fermenter; as shown in this figure, the colonies are yellow. TCBS agar should be incubated at 35°C in ambient air rather than in 5 to 10% CO_2 .

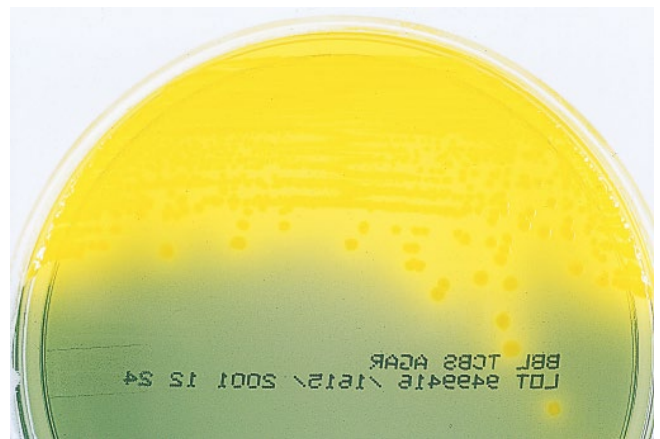




Figure 14-5 *Vibrio alginolyticus* on TCBS agar. TCBS agar is not selective for *V. cholerae* alone. Other species also ferment sucrose, including *V. metschnikovii*, *V. fluvialis*, *V. alginolyticus* (shown here), and some strains of *V. vulnificus*. Colonies of *V. alginolyticus* on TCBS are larger than those of *V. cholerae* (Fig. 14-4).



Figure 14-6 *Vibrio parahaemolyticus* on TCBS agar. Unlike the *Vibrio* spp. in Fig. 14-4 and 14-5, *V. parahaemolyticus* does not ferment sucrose, and therefore, the colonies are green on TCBS agar.



Figure 14-7 *Vibrio parahaemolyticus* on blood agar. Colonies of *V. parahaemolyticus* on blood agar are very similar to those of *V. cholerae* (Fig. 14-2), although they are slightly larger, measuring 2 to 4 mm in diameter, with a darker greenish coloration.

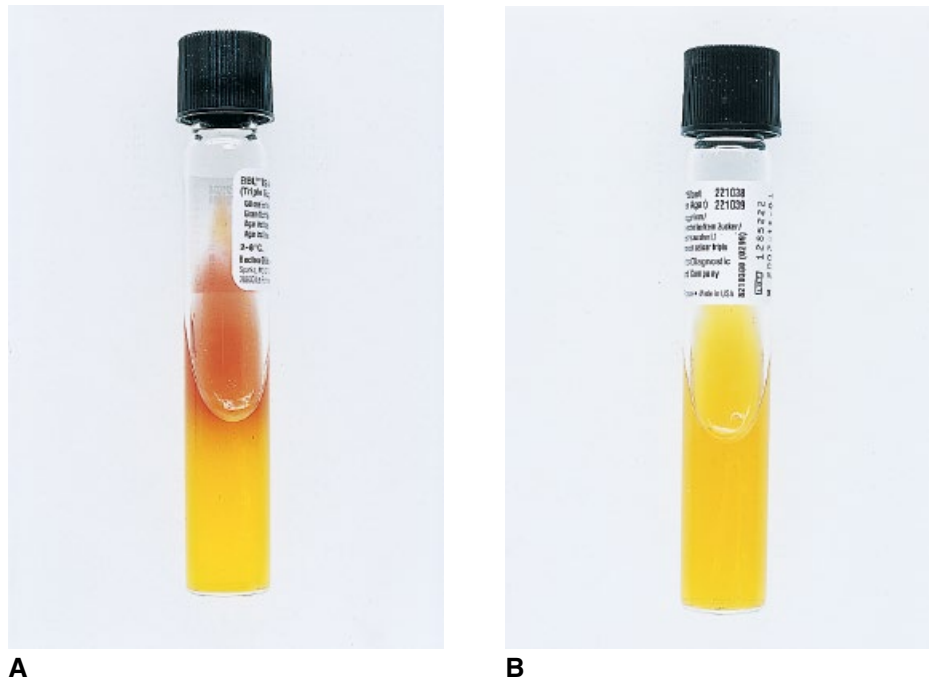


Figure 14-8 *Vibrio* spp. on a TSI agar slant. *Vibrio* spp. grow well on a TSI agar slant. Since they ferment glucose without gas production, the reaction in the butt of the tube is acid (yellow). The reaction in the slant depends on whether the organism ferments lactose and/or sucrose. (A) *V. parahaemolyticus* does not ferment lactose or sucrose, and therefore, the slant is alkaline (pink). (B) *V. alginolyticus* ferments sucrose and therefore gives an acid (yellow) reaction in the TSI agar slant.



Figure 14-9 *Vibrio alginolyticus* identified by the API 20E system. Identification of *Vibrio* spp. by commercial systems is unreliable. However, more commonly isolated species, such as *V. alginolyticus*, are included in the databases. The positive reactions in this API 20E test (bioMérieux, Inc., Durham, NC), shown above the arrows, are characteristic of *V. alginolyticus*, including lysine decarboxylase (LDC), indole (IND), glucose (GLU), and sucrose (SAC). The identification is based on the combination of these reactions, along with a positive oxidase test.



Figure 14-10 *Vibrio alginolyticus* and *Aeromonas hydrophila* inoculated into 6.5% NaCl broth. The growth of *Vibrio* spp. on primary culture media is very similar to that of *Aeromonas* and *Plesiomonas* spp., all three of which are oxidase positive. One of the distinguishing characteristics of the *Vibrio* spp. is their ability to grow in the presence of high concentrations of NaCl. In this figure, *V. alginolyticus* is growing in 6.5% NaCl (left) but *A. hydrophila* shows no growth (right). The 6.5% NaCl broth also contains glucose and an indicator; the medium becomes acid (yellow) due to the fermentation of glucose.



Figure 14-11 *Vibrio alginolyticus* and *Aeromonas hydrophila* inoculated on nutrient agar. Most *Vibrio* spp. require NaCl for growth. Here, one nutrient agar slant was inoculated with *A. hydrophila* (left) and the other was inoculated with *V. alginolyticus* (right). Since the nutrient agar does not contain sufficient NaCl to support the growth of *V. alginolyticus*, growth appears only in the tube inoculated with *A. hydrophila*.



Figure 14-12 *Vibrio mimicus* on blood agar. Most *Vibrio* spp. are nonhemolytic; however, two species can be beta-hemolytic: *V. fluvialis* and *V. mimicus*. In this image, colonies of *V. mimicus* on blood agar are medium to large, measuring 4 to 5 mm in diameter, and are surrounded by wide zones of beta-hemolysis. *P. damsela* is also beta-hemolytic.



Figure 14-13 Presumptive identification of *Vibrio* spp. by the string test. The string test is used to differentiate *Vibrio* from other related organisms, such as *Aeromonas* and *Plesiomonas*. Suspected colonies are suspended in 0.5% sodium deoxycholate on a glass slide. *Vibrio* spp. lyse when mixed with this reagent, forming a viscous suspension. A string of viscous material appears when the suspension is pulled away from the test surface with a loop, as shown here.

Aeromonas

15

Aeromonas spp. belong to the family *Aeromonadaceae* along with the genera *Oceanimonas* and *Tolumonas*; however, *Aeromonas* is the only genus pathogenic for humans. Of the 36 species and subspecies classified in the genus *Aeromonas*, only 13 have been isolated from clinical specimens. Most of the human pathogens are in the *Aeromonas hydrophila* complex, which includes *Aeromonas hydrophila* subsp. *hydrophila* and *Aeromonas dhakensis*; the *Aeromonas caviae* complex including *A. caviae* and *Aeromonas rivipollensis*; *Aeromonas veronii* complex including *A. veronii* biovar *sobria*, *A. veronii* biovar *veronii*, *Aeromonas diversa*, *Aeromonas jandaei*, *Aeromonas schubertii*, and *Aeromonas trota*; and other *Aeromonas* species, including *Aeromonas popoffii*, *Aeromonas sanarellii*, and *Aeromonas taiwanensis*.

Improved taxonomy has identified *A. dhakensis* as one of the most frequently isolated species as well as the most virulent. In the past, this organism may have been misidentified as *A. hydrophila*. *A. caviae*, *A. dhakensis*, *A. hydrophila* subsp. *hydrophila*, and *A. veronii* represent >90% of *Aeromonas* spp. causing infections in humans.

The genus *Aeromonas* is widely distributed in aquatic and marine environments. The aeromonads not only produce disease in humans but also cause infections in fish and cold-blooded animals. Humans become infected during the warmer months through a variety of pathways. Water is often the source for infection, and the organisms are thus acquired through the environment and recreational activities; however, consumable products, pets, and zoonoses have also been implicated in transmission. *Aeromonas* spp. cause a wide variety of intestinal and extraintestinal

disease ranging from a self-limiting gastroenteritis to life-threatening infections, including septicemia and necrotizing fasciitis. Although rare, other infections have been reported, including genitourinary, ocular, respiratory, and surgical infections. Previously, *Aeromonas* spp. appeared to represent a low risk to human health. However, following natural disasters early in the 21st century, including flooding in New Orleans and the tsunami in Thailand, *Aeromonas* spp. were a significant cause of infection. There is also an increased risk of *Aeromonas* infection following medicinal leech therapy, since leeches harbor aeromonads in their gut. The *Aeromonas* spp. most commonly associated with these infections include *A. caviae*, *A. dhakensis*, *A. hydrophila*, and *A. veronii* biovar *sorbia*.

Aeromonas spp. are small, Gram-negative bacilli and coccobacilli, 1.0 to 4.0 μm long and 0.3 to 1.0 μm wide. Most species are motile by means of a single polar flagellum; however, peritrichous lateral flagella may be observed in cultures that are <8 h old. *Aeromonas* spp. grow well on routine laboratory media, including blood and MacConkey agars, and approximately 90% of isolates are beta-hemolytic on blood agar, with the exception of *A. popoffii*, which is nonhemolytic. The use of modified cefsulodin-irgasan-novobiocin (CIN) agar containing 4 $\mu\text{g}/\text{ml}$ of cefsulodin may be helpful when attempting to isolate the organism from feces. Other media, such as blood agar containing 20 $\mu\text{g}/\text{ml}$ of ampicillin, have been used to enhance the recovery of aeromonads from feces. However, ampicillin-susceptible species, e.g., *A. trota*, are inhibited. *Aeromonas* agar is another selective medium for the isolation of aeromonads. It is a highly selective

medium containing D-xylose, which *Aeromonas* spp. do not ferment. This reaction differentiates *Aeromonas* spp. from *Yersinia* spp. and *Citrobacter* spp., the two genera with colony morphology similar to that of *Aeromonas* on CIN agar. Another advantage is that an oxidase test can be performed directly from colonies on *Aeromonas* agar but not from colonies on CIN agar.

Aeromonas spp. are oxidase and catalase positive, reduce nitrate to nitrite, and ferment glucose along with other carbohydrates. However, not all aeromonads produce gas from glucose. Other than *A. schubertii* and an occasional strain of *A. caviae*, most species are indole positive. The aeromonads grow over a wide range of temperatures (10 to 42°C). It is recommended that beta-hemolytic colonies on blood agar be screened with matrix-assisted laser desorption ionization-time of flight mass spectrometry (MALDI-TOF MS) or oxidase and a spot indole test. Use of commercial systems, 16S rRNA sequencing, MALDI-TOF MS, and conventional biochemical methods can identify *Aeromonas* spp. to the genus level, although their performance decreases when identification to the species level is needed, depending on the method. The reason that identification of these organisms may present a problem is that not all of the species

appear in the databases, resulting in misidentification, although the more common clinical isolates are usually included. If conventional tests are used to identify *Aeromonas* spp., they may be misidentified as *Plesiomonas shigelloides* or *Vibrio* spp. If arginine, lysine, and ornithine are positive when tested in Moeller's medium and inositol is fermented, the organism most likely is *Plesiomonas*. *Aeromonas* spp. are not easily differentiated from *Vibrio* spp., especially when tested with commercial systems. A positive string test differentiates *Vibrio* spp. from *Aeromonas* spp. Since both *Aeromonas* and *Pseudomonas* spp. are oxidase positive, they may be differentiated based on fermentation of glucose; *Aeromonas* spp. ferment glucose and *Pseudomonas* spp. do not. In addition, *Aeromonas* spp. are indole positive, while the majority of *Pseudomonas* spp. are indole negative.

Fortunately, it is not necessary to definitively identify members of the *A. hydrophila* complex or *A. caviae* complex isolated from feces. On the other hand, it is important to distinguish *A. hydrophila* and *A. veronii* biovar *sobria* from other *Aeromonas* spp., because they can cause serious, aggressive extraintestinal infections. Fermentation of L-arabinose and esculin hydrolysis are the two most helpful tests in differentiating these two species (Table 15-1).

Table 15-1 Differentiation of *Aeromonas* spp. encountered in clinical specimens^a

Species	Esculin hydrolase	Voges-Proskauer	Gas from glucose	LDC	ADH	ODC
<i>A. caviae</i> complex						
<i>A. caviae</i>	+	0	0	0	+	0
<i>A. rivipollensis</i>	+	0	0	0	+	0
<i>A. hydrophila</i> complex						
<i>A. dhakensis</i>	+	+	+	+	+	0
<i>A. hydrophila</i> subsp. <i>hydrophila</i>	+	+	+	+	+	0
<i>A. veronii</i> complex						
<i>A. veronii</i> biovar <i>sobria</i>	0	+	+	+	+	0
<i>A. veronii</i> biovar <i>veronii</i>	+	+	+	+	0	+
<i>A. jandaei</i>	0	+	+	+	+	0
<i>A. schubertii</i>	0	V	0	+	+	0
<i>A. trota</i>	0	0	V	+	+	0
Other <i>Aeromonas</i> spp.						
<i>A. popoffii</i>	0	+	+	0	+	0
<i>A. sanarellii</i>	0	0	0	0	+	0
<i>A. taiwanensis</i>	+	0	0	0	+	0

^aLDC, lysine decarboxylase; ADH, arginine dihydrolase; ODC, ornithine decarboxylase; +, positive reaction (>85% positive); V, variable reaction (15 to 85% positive); 0, negative reaction (<15% positive).

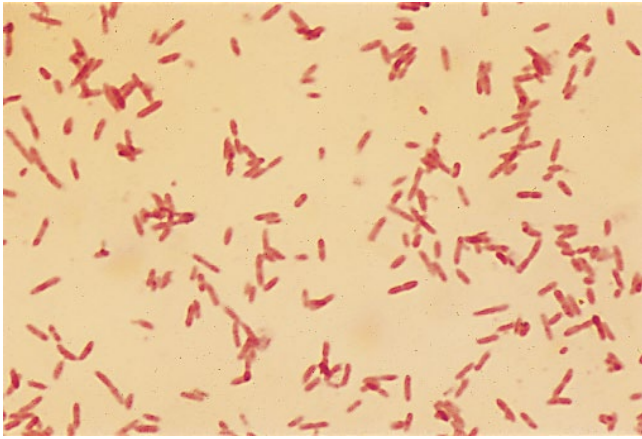


Figure 15-1 Gram stain of *Aeromonas hydrophila*. *A. hydrophila* appears as small, straight, Gram-negative bacilli and coccobacilli, 1.0 to 4.0 μm long and 0.3 to 1.0 μm wide.

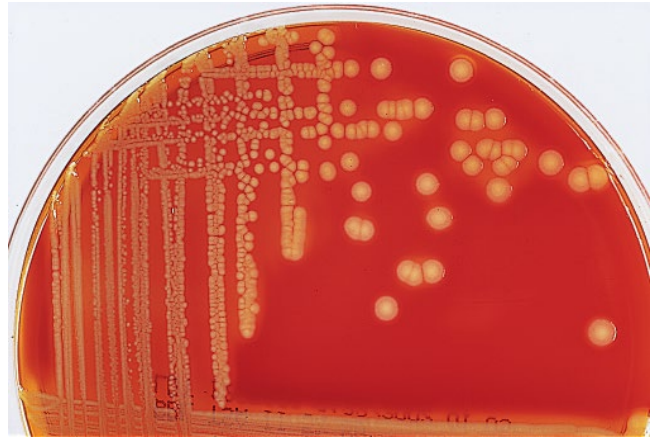


Figure 15-2 *Aeromonas hydrophila* on blood agar. Colonies of *A. hydrophila* on blood agar are approximately 4 mm in diameter, round, raised, opaque, and beta-hemolytic. This is characteristic of most species of *Aeromonas*, except *A. caviae*, which is usually non-hemolytic. Colonies of *Aeromonas* spp. can be confused with enteric Gram-negative bacilli, although *Aeromonas* spp. are usually more opaque.

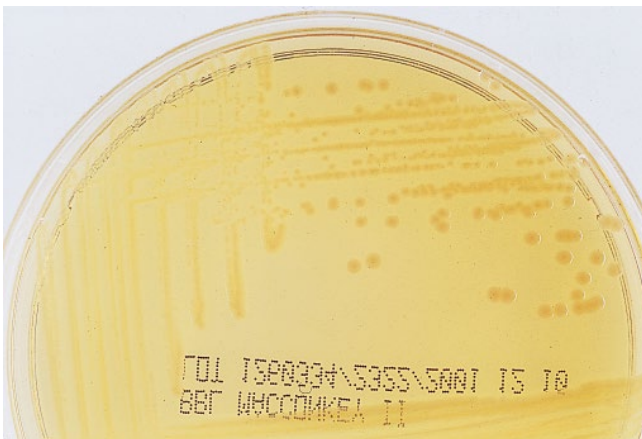


Figure 15-3 *Aeromonas hydrophila* on MacConkey agar. Colonies of *A. hydrophila* on MacConkey agar are lactose nonfermenting, appearing as colorless or pinkish beige. This is characteristic of most species of *Aeromonas*, except *A. caviae*, which ferments lactose, resulting in pink colonies on this medium.



Figure 15-4 *Aeromonas hydrophila* on Hektoen agar. *A. hydrophila* grows well on Hektoen agar, producing yellow colonies because it ferments sucrose. These colonies are similar in appearance to colonies of many of the nonpathogenic enteric organisms; therefore, it is difficult to differentiate them from members of the normal intestinal microbiota in fecal specimens.

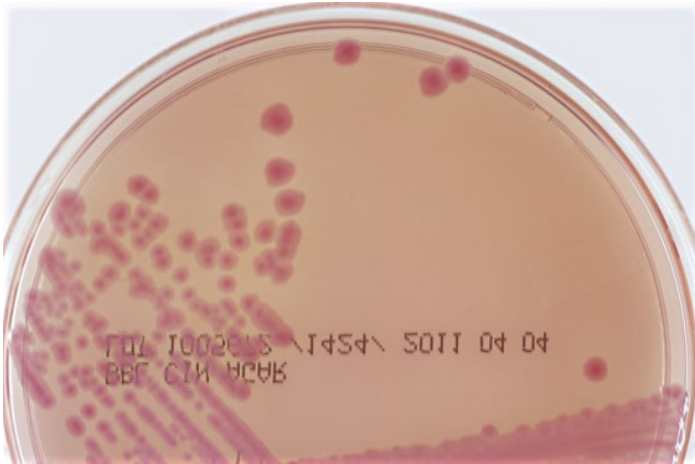


Figure 15-5 *Aeromonas caviae* on CIN agar. CIN agar is an excellent isolation medium for aeromonads. On this medium, *Aeromonas* spp. colonies have a pink center surrounded by an uneven, clear area. *Yersinia enterocolitica* has a similar appearance on this medium.



Figure 15-6 *Aeromonas hydrophila* and *Aeromonas caviae* identified by the API 20E system. Both *A. hydrophila* and *A. caviae* are included in the API 20E (bioMérieux, Inc., Durham, NC) database; therefore, this system can be used to identify these two *Aeromonas* spp. In this example, *A. caviae* appears in the top strip and *A. hydrophila* is in the bottom strip. The reactions that differentiate them, indicated by arrows, are Voges-Proskauer (VP) and amygdalin (AMY). *A. hydrophila* is VP positive (red), while *A. caviae* is negative (no color). *A. caviae* is AMY positive (yellow), while *A. hydrophila* is negative (blue). The combination of the reactions in each of the strips, as well as the positive oxidase reactions, confirms the identification of these two isolates.

Pseudomonas

16

Twelve *Pseudomonas* spp. have been found in clinical specimens: *Pseudomonas aeruginosa*, *Pseudomonas alcaligenes*, *Pseudomonas fluorescens*, *Pseudomonas luteola*, *Pseudomonas mendocina*, *Pseudomonas monteilii*, *Pseudomonas mosselii*, *Pseudomonas oryzae*, *Pseudomonas pseudoalcaligenes*, *Pseudomonas putida*, *Pseudomonas stutzeri*, and *Pseudomonas veronii*. There are several other *Pseudomonas* spp.; however, they are saprophytes or plant pathogens.

Pseudomonas spp. are widely distributed in the environment and are often found in moist areas, where they can grow as biofilms attaching to surfaces. This has caused problems in hospitals, because they have been isolated from a variety of aqueous solutions, including dialysis and irrigation fluids, and the instruments and equipment associated with them.

P. aeruginosa is a member of the normal microbiota of the intestinal tract. It is by far the most frequent cause of health care-related infections and the most important pathogen in this genus. In burn patients, water from hydrotherapy baths is usually the source of this pathogen; in respiratory infections, the usual source is respiratory therapy equipment. Other types of infections caused by *P. aeruginosa* are folliculitis acquired in swimming pools and hot tubs, swimmer's ear associated with aquatic sports, eye infections due to trauma to the cornea, osteomyelitis due to puncture wounds of the foot, and endocarditis in intravenous-drug users. Mucoid strains of *P. aeruginosa* cause chronic infections in a high percentage of cystic fibrosis (CF) patients. Immunocompetent individuals

are resistant to serious *Pseudomonas* infections. However, immunocompromised hosts, especially CF patients, are occasionally infected with *Pseudomonas* spp. other than *P. aeruginosa*.

Pseudomonas spp. are aerobic, non-spore-forming, Gram-negative bacilli, measuring 0.5 to 1 μm by 2 to 7 μm . The bacilli are longer and thinner than the *Enterobacteriales* but have an appearance similar to that of other nonfermenters. Microscopically mucoid strains, frequently found in CF patients, tend to cluster or produce filaments of short, Gram-negative bacilli surrounded by darker pink material (alginate). Observation of these morphologies intracellularly in polymorphonuclear leukocytes is clinically significant and should be documented.

Pseudomonas spp. grow well on blood and MacConkey agars and are catalase positive, motile by means of one or more polar flagella(e), and oxidase positive. However, exceptions to the oxidase-positive species are *P. luteola* and *P. oryzae*, which are oxidase negative. Most species oxidize glucose and reduce nitrate to either nitrite or nitrogen gas. Six species—*P. aeruginosa*, *P. fluorescens*, *P. monteilii*, *P. mosselii*, *P. putida*, and *P. veronii*—produce a water-soluble, yellow-green or yellow-brown pigment known as pyoverdine. As a result of this pigment, these six species are classified as members of the fluorescent pseudomonad group. Additionally, *P. aeruginosa* also produces a blue-green pigment, pyocyanin, which combines with pyoverdine, resulting in a bright green color. Occasional strains of *P. aeruginosa* produce only pyoverdine, making it

difficult to differentiate those strains from the other five fluorescent pseudomonads. *P. aeruginosa* can also produce other diffusible pigments, e.g., pyomelanin (brown black) and pyorubin (red). However, *P. aeruginosa* grows at 42°C, whereas the other fluorescent pseudomonads do not. *P. luteola*, *P. mendocina*, and *P. pseudoalcaligenes* also grow at 42°C. *P. stutzeri*, a frequent isolate but an unusual cause of infection, is easily recognized by its characteristic growth on blood and chocolate agars. *P. stutzeri* colonies are dry and wrinkled and can pit the agar. The differentiating characteristics of the *Pseudomonas* spp. encountered in clinical specimens are presented in Table 16-1. A number of identification systems accurately identify glucose-nonfermenting, Gram-negative bacilli, including the *Pseudomonas* spp.

Although *Pseudomonas* spp. grow on routine culture media, more rapid nucleic acid detection methods have been used for certain situations, e.g., evaluating sputum from CF patients and screening environmental niches. The reason is that commercial identification systems perform poorly, especially with mucoid *P. aeruginosa* isolates. Also, isolates from sites of chronic infection,

e.g., CF respiratory sites, exhibit multiple morphotypes that can make identification difficult. PCR amplification has been valuable in the identification of *Pseudomonas* spp. other than *P. aeruginosa* as well as biochemically inactive *Pseudomonas* spp. Peptide nucleic acid fluorescent *in situ* hybridization (PNA FISH) has been described as a sensitive and specific assay for the identification of *P. aeruginosa*. Also, identification of these organisms has been improved by the use of matrix-assisted laser desorption ionization-time of flight mass spectrometry (MALDI-TOF MS) technology. *P. aeruginosa* possesses intrinsic resistance to various antimicrobial agents due to the interplay among multiple mechanisms (expression of AmpC, drug efflux pumps, and low permeability of the outer membrane). Additionally, *P. aeruginosa* has the ability to rapidly acquire resistance to multiple classes of antibiotic during the treatment course. Acquired mechanisms include but are not limited to active efflux pumps, porin mutation, production of beta-lactamases (derepression of AmpC, extended-spectrum beta-lactamases, and carbapenemases), impermeability mutation, and target enzyme modification (DNA gyrase).

Table 16-1 Differentiating characteristics of *Pseudomonas* spp. encountered in clinical specimens^a

Species	Oxidase	Growth at 42°C	Nitrate		Gelatin hydrolysis at 7 days	ADH	Glucose	Xylose	Maltose
			NO ₂ ^b	N ₂ ^c					
<i>P. aeruginosa</i>	+	+	+	+	V	+	+	+	0
<i>P. alcaligenes</i>	+	V	V		0	V	0	0	0
<i>P. fluorescens</i>	+	0	V		+	+	+	+	0
<i>P. luteola</i>	0	+	V		V	+	+	+	+
<i>P. mendocina</i>	+	+		+	0	+	+	V	0
<i>P. monteilii</i>	+	0	0		0	0	+	0	0
<i>P. mosselii</i>	+	0	0		+	+	+	0	V
<i>P. oryzae</i>	0	V	0		V	V	+	+	+
<i>P. pseudoalcaligenes</i>	+	+	+		0	V	0	V	0
<i>P. putida</i>	+	0	0		0	+	+	+	V
<i>P. stutzeri</i>	+	V		+	0	0	+	+	+
<i>P. veronii</i>	+	0		+	V	+	+	+	ND

^aADH, arginine dihydrolase; +, positive reaction (≥90% positive); V, variable reaction (11 to 89% positive); 0, negative reaction (≤10% positive); ND, no data.

^bReduces nitrate to nitrite.

^cReduces nitrate to nitrogen gas.

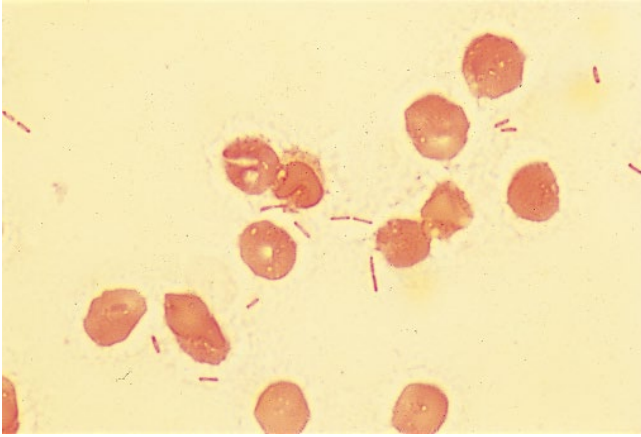


Figure 16-1 Gram stain of *Pseudomonas aeruginosa* grown in blood culture broth. A Gram stain of a blood culture shows slender, Gram-negative bacilli, measuring approximately 1 μm by 5 to 7 μm , with rounded ends. *P. aeruginosa* was isolated from this blood culture.

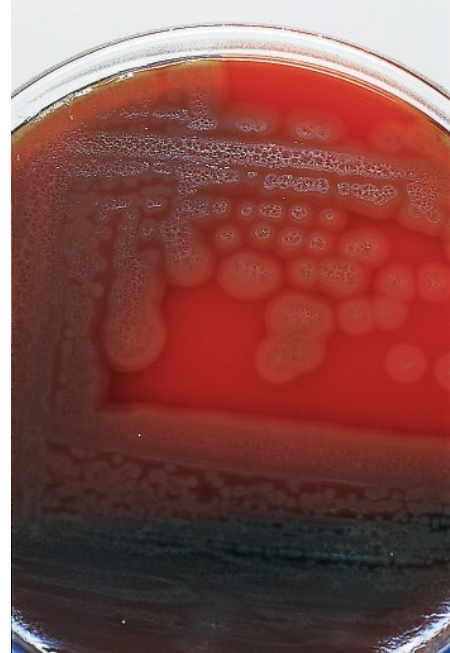


Figure 16-2 *Pseudomonas aeruginosa* on blood agar. Colonies of *P. aeruginosa* are approximately 4 mm in diameter with a blue-green color produced by pyoverdinin and pyocyanin pigments. The colonies are beta-hemolytic, flat, and spreading, with serrated edges and confluent growth. Most isolates have a grape-like odor due to aminoacetophenone.



Figure 16-3 *Pseudomonas aeruginosa* on MacConkey agar. Colonies of *P. aeruginosa* on MacConkey agar are approximately 2 mm in diameter and lactose nonfermenting, with a brownish green coloration and irregular, feathered edges.

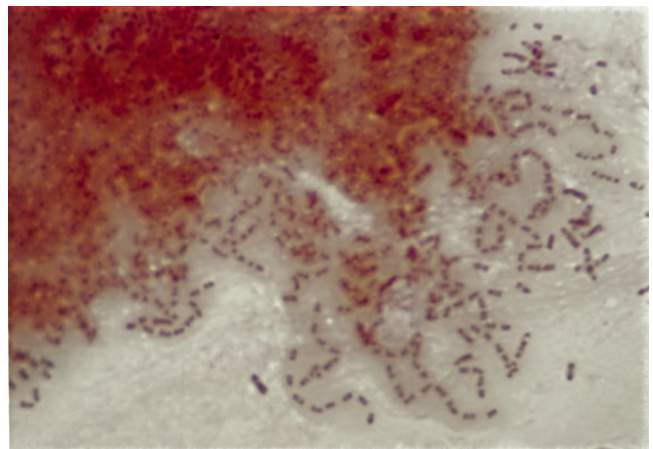


Figure 16-4 Gram stain of mucoid *Pseudomonas aeruginosa*. This image shows a Gram stain of *P. aeruginosa* from a sputum specimen of a CF patient. The Gram-negative bacilli are surrounded by a distinctive orange alginate material, a characteristic finding, since mucoid strains synthesize a large quantity of alginate exopolysaccharide. This alginate material causes the organism to resist phagocytosis and destruction by antimicrobials. (Courtesy of Long Beach Memorial/Healthtech Laboratories, Long Beach, CA.)



Figure 16-5 Mucoid colonies of *Pseudomonas aeruginosa* on blood agar. This figure shows a highly mucoid, nonpigmented strain of *P. aeruginosa*. This is the typical appearance of isolates recovered from respiratory secretions of patients with CF. The colonies are approximately 2 to 3 mm in diameter and are usually smaller than those of the typical pigmented strains shown in Fig. 16-2.

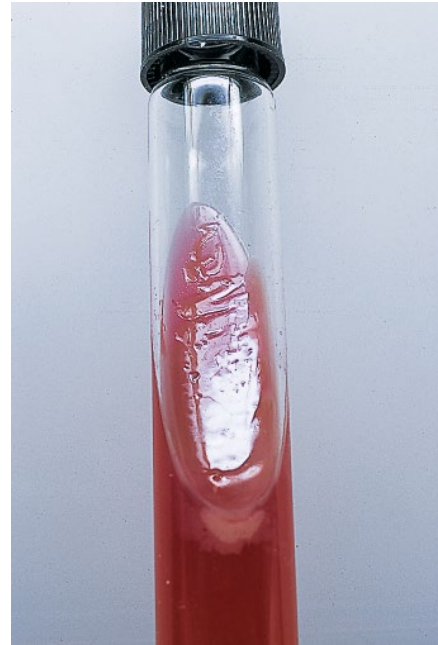


Figure 16-6 *Pseudomonas aeruginosa* on a triple sugar iron agar slant. On a triple sugar iron agar slant, *P. aeruginosa* appears as a blue-green, somewhat metallic layer of growth with greenish fluorescence.



Figure 16-7 *Pseudomonas aeruginosa* on Mueller-Hinton agar. The very distinct green pigment of *P. aeruginosa* colonies is clearly demonstrated when the isolate is grown on a medium without blood, dyes, or other indicators. The fluorescent group of *Pseudomonas* spp. produces pyoverdinin, a water-soluble yellow-green pigment (left). Many strains of *P. aeruginosa* also produce the blue-green water-soluble phenazine pigment pyocyanin (right).



Figure 16-8 *Pseudomonas stutzeri* on blood agar. Colonies of *P. stutzeri* on blood agar have a characteristic dry, wrinkled appearance. They vary in size from approximately 1 to 6 mm in diameter. In areas where there are fewer colonies, the colonies are larger than in areas where there are many.



Figure 16-9 *Pseudomonas stutzeri* in 6.5% NaCl broth. *P. stutzeri*, along with *P. mendocina* and CDC group Vb-3 (*P. stutzeri* biovar), can grow in the presence of 6.5% NaCl. This biochemical characteristic, along with the ability to reduce nitrates to nitrogen gas, the ability to oxidize glucose but not lactose, and its distinctive dry, wrinkled colony morphology, distinguishes the *P. stutzeri* group from the other *Pseudomonas* spp.

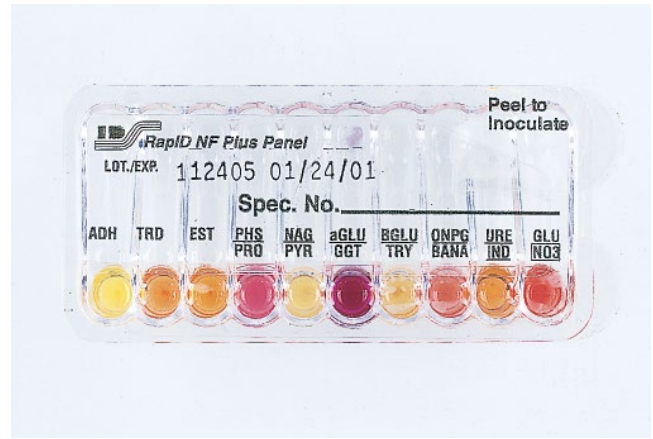


Figure 16-10 *Pseudomonas stutzeri* identified by the RapID NF Plus system. The RapID NF Plus system (Thermo Scientific, Remel Products, Lenexa, KS) is a 4-h test system for the identification of glucose-nonfermenting, Gram-negative bacilli. It contains 10 reaction wells that, along with the oxidase reaction, provide 18 test scores. Wells 4 through 10 are bifunctional, with two separate tests in the same well. The results from the 10 wells are interpreted before the addition of reagents. Reagents are then added, and the additional tests are interpreted. In this example, the positive reactions are proline- β -naphthylamide (PRO), γ -glutamyl- β -naphthylamide (GGT), *N*-benzoylarginine- β -naphthylamide (BANA), and nitrate (NO_3). The oxidase test was also positive. The combination of these test reactions confirms the identification of *P. stutzeri*.



Figure 16-11 *Pseudomonas fluorescens* incubated with gelatin strips. *P. fluorescens* can be differentiated from most of the other *Pseudomonas* spp. because it hydrolyzes gelatin. Some strains of *P. aeruginosa* can also hydrolyze gelatin, although unlike *P. fluorescens*, they grow at 42°C and reduce nitrate to N_2 .

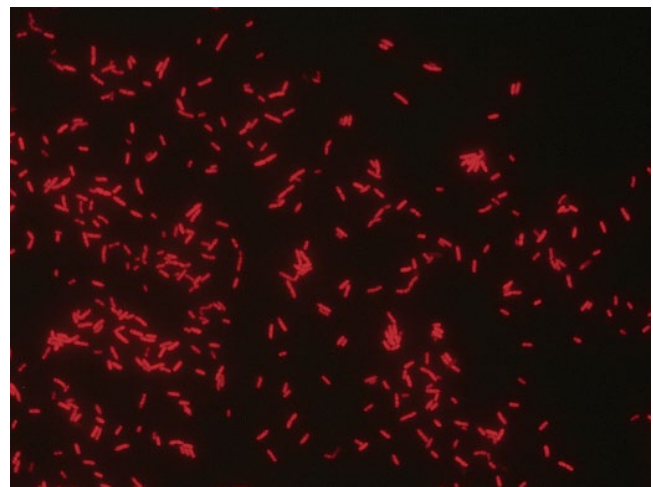


Figure 16-12 *Pseudomonas aeruginosa* identified by PNA FISH. PNA FISH (AdvanDx, Woburn, MA) is a rapid and highly sensitive and specific fluorescent assay for the detection of Gram-negative pathogens, including *P. aeruginosa*. The specimen is placed on a slide and fixed. After fixation, a drop of the probe solution is added and hybridized. The slide is washed and read using a fluorescent microscope. The red color signifies hybridization with *P. aeruginosa*. (Courtesy of AdvanDx.)

Burkholderia, *Stenotrophomonas*, *Ralstonia*, *Cupriavidus*, *Pandoraea*, *Brevundimonas*, *Comamonas*, *Delftia*, and *Acidovorax*

17

Several species previously in the genus *Pseudomonas* have been reclassified into several new genera as a result of DNA-rRNA hybridization experiments. These genera include *Burkholderia*, *Stenotrophomonas*, *Ralstonia*, *Cupriavidus*, *Pandoraea*, *Brevundimonas*, *Comamonas*, *Delftia*, and *Acidovorax*.

Pseudomonas spp., discussed in chapter 16, belong to rRNA homology group I. rRNA homology group II includes four genera: *Burkholderia*, *Ralstonia*, *Cupriavidus*, and *Pandoraea*. The genus *Burkholderia* comprises >100 species. The species known to cause a majority of human *Burkholderia* infections are *Burkholderia cepacia* complex (20 species), *Burkholderia gladioli*, *Burkholderia mallei*, and *Burkholderia pseudomallei*. *Burkholderia glumae* and *Burkholderia thailandensis* are uncommon causes of infection. The human pathogens within the genus *Ralstonia* include *Ralstonia pickettii*, *Ralstonia mannitolilytica*, and *Ralstonia insidiosa*. The genus *Cupriavidus* consists of four species known to cause infections in humans: *Cupriavidus pauculus*, *Cupriavidus gilardii*, *Cupriavidus respiraculi*, and *Cupriavidus taiwanensis*. The genus *Pandoraea* was created for species previously classified in the genera *Burkholderia* and *Ralstonia*. There are five distinct species and several unnamed ones, most occurring in clinical specimens. The named species include *Pandoraea apista*, *Pandoraea pulmonicola*, *Pandoraea pnomenus*, *Pandoraea sputorum*, and *Pandoraea norimbergensis*.

Organisms previously classified in *Pseudomonas* rRNA homology group III have been reclassified into the family *Comamonadaceae*, which includes the genera *Comamonas*,

Delftia, and *Acidovorax*. Human clinical isolates in the genus *Comamonas* are *Comamonas terrigena*, *Comamonas aquatica*, and *Comamonas kerstersii*. *Comamonas acidovorans* has been reclassified as *Delftia acidovorans*. The genus *Acidovorax* comprises *Acidovorax delafieldii*, *Acidovorax temperans*, and *Acidovorax wautersii*, along with five other plant and environmental species.

The genus *Brevundimonas* was previously classified as *Pseudomonas* rRNA homology group IV. There are 14 species, most of which are environmental, with the exception of *Brevundimonas diminuta*, *Brevundimonas vesicularis*, and *Brevundimonas vancouverii*. *Pseudomonas maltophilia* was originally in *Pseudomonas* rRNA homology group V. It was transferred to the genus *Xanthomonas* and finally to the genus *Stenotrophomonas*. There are eight species of *Stenotrophomonas*, and all but *Stenotrophomonas maltophilia* are environmental species.

The nine genera discussed in this chapter are opportunistic pathogens isolated primarily from patients in health care settings. Many of these organisms cause infections in patients with cystic fibrosis (CF). For example, the 20 species of the *B. cepacia* complex have been isolated from CF patients. In the United States, *Burkholderia multivorans* and *Burkholderia cenocepacia* account for a majority of these infections. Outbreaks of *Burkholderia* infections can usually be traced to contaminated equipment or aqueous solutions, due to the organisms' ability to survive in those environments. Patients with chronic granulomatous disease and with CF are more susceptible to infection. These organisms have been isolated from a variety of sources, including

pharmaceutical preparations, unpasteurized dairy products, and bottled water.

B. mallei, which causes glanders in horses, mules, and donkeys, can also be transmitted to humans, although it is extremely rare to isolate in clinical specimens. *B. mallei* has been identified as a potential agent of bioterrorism, and therefore, if it is suspected, the sample should be processed using biosafety level 2 practices.

B. pseudomallei is the cause of melioidosis, a disease prevalent in Southeast Asia and northern Australia, especially during the monsoon seasons. Melioidosis is becoming more common in Europe and the United States due to travel to those locations, especially for individuals with CF. The organism infects humans by inhalation or through contact with broken skin, and there is a high mortality rate in patients with sepsis. Chronic infections can mimic *Mycobacterium tuberculosis* infection because *B. pseudomallei* can produce granulomatous lesions in tissue. The sources of infection are usually contaminated respiratory therapy equipment and disinfectants. *B. gladioli*, previously considered a plant pathogen, has also been isolated from the sputa of patients with CF as well as those with chronic granulomatous disease.

S. maltophilia, a health care-related pathogen, can cause a wide variety of serious disseminated infections in immunocompromised patients whose respiratory tracts are colonized with this organism. It has become one of the most common species isolated in intensive care units, especially from patients requiring ventilators. The incidence of *S. maltophilia* in CF patients has been increasing. *S. maltophilia* also causes wound infections related to trauma associated with the use of agricultural equipment. Several other types of infections have been described, including bacteremia, endocarditis, meningitis, pneumonia, and urinary tract infections. *S. maltophilia*, an opportunistic pathogen, usually does not cause infections in healthy individuals.

R. pickettii has been isolated from a variety of clinical specimens and can cause bacteremia, meningitis, endocarditis, and osteomyelitis. Although it has been isolated from the respiratory tracts of CF patients, it does not appear to cause pulmonary disease. It has also been identified in pseudobacteremia and outbreaks of health care-related disease due to contaminated intravenous medications, “sterile” solutions, and intravenous catheters. *R. mannitolilytica* accounts for a majority of *Ralstonia* infections in CF patients and twice as many as *R. pickettii*. *R. insidiosa* and *C. respiraculi* have also been implicated in human infections, including those in patients with CF. *C. gilardii* has been isolated from

cerebrospinal fluid, and *C. pauculus* is reported to cause bacteremia, peritonitis, and tenosynovitis. Both organisms have been recovered from the sputum of CF patients. The three species of *Brevundimonas*, *B. diminuta*, *B. vesicularis*, and *B. vancanneytii*, are occasionally isolated from clinical specimens and can produce bacteremia in patients with various underlying diseases, including cancer. *D. acidovorans* and *Comamonas testosteroni* have been associated with infections in humans and have been recovered from the sputa of patients with CF. *D. acidovorans* can cause bacteremia, endocarditis, and infections of the eye and ear. *C. testosteroni* has been isolated from the peritoneal cavity. *Acidovorax* spp., *D. acidovorans*, and *C. testosteroni* have been recovered from sputa of CF patients; however, the roles of these organisms in contributing to lung disease in CF need to be established. *Pandoraea* spp. also cause infections in CF patients and patients with chronic obstructive pulmonary disease.

By Gram staining, these genera appear as straight or slightly curved, Gram-negative bacilli, measuring 0.5 to 1.0 μm by 1.8 to 5 μm , with the exception of *Stenotrophomonas* spp., which appear as straight bacilli and may be slightly smaller than the other genera. On Gram stains prepared from specimens obtained from CF patients infected with *B. cepacia*, the Gram-negative bacilli are surrounded by large capsules. These genera are motile by means of polar flagella, with the exception of *B. mallei*, which is nonmotile. Additionally, *B. pseudomallei* may appear as small, Gram-negative bacilli with bipolar staining. Most of these organisms grow on routine laboratory media, are nonfermenters, oxidize glucose, and reduce nitrate. They are catalase positive, and most are weakly or strongly oxidase positive, with the exception of *Stenotrophomonas* spp. and *B. gladioli*.

The organisms discussed in this chapter grow well on enriched primary isolation media, including blood and chocolate agars. With the exception of *B. vesicularis*, these organisms also grow on MacConkey agar. Although most strains of *B. diminuta* grow on MacConkey agar, they also require cysteine for growth. Selective media, such as BC (*Burkholderia* [*Pseudomonas*] *cepacia*) agar, OFPBL (oxidative-fermentative base polymyxin B-bacitracin-lactose) agar (BD Diagnostics, Franklin Lakes, NJ), and BCSA (*B. cepacia* selective agar; Hardy Diagnostics, Santa Maria, CA), can be used to isolate *B. cepacia* complex and *B. pseudomallei*. These media contain antibiotics that inhibit the growth of *P. aeruginosa*, which may be helpful when sputum samples from CF patients are cultured. BCSA is the most sensitive of the three media for the isolation of *B. cepacia*. Ashdown

agar, which contains crystal violet and gentamicin, is a selective medium for the isolation of *B. pseudomallei* from clinical specimens. However, Ashdown broth medium, supplemented with 50 mg of colistin per liter, increases organism recovery by 25% compared with direct plating of clinical specimens on Ashdown agar. *B. cepacia* medium is a good alternative when Ashdown medium is not available. A selective medium containing vancomycin, imipenem, and amphotericin B increases the recovery of *S. maltophilia*.

Colony morphology and pigment production can be helpful in the differentiation of these organisms. For example, *B. vesicularis* produces dark yellow to orange colonies on blood agar after 48 h of incubation at 35°C, whereas *B. diminuta* colonies are chalk white. Some strains of *B. cepacia* complex produce a yellow pigment on some media and a dark pink or red color on MacConkey agar after 4 days of incubation at 35°C. This is due to lactose oxidation after prolonged incubation. *B. gladioli* produces a bright yellow pigment on OFPBL agar and can therefore be confused with *B. cepacia*. *B. cepacia* may also be slow growing when isolated from the sputum samples of CF patients, with at least 3 days of incubation being required before colonies appear

on isolation media; the colonies appear wet, runny, and mucoid. *B. mallei* may be confused with *B. pseudomallei*, although they differ in that *B. mallei* is nonmotile and susceptible to gentamicin while *B. pseudomallei* is motile and resistant to gentamicin. Colonies of *B. pseudomallei* can appear as either smooth and mucoid or dry and wrinkled and resemble *Pseudomonas stutzeri*. Because of the clinical importance of *B. pseudomallei*, it is necessary to distinguish between these two organisms. *Acidovorans* spp. may also produce a yellow pigment, while *B. diminuta*, *C. testosteroni*, and *S. maltophilia* can produce a tan to brown pigment. Colonies of *R. pickettii* are slow growing and pinpoint after 24 h of incubation on blood agar incubated at 35°C.

Several key biochemical tests, including oxidase, nitrate reduction, arginine dihydrolase, gelatinase activity, DNase reaction, and oxidation of carbohydrates, can be used to differentiate these organisms. Conventional biochemicals or identification kits are available. However, the identification kits should be used with caution because of their low level of accuracy with some of these organisms, especially those isolated from CF patients. Key characteristics of the organisms discussed in this chapter are shown in Table 17-1.

Table 17-1 Key characteristics of *Acidovorax*, *Brevundimonas*, *Burkholderia*, *Comamonas*, *Cupriavidus*, *Delftia*, *Pandoraea*, *Ralstonia*, and *Stenotrophomonas* isolates from clinical specimens^a

Organism	Oxidase	Nitrate	LYS	Growth at 42°C	Glucose	Xylose	Lactose	Sucrose	Maltose	Mannitol
<i>Acidovorax</i> spp.	+	+	0	V	+	V	0	0	0	V
<i>Brevundimonas diminuta</i>	+	0	0	V	V	0	0	0	0	0
<i>Brevundimonas vesicularis</i>	+	0	0	V	V	V	0	0	+	0
<i>Burkholderia cepacia</i>	+	0	+	V	+	+	+	V	V	+
<i>Burkholderia gladioli</i>	0	V	0	0	+	+	0	0	0	+
<i>Burkholderia mallei</i>	V	+	0	0	+	V	V	0	0	0
<i>Burkholderia pseudomallei</i>	+	+, gas ^b	0	+	+	+	+	V	+	+
<i>Comamonas testosteroni</i>	+	+ ^c	0	V	0	0	0	0	0	0
<i>Cupriavidus</i> spp.	+	0	0	V	0	0	0	0	ND	ND
<i>Delftia acidovorans</i>	+	+ ^c	0	V	0	0	0	0	0	+
<i>Pandoraea</i> spp.	V	V	0	V	Weak, 0	0	0	0	0	ND
<i>Ralstonia pickettii</i>	+	+, gas ^b	0	V	+	+	V	0	V	0
<i>Ralstonia insidiosa</i>	+	+	0	ND	0	+	V	0	ND	ND
<i>Ralstonia mannitolilytica</i>	+	0	0	+	+	+	+	0	+	+
<i>Stenotrophomonas maltophilia</i>	V	V	+	V	V	V	V	V	+	0

^aLYS, lysine decarboxylase; +, positive reaction (≥90% positive); V, variable reaction (11 to 89% positive); 0, negative reaction (≤10% positive); ND, no data.

^bOrganism reduces nitrate to nitrogen gas.

^cOrganism reduces nitrate to nitrite.

Rapid direct detection methods have been developed for *B. pseudomallei* because of the high mortality rate associated with it. These include urine antigen detection by latex agglutination and enzyme immunoassay. Enzyme immunoassay is more sensitive than latex agglutination; however, results should be interpreted with caution



Figure 17-1 *Burkholderia cepacia* on blood agar. Colonies of *B. cepacia* on blood agar appear smooth, round, opaque, and tan, measuring approximately 2 to 3 mm in diameter. This organism produces diffusible nonfluorescent pigments ranging in color from buff to yellow-tan.

because of cross-reactivity with other urinary tract pathogens. Serologic tests are useful only in individuals who have traveled to areas where *B. pseudomallei* infection is endemic. Several molecular assays are available for the organisms discussed in this chapter. However, they are not sufficiently sensitive to replace conventional culture.

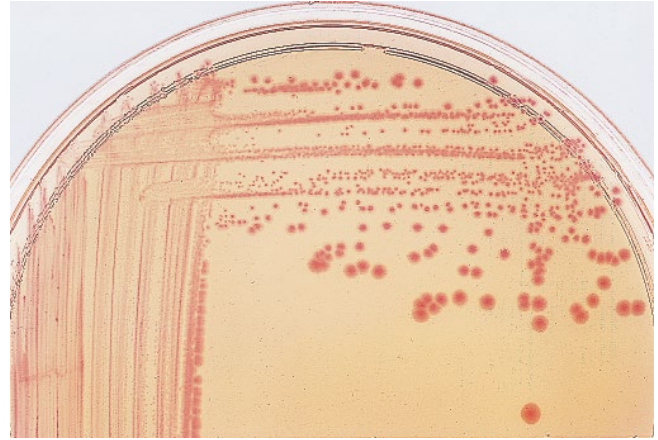


Figure 17-2 *Burkholderia cepacia* on MacConkey agar incubated for 4 days. Colonies of *B. cepacia* on MacConkey agar are bright pink after 4 days of incubation at 35°C, due to oxidation of lactose.

Figure 17-3 *Burkholderia cepacia* on a triple sugar iron (TSI) agar slant. Shown is the typical reaction of *B. cepacia* on a TSI agar slant, an alkaline slant and no change in the butt after overnight incubation. However, if the TSI slant is incubated for 4 to 7 days, both the butt and slant become slightly acid because of the oxidation of glucose, lactose, and sucrose, the three sugars in this medium.





Figure 17-4 *Burkholderia cepacia* identified by the RapID NF Plus system. The RapID NF Plus system (Thermo Scientific, Remel Products, Lenexa, KS) is used for the identification of glucose-nonfermenting and selected glucose-fermenting, Gram-negative bacteria not belonging to the family *Enterobacteriales*. A suspension of the test organism is used as the inoculum, which rehydrates and initiates test reactions. After 4 h of incubation of the panel, each test cavity is examined for reactivity by noting the development of a color. In this image, the panel at the top contains the reactions for *B. cepacia* prior to the addition of reagents. The positive reactions are shown in wells 3, 4, and 5: triglyceride (EST; yellow color), *p*-nitrophenylphosphoester (PHS; yellow color), and *p*-nitrophenyl-*N*-acetyl- β -D-glucosaminide (NAG; yellow color), respectively. Following the addition of reagents to wells 4 through 10, the positive reaction is shown in the bottom panel in well 6: γ -glutamyl- β -naphthylamide (GGT; dark pink).



Figure 17-5 *Stenotrophomonas maltophilia* on blood agar. Colonies of *S. maltophilia* are round, opaque, smooth, and nonhemolytic, with a greenish hue, and measure approximately 3 mm in diameter. They can also produce a strong ammonia odor.

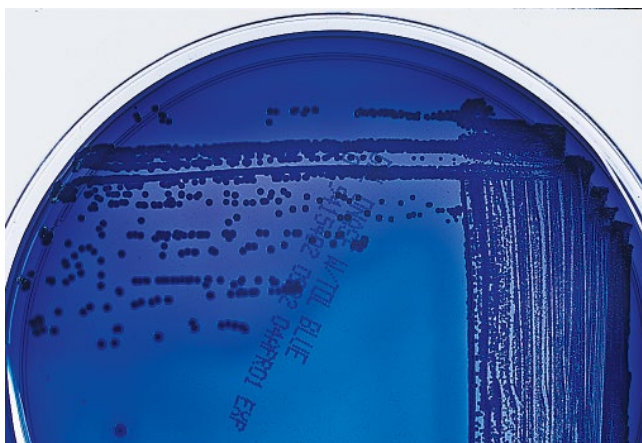


Figure 17-6 *Stenotrophomonas maltophilia* on DNase agar. Colonies of *S. maltophilia* have a positive DNase reaction. Detection of extracellular DNase activity by *S. maltophilia* is key in differentiating this species from most glucose-oxidizing, Gram-negative bacilli. As shown here, DNase-positive organisms produce a zone of clearing around the colonies on this medium.

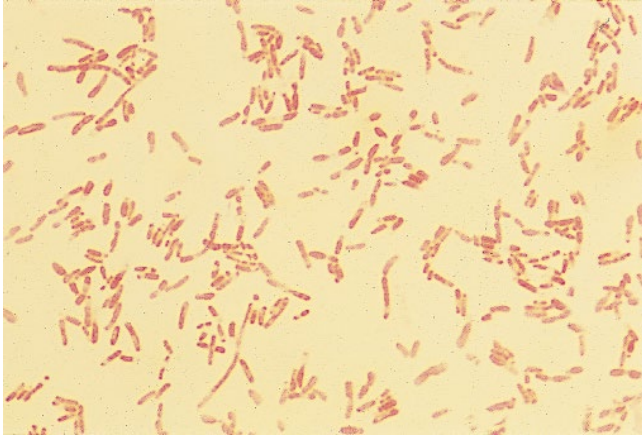


Figure 17-7 Gram stain of *Comamonas* spp. *Comamonas* spp. are straight to slightly curved Gram-negative bacilli, measuring 0.5 to 1.0 μm by 1 to 4 μm and occurring singly and in pairs. Lipid inclusions of poly- β -hydroxybutyrate accumulate in the cells, giving them a moth-eaten appearance.



Figure 17-8 *Comamonas* spp. on blood agar. Colonies of *Comamonas* spp. on blood agar are round and tan, measuring approximately 2 mm in diameter.



Figure 17-9 *Ralstonia pickettii* on blood agar. Colonies of *R. pickettii* after a 48-h incubation at 35°C on blood agar are pinpoint, measuring approximately 1 mm in diameter. This organism is slow growing and may require 72 h to produce visible colonies.



Figure 17-10 Urea and mannitol reactions for *Burkholderia cepacia* and *Ralstonia pickettii*. Because of biochemical similarities, *R. pickettii* may be confused with *B. cepacia*. In this example, the two tubes on the left (mannitol and urea) are positive, suggesting that the organism is *B. cepacia*. Approximately 60% of *B. cepacia* isolates are urea positive and 100% are mannitol positive. In comparison, most strains of *R. pickettii* are urea positive and mannitol negative, as shown in the two tubes on the right.



Figure 17-11 Identification of *Delftia acidovorans* by the RapID NF Plus system. Shown here are positive reactions for triglyceride (EST; yellow-orange) (top) and pyrrolidine- β -naphthylamide (PYR; dark pink), γ -glutamyl- β -naphthylamide (GGT; dark pink), and sodium nitrate (NO_3 ; red) (bottom). These reactions confirm the identification of *D. acidovorans*. Although the indole (IND) reaction might be interpreted as positive due to the reddish orange color, an indole-positive reaction in this system is indicated by a brown or black color.



Figure 17-12 Identification of *Stenotrophomonas maltophilia* by the RapID NF Plus system. *p*-Nitrophenyl-phosphoester (PHS) and *p*-nitrophenyl- β -D-glucoside (β GLU) are positive in the top panel and proline- β -naphthylamide (PRO), γ -glutamyl- β -naphthylamide (GGT), *N*-benzoylarginine- β -naphthylamide (BANA), and sodium nitrate (NO_3) are positive in the bottom panel, confirming the identification of *S. maltophilia*.

Acinetobacter, Chryseobacterium, Moraxella, Methylobacterium, and Other Nonfermentative Gram-Negative Bacilli

18

The organisms described in this chapter form a diverse group of nonfermentative, catalase-positive, Gram-negative bacilli and coccobacilli. They can be divided into five groups based upon oxidase, indole, and trypsin reactions and pigment production (Table 18-1). A majority of these organisms grow at 35°C in an aerobic environment, although some species grow best at <30°C, including the pink-pigmented species. Growth on MacConkey agar varies. Usually it is colorless, although some colonies may be lavender or purple as a result of absorbing crystal violet from the medium. Four genera are considered fastidious, since they grow slowly and poorly on blood agar; *Asaia* spp., *Granulibacter bethesdensis*, *Methylobacterium* spp., and most *Moraxella* spp. Most nonfermenters are found in soil, water (including tap water), and the environment. Clinically, they are considered opportunistic pathogens, with the exception of *Elizabethkingia meningoseptica*, *Elizabethkingia anophelis*, *Moraxella lacunata*, *Moraxella catarrhalis*, and *Acinetobacter calcoaceticus*-*Acinetobacter baumannii* complex.

GROUP I: ACINETOBACTER AND GRANULIBACTER

The organisms in group I are oxidase-negative, Gram-negative, nonfermentative bacteria (GNF).

The genus *Acinetobacter* consists of 51 named species and 11 unnamed species. Of these, 26 are associated with human infections. Most *Acinetobacter* spp. are nonpathogenic, although they can cause infections in immunocompromised patients. Infections affect the

respiratory and urinary tracts, catheter sites, and wounds, and some species cause sepsis in hospitalized patients. Risk factors for infection include the use of respiratory care equipment, antimicrobial therapy, extended stay in an intensive care unit, and surgery. They are the second-most-common nonfermenters isolated from clinical specimens after *Pseudomonas aeruginosa*. The most common clinical isolate is multi-drug-resistant *A. baumannii*, which produces epidemics in hospitals and increased mortality among patients with systemic infections. Two species, *Acinetobacter junii* and *Acinetobacter soli*, have been associated with neonatal outbreaks. *Acinetobacter pittii*, *Acinetobacter nosocomialis*, and *Acinetobacter ursingii* have also been recovered from clinical specimens of hospitalized patients.

On Gram staining, *Acinetobacter* spp. appear as small Gram-negative coccobacilli, measuring 1.0 to 1.5 µm by 1.5 to 2.5 µm, and occur singly and in pairs. Their morphology is very similar to that of *Neisseria* spp. Colonies are smooth, opaque, and grayish white to yellowish on blood agar and are faintly pink on MacConkey agar. They are oxidase-negative, nitrate-negative, nonmotile organisms. *A. baumannii* strains are glucose-oxidizing and nonhemolytic. Identification of most *Acinetobacter* spp. by commercial systems has been problematic. However, with the introduction of matrix-assisted laser desorption ionization-time of flight mass spectrometry (MALDI-TOF MS) rapid, reliable results can be obtained directly from colonies on culture media. Accurate identification of *Acinetobacter* spp. is available by molecular methods, although this approach may not be practical for routine diagnostic laboratories.

Table 18-1 Nonfermentative, Gram-negative bacilli

Oxidase negative	Oxidase positive, indole negative, trypsin negative	Oxidase positive, indole negative, trypsin positive	Oxidase positive, indole positive	Pink pigmented
<i>Acinetobacter</i>	<i>Haematobacter</i>	<i>Alishewanella</i>	<i>Balneatrix</i>	<i>Asaia</i>
<i>Granulibacter</i>	<i>Moraxella</i>	<i>Inquilinus</i>	<i>Bergeyella</i>	<i>Azospirillum</i>
	<i>Oligella</i>	<i>Myroides</i>	<i>Chryseobacterium</i>	<i>Methylobacterium</i>
	<i>Paracoccus</i>	<i>Ochrobactrum</i>	<i>Elizabethkingia</i>	<i>Roseomonas</i>
	<i>Psychrobacter</i>	<i>Pannonibacter</i>	<i>Empedobacter</i>	
	<i>Wohlfahrtiimonas</i>	<i>Pseudochrobactrum</i>	<i>Sphingobacterium mizutaii</i>	
		<i>Rhizobium</i>	<i>Wautersiella</i>	
		<i>Shewanella</i>	<i>Weeksella</i>	
		<i>Sphingobacterium</i>		
		<i>Sphingomonas</i>		

Granulibacter bethesdensis, a fastidious organism, is the other oxidase-negative GNF. On Gram staining, it appears as coccobacillary or rod-shaped. Colonies have a yellow pigment. Although uncommon, it has been isolated from patients with chronic granulomatous disease.

GROUP II: HAEMATOBACTER, MORAXELLA, OLIGELLA, PARACOCUS, PSYCHROBACTER, AND WOHLFAHRTIIMONAS

The organisms in group II are oxidase-positive, indole-negative, trypsin-negative GNF.

Haematobacter spp. have been isolated from patients with septicemia. They are difficult to differentiate from *Psychrobacter phenylpyruvicus* phenotypically and with 16S rRNA methods. Most species are asaccharolytic and phenylalanine, arginine, and urea positive.

There are 20 species of *Moraxella*; however, only four are part of the normal microbiota of the human respiratory tract. They include *M. catarrhalis*, *Moraxella nonliquifaciens*, *Moraxella osloensis*, and *Moraxella lincolnii*. *Moraxella* spp. cause a variety of infections, including arthritis, conjunctivitis, endocarditis, keratitis, meningitis, and septicemia. *M. catarrhalis* is considered a human mucosal pathogen. It has been associated with otitis, sinusitis, and upper and lower respiratory tract infections in adults with chronic obstructive pulmonary disease and immunocompromised patients. If the organism is isolated from sinus

aspirates or the middle ear of children, it should be identified and reported. However, if it is isolated from a throat culture, it should not be reported, since it is considered part of the normal microbiota. *M. lacunata* has been associated with eye infections and infective endocarditis. Other *Moraxella* spp. rarely cause invasive disease.

On Gram staining, *Moraxella* spp. appear as small, plump, Gram-negative coccobacilli that occur in pairs and short chains resembling *Neisseria* spp. Gram stains of specimens obtained from patients with lower respiratory infections, especially with chronic obstructive pulmonary disease, caused by *M. catarrhalis* may reveal many polymorphonuclear leukocytes and intracellular Gram-negative diplococci. On culture, growth is usually pure or predominant. Colonies on blood agar are small, measuring approximately 0.5 mm in diameter after a 24-h incubation and up to 1.0 mm in diameter after a 48-h incubation. Colonies of *M. catarrhalis* are slightly larger than other *Moraxella* spp. and can easily be moved around the plate with a loop (hockey puck sign). Acetazolamide selective medium may be used for isolation. *Moraxella* spp. are strongly oxidase positive, non-motile, indole negative, and asaccharolytic. Most species do not grow on MacConkey agar. Colonies of *M. lacunata* and *M. nonliquifaciens* tend to pit the agar, and *M. nonliquifaciens* may also spread. *M. catarrhalis* and *Moraxella canis* are strongly catalase positive, and most strains reduce nitrate to nitrite. *M. lacunata* is the only proteolytic species with gelatin activity. Tween 80 esterase activity is a rapid test to differentiate it from other *Moraxella* spp.

The genus *Oligella* consists of two species, *Oligella ureolytica* (formerly CDC group IVe) and *Oligella urethralis* (formerly *Moraxella urethralis* and CDC group M-4). Both species cause urosepsis. *O. ureolytica* grows slowly on blood agar, resulting in pinpoint colonies after 24 h; however, large colonies develop after 3 days of incubation. A key characteristic of this organism is that it hydrolyzes urea within a few minutes after inoculation onto a urea-containing medium. *O. urethralis* is similar to *M. osloensis* both in colonial morphology and biochemically. They can be differentiated based on nitrate reduction and phenylalanine deaminase. *O. urethralis* reduces nitrate and has a weakly positive phenylalanine deaminase reaction, while *M. osloensis* is negative for both.

Paracoccus yeei has been reported to cause peritonitis as well as wound and bloodstream infections. On Gram staining, the organisms are Gram-negative cocci and have a doughnut-shaped appearance due to the presence of vacuolated organisms or those that stain peripherally. It is nonmotile; colonies appear pale yellow on blood agar, and it grows on MacConkey agar. It is saccharolytic and urea positive.

The genus *Psychrobacter* includes more than 30 species; however, only a few are of clinical importance. A majority of clinical isolates belong to *P. phenylpyruvicus* (formerly *Moraxella phenylpyruvica*), *Psychrobacter faecalis*, and *Psychrobacter pulmonis*. The latter two species were previously classified as *Psychrobacter immobilis* and are uncommon causes of infection. *P. phenylpyruvicus* has been isolated from blood and cerebrospinal fluid in cases of meningitis. *P. phenylpyruvicus* appears similar to *Moraxella* spp. both microscopically and on culture, except that it is urease and phenylalanine deaminase positive. It grows in 12% NaCl tryptic soy broth supplemented with 0.1% Tween 80. Colonies grown on this medium are at least twice as large as those grown on blood agar. It is phenylalanine deaminase positive. These two characteristics distinguish it from *Psychrobacter sanguinis*, which is similar to *P. phenylpyruvicus*.

Wohlfahrtiimonas chitiniclastica was previously classified as Gilardi rod group 1, known to be closely related. It has been associated with human myiasis, which can result in sepsis. It has been isolated from fly larvae. On Gram staining, it appears as a Gram-negative coccobacillus. It grows on MacConkey agar as flat and slightly spreading colonies. It is phenylalanine deaminase positive.

GROUP III: ALISHEWANELLA, INQUILINUS, MYROIDES, OCHROBACTRUM, PANNONIBACTER, PSEUDOCHROBACTRUM, RHIZOBACTERIUM, SHEWANELLA, SPHINGOMONAS, AND SPHINGOBACTERIUM, INDOLE-NEGATIVE SPECIES

The organisms in group III are oxidase-positive, indole-negative, trypsin-positive GNF. The clinically relevant species are included in the genera *Myroides*, *Ochrobactrum*, *Rhizobium*, *Shewanella*, *Sphingomonas*, and *Sphingobacterium*.

There are 10 species of *Myroides*, but only four have been isolated from clinical specimens: *Myroides phaeus*, *Myroides injenensis*, *Myroides odoratimimus*, and *Myroides odoratus*, although only the latter two are known to cause infections. *M. odoratus* can cause urinary tract infections, although it has been recovered from a variety of other sites and causes septic shock, necrotizing fasciitis, and cellulitis. *M. odoratimimus* was isolated in a health care-related outbreak of urinary tract infections and from soft tissue following a pig bite, and it has caused erysipelas and sepsis.

Myroides spp., formerly classified as *Flavobacterium* spp., are small, Gram-negative bacilli, measuring 0.5 μm by 1.0 to 2.0 μm . Colonies on blood agar have a yellow pigment and tend to spread on the surface of the agar, similar to *Bacillus* spp. They also produce a fruity odor, similar to that of *Alcaligenes faecalis*. *Myroides* spp. grow on MacConkey agar and are oxidase, urease, and gelatinase positive and indole negative. Nitrate is negative, but nitrite is reduced to nitrogen gas. *M. odoratus* and *M. odoratimimus* can be identified by MALDI-TOF MS.

There are 20 species of *Ochrobactrum*, two of which, *Ochrobactrum anthropi* and *Ochrobactrum intermedium*, have been isolated from humans. *O. anthropi* is known to cause catheter-related bacteremia. These two species may be differentiated in that *O. anthropi* does not grow at 41°C and is susceptible to colistin, whereas *O. intermedium* grows at 41°C and is resistant to colistin.

Rhizobium includes two clinically relevant species, *Rhizobium radiobacter* and *Rhizobium pusense*. Although uncommon, they have been isolated most frequently from blood, and the source is usually

contaminated indwelling catheters or implanted prostheses, ascitic fluid, peritoneal dialysate, urine, or airways of patients with cystic fibrosis. Infections include endocarditis and keratitis.

On Gram staining, they appear as small to medium-size, Gram-negative bacilli, measuring 0.6 to 1.0 μm by 1.5 to 3.0 μm . They grow on routine laboratory media at 35°C aerobically, but optimal growth occurs at 25 to 28°C. After a 48-h incubation, colonies on blood agar are approximately 2 mm in diameter, round, smooth, and nonpigmented to buff colored. Colonies may appear pink on MacConkey agar and can become mucoid after prolonged incubation. *Rhizobium* spp. are motile, and the reactions for urease, phenylalanine deaminase, and esculin are positive. They also oxidize glucose, maltose, sucrose, mannitol, and xylose. These reactions distinguish *R. radiobacter* and *R. pusense* from other, closely related organisms. Because of the phenotypic similarities between these two species, isolates of *R. radiobacter* may have been misidentified as *R. pusense*. However, they may be distinguished by sequencing of 16S rRNA and *atpD* genes.

The genus *Shewanella* includes two species, *Shewanella putrefaciens* (formerly *Pseudomonas putrefaciens*, *Alteromonas putrefaciens*, *Achromobacter putrefaciens*, and CDC group Ib) and *Shewanella algae*. *S. algae* is the most common human isolate. The two species have been isolated from a wide variety of clinical specimens and are associated with several types of infections. *Shewanella* spp. are oxidase-positive, indole-negative, Gram-negative bacilli that are motile with a single polar flagellum. On Gram staining, their size varies from short to long and filamentous. Colonies on blood agar are round, smooth, and occasionally mucoid, measuring approximately 2 to 3 mm in diameter, with a brown to tan pigment and greenish discoloration of the medium. *Shewanella* spp. are nitrate, alkaline phosphatase, trypsin, and ornithine decarboxylase positive. A distinguishing characteristic is the production of H_2S in either Kligler iron or triple sugar iron (TSI) agar slants. *S. algae* is very similar to *S. putrefaciens*, except that it is halophilic, requiring NaCl for growth, and does not oxidize maltose or sucrose.

Sphingomonas paucimobilis and *Sphingomonas para-paucimobilis* are the two clinically significant species in the genus *Sphingomonas*. However, at least 12 species have been identified. They are widely distributed in nature, including the hospital environment, and have been isolated from a variety of clinical specimens. On Gram stain, the organisms are long, slender, Gram-negative bacilli, resembling *Pseudomonas* spp. They are motile by means of polar flagella at 18 to 22°C but nonmotile at 37°C. Colonies on blood agar are approximately 2 mm in diameter and

produce a strong yellow pigment when incubated at 30°C. They are oxidase, *o*-nitrophenyl- β -D-galactopyranoside (ONPG), and esculin positive and oxidize glucose, maltose, sucrose, and xylose. Since the two species are difficult to distinguish biochemically, it is recommended that they be reported as *Sphingomonas* spp.

The genus *Sphingobacterium* consists of six species that have been isolated from clinical specimens: *Sphingobacterium cellulitidis*, *Sphingobacterium hotanense*, *Sphingobacterium mizutaii*, *Sphingobacterium multivorum*, *Sphingobacterium spiritivorum*, and *Sphingobacterium thalophilum*. However, *S. multivorum* is the most common species infecting humans. It has been isolated from a variety of clinical specimens, including blood and urine and, although rare, has been associated with necrotizing fasciitis, end-stage renal disease, peritonitis, and sepsis. *Sphingobacterium* spp. are nonmotile, Gram-negative bacilli that produce yellowish colonies. They are indole negative and urease positive and oxidize glucose and xylose; however, only *S. spiritivorum* oxidizes mannitol. Unlike other *Sphingobacterium* spp., *S. thalophilum* reduces nitrate and grows at 41°C.

GROUP IV: BALNEATRIX, BERGEYELLA, CHRYSEOBACTERIUM, ELIZABETHKINGIA, EMPEDOBACTER, SPHINGOBACTERIUM MIZUTAI, WAUTERSIELLA, AND WEEKSELLA

The organisms in group IV are oxidase-positive, indole-positive GNF. Of these, *Chryseobacterium* and *Elizabethkingia* are the most commonly encountered in clinical specimens.

There are over 100 species of *Chryseobacterium*; however, only four named species have been isolated from clinical specimens: *Chryseobacterium indologenes* and *Chryseobacterium gleum* (both formerly CDC group IIb), *Chryseobacterium anthropi* (formerly CDC group IIe), and *Chryseobacterium hominis* (formerly CDC group IIc). *C. indologenes* is the most common species isolated from clinical specimens, including ventilator-associated pneumonia, catheter-associated infection, and neonatal meningitis; a multi-drug-resistant strain was isolated from a cystic fibrosis patient. *C. hominis* is usually isolated from blood, while the other species have been recovered from a variety of specimens, although their clinical significance is minimal or has not been established. Microscopically, they

are Gram-negative bacilli that are thinner in the center than at the ends and can also appear as filamentous forms. *Chryseobacterium* spp. are nonmotile and catalase-, oxidase-, and indole-positive organisms. Most strains of *C. indologenes* and *C. gleum* produce flexirubin, a water-soluble pigment, and are esculin and gelatin hydrolysis positive. Colonies of *C. indologenes* are beta-hemolytic after 3 days of incubation at 37°C, and they will not grow on MacConkey agar or at 41°C and are arabinose negative. In contrast, *C. gleum* is alpha-hemolytic and grows at 41°C, and some strains grow on MacConkey agar and are arabinose positive. Colonies of *C. anthropi* are very sticky and are usually nonpigmented but may develop a salmon pinkish color after a few days. Colonies of *C. hominis* are usually mucoid, and some strains produce a pale yellow pigment.

E. meningoseptica, formerly *Chryseobacterium meningosepticum*, has been associated with neonatal meningitis, endocarditis, and a variety of other infections, including health care-related infections associated with dialysis. Colonies are large and either are nonpigmented or produce a pale yellow or salmon pinkish pigment after 2 to 3 days of incubation. *E. meningoseptica* is mannitol, ONPG, gelatin, and esculin positive.

A second emerging pathogen, *E. anophelis*, and not *E. meningoseptica*, has been suggested as the predominant *Elizabethkingia* human pathogen. It is known to cause a variety of infections, including sepsis in adults and children and neonatal meningitis as well as infections in immunocompromised patients. A case of transmission from mother to infant has been reported, as well as outbreaks due to this organism, two of which occurred in the Midwest region of the United States.

E. anophelis is a slightly yellow, nonmotile, non-spore-forming, Gram-negative bacillus. The organism grows well at 30 to 31°C and 37°C, and it does not grow on MacConkey agar. It is oxidase and catalase positive. It is also esculin, indole, and ONPG positive. It can be differentiated from *E. meningoseptica* based on DNase and gelatin reactions. *E. anophelis* is negative for both, while both tests are positive for *E. meningoseptica*.

GROUP V: ASAIA, AZOSPIRILLUM, METHYLOBACTERIUM, AND ROSEOMONAS

The four genera in group V are pink-pigmented GNF.

There are eight species in the genus *Asaia*, of which two are known to cause infections in humans, *Asaia bogorensis* and *Asaia lannensis*. *A. bogorensis* has

been isolated from blood of patients with intravenous-drug abuse and can cause peritonitis during peritoneal dialysis. *A. lannensis* can cause bacteremia in immunosuppressed pediatric patients and those with idiopathic dilated cardiomyopathy awaiting cardiac transplantation.

Asaia spp. are small to medium Gram-negative bacilli. They are motile with polar or lateral flagella. Colonies are pale pink, shiny, and smooth on blood agar, although growth may be scant. They are oxidase, nitrate, and urea negative. The species are strongly saccharolytic, oxidizing glucose, fructose, mannitol, and xylose. They differ from *Methylobacterium* spp. in that the colonies are not dark when exposed to UV light. Also, *Methylobacterium* spp. are oxidase and urea positive.

Azospirillum brasilense (formerly *Roseomonas fauriae*) has been isolated from patients undergoing continual peritoneal dialysis. It is a Gram-negative coccobacillus and is motile with polar flagella. Colonies are pink and mucoid, resembling *Roseomonas* spp. It is oxidase and urea positive and differs from *Roseomonas* spp. in that it does not oxidize fructose.

Methylobacterium spp. are pink nonfermenters, and their name is derived from their ability to utilize methanol as the sole carbon source. *Methylobacterium mesophilicum*, *Methylobacterium extorquens*, and *Methylobacterium zatmanii* are the species found in clinical specimens mainly from health care-related infections, including septicemia and peritoneal dialysis-associated peritonitis. They can be transmitted in tap water, causing health care-related spread, and form biofilms, and they are resistant to high heat and disinfecting agents, which allows them to colonize hospital equipment. *Methylobacterium* spp. are large, vacuolated, pleomorphic, Gram-negative bacilli that stain poorly and may not be easily decolorized. They are motile by means of a single polar flagellum. They are very slow growing, requiring 4 to 5 days before colonies can be visualized. The colonies are dry and appear pink or coral, measuring approximately 1.0 mm in diameter, on agar media. The colonies absorb UV light and therefore appear dark when exposed to UV light. *Methylobacterium* spp. do not grow on MacConkey agar. Optimal growth occurs between 25 and 30°C. These organisms are oxidase positive and hydrolyze urea and starch.

Roseomonas spp., pink-pigmented nonfermenters, include 28 species. The following have been isolated from clinical specimens: *Roseomonas gilardii* subsp. *gilardii*, *Roseomonas gilardii* subsp. *rosea*, *Roseomonas mucosa*, *Roseomonas cervicalis*, *Roseomonas* genomospecies 4,

and *Roseomonas* genomospecies 5. *Roseomonas* spp. affect mainly immunocompromised individuals. Bloodstream infections make up a majority of infections; however, these organisms have also been isolated from wounds, abscesses, and urogenital sites. Microscopically, isolates are plump, nonvacuolated, Gram-negative bacilli, occurring in pairs and short chains. Although they grow on a variety of laboratory media, including

MacConkey agar, optimal growth occurs on Sabouraud agar. Colonies are large, pink, mucoid, and runny, measuring up to 6 mm in diameter. *R. cervicalis* is strongly oxidase positive, whereas the other species are weakly oxidase positive or oxidase negative. They all hydrolyze starch and urea.

Key characteristics of the genera discussed in this chapter are listed in Table 18-2.

Table 18-2 Differentiating characteristics of miscellaneous nonfermentative, Gram-negative bacilli^a

Genus	Oxidase	Nitrate	Pigment	Motility	Growth on MacConkey agar	Indole
<i>Acinetobacter</i>	0	0	0	0	+	0
<i>Asaia</i>	0	0	Pink-yellowish	+	V	NA
<i>Azospirillum</i>	+	+	Pink	+	+	NA
<i>Chryseobacterium</i>	+	V	Yellow	0	V	+
<i>Elizabethkingia</i>	+	+	V	0	+	+
<i>Methylobacterium</i> ^b	Weak, 0	0	Coral pink	+ ^c	0	0
<i>Moraxella</i>	+	V	0	0	Scant, 0	0
<i>Myroides</i>	+	+, gas	Yellow	0	V	0
<i>Ochrobactrum</i>	+	+, gas	0	+	+	0
<i>Oligella</i>	+	+	0	V	V	0
<i>Paracoccus</i>	+	+	Pale yellow	0	+	0
<i>Psychrobacter</i>	+	V	0	0	+	0
<i>Rhizobium</i>	+	V	V, pale yellow	+	+	0
<i>Roseomonas</i> ^d	Weak, 0	0	Pink	+ ^c	+	NA
<i>Shewanella</i>	+	+	Brown-tan	+	+	0
<i>Sphingobacterium</i>	+	0	Yellowish	0	V	0
<i>Sphingomonas</i>	+	0	Yellow	+ ^c	0	0
<i>Wohlfahrtiimonas</i>	+	0	0	0	+	0

^a+, positive reaction (≥90% positive); V, variable reaction (11 to 89% positive); 0, negative reaction (≤10% positive); NA, not available.

^bGrows best on Sabouraud agar.

^cDifficult to demonstrate.

^d*Roseomonas* genomospecies 4 is nitrate positive.

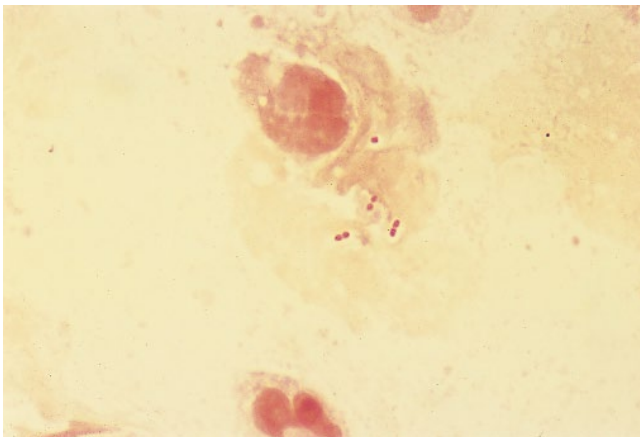


Figure 18-1 Gram stain of *Acinetobacter* spp. Shown is a Gram stain of a sputum specimen containing intracellular, small, Gram-negative coccobacilli, measuring 1.0 by 1.5 μm , occurring singly and in pairs, and resembling *Neisseria* spp. This organism was identified as *A. baumannii*.



Figure 18-2 TSI agar slant inoculated with a nonfermenter. Most nonfermenters grow on the surface of a TSI agar slant, resulting in an alkaline reaction, as shown here. There is no color change in the butt of the medium, because these organisms do not ferment carbohydrates. This is a reaction typical of most nonfermenters on a TSI agar slant.



Figure 18-3 *Acinetobacter baumannii* and *Acinetobacter haemolyticus* on blood agar. After 48 h of growth on blood agar, colonies of *A. baumannii* (left) measure approximately 1.5 mm in diameter and are translucent to opaque, convex, entire, nonhemolytic, and nonpigmented. Colonies of *A. haemolyticus* (right) appear very similar to those of *A. baumannii*; however, they are surrounded by a wide zone of beta-hemolysis.



Figure 18-4 Antimicrobial susceptibility testing of *Acinetobacter* spp. by the disk diffusion method. *Acinetobacter* spp. are resistant to multiple antimicrobial agents. In this example, antimicrobial susceptibility testing of *Acinetobacter* spp. was performed on a Mueller-Hinton agar plate by the disk diffusion method. As expected, this *Acinetobacter* isolate was resistant to the antimicrobials tested.

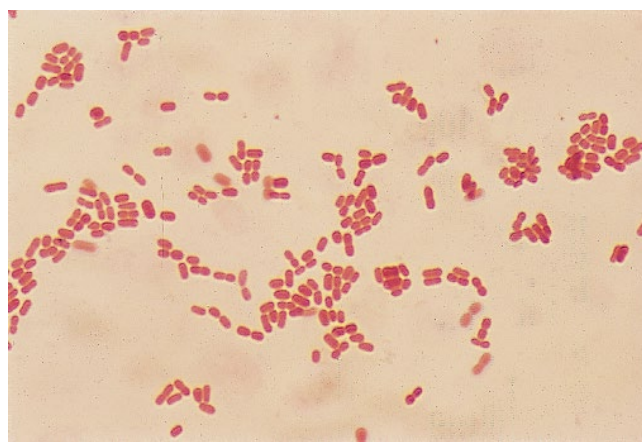


Figure 18-5 Gram stain of *Moraxella* spp. *Moraxella* spp. appear as Gram-negative coccobacilli that occur in pairs and short chains, measuring 1.0 to 1.5 μm by 1.5 to 2.5 μm . Although the organisms in this figure are clearly Gram negative, some strains resist decoloration and appear Gram variable. Cells may be capsulated and pleomorphic when deprived of oxygen.

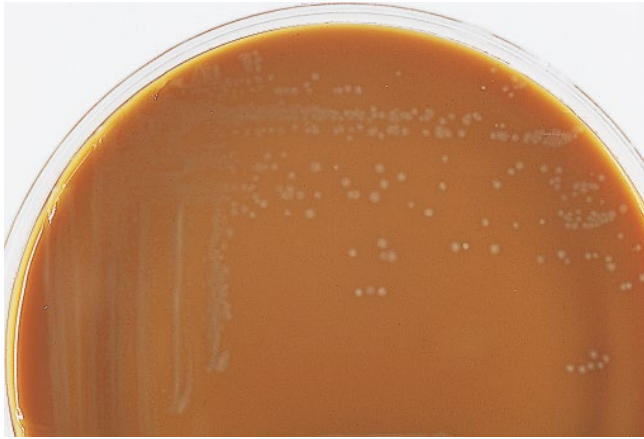


Figure 18-6 *Moraxella lacunata* on chocolate agar incubated for 48 h. Colonies of *M. lacunata* on chocolate agar are small, measuring 0.5 to 1 mm in diameter, and have a greenish hue. Occasionally, these colonies spread and pit the agar after prolonged incubation.

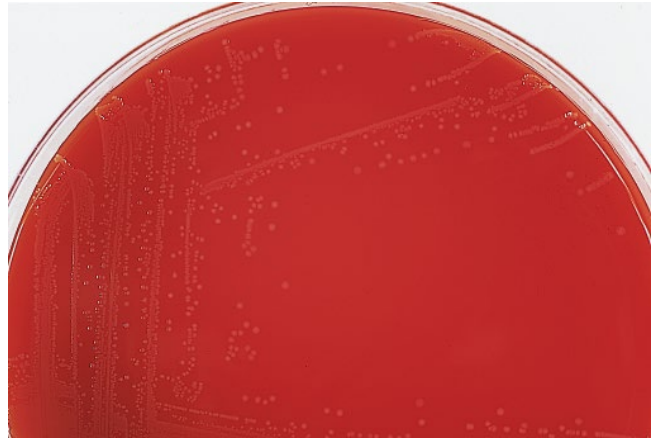


Figure 18-7 *Psychrobacter phenylpyruvicus* on blood agar. Colonies of *P. phenylpyruvicus* on blood agar are small, pinpoint, smooth, translucent, and tan, measuring 0.5 mm in diameter.



Figure 18-8 *Psychrobacter phenylpyruvicus* on a phenylalanine agar slant. The phenylalanine deaminase test is used to determine the ability of an organism to oxidatively deaminate phenylalanine to phenyl pyruvic acid. On addition of a few drops of 10% ferric chloride, a green color is formed between the two compounds. *P. phenylpyruvicus* produces the enzyme phenylalanine deaminase, resulting in a positive test, as shown here. This reaction differentiates *P. phenylpyruvicus* from most other oxidase-positive, indole-negative coccobacillary nonfermenters.



Figure 18-9 *Myroides* spp. (formerly *Flavobacterium* spp.) on blood agar. Colonies of *Myroides* spp. grown on blood agar are small, translucent, smooth, shiny, convex, and circular, measuring 0.5 to 1.0 mm in diameter. The colonies have a slight yellow pigment and tend to spread, as shown in this figure; however, nonpigmented strains do occur. Colonies produce a characteristic fruity odor.

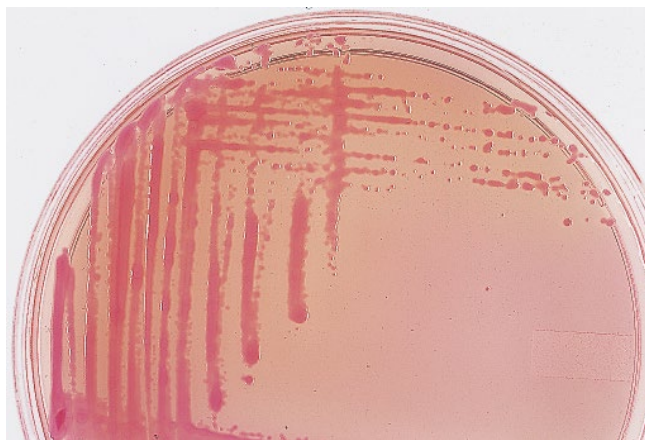


Figure 18-10 *Rhizobium radiobacter* on MacConkey agar. Colonies of *R. radiobacter* on MacConkey agar are small (0.5 to 1.0 mm), convex, circular, smooth, pink, wet, and mucoid after a 48-h incubation at 35°C.



Figure 18-11 *Sphingomonas paucimobilis* on blood agar grown at 30°C. Colonies of *S. paucimobilis* on blood agar are approximately 2 mm in diameter and produce a strong yellow, insoluble, nonfluorescent, carotenoid pigment when incubated at 30°C.

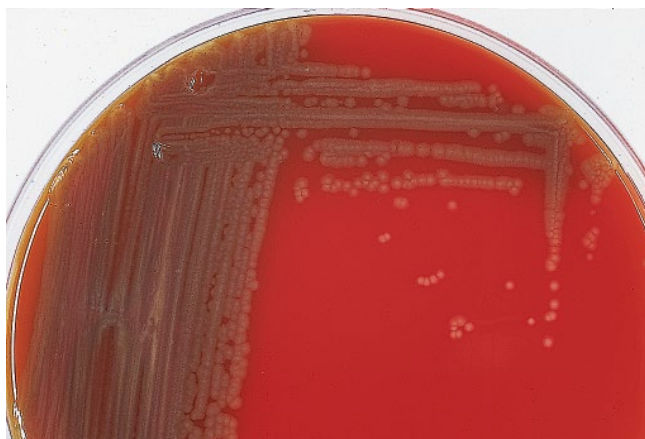


Figure 18-12 *Shewanella putrefaciens* on blood agar. Colonies of *S. putrefaciens* on blood agar are round and smooth, measuring approximately 2 to 3 mm in diameter, with a tan pigment and a greenish discoloration of the medium.



Figure 18-13 *Shewanella putrefaciens* on a TSI agar slant. A distinguishing characteristic of *Shewanella* spp. is the production of H₂S. *S. putrefaciens* is the only non-fermenter that produces large amounts of H₂S on a TSI agar slant (shown here) or on a Kligler iron agar slant.

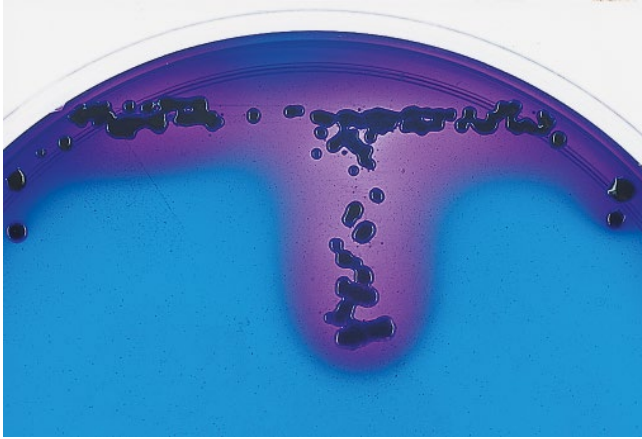


Figure 18-14 *Shewanella putrefaciens* on DNase agar. *S. putrefaciens* produces the enzyme DNase, which hydrolyzes DNA. The DNase test medium contains toluidine blue complexed with DNA. Hydrolysis of DNA causes changes in the structure of the dye to yield a pink color surrounding the colonies.



Figure 18-15 Gram stain of *Methylobacterium* spp. On Gram staining, *Methylobacterium* spp. appear as large, vacuolated, pleomorphic, Gram-negative bacilli, measuring 0.5 to 1.0 μm by 7 to 10 μm , that stain poorly and may not be easily decolorized. The cells contain sudanophilic inclusions and volutin granules, as shown here.

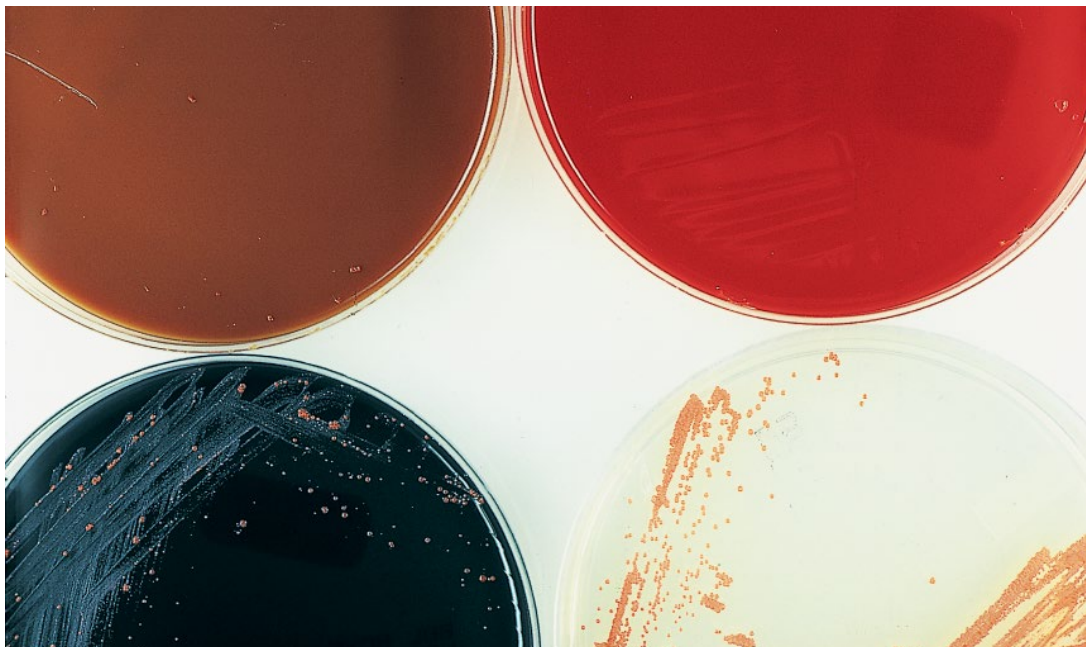


Figure 18-16 *Methylobacterium* spp. on modified Thayer-Martin, blood, Sabouraud, and buffered charcoal-yeast extract agars. Isolates of *Methylobacterium* spp. grow slowly on routine laboratory media, producing 1-mm-diameter coral or pink colonies after incubation for 4 to 5 days. Some strains do not grow on nutrient agar. Here, the organism was inoculated onto modified Thayer-Martin agar (top left), blood agar (top right), Sabouraud agar (bottom right), and buffered charcoal-yeast extract agar (bottom left). The best growth occurred on Sabouraud agar. The optimal temperature for growth of *Methylobacterium* spp. is between 25 and 30°C.

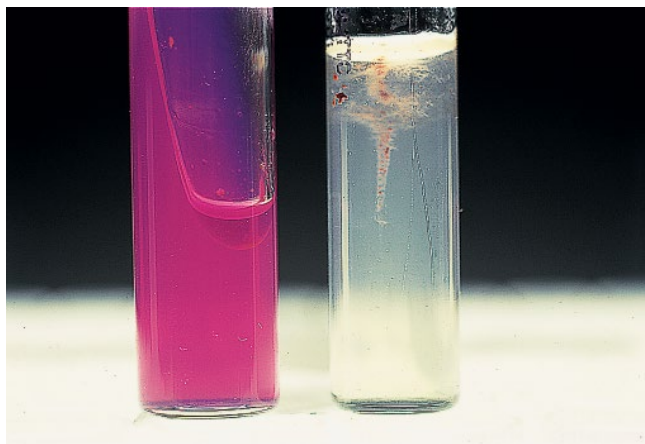


Figure 18-17 *Methylobacterium* spp. on a urea agar slant and in motility medium. *Methylobacterium* spp. are urease positive, causing the urea agar to become bright pink (left tube). They are also motile by means of a single polar or lateral flagellum, although motility is difficult to demonstrate. Here (right tube), the organism appears to be growing away from the stab line in the motility medium, confirming that it is a motile organism.



Figure 18-18 *Roseomonas* spp. on Sabouraud agar incubated at 35°C. Colonies of *Roseomonas* spp. on Sabouraud agar are large, pink, mucoid, and runny and measure approximately 6 mm in diameter. Although they are pink nonfermenters like *Methylobacterium* spp. (Fig. 18-16), their colony morphologies are very different. *Roseomonas* spp. grow on a variety of laboratory media, including MacConkey agar, whereas *Methylobacterium* spp. do not grow on MacConkey agar.



A



B

Figure 18-19 Colonies of *Chryseobacterium indologenes* on blood agar (A) and Mueller-Hinton agar (B). Colonies of *C. indologenes* are deep yellow due to the production of flexirubin.

Actinobacillus, *Aggregatibacter*, *Capnocytophaga*, *Eikenella*, *Kingella*, *Pasteurella*, and Other Fastidious or Rarely Encountered Gram-Negative Bacilli

19

The organisms described in this chapter are termed fastidious because most do not grow well on routine laboratory media; they require special atmospheric conditions and prolonged incubation for growth. They include *Actinobacillus*, *Aggregatibacter*, *Capnocytophaga*, *Cardiobacterium*, *Chromobacterium*, *Dysgonomonas*, *Eikenella*, *Kingella*, *Pasteurella*, *Streptobacillus*, and *Suttonella*. With a few exceptions, these organisms are members of the normal microbiota of the oral cavity and are associated with a variety of human infections. Of note are the four genera in this group, *Aggregatibacter*, *Cardiobacterium*, *Eikenella*, and *Kingella*, which can cause endocarditis, particularly in immunocompromised patients. These four genera belong to the HACEK group of bacteria. The “H” in the acronym HACEK stands for *Haemophilus aphrophilus* and *Haemophilus paraprophilus*, which have now been transferred to the species *Aggregatibacter aphrophilus*.

Microscopically, these Gram-negative bacilli vary in size and shape from coccoid forms to long fusiform bacilli that can be straight or curved. The colony morphology varies on agar media from tiny to large colonies that pit the agar or spread across the agar surface. Most of the HACEK bacteria require 2 to 4 days for growth at 35 to 37°C under either 5 to 10% CO₂ or a microaerophilic atmosphere (candle jar), with increased moisture.

The genus *Actinobacillus* is classified in the family *Pasteurellaceae*. There are two exclusively human pathogens, *Actinobacillus hominis* and *Actinobacillus ureae*, although their normal habitat is unknown. *A. hominis* and *A. ureae* are usually commensal in the human

respiratory tract, especially in patients with lower respiratory tract disease. Cases of meningitis have been reported following surgery or trauma, although it is a rare occurrence, and other infections in immunocompromised patients have been reported. Other *Actinobacillus* spp. also cause infections in humans; however, they are usually associated with animal bites or contact with animals. *Actinobacillus lignieresii* causes actinobacillosis, a granulomatous disease in cattle and sheep similar to actinomycosis, and can cause soft tissue infection in humans. *Actinobacillus equuli* and *Actinobacillus suis* cause infections in humans due to horse and pig bites or contact with these animals. These organisms usually cause disease following trauma or localized injury to otherwise healthy tissue. The most susceptible hosts are immunocompromised and elderly individuals and those with recent viral infections. On Gram stain, *Actinobacillus* spp. appear as small, oval coccobacilli. Most *Actinobacillus* spp. grow on chocolate and blood agars as pinpoint to small colonies, measuring 0.5 to 2 mm in diameter, and are grayish white, adherent, and nonhemolytic, requiring 48 h of incubation before visible growth is detected. They grow best on enriched media at 35 to 37°C in 5 to 10% CO₂. *A. ureae* may show light growth on MacConkey agar, whereas the other species do not grow on this medium. *Actinobacillus* spp. are oxidase positive and reduce nitrate, and some strains produce acid from glucose and maltose and hydrolyze urea. Acid production from carbohydrates is used along with other distinguishing characteristics to differentiate the species. For example, *A. equuli* produces H₂S when a lead acetate

strip is used and is *o*-nitrophenyl- β -D-galactopyranoside (ONPG) positive. *A. suis* hydrolyzes esculin and is also ONPG positive.

The genus *Aggregatibacter* is in the family *Pasteurellaceae*. *Aggregatibacter* includes three species: *Aggregatibacter actinomycetemcomitans*, *Aggregatibacter aphrophilus*, and *Aggregatibacter segnis*. The habitat of *Aggregatibacter* spp. is the human oral cavity, including dental plaque. *A. actinomycetemcomitans* is the most common cause of periodontal disease, a predisposing factor for infective endocarditis following dental manipulations. *A. aphrophilus* may cause systemic disease as well as bone and joint infections. *A. segnis* may also cause endocarditis. *Aggregatibacter* spp. are Gram-negative, coccoid or rod-shaped bacilli and can exhibit filamentous forms. *A. aphrophilus* and *A. segnis* require V factor (nicotinamide) for growth but not hemin (X factor). *A. actinomycetemcomitans* produces small colonies (0.5 to 3 mm in diameter) after 48 to 72 h of incubation on blood agar at 37°C in 5 to 10% CO₂ and, on further incubation, develops a star-like structure and pitting of the agar medium. In liquid media, the colonies form granules that adhere to the sides of the tube. Colonies of *A. aphrophilus* and *A. segnis* are granular to smooth and may be grayish to yellowish. Testing for X and V factors helps to distinguish them from *Haemophilus* spp. They are dependent on the V factor but not the X factor and are indole, ornithine, and urea negative.

There are seven *Capnocytophaga* spp. that cause infections in humans. Five species are members of the normal oral microbiota of humans: *Capnocytophaga gingivalis*, *Capnocytophaga granulosa*, *Capnocytophaga haemolytica*, *Capnocytophaga ochracea*, and *Capnocytophaga sputigena*. These species have been isolated from the oral cavity, including dental pockets, subgingival plaque, respiratory secretions, wounds, and blood. They cause endocarditis, endometritis, ophthalmic lesions, osteomyelitis, septicemia, and soft tissue infections in immunocompetent and immunosuppressed patients, particularly in those with granulocytopenia. Two species, *Capnocytophaga canimorsus* and *Capnocytophaga cynodegmi*, cause infection following dog or cat bites. *C. canimorsus* can cause septicemia with serious sequelae in alcoholics and patients who have had splenectomies. Endocarditis, keratitis, and meningitis have also been reported. Infections with *C. cynodegmi* are rare and may be localized or systemic.

Capnocytophaga spp. are thin, Gram-negative bacilli with pointed ends, resembling *Fusobacterium* spp. They have a characteristic movement described as gliding

motility. On blood and chocolate agars, the organism produces tiny pinpoint, yellow-orange colonies in 24 h when grown at 35 to 37°C under 5 to 10% CO₂ or anaerobically; however, they do not grow aerobically. The colonies pit the agar and spread or swarm due to gliding motility. *Capnocytophaga* spp. isolated from humans are indole, oxidase, and catalase negative, with the exception of *C. canimorsus* and *C. cynodegmi*, which are oxidase and catalase positive. *C. gingivalis* is ONPG negative, while the other species are positive. It is difficult to identify these organisms by phenotypic methods because they are biochemically similar. However, *Capnocytophaga* spp. can be differentiated from one another by matrix-assisted laser desorption ionization-time of flight mass spectrometry (MALDI-TOF MS).

The genus *Cardiobacterium* has two species: *Cardiobacterium hominis* and *Cardiobacterium valvarum*. Both species are pathogenic, causing infective endocarditis. *C. hominis* has also been isolated from other body sites, although rarely. *Cardiobacterium* spp. are Gram-negative bacilli, measuring 1.0 μ m by 2.0 to 4.0 μ m. On Gram staining, they have a characteristic appearance in that they are pleomorphic bacilli with swollen ends arranged in rosette clusters. Colonies grow on blood and chocolate agars as pale yellow to white colonies, measuring 1 mm, after 2 to 4 days of incubation at 37°C in 5 to 10% CO₂ in a humid atmosphere. The colonies may pit the agar. Like other fastidious Gram-negative bacilli, they do not grow on MacConkey agar. *C. valvarum* may be misidentified by some of the automated systems because of the similarity between the two species. However, both species may be correctly identified by MALDI-TOF MS.

The genus *Chromobacterium* contains two species that are pathogenic for humans, *Chromobacterium violaceum* and *Chromobacterium haemolyticum*. The infection site of *C. violaceum* is usually a cutaneous lesion that has become contaminated with soil and water. This organism also causes septicemia, and multiple organ abscesses may follow. A high mortality rate has been reported for disseminated infections, associated with neutrophil dysfunction. *C. haemolyticum* can cause sepsis following trauma and exposure to water.

Microscopic morphology of the two species differs. *C. violaceum* is a coccoid or straight, Gram-negative bacillus, occurring singly and in pairs and short chains. *C. haemolyticum* appears as a straight Gram-negative bacillus. Both species grow on routine laboratory media, including MacConkey agar, at 30 to 35°C. Colonies of *C. violaceum* are smooth and round, measuring 3 mm in diameter, with a deep violet pigment called violacein.

This pigment may interfere with the oxidase reaction. Colonies of *C. haemolyticum* are nonpigmented and beta-hemolytic. *C. violaceum* may be differentiated from *C. haemolyticum* based on its characteristic violet pigment, indole, and mannitol tests. *C. violaceum* is indole variable and mannitol negative, and *C. haemolyticum* is indole negative and mannitol positive.

The genus *Dysgonomonas* belongs to a group of facultative anaerobic, nonmotile, Gram-negative coccobacilli. Four species have been isolated from humans: *Dysgonomonas capnocytophagoideis*, *Dysgonomonas gadei*, *Dysgonomonas mossii*, and *Dysgonomonas hofstadii*. These species have been isolated from feces, blood and other body fluids, gallbladder, and wounds. Isolates are primarily from immunocompromised hosts. Microscopically, they appear as small Gram-negative bacilli or cocci or as long bacilli when grown around a penicillin disk. Colonies grow slowly on blood agar in CO₂ and are 1 to 2 mm in diameter, and some strains produce a sweet odor after 48 to 72 h. They are catalase, nitrate, and oxidase negative and esculin and ONPG positive. *D. capnocytophagoideis*, *D. gadei*, and *D. mossii* produce acid from lactose, sucrose, and xylose. If *Dysgonomonas* spp. are suspected as a cause of diarrhea, a selective medium containing cefoperazone, vancomycin, and amphotericin B blood agar, incubated at 35°C in 5 to 7% CO₂, is recommended for fecal cultures.

The genus *Eikenella*, in the family *Neisseriaceae*, has one species, *Eikenella corrodens*. It has been isolated from the oral cavity, including dental pockets, subgingival plaque, respiratory secretions, wounds, and blood. *E. corrodens* is frequently associated with trauma as a result of human bites. The organism is a thin, Gram-negative bacillus, measuring 0.5 µm by 2 to 4 µm. Growth on agar media occurs after 2 to 4 days of incubation at 35°C to 37°C under 5% CO₂. *E. corrodens* grows well on commercial Columbia agar. The organism requires heme and therefore does not grow on MacConkey agar. Colonies are 0.2 to 0.5 mm in diameter at 24 h and 0.5 to 1.0 mm at 48 h. They appear gray when young but may become pale yellow after prolonged incubation. Most strains form small pits or corrode the surface of the agar and produce a bleach-like odor. In broth medium, the organism adheres to the side of the tube and produces granules. *E. corrodens* is oxidase and ornithine decarboxylase positive and reduces nitrate, but it is catalase negative.

The genus *Kingella* belongs to the family *Neisseriaceae*. There are five species of *Kingella*. *Kingella kingae*, *Kingella oralis*, *Kingella potus*, and *Kingella denitrificans* are all part of the normal microbiota of the respiratory

tract of humans. As mentioned above, *Kingella* spp. are members of the HACEK group, and two species, *K. kingae* and *K. denitrificans*, cause infective endocarditis. Infections caused by *K. kingae*, i.e., osteomyelitis, septic arthritis, and septicemia, are most often found in infants and young children. The fifth species, *K. negevensis*, is a recently described species that is closely related to *K. kingae*. Although most strains have been isolated from the oral cavity of healthy children, it has also been isolated from a patient with vaginosis.

Kingella spp. are small, Gram-negative coccobacilli, measuring 0.5 to 1.0 µm by 2 to 3 µm, occurring in pairs and short chains resembling *Neisseria* spp. *Kingella* spp. grow on blood and chocolate agars after 2 to 4 days of incubation at 35 to 37°C under 5% CO₂. Colonies of *K. kingae* are beta-hemolytic, while the others are not. Inoculation of body fluids into blood culture media has improved recovery of *K. kingae*, since body fluids inoculated directly onto culture media may be inhibitory to the growth of this organism. *Kingella* spp. are oxidase positive and catalase negative. *K. denitrificans* reduces nitrate, but the other *Kingella* spp. do not. *K. kingae* produces acid in both glucose and maltose after prolonged incubation, while the other *Kingella* spp. produce acid in glucose alone, although *K. potus* is glucose negative. *K. denitrificans* may grow on Thayer-Martin medium and may be misidentified as *Neisseria gonorrhoeae*. They differ based on their catalase reaction: *K. denitrificans* is catalase negative and *N. gonorrhoeae* is catalase positive.

There are several species in the genus *Pasteurella*, of which *Pasteurella multocida*, *Pasteurella canis*, *Pasteurella dagmatis*, and *Pasteurella stomatis* can be isolated from humans.

P. multocida is the most common species found in human infections. Currently, there are three subspecies: *Pasteurella multocida* subsp. *multocida*, *P. multocida* subsp. *septica*, and *P. multocida* subsp. *gallicida*. *P. multocida* is a commensal organism in the upper respiratory tracts of mammals and fowl and perhaps also of humans, in particular those with chronic respiratory infections. Infections are frequently associated with animal bites, especially those from cats, and result in cellulitis and lymphadenitis. Although not as common, these organisms can cause respiratory infections, meningitis, dialysis-associated peritonitis, endocarditis, osteomyelitis, urinary tract infection, and bloodstream infections. *P. multocida* subsp. *multocida* is the most frequently encountered subspecies and causes respiratory tract and bloodstream infections, while *P. multocida* subsp. *septica* is usually associated with wound and central nervous system infections. *P. canis* is the most common *Pasteurella* species isolated from dog bite wounds.

P. dagmatis causes systemic infections, including endocarditis, peritonitis, pneumonia, and septicemia.

Microscopically, *Pasteurella* spp. are Gram-negative, pleomorphic coccobacilli or bacilli, occurring singly, in pairs, and in short chains, and often appear bipolar. *Pasteurella* spp. grow on chocolate and blood agars, producing small, gray, smooth, nonhemolytic colonies that may be mucoid if encapsulated. Several species of *Pasteurella*, including *P. multocida*, do not grow on MacConkey agar. Members of the genus *Pasteurella* are facultatively anaerobic and nonmotile. The majority of strains that are clinically significant are catalase, oxidase, alkaline phosphatase, and indole positive. Most of the species produce acid from fructose, galactose, glucose, mannose, and sucrose and reduce nitrates to nitrites.

The genus *Streptobacillus* consists of two species, *Streptobacillus hongkongensis* (a recently described species) and *Streptobacillus moniliformis*. The human oropharynx is a reservoir of *S. hongkongensis*, which has been isolated from patients with septic arthritis. *S. moniliformis* is normally found in the upper respiratory tract of rats and is the cause of streptobacillary rat bite fever. When the organism is acquired by consumption of contaminated food and water, the resulting disease is called Haverhill fever or epidemic arthritic erythema. Complications can result in more serious infections, such as endocarditis, septic arthritis, pneumonia, pancreatitis, and prostatitis. An interesting feature of the organism is that it can spontaneously lose its cell wall and develop L forms in culture. Organisms have been isolated from blood and from aspirates from various sites, including lymph nodes. *S. moniliformis* is inhibited by sodium polyanethol sulfonate at concentrations present in commercially available blood culture media. Specimens should be mixed with equal volumes of 2.5% sodium citrate to prevent clotting, inoculated into media without sodium polyanethol sulfonate, and stained with

either Gram or Giemsa stain. Cells of *S. moniliformis* are pleomorphic, Gram-negative bacilli with areas of swelling, usually measuring 0.3 to 0.5 μm by 1.0 to 5.0 μm , although extremely long filaments can be observed. *S. moniliformis* requires the presence of 15% sheep, horse, or rabbit blood, serum, or ascitic fluid for growth. It grows on blood agar incubated in a very moist environment with 5 to 10% CO_2 at 37°C. In broth medium, the organism grows toward the bottom of the tube and can have a bread crumb, cotton ball, or puffball appearance. Colonies on supplemented agar medium are 1 to 2 mm in diameter, smooth, glistening, and colorless to gray with irregular edges, and they may exhibit a fried-egg appearance like *Mycoplasma* colonies. *S. moniliformis* is oxidase, catalase, and indole negative and does not reduce nitrate; however, it hydrolyzes arginine and produces weak acid from glucose, maltose, and sucrose.

The genus *Suttonella* is a member of the family *Cardiobacteriaceae*, and *Suttonella indologenes* is the only species. Human isolates are uncommon, although it has been isolated from ocular sources and from blood cultures in patients with endocarditis. It is a plump, Gram-negative bacillus measuring 3 μm in length, which may appear in pairs, chains, and rosette formations. These organisms can appear Gram variable because they tend to resist decolorization, similar to *Kingella* and *Cardiobacterium*. *S. indologenes* is a facultative anaerobe, nonmotile organism. The colonies grow slowly on blood agar and may spread or pit the agar, similarly to those of *C. hominis*, except that *S. indologenes* colonies are gray and translucent. Growth is enhanced by CO_2 and high humidity. *S. indologenes* can be differentiated from *C. hominis* by its positive alkaline phosphatase reaction. Both organisms are oxidase and indole positive and produce acid from glucose, maltose, and sucrose.

Key characteristics of the genera discussed in this chapter are listed in Table 19-1.

Table 19-1 Differentiating characteristics of *Actinobacillus*, *Aggregatibacter*, *Capnocytophaga*, *Cardiobacterium*, *Chromobacterium*, *Dysgonomonas*, *Eikenella*, *Kingella*, *Pasteurella*, *Streptobacillus*, and *Suttonella* species^a

Organism	Indole	Oxidase	Catalase	Nitrate	Growth on MacConkey agar	Urea	Esculin hydrolysis	Glucose	Sucrose
<i>Actinobacillus</i>									
<i>A. lignieresii</i>	0	+	V	+	V	+	0	+	+
<i>A. equuli</i>	0	+	V	+	+	+	0	+	+
<i>A. suis</i>	0	+	V	+	V	+	+	+	+
<i>A. ureae</i>	0	+	+	+	0	+	0	+	+
<i>A. hominis</i>	0	+	+	+	0	+	V	+	+
<i>Aggregatibacter</i>									
<i>A. actinomycetemcomitans</i>	0	V	+	+	0	0	0	+	0

(Continued)

Table 19-1 Differentiating characteristics of *Actinobacillus*, *Aggregatibacter*, *Capnocytophaga*, *Cardiobacterium*, *Chromobacterium*, *Dysgonomonas*, *Eikenella*, *Kingella*, *Pasteurella*, *Streptobacillus*, and *Suttonella* species^a (Continued)

Organism	Indole	Oxidase	Catalase	Nitrate	Growth on MacConkey agar	Urea	Esculin hydrolysis	Glucose	Sucrose
<i>A. aphrophilus</i>	0	V	0	+	V ^b	0	0	+	+
<i>A. segnis</i>	0	0	V	+	0	0	0	+ ^w	+
<i>Capnocytophaga</i>									
<i>C. ochracea</i>	0	0	0	V	0	0	V	+	+
<i>C. sputigena</i>	0	0	0	V	0	0	+	V	+
<i>C. gingivalis</i>	0	0	0	0	0	0	0	+	+
<i>C. granulosa</i>	0	0	0	0	0	0	0	+	+
<i>C. haemolytica</i>	0	0	0	+	0	0	+	+	+
<i>C. canimorsus</i>	0	+	+	0	0	0	0	+	0
<i>C. cynodegmi</i>	0	+	+	V	0	0	V	+	+
<i>Cardiobacterium</i>									
<i>C. hominis</i>	+ ^w	+	0	0	0	0	0	+	+
<i>C. valvarum</i>	V	+	0	0	0	0	0	V	V
<i>Chromobacterium</i>									
<i>C. violaceum</i>	V	V	+	+	+	NA	0	0 ^c	0
<i>C. haemolyticum</i>	0	+	+ ^w	+	+	NA	0	+ ^w	NA
<i>Dysgonomonas</i>									
<i>D. capnocytophagoides</i>	V	0	0	0	0	0	+	+	+
<i>D. gadei</i>	V	0	+	0	0	0	+	+	+
<i>D. mossii</i>	+	0	0	0	0	0	+	+	+
<i>D. hofstadii</i>	+	0	0	0	0	0	+	+	NA
<i>Eikenella</i>									
<i>E. corrodens</i>	0	+	0	+	0	0	0	0	0
<i>Kingella</i>									
<i>K. kingae</i>	0	+	0	0	0	0	0	+	0
<i>K. denitrificans</i>	0	+	0	+	0	0	0	+	0
<i>K. negevensis</i>	0	+	0	0	0	0	0	+	0
<i>K. oralis</i>	0	+	0	0	0	0	0	+ ^w	0
<i>K. potus</i>	0	+	0	0	0	0	0	0	0
<i>Pasteurella</i>									
<i>P. multocida</i>	+	+	+	+	0	0	NA	+	+
<i>P. canis</i>	+	+	+	+	0	0	NA	+	+
<i>P. dagmatis</i>	+	+	+	+	0	+	NA	+	+
<i>P. oralis</i>	+	+	+	NA	0	0	NA	+	+
<i>P. stomatis</i>	+	+	+	+	0	0	NA	+	+
<i>Streptobacillus</i>									
<i>S. moniliformis</i>	0	0	0	0	0	0	V	+	0
<i>Suttonella</i>									
<i>S. indologenes</i>	+	+	V	0	0	0	0	+	+

^a+, positive reaction (≥90% positive); V, variable reaction (11 to 89% positive); +^w, weakly positive reaction; 0, negative reaction (≤10% positive); NA, not available.

^b*A. aphrophilus* may grow on MacConkey agar with a weak reaction.

^cA weakly positive reaction may be observed in oxidative fermentative media.

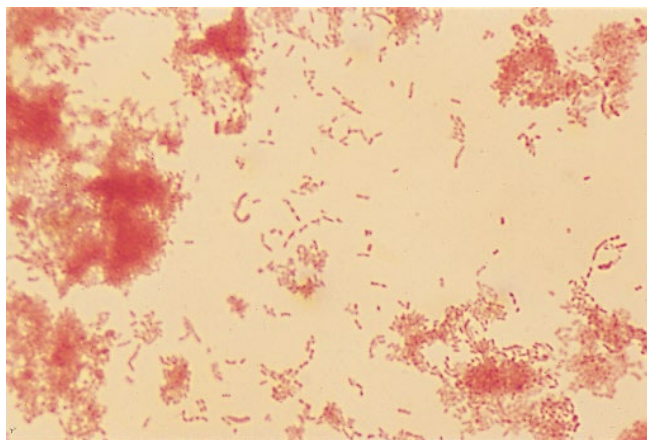


Figure 19-1 Gram stain of *Aggregatibacter actinomycetemcomitans*. *A. actinomycetemcomitans* organisms appear as small, Gram-negative coccobacilli, measuring 0.5 by 1.0 μm . They can become elongated (up to 6 μm) after repeated subcultures on media containing glucose or maltose.

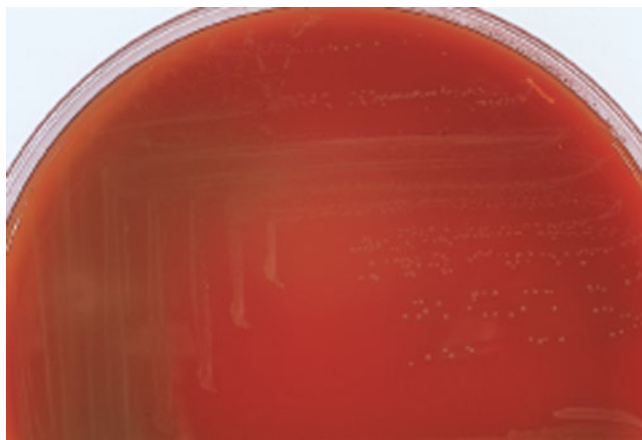


Figure 19-2 *Aggregatibacter actinomycetemcomitans* on blood agar. *A. actinomycetemcomitans* produces pinpoint to small colonies 0.5 mm in diameter after a 24-h incubation on blood agar, as shown. The colonies are smooth or rough, sticky, adherent, and surrounded by a slight greenish tinge after 48 h, as shown here. Sticky colonies may be difficult to remove from the surface of the agar. A characteristic morphology is the development of a star-like configuration in the center of a 4- to 5-day-old colony when grown on a clear medium such as brain heart infusion agar. This morphology can be visualized under low-power magnification ($\times 100$).



Figure 19-3 *Actinobacillus ureae* on blood agar. Colonies of *A. ureae* on blood agar are small, wet, slightly mucoid, and gray, measuring 1 to 2 mm in diameter. Growth on agar media resembles that of *Pasteurella* spp.

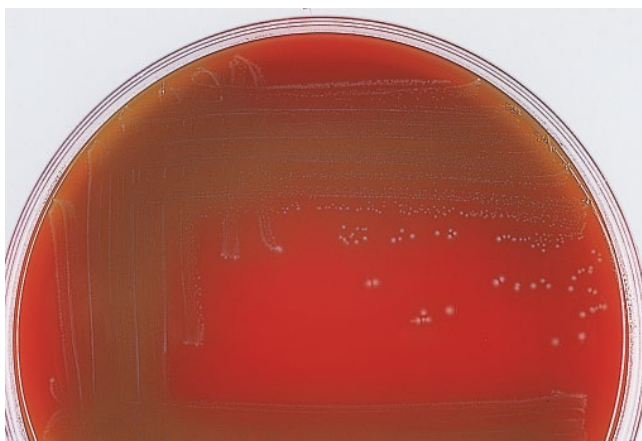


Figure 19-4 *Actinobacillus hominis* on blood agar. Colonies of *A. hominis* on blood agar after a 72-h incubation in a microaerophilic atmosphere are small, slightly alpha-hemolytic, smooth, round, glistening, and opaque, measuring 1 mm in diameter. As the colonies mature, they tend to pit the agar.



Figure 19-5 Reaction of *Actinobacillus* spp. on urea agar and in mannitol broth. The urea agar slant is positive (left) and the mannitol broth is weakly positive (right) after a 48-h incubation. All *Actinobacillus* spp. are urease positive, and they all produce acid from mannitol; however, only *A. ureae* has a delayed reaction. The positive urea reaction and delayed reaction from mannitol shown here are suggestive of *A. ureae*.

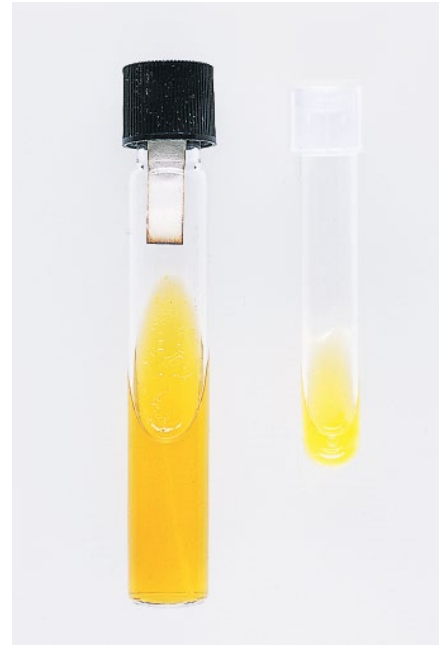


Figure 19-6 *Actinobacillus equuli* on a triple sugar iron (TSI) agar slant. *A. equuli* was inoculated onto a TSI agar slant with a lead acetate strip placed above the slant (left) and into a tube containing an ONPG tablet (right). *A. equuli* produces acid from glucose, lactose, and sucrose, the three carbohydrates in TSI medium, causing an acid reaction in the slant and butt. It produces a small amount of H₂S, which is not detected by the ferrous sulfate in the TSI medium. Therefore, a more sensitive reagent, lead acetate, is used to detect H₂S production. As shown here, the presence of a black color at the bottom of the strip indicates a positive reaction. *A. equuli* is also one of the *Actinobacillus* spp. that are ONPG positive within 2 to 4 h, resulting in a yellow color.



Figure 19-7 Gram stain of *Capnocytophaga* spp. *Capnocytophaga* spp. are thin, Gram-negative bacilli with pointed ends.

Figure 19-8 *Capnocytophaga* spp. on chocolate agar. Colonies of *Capnocytophaga* spp. incubated on chocolate agar for 48 h are small to medium sized, measuring 1 to 3 mm in diameter, and nonhemolytic. There is a haze or swarming on the surface of the agar, similar to that of *Proteus* spp. This is due to the gliding motility of the organism, a characteristic of *Capnocytophaga* spp.

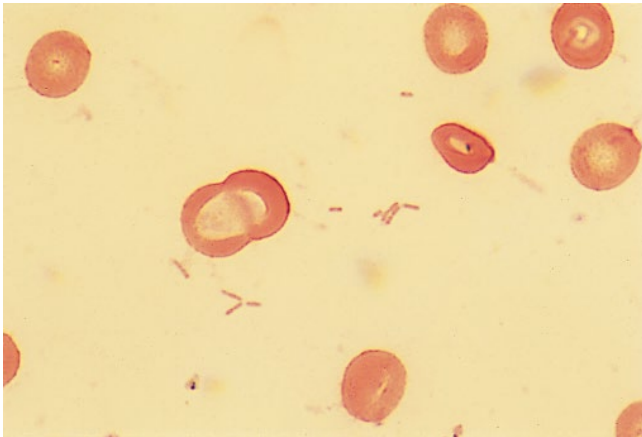


Figure 19-9 Gram stain of *Eikenella corrodens* isolated from a blood culture. This Gram stain of *E. corrodens* isolated from a blood culture shows slender, Gram-negative bacilli, measuring 0.5 μm by 1.5 to 4 μm , with rounded ends.



Figure 19-10 *Eikenella corrodens* on blood agar. Shown here are colonies of *E. corrodens* grown on blood agar and incubated for 48 h. The colonies are clear, pinpoint to small, and surrounded by flat, spreading growth. The center of the colony is pitting the agar surface, a characteristic of this organism. The colonies also produce a characteristic bleach-like odor.

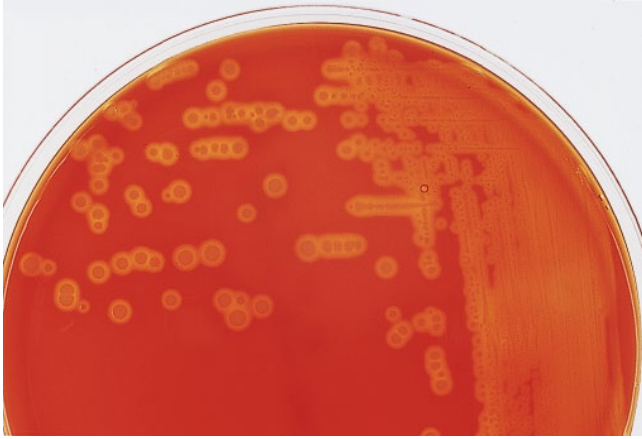


Figure 19-11 *Kingella kingae* on blood agar. Shown here are colonies of *K. kingae* incubated for 48 h. They are smooth, convex, and gray, measuring 0.5 to 1 mm in diameter, and are surrounded by a zone of beta-hemolysis. In contrast, colonies of *K. denitrificans* are small, spreading, and nonhemolytic and frequently pit the agar.

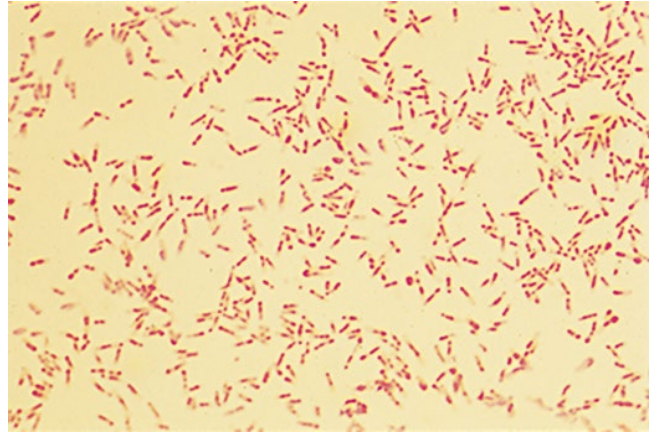


Figure 19-12 Gram stain of *Cardiobacterium hominis*. This Gram-stained smear of *C. hominis* from an agar plate shows pleomorphic, Gram-negative bacilli with pointed and swollen ends in palisade formation, measuring 0.5 to 0.75 μm by 1.0 to 3.0 μm . Some strains retain the crystal violet in the swollen ends or central portion of the cells. They also can appear in rosette clusters.

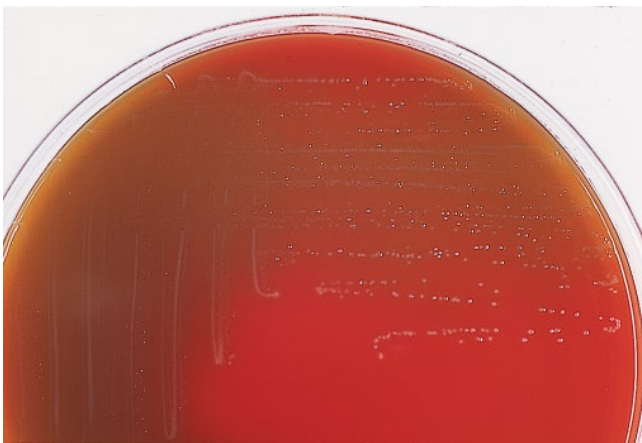


Figure 19-13 *Cardiobacterium hominis* on blood agar. Colonies of *C. hominis* on chocolate or blood agar are small (0.5 to 1.0 mm in diameter), slightly alpha-hemolytic, smooth, round, glistening, and opaque after 48 h of incubation. If they are incubated aerobically, growth is scant unless the humidity is increased or they are incubated under a microaerophilic atmosphere (candle jar). Mature colonies tend to pit the agar.



Figure 19-14 Indole reaction of *Cardiobacterium hominis*. Indole formation is an important characteristic of *C. hominis*. Indole production may be weak and may not be detected by procedures that do not concentrate the indole by xylene extraction, as seen by the reddish color at the surface of the xylene in this tube.

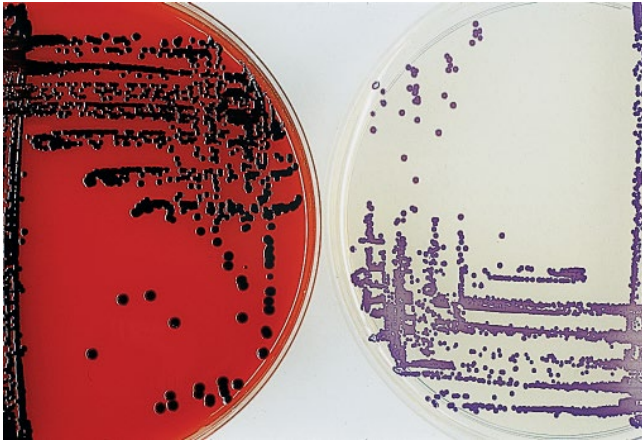


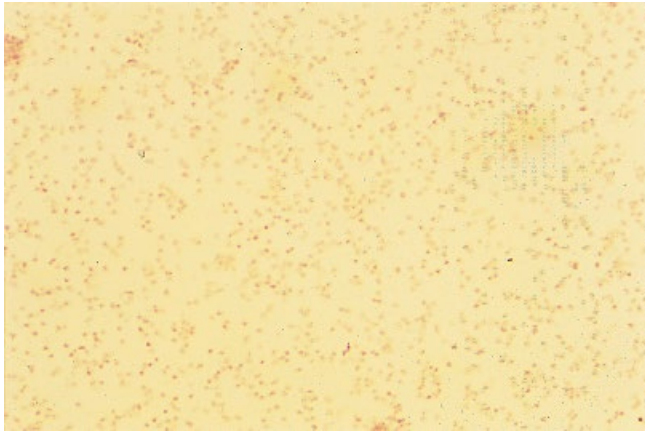
Figure 19-15 *Chromobacterium violaceum* on blood agar and Mueller-Hinton agar. Colonies of *C. violaceum* are 2 to 4 mm in diameter, round, smooth, and convex, with a very dark purple (violet) pigment. Shown here are colonies of *C. violaceum* growing on blood agar (left) and Mueller-Hinton agar (right). It is difficult to determine the pigment color on blood agar because of the presence of erythrocytes in the medium, while the color on Mueller-Hinton agar is clearly violet. These colonies produce an odor of ammonium cyanide.



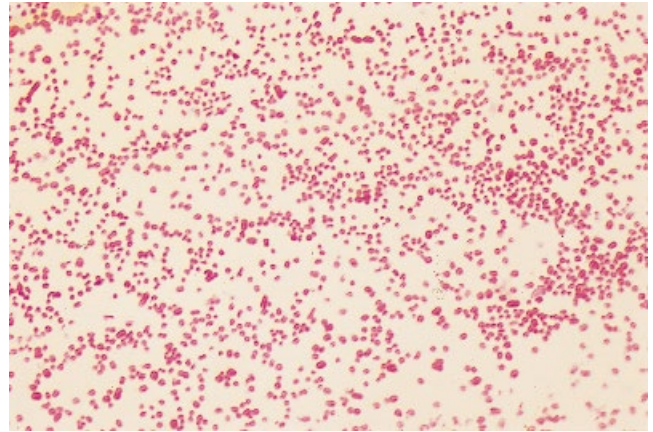
Figure 19-16 *Streptobacillus moniliformis* in broth medium. *S. moniliformis* is a fastidious organism that requires supplementation with blood or horse serum for growth. Growth on agar media may require 7 days of incubation before it is visualized. Here, the organism is growing toward the bottom of the tube with bread crumb-like morphology on the left side of the tube, a characteristic of *S. moniliformis*.

Figure 19-17 Indole and nitrate reactions of *Chromobacterium violaceum*. The indole test is shown on the left, and the nitrate test is shown on the right. In contrast to *Cardiobacterium hominis*, with *C. violaceum* the indole test is negative (colorless) and the nitrate test is positive (red color), indicating that nitrate has been reduced to nitrite





A



B

Figure 19-18 Gram stain of *Pasteurella multocida*. The organisms were counterstained with safranin (A) and carbol fuchsin (B). The pleomorphic structure of *P. multocida* is evident in both panels. These pleomorphic, Gram-negative organisms may be coccobacillary, with ovoid, short bacilli measuring 0.5 to 1.0 μm , or filamentous; they may have bipolar staining and can occur singly, in pairs, or in short chains. A capsule is frequently observed in clinical isolates.

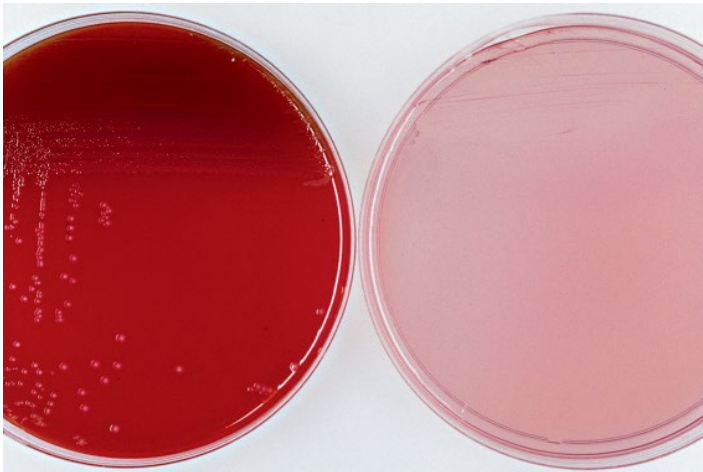


Figure 19-19 *Pasteurella multocida* on blood agar and MacConkey agar. *P. multocida* produces small (1- to 2-mm-diameter), gray colonies on blood agar (left) but does not grow on MacConkey agar (right). A characteristic odor, similar to that of *Escherichia coli*, results from the production of indole.



Figure 19-20 Identification methods for *Pasteurella multocida*. Shown here is the API 20NE (bioMérieux, Inc., Durham, NC), one of the kits available for the identification of nonfastidious, Gram-negative bacteria that do not belong to the *Enterobacterales*. This assay combines 8 conventional and 12 assimilation tests.

Legionella

20

Legionella spp. are thin, faintly staining, non-spore-forming, pleomorphic, Gram-negative bacilli that are found in the environment, particularly in bodies of water and in domestic sources of stagnant or warm water, e.g., cooling systems and hot tubs. They are known to survive low levels of chlorine and thus can colonize water supplies. There are currently 59 species within the genus *Legionella*, which is the only genus in the family *Legionellaceae*. The majority of human infections are caused by *Legionella pneumophila*, *Legionella micdadei*, *Legionella longbeachae*, and *Legionella dumoffii*. These organisms are thought to be transmitted to humans from an aerosolized contaminated water source, and thus, *Legionella* infections primarily affect the respiratory tract; however, dissemination and extrapulmonary involvement have been documented (e.g., pericarditis, pyelonephritis, and peritonitis). The one exception is that *L. longbeachae* is thought to be transmitted from contaminated soil and not necessarily water. The two main forms of *Legionella* infections are pneumonia (Legionnaires' disease) and Pontiac fever. *L. pneumophila* serogroup 1 is responsible for >90% of the pneumonia cases, even though there are more than 50 serogroups of *L. pneumophila*. Legionnaires' disease has been reported to have a mortality rate of up to 25% in untreated patients, especially those who are immunocompromised. Once inhaled, *Legionella* infects human macrophages, in particular alveolar macrophages. The organisms possess several genes, including those belonging to a type IV secretion system, that enable them to evade host defenses, multiplying and surviving in an

intracellular host environment. Unlike Legionnaires' disease, Pontiac fever, an acute, self-limiting flu-like illness, is thought to be due to an inhaled toxin or an allergic reaction.

Legionella spp. are difficult to see on a routine Gram stain and therefore can be better visualized with a carbol fuchsin rather than safranin as a counterstain. Organisms visualized from direct smears are small (3 to 5 μm) and coccobacillary, in contrast to the long (10- to 25- μm), slender, Gram-negative bacilli seen in cultures. A direct fluorescent-antibody test is commercially available but is limited to the detection of *L. pneumophila*. In general, direct staining of specimens, due to the small number of organisms present, has a low sensitivity. Culture is the recommended laboratory test because it detects all species and serogroups. Specimens for culture can be from all sites; however, lower respiratory tract specimens, especially expectorated sputum, are the most common. Often there is a paucity of polymorphonuclear leukocytes in the respiratory specimens, and therefore, cellular evaluation of the specimen should not be an exclusion criterion for culture. In cases of pneumonia, transtracheal aspirates may yield better recovery than sputum or bronchoscopy specimens. Of note, some species from clinical specimens are acid fast, e.g., *L. micdadei*, which along with their small size may be a clue to their presence.

Legionella spp. are motile aerobic organisms that require L-cysteine for growth, exhibit enhanced growth with iron under 5% CO_2 , and are asaccharolytic and relatively inert biochemically. Enriched media, such as buffered charcoal-yeast extract (BCYE) containing

α -ketoglutaric acid, with and without antibiotics, should be included among the primary culture media. Specimens for culture should be plated both undiluted and diluted to reduce inhibitory substances in the sample and can be decontaminated to reduce members of the normal microbiota that may be present that can interfere or mask detection of the *Legionella*. Growth can be detected on plates that have been incubated in 5% CO₂ for 3 to 5 days at 35°C. However, plates should be inspected for growth for up to 2 weeks. Microscopically, colonies resemble cut glass, and some species have a brown pigment or fluorescence. While biochemicals have not been particularly helpful in identifying *Legionella* spp., hippurate hydrolysis has been used to differentiate *L. pneumophila*, which is hippurate positive, from the majority of the other *Legionella* spp. *Francisella tularensis*, mainly due to its delayed growth and dependence on cysteine, has the potential to be misidentified as *Legionella*. However, colonies of the two genera differ greatly. Monoclonal or polyclonal antibodies can be used to presumptively identify *Legionella*, but definitive identification to the species level and typing usually require more

in-depth genetic analysis. Matrix-assisted laser desorption ionization-time of flight mass spectrometry can also be used to identify isolates; however, a limitation at present is the number of *Legionella* spp. in available databases. In addition to culture, molecular assays are available, and nucleic acid amplification tests for *Legionella* are included in commercial syndromic respiratory panels. Antimicrobial susceptibility testing is not routinely performed due to a lack of standardized methods.

Testing for *L. pneumophila* urinary antigen is a rapid test with a specificity of $\geq 99\%$ but is limited to the detection of *L. pneumophila* serogroup 1. The sensitivity of the assay depends on the severity and stage of the pneumonia, but a general figure of 80% has been established in at least one large study.

Serological testing of single serum specimens may be helpful in establishing a diagnosis when a high titer (>128) to *Legionella* is present, especially if the patient is from a geographical area where background titers are known to be relatively low. Paired serum specimens that show seroconversion or a 4-fold rise in titer are highly suggestive of active infection.

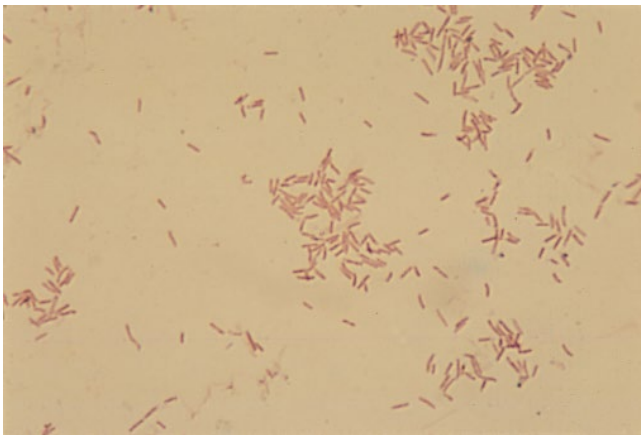


Figure 20-1 Gram stain of *Legionella*. *Legionella* spp. are thin, Gram-negative bacilli that stain faintly with a safranin counterstain. They measure 1 to 2 μm by 0.5 μm but can show variation, with bacilli up to 20 μm in length.

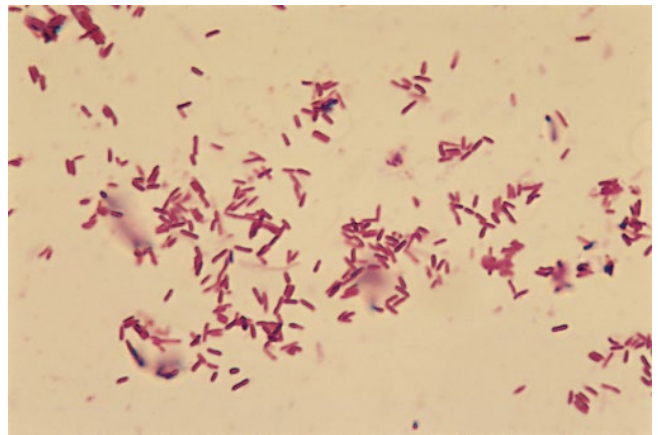


Figure 20-2 Gram stain of *Legionella* with carbolfuchsin as the counterstain. A Gram stain of the *Legionella* isolate shown in Fig. 20-1 was performed using carbolfuchsin as the counterstain. Here, the organisms are easier to see because they stain much darker.

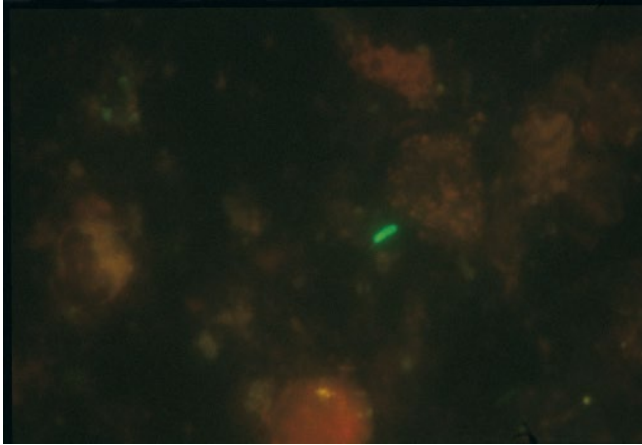


Figure 20-3 Direct fluorescent-antibody stain of *Legionella pneumophila*. A direct fluorescent-antibody stain of an expectorated sputum specimen was positive for *L. pneumophila*. This organism was identified as *L. pneumophila* serogroup 1. The fluorescent-antibody stain is more sensitive for detecting this organism directly from sputum than is the Gram stain because there are often few organisms and the specimen may be mixed with members of the oropharyngeal microbiota.

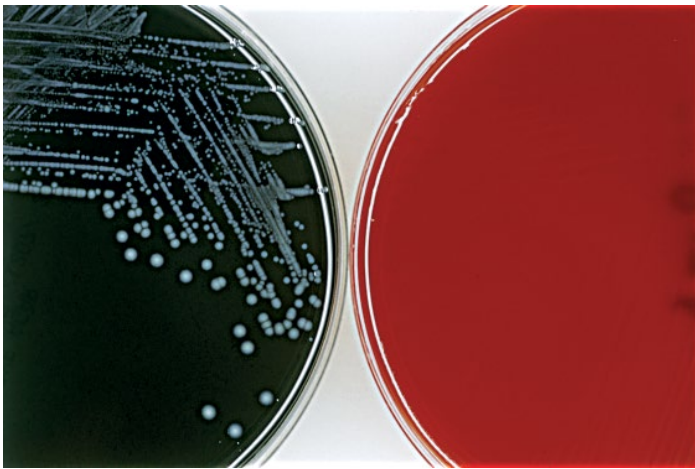


Figure 20-4 *Legionella* on media containing cysteine. *Legionella* spp. require cysteine-containing media for growth. Pictured is an isolate of *Legionella* on BCYE agar (left), which is supplemented with cysteine, and on sheep blood agar (right). The plates were incubated for 5 days. As shown, there is growth on the BCYE agar but not on the blood agar.



Figure 20-5 Sputum specimen cultured on BCYE agar with and without antibiotics. Pictured is a sputum specimen that was plated onto BCYE agar with (left) and without (right) antibiotics. Since the normal respiratory microbiota can grow on BCYE agar, specimens from nonsterile sites from patients who are suspected of having a *Legionella* infection should be plated onto BCYE agar, or its equivalent, with and without antibiotics. To improve the recovery of *Legionella* from sites contaminated with normal microbiota, specimens can be treated with acid prior to culture.

Figure 20-6 *Legionella pneumophila* on BCYE agar. Colonies of *L. pneumophila* viewed microscopically under low-power magnification have a cut-glass appearance, as shown for this 5-day-old colony grown on BCYE agar.

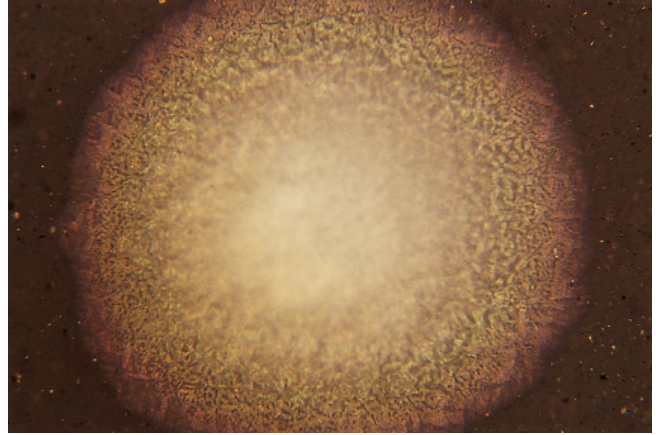


Figure 20-7 *Legionella* viewed under long-wavelength UV light. Some species of *Legionella* fluoresce when exposed to long-wave UV light. Depending on the species, the color resulting from autofluorescence can vary from that seen here to red or yellow-green. The isolates shown here were grown on BCYE agar. *L. pneumophila* (left) does not fluoresce, while *Legionella bozemanii* (right) exhibits blue-white fluorescence.

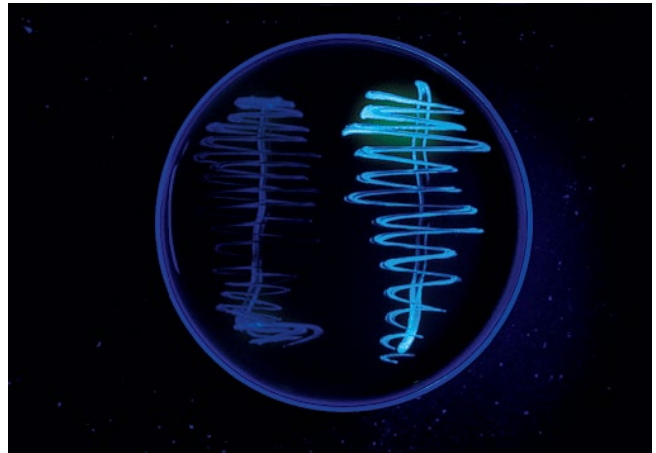
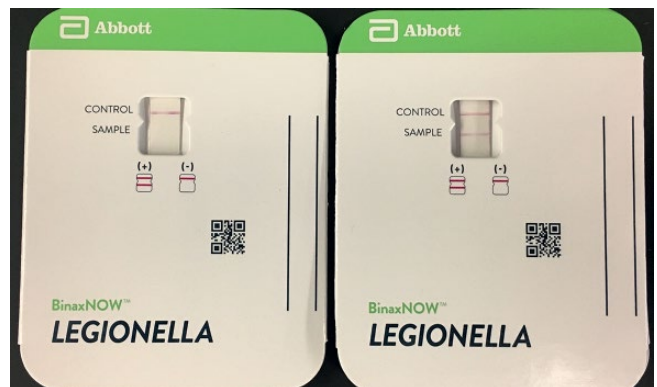


Figure 20-8 Rapid test for *Legionella* antigen in urine. Testing for the presence of *Legionella* antigen in urine is a rapid and sensitive way to aid in the diagnosis of a *Legionella* infection. A commercially available rapid immunochromatographic assay, BinaxNOW Legionella Urinary Antigen Test (Abbott Diagnostics Scarborough, Inc., Scarborough, ME), is shown here. The advantages of this test are its simplicity and rapidity. A limitation of the urinary antigen test is that it detects only *L. pneumophila* serogroup 1.



Neisseria

21

Neisseria spp. are Gram-negative diplococci with a kidney bean shape owing to the flattened side where the two cocci appear to touch. With the exception of *Neisseria gonorrhoeae*, *Neisseria* spp. are part of the human endogenous microbiota and typically inhabit the mucosal membranes of the oral cavity and occasionally the genital tract. *N. gonorrhoeae* and *Neisseria meningitidis* are commonly associated with human disease. However, most *Neisseria* spp. are commensal organisms, including *Neisseria cinerea*, *Neisseria elongata*, *Neisseria flavescens*, *Neisseria lactamica*, *Neisseria mucosa*, *Neisseria sicca*, and *Neisseria subflava*.

N. gonorrhoeae is restricted to humans and is always considered a pathogen when detected. It is the causative agent of gonorrhea, a leading reportable sexually transmitted infection, and is found most frequently in genital, rectal, and throat specimens. The most common manifestation in males is urethritis, and that in females is cervicitis. Often, especially in females, genital infections are asymptomatic. *N. gonorrhoeae* is capable of ascending the genital tract, can be disseminated, and has been isolated from blood and joint fluid. Transmission of *N. gonorrhoeae* at birth can occur and typically manifests as an ocular infection in the newborn.

Isolation of *N. gonorrhoeae* is often attempted from a specimen with an abundant normal microbiota; therefore, selective media must be used to optimize recovery. Modified Thayer-Martin agar is one of the most widely used media for isolation of *N. gonorrhoeae*. It contains colistin (to inhibit Gram-negative organisms), vancomycin (to inhibit Gram-positive organisms), nystatin (to

inhibit yeast), and trimethoprim (to inhibit the swarming of *Proteus* spp.). *N. gonorrhoeae* is fastidious, is susceptible to cold, and requires a capnophilic atmosphere. To optimize recovery, upon collection, specimens are inoculated into a medium which is incorporated into devices that provide a CO₂ atmosphere so that the organisms can be transported under the appropriate environmental conditions. Some transport systems are flushed with CO₂ and the medium is inoculated, while with others, a CO₂ environment is chemically generated after inoculation. Alternatively, the candle jar is the traditional method of generating a CO₂ environment for holding inoculated media. Direct detection of *N. gonorrhoeae* from urine or genital specimens based on nucleic acid amplification methods has, for the most part, replaced traditional culture methods to detect genital infections. This is in part due to the increased sensitivity, the ease of obtaining urine from males, and the ability to test for *Chlamydia trachomatis* from the same specimen.

There are 12 serogroups of *N. meningitidis* that colonize the oral mucosal membranes of about 10% of the population. *N. meningitidis* is capable of causing a variety of clinical presentations, the most common and serious being meningitis and septicemia. This organism is known for its potential to cause infections that take a fulminant course, with rapid progression leading to considerable morbidity and mortality. Patients with disseminated infection may have extensive vascular involvement, manifested by a petechial or purpuric skin rash or even disseminated intravascular coagulation. While the number of cases of fulminant meningococemia is low,

Table 21-1 Selected biochemical reactions used to distinguish between the more commonly isolated *Neisseria* spp. and *Moraxella catarrhalis*^a

Species	Glucose	Maltose	Lactose	Sucrose	DNase	Butyrate esterase
<i>N. gonorrhoeae</i>	+	0	0	0	0	0
<i>N. meningitidis</i>	+	+	0	0	0	0
<i>N. lactamica</i>	+	+	+	0	0	0
<i>N. sicca</i>	+	+	0	+	0	0
<i>N. flavescens</i>	0	0	0	0	0	0
<i>M. catarrhalis</i>	0	0	0	0	+	+

^a+, positive reaction; 0, negative reaction.

there are areas of the world known for higher rates of this fulminant manifestation, in particular the “meningitis belt” in sub-Saharan Africa. Polyvalent vaccines to prevent meningococemia specific to capsular antigens are readily available for serogroups A, C, W, and Y, and more recently, noncapsular vaccines against the poorly immunogenic serovar B have been developed.

Neisseria spp. differ in their nutritional requirements. Species such as *N. gonorrhoeae* require enriched media, e.g., chocolate agar; however, many species, including *N. meningitidis*, grow well on blood agar. As stated above, selective media are commonly used to facilitate the isolation of these organisms from other members of the normal microbiota of mucosal surfaces. Growth of *Neisseria* spp. is enhanced by humidity and a CO₂-enriched atmosphere and should be evident after 24 to 48 h of incubation at 35 to 37°C. Depending on the species and strain, colonies can differ in appearance, ranging from mucoid to dry and tenacious, being described as a “hockey puck” in that they stay intact when removed from a plate or suspended in liquid. *N. meningitidis*, due to a capsule, can often appear mucoid, whereas colonies of the other species are more dry. Most *Neisseria* spp. produce gray-brown colonies, but some have a yellow tint (e.g., *N. flavescens*, *N. subflava*, and *N. sicca*).

A key characteristic of the pathogenic *Neisseria* spp. in addition to their distinctive microscopic coffee bean or kidney bean shape is that they are commonly intracellular, predominantly in polymorphonuclear leukocytes. However, there are exceptions to this distinct microscopic morphology, in particular with *N. elongata*, which can appear as short bacilli. When direct smears

from clinical specimens are stained, it is not unusual for *Neisseria* spp. to decolorize poorly, thus appearing Gram positive. *Moraxella catarrhalis*, a cause of a variety of upper respiratory tract infections, can appear microscopically similar to *Neisseria* spp., since it also is a Gram-negative diplococcus that is frequently seen in polymorphonuclear leukocytes. For this reason, identification kits for the species-level identification of *Neisseria* often include *M. catarrhalis* in their identification schemes.

Neisseria spp. are oxidase and catalase positive. *N. gonorrhoeae* can be differentiated from the other *Neisseria* spp. by the superoxol test, which is similar to the catalase test except that it is performed with 30% hydrogen peroxide rather than the standard 3%. *Neisseria* spp. utilize carbohydrates oxidatively and, as such, produce small amounts of acid, thus making carbohydrate utilization tests, such as those involving cystine Trypticase agar (CTA) sugars, difficult to interpret. However, rapid sugar utilization tests based on acid production from glucose, maltose, lactose, and sucrose are more commonly used. With the patterns generated from these carbohydrates, along with additional tests such as those for nitrate and tributyrin hydrolysis, most isolates can be identified (Table 21-1). Alternative identification methods include detection of preformed enzymes by using chromogenic substrates and monoclonal antibody-based tests, as well as nucleic acid hybridization and amplification assays. Some identification kits combine both carbohydrate utilization and enzymatic substrate tests. More recently, matrix-assisted laser desorption ionization-time of flight mass spectrometry has also proved useful for the identification of *Neisseria* spp.

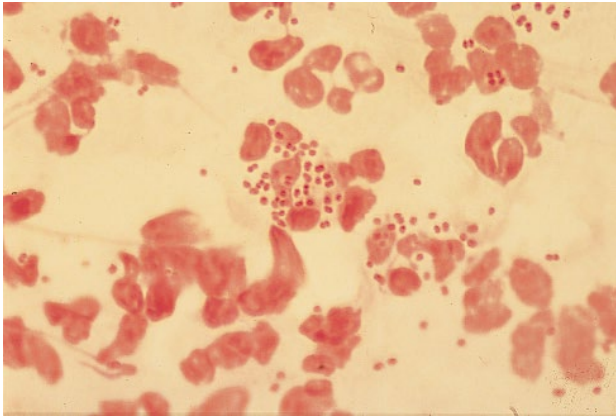


Figure 21-1 Gram stain of *Neisseria gonorrhoeae*. A Gram stain of a urethral smear from a symptomatic male shows intracellular Gram-negative diplococci with kidney bean-shaped organisms. *N. gonorrhoeae* was isolated from this specimen.

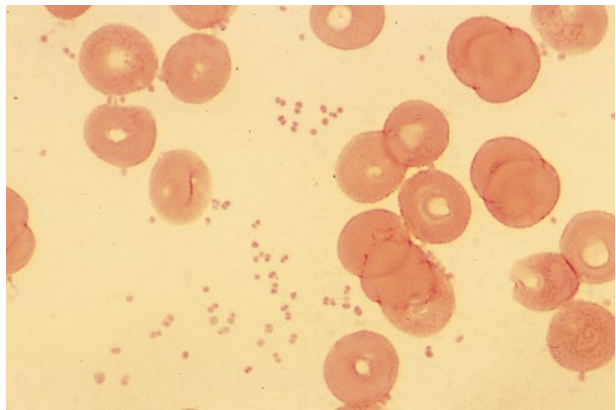


Figure 21-2 Gram stain of *Neisseria meningitidis*. A Gram stain of a positive blood culture bottle shows typical kidney bean-shaped, Gram-negative diplococci. *N. meningitidis* was isolated from this blood culture.

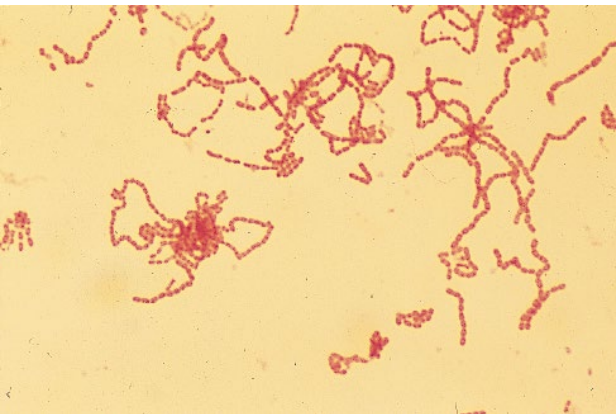


Figure 21-3 Gram stain of *Neisseria elongata*. *N. elongata* has a different microscopic morphology from most other members of this genus in that it is more bacillus shaped.



Figure 21-4 Comparison of colonies of *Neisseria meningitidis* and *Neisseria gonorrhoeae*. Colonies of *N. meningitidis* and *N. gonorrhoeae* can be differentiated when grown on chocolate agar. *N. meningitidis* (left) grows as a gray colony and imparts a green color to the agar immediately surrounding the colony. In contrast, *N. gonorrhoeae* (right) produces an off-white colony with no discoloration of the agar.



Figure 21-5 *Neisseria flavescens* on chocolate agar. Colonies of *N. flavescens*, considered part of the normal oral pharyngeal microbiota, are smooth with a defined edge and often have a yellow cast. The pigment is obvious when the colonies are picked up with a cotton swab.



Figure 21-6 *Neisseria lactamica* and *Neisseria meningitidis* on chocolate agar. Growth of *N. lactamica* (left) and *N. meningitidis* (right) on chocolate agar illustrates that differentiation between colonies of these two species is difficult. Both produce gray colonies that produce a green haze in the agar immediately under and adjacent to the colonies.



Figure 21-7 Candle jar. Agar plates are placed in a jar, a candle is lit, and the jar is sealed. When the O₂ has been consumed, the candle is extinguished, leaving an atmosphere of 3% CO₂. Inoculated agar is then transported and incubated at 35 to 37°C in this CO₂ environment. Candle jars are an alternative to commercially available systems for the transport and recovery of *N. gonorrhoeae*.



Figure 21-8 Transgrow bottle inoculation. Transgrow bottles contain Thayer-Martin medium and a CO₂ atmosphere (5 to 30% CO₂). They should be brought to room temperature before inoculation. The bottle should be held in an upright position in order to retain the CO₂. Once inoculated, it is transported to the laboratory at room temperature, where it is incubated at 35 to 37°C for up to 72 h.

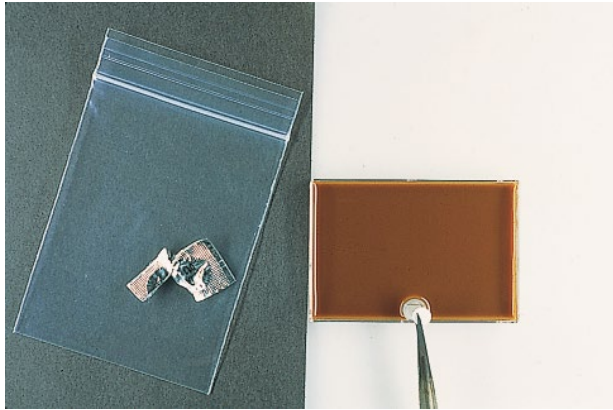


Figure 21-9 JEMBEC plates. The JEMBEC plate shown here contains a selective agar, GC-Lect agar (Thermo Fisher Scientific, Waltham, MA), designed for the enhanced recovery of *N. gonorrhoeae*. Upon inoculation of the medium with the specimen, a CO₂-generating tablet consisting of citric acid and sodium bicarbonate is placed in the JEMBEC plate, as shown. The plate is covered, sealed in the plastic bag provided, and transported to the laboratory.



Figure 21-10 Oxidase test. For the identification of *Neisseria* spp., oxidase is a key test. All members of this species are oxidase positive. In this test, filter paper is saturated with an aqueous solution of *N,N,N,N*'-tetramethyl-*p*-phenylenediamine dihydrochloride and then the colony is rubbed onto the paper. The presence of a purple color within 2 min indicates a positive test, as seen on the right.



Figure 21-11 Superoxol test. The superoxol test is performed the same way as a catalase test, except that 30% hydrogen peroxide, rather than the usual 3%, is used. The test can be used to differentiate related *Neisseria* spp. (left) from *N. gonorrhoeae* (right). If no or few bubbles appear (left), the test is negative. If the test is positive, bubbles will appear on the slide when mixed with H₂O₂ (right). However, while most other *Neisseria* spp. give weak reactions, a few species may react as strongly as *N. gonorrhoeae* (right).

Figure 21-12 CTA sugars for the identification of *Neisseria* species. A conventional method used for the identification and differentiation of *Neisseria* spp. involves the use of CTA sugars. Tubes of semisolid medium containing 1% of the indicated carbohydrate and phenol red as the indicator are inoculated with the unknown organism. The sugars used to differentiate the *Neisseria* spp. are glucose, maltose, sucrose, and lactose. In addition, basal medium with no added carbohydrate is used as a control. The top portion of the agar is inoculated, and the sugars are incubated at 35°C in an aerobic incubator with tight caps for 24 to 72 h. Some *Neisseria* spp. produce a small amount of acid, and therefore, the reactions can be easily missed. In general, CTA sugars have been replaced by other rapid commercial systems for identification. Shown is an isolate of *N. gonorrhoeae* that is positive for glucose (dextrose), as shown by the yellow reaction, and negative for the other three sugars.



Figure 21-13 DNase plate for the differentiation of *Moraxella catarrhalis* and *Neisseria* spp. *M. catarrhalis* can be distinguished from *Neisseria* spp. by its positive reaction on DNase agar containing toluidine blue. The *Neisseria* sp. on the left is DNase negative, since there is no change in the color of the agar around the inoculum. *M. catarrhalis*, which has been used to inoculate the right side of the plate in this figure, is DNase positive, which is apparent from the rose color surrounding the inoculum.



Figure 21-14 Colistin disk differentiation test. In general, commensal *Neisseria* strains are susceptible to colistin. As shown here, *N. gonorrhoeae* (left) is resistant to colistin whereas *N. sicca* (right) is susceptible, as illustrated by the large zone of growth inhibition surrounding the colistin disk. However, not all commensal strains are susceptible to colistin, as evidenced by their isolation from selective media such as colistin-containing Thayer-Martin medium.



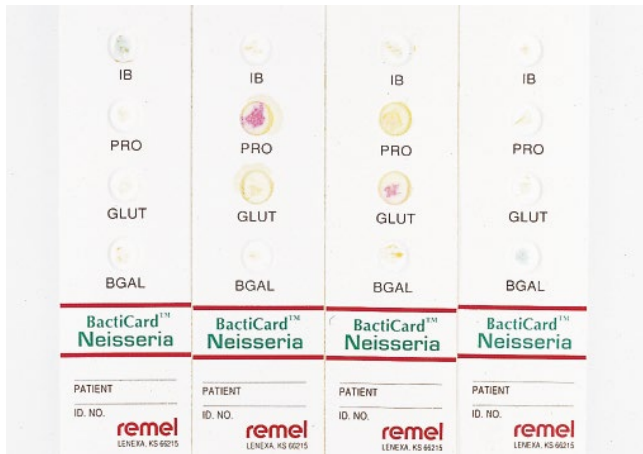


Figure 21-15 Remel BactiCard Neisseria. The Remel BactiCard Neisseria test (Thermo Scientific, Remel Products, Lenexa, KS) is an identification system consisting of four substrates that are used for the rapid presumptive identification of *Neisseria* spp. isolated from selective media. The enzymes detected and the substrates used (in parentheses) are β -galactosidase (BGAL; 5-bromo-4-chloro-3-indolyl-D-galactoside), butyrate esterase (IB; 5-bromo-4-chloro-3-indolyl-butyrate), γ -glutamyl-aminopeptidase (GLUT; γ -glutamyl-naphthylamide), and prolyl-aminopeptidase (PRO; L-proline-naphthylamide). When positive, IB and BGAL turn a blue/green color, while PRO and GLUT form a red/pink color. Shown from left to right are *M. catarrhalis* (IB positive), *N. gonorrhoeae* (PRO positive), *N. meningitidis* (GLUT positive), and *N. lactamica* (BGAL positive).



Figure 21-16 The Gonocheck-II system. The Gonocheck-II system (EY Laboratories Inc., San Mateo, CA) is used for the presumptive identification of *N. gonorrhoeae*, *N. meningitidis*, *N. lactamica*, and *M. catarrhalis*. Identification is based on the detection of the three preformed enzymes prolyl-aminopeptidase, γ -glutamyl-aminopeptidase, and β -galactosidase. Each enzyme breaks down a different substrate, resulting in one of three colors. *M. catarrhalis* should be negative for all three enzyme tests. As shown here, these colors represent identification of the following species: *N. lactamica*, blue (top left); *N. gonorrhoeae*, red/pink (bottom left); *N. meningitidis*, yellow (top right); *M. catarrhalis*, white/no color (bottom right).



Figure 21-17 API NH identification system. The API NH system (bioMérieux, Inc., Durham, NC) is composed of a penicillinase detection test and 12 identification tests, including 4 fermentation tests (glucose, fructose, maltose, and sucrose) and 8 enzymatic reactions (ornithine decarboxylase, urease, lipase, alkaline phosphatase, β -galactosidase, proline arylamidase, γ -glutamyl-transferase, and indole production). This system requires a heavy inoculum and is read after 2 h of incubation at 35 to 37°C. After the last three wells are read for lipase, alkaline phosphatase, and β -galactosidase, additional reagents are added to determine proline arylamidase, γ -glutamyl-transferase, and indole production. This system can be used for the identification of *Neisseria* spp., *M. catarrhalis*, and *Haemophilus* spp. Shown is a test strip inoculated with *N. gonorrhoeae* and read before (top) and after (bottom) the reagents are added to the last three wells.

Haemophilus

22

Haemophilus spp. are small, Gram-negative bacilli that can be found as part of the normal microbiota of the upper respiratory, gastrointestinal, and genital tracts. Human infections range from uncomplicated upper respiratory infections, including conjunctivitis, sinusitis, and otitis media, to serious and life-threatening infections, such as epiglottitis, endocarditis, and meningitis. Within this genus, most infections are caused by *Haemophilus influenzae*. However, with the advent of a vaccine against *H. influenzae* type b, there has been a dramatic reduction of childhood infections with this organism. *H. influenzae* biotype III is the causative agent of Brazilian purpuric fever. *Haemophilus aegyptius*, also known as the Koch-Weeks bacillus, is a cause of acute purulent conjunctivitis, or pinkeye, seen most frequently in young children. *Haemophilus ducreyi*, unlike most members of this genus, is a sexually transmitted organism characterized by a painful genital soft chancre that can progress to inguinal lymphadenopathy. While less frequently reported, *Haemophilus parainfluenzae*, *Haemophilus haemolyticus*, *Haemophilus parahaemolyticus*, and *Haemophilus paraphrohaemolyticus* are also capable of causing human disease. *H. parainfluenzae* is the most frequently isolated species of this genus to colonize the oral cavity. The newly described species *Haemophilus sputorum* and *Haemophilus pittmaniae* may also play a role in human infections; however, their role as causative agents of disease has yet to be defined. *Haemophilus aphrophilus* and *Haemophilus paraphrophilus* were recently transferred to a new genus, *Aggregatibacter*, and are discussed in chapter 19. *Aggregatibacter* spp. are better known for

their association with the HACEK group of organisms. The HACEK group are Gram-negative bacilli that are associated with endocarditis. *H. parainfluenzae* is also a causative agent of endocarditis and represents the “H” in the acronym HACEK.

Microscopic visualization of *Haemophilus* in direct patient material may be difficult because of its small size and faint staining. Members of this genus often exhibit pleomorphic properties, taking on filamentous forms in addition to a Gram-negative coccobacillary morphology. *H. ducreyi* tends to arrange in what is referred to as “schools of fish” or “railroad tracks.” When this morphology is seen in a smear prepared from a specimen obtained from a soft chancre, it serves as a presumptive identification of this organism.

H. influenzae may or may not be encapsulated. Capsules are the basis for serogrouping *H. influenzae* into six groups, designated groups a through f. Non-encapsulated strains are referred to as nontypeable *H. influenzae* (NTHi). Capsules are a major virulence factor of this organism, since they are antiphagocytic, although NTHi strains can cause human disease. In fact, at present, mainly due to the capsular vaccine against group b *H. influenzae*, NTHi strains are the major cause of human infection in this genus.

Haemophilus spp. are facultatively anaerobic, with maximal growth attained in an atmosphere of 5 to 7% CO₂ at 35°C. The majority of *Haemophilus* spp. grow on solid media within 24 to 48 h of inoculation. However, *H. aegyptius* and *H. ducreyi* can require up to 5 days to grow, and lower temperatures, 30 to 33°C, may favor the growth of *H. ducreyi*. These organisms are fastidious,

Table 22-1 Key reactions for the differentiation of the more common *Haemophilus* spp.^a

Organism	Requirement for factor		Hemolysis of horse blood	Fermentation of:			
	X	V		Glucose	Sucrose	Lactose	Mannose
<i>H. influenzae</i>	+	+	0	+	0	0	0
<i>H. aegyptius</i>	+	+	0	+	0	0	0
<i>H. parainfluenzae</i>	0	+	0	+	+	0	+
<i>H. haemolyticus</i>	+	+	+	+	0	0	0
<i>H. ducreyi</i>	+	0	0	0	0	0	0
<i>H. parahaemolyticus</i>	0	+	+	+	+	0	0
<i>H. paraphrohaemolyticus</i>	0	+	+	+	+	0	0

^a+, positive reaction; 0, negative reaction.

since most members have special nutritional requirements. All members require either X factor (provided by hemin) or V factor (NAD or NADP), or both. Both factors are found in chocolate agar, and therefore, this is a reliable medium on which to isolate *Haemophilus* spp. The exception to this is *H. ducreyi*, which can be difficult to recover even on chocolate agar. Blood culture medium along with the lysis of the patient red blood cells, and thus soluble X and V factors, provides a culture medium that is able to support the growth of *Haemophilus*. However, if sterile fluids containing few or no red blood cells are inoculated into blood culture broth, then a nutritional supplement containing a source of X and V factors should be added. It is not unusual for *Haemophilus* spp. that require both X and V factors to be found growing on blood agar as tiny colonies in proximity to a beta-hemolytic, NAD-producing organism such as *Staphylococcus aureus*. This is referred to as the satellite phenomenon, or satellitism, with the growth of *Haemophilus* being supported by the release of X factor from the red blood cells and production of V factor from *Staphylococcus*. A key test in differentiating among *Haemophilus* spp. is the X and V factor requirement (Table 22-1). This can be accomplished by preparing a lawn of *Haemophilus* on Mueller-Hinton agar that contains no X or V factor. Strips impregnated with these factors alone and in combination are then placed on the freshly inoculated plate and incubated overnight. The resulting growth of the organism around the strips reveals the X and V factor requirement(s). The porphyrin test is another common method to determine an X factor requirement. Here, if the organism requires X factor, owing to an enzymatic deficiency in the hemin biosynthetic pathway, it should not be able to break down the substrate δ -aminolevulinic acid. On the other hand, if an organism can break down this substrate, the by-product, a porphyrin, is detected due to its red fluorescence at 360 nm.

In addition to the X and V factor requirements, carbohydrate fermentation patterns and hemolysis on horse blood can be used to differentiate the species. For the fermentation reactions, phenol red broth supplemented with X and V factors is generally employed. Biotypes within *H. influenzae* and *H. parainfluenzae* can also be differentiated by using indole, urea, and ornithine decarboxylase tests (Table 22-2). Identification and biotyping can also be accomplished using commercially available kits and matrix-assisted laser desorption ionization-time of flight mass spectrometry.

Molecular techniques have been employed to identify *H. influenzae* directly in clinical specimens, in particular cerebrospinal fluid, as well as *H. ducreyi* in suspected cases of chancroid. Identification of *Haemophilus* from positive blood cultures is also available as part of commercial multiplex assays. Molecular identification of other species of *Haemophilus* is not commonly performed, mainly due to lack of available commercial kits, problems of sensitivity, and the inability to discriminate between pathogenic and commensal *Haemophilus* spp.

Table 22-2 Biochemical reactions for determining *Haemophilus influenzae* biotypes^a

Biotype	Indole	Urease	Ornithine decarboxylase
I	+	+	+
II	+	+	0
III	0	+	0
IV	0	+	+
V	+	0	+
VI	0	0	+
VII	+	0	0
VIII	0	0	0

^a+, positive reaction; 0, negative reaction.

Figure 22-1 Gram stain of *Haemophilus influenzae*. Shown here is a direct smear from a sputum specimen that grew a predominance of a NTHi. The organisms are small, Gram-negative coccobacilli and are fairly uniform in morphology. However, it is not unusual for this organism in a direct smear to be pleomorphic, displaying short bacilli as well as long, filamentous forms.

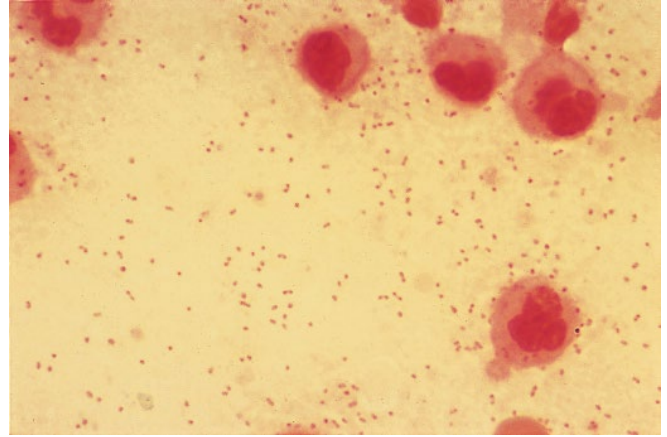


Figure 22-2 Gram stain of *Haemophilus ducreyi*. A characteristic of *H. ducreyi* is a tendency to arrange itself in what resembles schools of fish. The organisms shown here were grown in thioglycolate broth; however, if this morphology is seen in a direct Gram stain of a soft genital chancre, it is presumptive evidence of *H. ducreyi*. In the Gram stain shown, carbol fuchsin was used as the counterstain to enhance the visibility of the small bacilli.

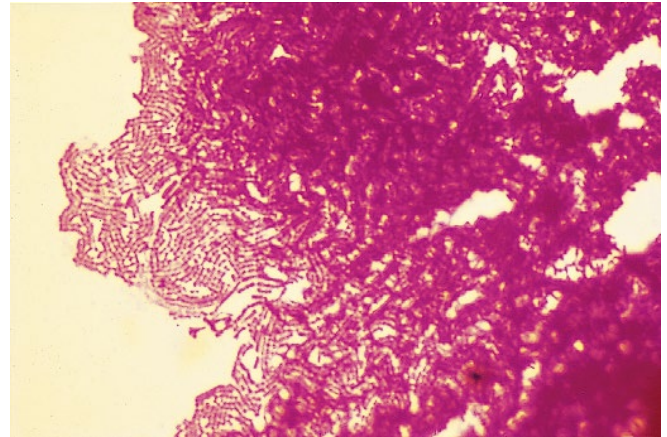
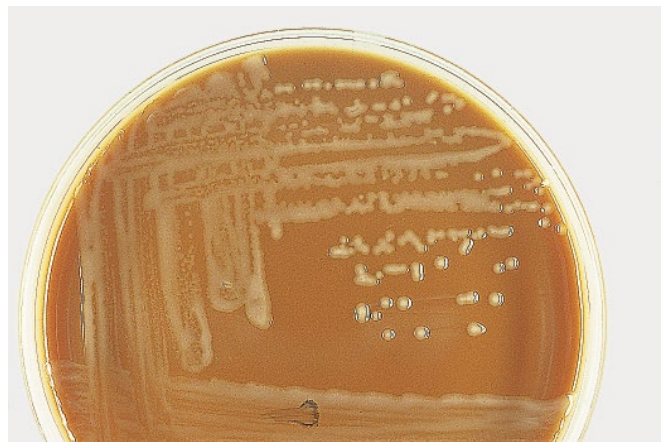


Figure 22-3 *Haemophilus influenzae* on chocolate agar. *H. influenzae* grows well on chocolate agar because, along with other essential nutrients, this medium supplies the X and V factors required for the growth of this species. The plate shown here was inoculated and incubated under 5% CO₂ at 35°C for 24 h. The colonies are gray, mucoid, and glistening.



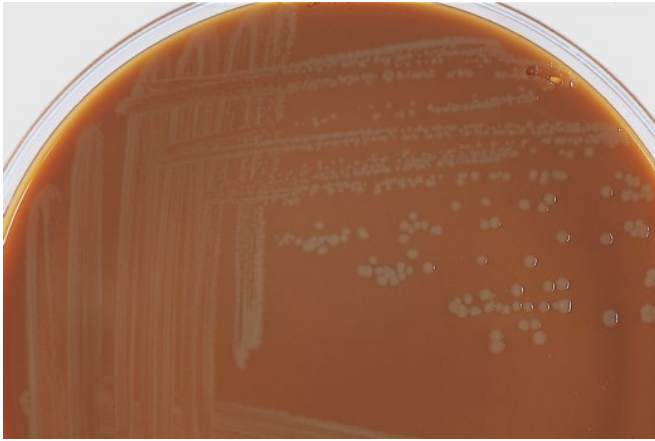


Figure 22-4 *Haemophilus aegyptius* on chocolate agar. *H. aegyptius*, or the Koch-Weeks bacillus, was grown on chocolate agar incubated under 5% CO₂ at 35°C for 48 h. The colonies are gray and glistening. In contrast to the *H. influenzae* strain shown in Fig. 22-3, they are not mucoid.



Figure 22-5 Satellite colonies of *Haemophilus influenzae*. On blood agar, *H. influenzae* can be seen growing around beta-hemolytic colonies of *S. aureus*. This phenomenon is called satellite growth. *H. influenzae* requires both X and V factors, and these are provided by hemolysis of red blood cells (X factor) and by *S. aureus* (V factor). Here, a suspension of *H. influenzae* was used to inoculate the surface of blood agar to which a streak of *S. aureus* was applied. Upon incubation, growth of *H. influenzae* can be seen to be restricted to the area adjacent to *S. aureus*.

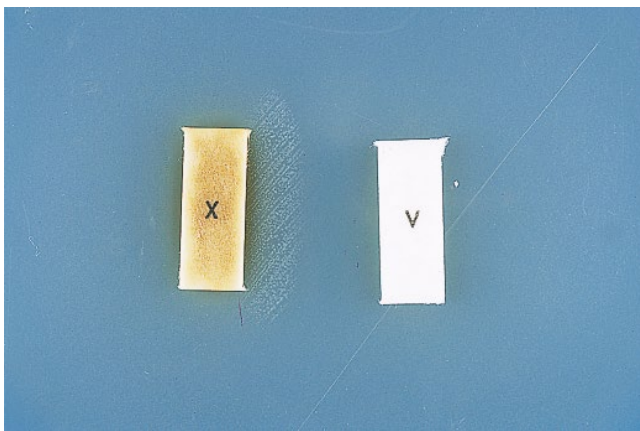


Figure 22-6 Requirement of *Haemophilus influenzae* for X and V factors. *H. influenzae* requires both X and V factors for growth. When grown on Mueller-Hinton agar, which does not contain X or V factor, *H. influenzae* grows only between the strips impregnated with X and V factors. The factors diffuse into the medium, and colonies are seen in the areas where the concentration of each factor is conducive to growth.

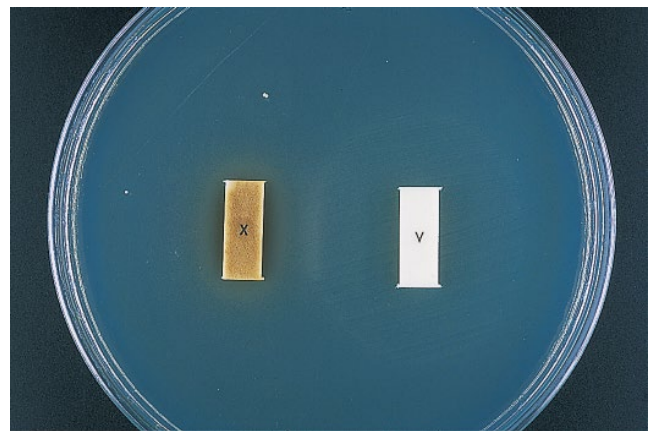


Figure 22-7 Requirement of *Haemophilus parainfluenzae* for V factor. *H. parainfluenzae* requires only V factor for growth. This is demonstrated by its ability to grow around the entire V strip on Mueller-Hinton agar, in contrast to the X strip, which has no V factor; therefore, there is no growth in the areas of the strip not adjacent to the V strip.



Figure 22-8 Porphyrin production test. The porphyrin production test is an alternative to the use of X strips to determine if an organism requires X factor for growth. In this test, an organism is inoculated into a solution of δ -aminolevulinic acid and incubated for 4 h at 35°C. If the organism can synthesize protoporphyrin compounds in the pathway to hemin production, then it does not require X factor. Since protoporphyrins are fluorescent when exposed to a UV light source, such as a Wood's lamp, their presence can be readily detected, as illustrated by the tube on the left, which exhibits fluorescence. As shown here, the organism, *H. parainfluenzae*, used to inoculate the tube on the left does not require X factor. In contrast, *H. influenzae*, used to inoculate the tube on the right, which does not show fluorescence, cannot synthesize protoporphyrins due to a lack of X factor.

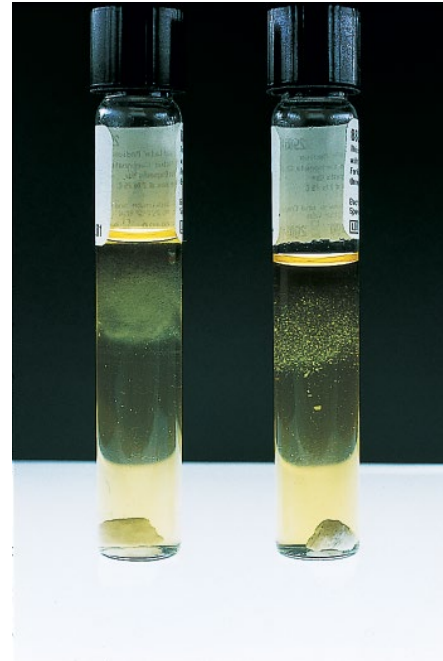


Figure 22-9 *Haemophilus influenzae* and *Haemophilus ducreyi* in thioglycolate broth. *H. influenzae* (left) and *H. ducreyi* (right) were grown for 72 h in thioglycolate broth. *Haemophilus* spp. are facultative anaerobes and grow below the surface of the broth. As shown here, *H. influenzae* forms a homogeneous layer, while in contrast, *H. ducreyi* grows in tight, small clumps.

Figure 22-10 Identification of *Haemophilus* spp. using a Hemo-ID Quad plate. As shown here, the Quad plate (BD Diagnostic Systems, Franklin Lakes, NJ) is made of sections that contain (clockwise from the top) horse blood agar, X factor, V factor, and both X and V factors. The *H. parahaemolyticus* strain used here hemolyzes horse blood and requires only V factor, as evidenced by its growth on the quadrants supplemented with V factor only and with X and V factors but not on the quadrant supplied with X factor alone.



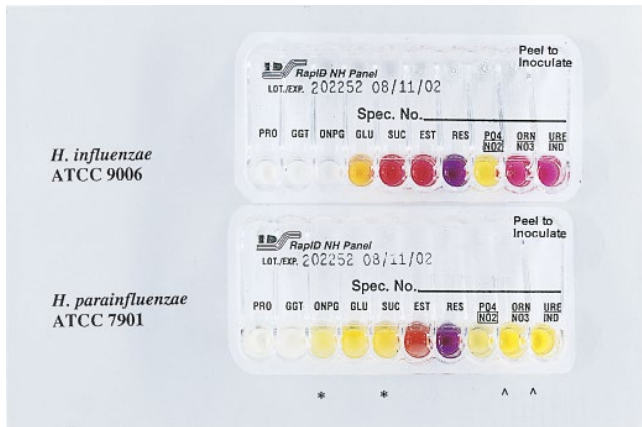


Figure 22-11 Identification of *Haemophilus* spp. by using the RapID NH system. Commercial systems such as the RapID NH system (Thermo Fisher Scientific, Remel Products, Lenexa, KS) can determine the species and biotype of members of the *Haemophilus* genus. The strip at the top was inoculated with *H. influenzae*, and the one at the bottom was inoculated with *H. parainfluenzae*. Key reactions (*) in the differentiation of these two species are *o*-nitrophenyl- β -D-galactopyranoside (ONPG) and sucrose (SUC). In addition, the key biochemicals (^) that are used to biotype *H. influenzae* and *H. parainfluenzae* are included in this rapid panel. In the example shown here, both urea (URE) and indole (IND) reactions can be determined by using the last well.



Figure 22-12 Biotyping of *Haemophilus influenzae*. *H. influenzae* and *H. parainfluenzae* strains can be biotyped using urea (left slant), ornithine decarboxylase (middle tube), and indole (right tube). As shown here, *H. influenzae* biotype III (left), which includes *H. aegyptius*, is positive only for urea, whereas *H. influenzae* biotype I (right) is positive for all three biochemical reactions.

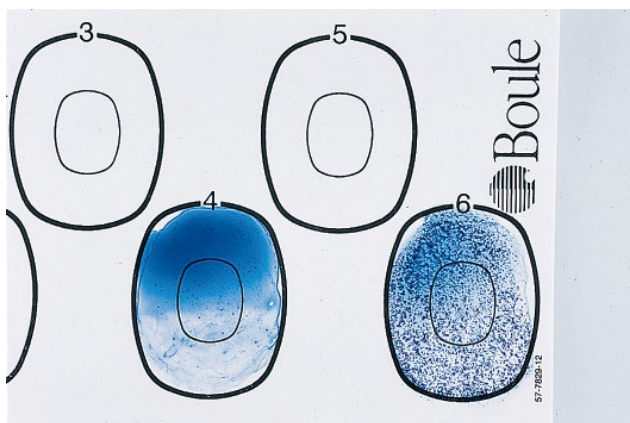


Figure 22-13 Serotyping of *Haemophilus influenzae*. Strains of *H. influenzae* can be serotyped by latex agglutination. Here, antiserum to *H. influenzae* type b (well 6) and types a and c to f (well 4) is coupled to latex particles that coagglutinate when mixed with the corresponding *H. influenzae* type. The Phadebact *Haemophilus* test (Thermo Fisher Scientific, Remel Products, Lenexa, KS) shows that the organism is *H. influenzae* type b.

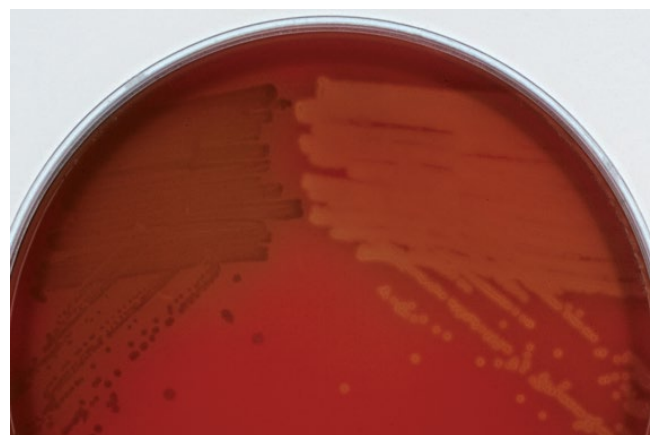


Figure 22-14 Comparison of hemolysis between *Haemophilus influenzae* and *Haemophilus haemolyticus*. *H. influenzae* (left) is nonhemolytic on horse blood agar, in contrast to *H. haemolyticus* (right), which exhibits beta-hemolysis. This characteristic is used to differentiate these two organisms.

Bordetella and Related Genera

23

Bordetella, *Achromobacter*, and *Alcaligenes* are the most clinically important genera in the family *Alcaligenaceae*. *Kerstersia*, *Aduenella*, and *Paenalcaligenes*, which are also included in this family, have been reported to be isolated from human specimens, but to a lesser extent.

The genus *Bordetella* includes 15 species, with *Bordetella pertussis* and *Bordetella parapertussis* being the most commonly found in human infections. In general, *Bordetella* spp. inhabit the respiratory tracts of humans and animals by attaching to ciliated epithelial cells by means of a filamentous hemagglutinin. Much of their pathogenesis is due to the elaboration of toxins that act as virulence factors. The pertussis toxin and the adenylate cyclase toxin are the best known, being actively expressed by *B. pertussis*, the causative agent of whooping cough (pertussis). While this infection is commonly thought of as a childhood disease, the protective immunity afforded by the vaccine that is administered in childhood is short-lived. Therefore, adults can serve as an important reservoir for this agent. However, the presentation in symptomatic adults may not be that of typical whooping cough. *B. parapertussis* can mimic the disease caused by *B. pertussis*, but in general, the course of the infection is milder. It has been estimated that only a small percentage of children with a pertussis-like presentation are infected with *B. parapertussis*. *Bordetella bronchiseptica* is mainly an animal pathogen and is known to cause kennel cough in dogs; however, it can also produce pertussis-like symptoms in immunocompromised humans. *Bordetella holmesii*, which was formerly a member of CDC nonoxidizer group 2 (NO-2), has more recently

been implicated in respiratory infections resembling whooping cough. *Bordetella trematum* has occasionally been recovered from ears and wounds. Other *Bordetella* species have rarely been isolated from clinical infections.

Bordetella spp. are small, nonfermentative, Gram-negative coccobacilli. In general, they appear very faint by Gram stain when safranin is used as the counterstain but can be more easily seen when carbol fuchsin is used instead. A direct fluorescent-antibody (DFA) test is commercially available and offers the advantage of rapidity over culture; however, there are sensitivity and specificity problems with the DFA test, and therefore, this test should be used with much caution. Nucleic acid amplification methods to directly detect this organism are the preferred direct approach for detection and identification, since they offer speed and sensitivity over other direct and culture-based methods.

These organisms are considered fastidious, since they require special media and prolonged incubation before colonies can be seen. Timely transportation and plating of specimens are essential for the recovery of *B. pertussis*. Nasopharyngeal specimens, in particular aspirates from young children, are preferred; ideally, they should be plated directly onto solid media. If they must be transported to the laboratory for culture, a transport swab that is known to preserve the viability of this organism should be used, such as a transport swab in Casamino Acids broth or a Culturette containing charcoal to absorb some of the toxic compounds associated with swabs. The classic medium used for the isolation of *B. pertussis* is

Bordet-Gengou agar (BGA), which incorporates potato infusion. Medium which contains horse blood and charcoal and to which the antibiotic cephalixin has been added, such as Regan-Lowe agar, not only supports the growth of most strains of *B. pertussis* but also suppresses normal microbiota over the prolonged incubation required, thereby increasing the recovery of *Bordetella*. Colonies of *B. pertussis* on BGA have been described as having a mercury drop-like appearance. In addition, with prolonged incubation on BGA, a zone of beta-hemolysis may develop around the colonies.

The time required before colonies are visible varies for the different *Bordetella* spp. In general, *B. pertussis* is the slowest growing, taking up to 4 days at 35°C under 5 to 7% CO₂ for visible growth to appear. Colonies of *B. parapertussis* can be seen within 2 to 3 days, while those of *B. bronchiseptica* appear within 24 h. The oxidase test can be used to separate *B. parapertussis*, which is negative, from *B. pertussis* and *B. bronchiseptica*, which are both positive. Antisera, matrix-assisted laser desorption ionization-time of flight mass spectrometry (MALDI-TOF MS), and nucleic acid amplification can be used to distinguish the last two species from one another. In addition, *B. parapertussis* and *B. bronchiseptica* are able to grow on blood agar while *B. pertussis* is not. A key characteristic that is useful in distinguishing *B. bronchiseptica* from the other two species is its ability to rapidly hydrolyze urea. This reaction can become positive within 4 h, in contrast to *B. parapertussis*, which is also urease positive but which takes 24 h for a positive result. On heart infusion medium enriched with tyrosine, *B. parapertussis* and *B. holmesii* can produce a soluble brown pigment. Characteristics that can aid in the differentiation of *Bordetella* spp. are listed in Table 23-1.

The genus *Achromobacter* is composed of six species, with *Achromobacter xylosoxidans*, the type species, being more frequently isolated from clinical material than other members, namely, *Achromobacter denitrificans*

and *Achromobacter piechaudii*. These organisms have been involved in health care-related infections related to contaminated solutions or have been recovered from immunocompromised individuals and patients with cystic fibrosis. The other three species either have not been recovered or are rarely encountered in clinical infections.

Achromobacter species are motile, aerobic, nonfermentative, catalase- and oxidase-positive, Gram-negative bacilli. They grow well on standard laboratory media, including MacConkey, sheep blood, and chocolate agars. Colonies can range in color from white to tan. *Achromobacter* can be identified by several commercial systems, but the accuracy of these varies over a wide range.

Alcaligenes species, represented by *Alcaligenes faecalis*, have been isolated from a variety of clinical material, including respiratory specimens obtained from patients with cystic fibrosis. Similar to *Achromobacter* spp., *Alcaligenes* spp. are motile, aerobic, nonfermentative, catalase- and oxidase-positive, Gram-negative bacilli that grow on standard laboratory media. *A. faecalis* is distinctive for reducing nitrite but not nitrate, and some strains have a fruity odor resembling that of apples and a green hue on blood agar.

Kerstersia includes two species, *Kerstersia gyiorum* and *Kerstersia similis*. Like other members of this family, they are nonfermentative, small coccoid to bacillary Gram-negative organisms. They grow over a wide temperature range (28 to 42°C) and in salt concentrations up to 4.5%, are oxidase positive, and vary from white to light brown to light lavender when grown on solid media. While an uncommon clinical isolate, *K. gyiorum* has been recovered from patients with chronic suppurative otitis media as well as from leg wounds; thus the name “*gyiorum*” (“from the limbs”). With greater availability of MALDI-TOF MS for the identification of isolates, reports of this organism in human disease will likely increase.

Table 23-1 Characteristics of the *Bordetella* spp. isolated from humans^a

Organism	Growth on:		Oxidase	Urease	Brown pigment ^b
	Blood agar	MacConkey agar			
<i>B. pertussis</i>	0	0	+	0	0
<i>B. parapertussis</i>	+	V (delayed)	0	+ (24 h)	+
<i>B. bronchiseptica</i>	+	+	+	+ (4 h)	0
<i>B. trematum</i>	+	+	0	0	0
<i>B. holmesii</i>	+	+ (delayed)	0	0	+

^a+, positive reaction; V, variable reaction; 0, negative reaction.

^bOn heart infusion agar supplemented with tyrosine.

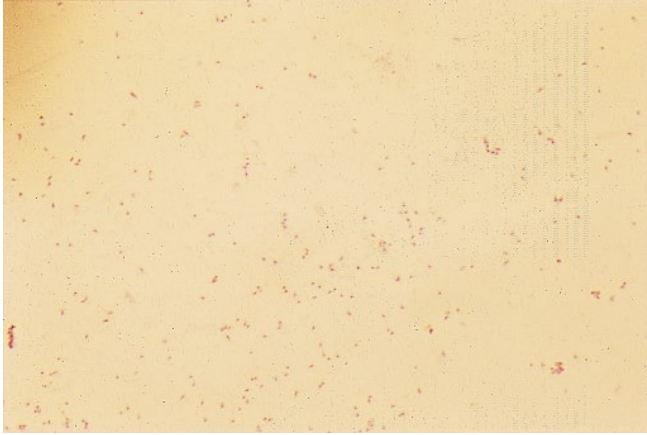


Figure 23-1 Gram stain of *Bordetella pertussis*. A routine Gram stain was performed using safranin as the counterstain. As shown, *B. pertussis* is a short, thin, faint-staining, Gram-negative bacillus.

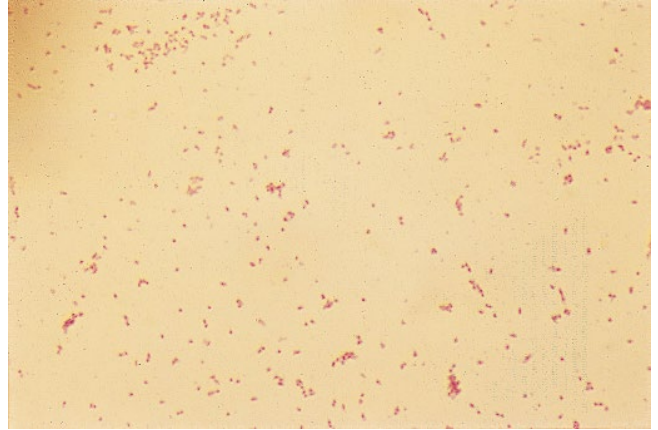


Figure 23-2 Gram stain of *Bordetella pertussis* with carbol fuchsin as the counterstain. In contrast to the Gram stain shown in Fig. 23-1, *B. pertussis* is easier to see in this image due to the use of carbol fuchsin as the counterstain.

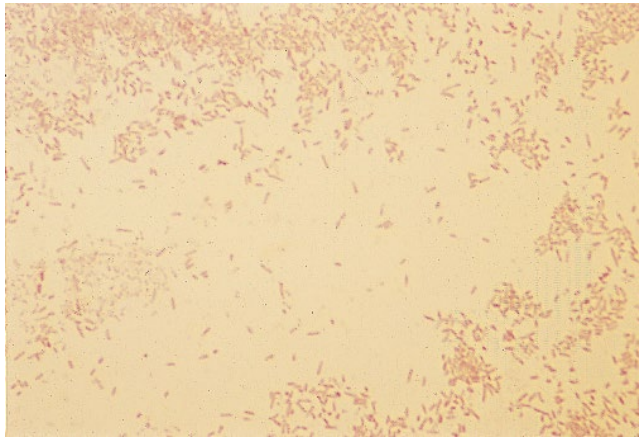


Figure 23-3 Gram stain of *Bordetella parapertussis* with carbol fuchsin as the counterstain. *B. parapertussis* is a larger, longer bacillus than *B. pertussis*. In the Gram stain shown here, carbol fuchsin was used as the counterstain to make the organisms easier to see.

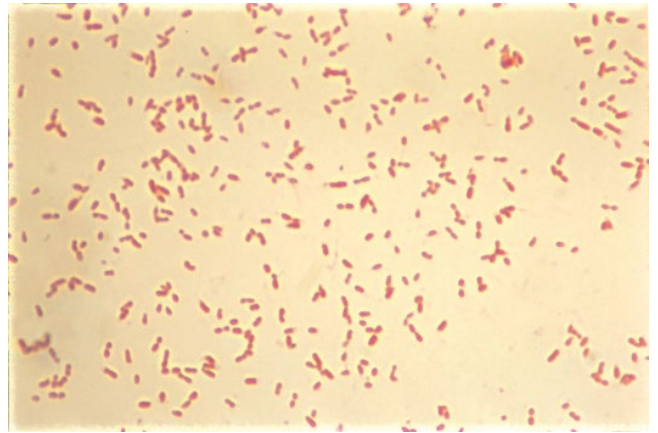


Figure 23-4 Gram stain of *Achromobacter xylosoxidans*. In this Gram stain of a pure culture of *A. xylosoxidans*, the organisms are Gram negative and vary in size from coccobacilli to small rods.

Figure 23-5 DFA stain for *Bordetella pertussis*. A smear of a nasopharyngeal specimen was directly stained with a fluorescein isothiocyanate-labeled antibody to *B. pertussis*. This smear was interpreted as positive for *B. pertussis*. The organisms shown appear as small coccobacilli that have a doughnut-like appearance, with the periphery of the cell staining darker than the center. In general, due to low sensitivity and specificity, the DFA assay has largely been replaced by more sensitive DNA amplification methods.

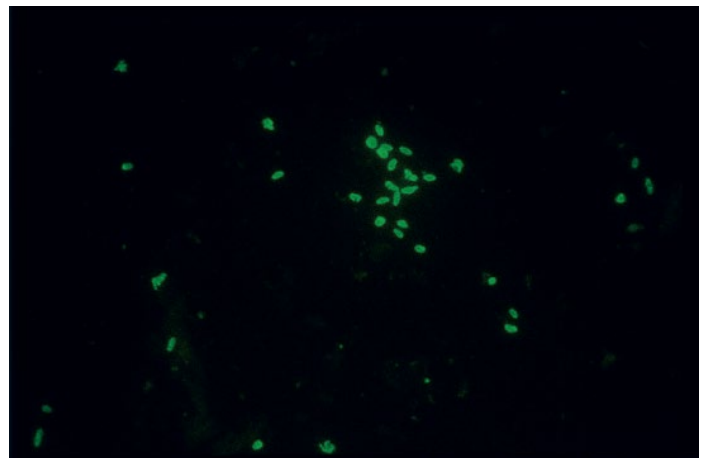




Figure 23-6 Charcoal-containing transport medium for the recovery of *Bordetella* species. Due to the fastidious nature of *Bordetella*, if specimens cannot be plated directly, a transport medium such as the one shown here is recommended. This transport medium contains charcoal to absorb toxins that may be present in the swab or specimen that can inhibit the growth of *Bordetella* spp., especially *B. pertussis*.

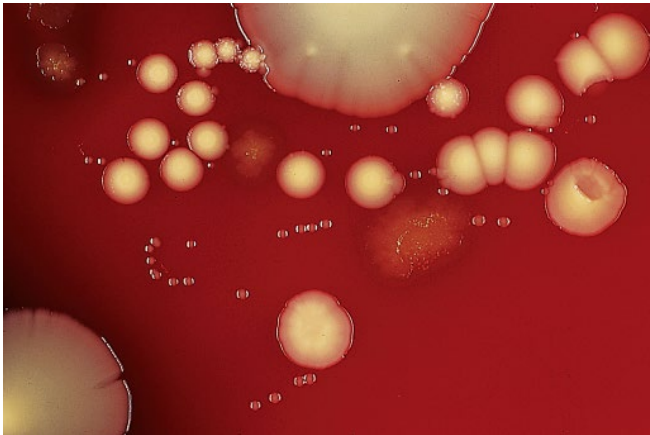


Figure 23-7 *Bordetella pertussis* on Bordet-Gengou agar (BGA). A nasopharyngeal swab was plated on BGA, which was incubated for 5 days under a humid 5% CO₂ atmosphere at 35°C. Shown here amid the normal microbiota, the colonies of *B. pertussis* are small and domed, with the typical mercury drop-like appearance.

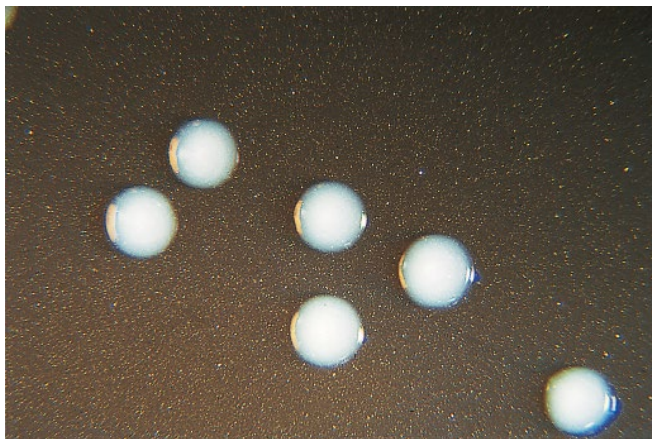


Figure 23-8 *Bordetella pertussis* on Regan-Lowe agar. Regan-Lowe medium contains horse blood and charcoal, which absorbs and neutralizes toxic substances that may be present in the agar. On this agar, colonies of *B. pertussis* have a pearly, opalescent sheen. Regan-Lowe media can be commercially obtained with and without cephalixin, which inhibits the normal nasopharyngeal microbiota.

Figure 23-9 Culture of a nasopharyngeal specimen on Regan-Lowe agar and BGA. The culture plates were incubated for 5 days at 35°C under 5% CO₂. With Regan-Lowe medium (left), which contains the antimicrobial agent cephalexin, the normal respiratory microbiota has been suppressed, making it easier to detect the small colonies of *B. pertussis*. In contrast, BGA (right) permits the growth of normal respiratory microbiota, making the isolation of *B. pertussis* difficult.



A



B

Figure 23-10 Three *Bordetella* species on BGA. The growth rates of the more common *Bordetella* spp. differ. Shown here is a BGA plate inoculated with (clockwise from the top) *B. bronchiseptica*, *B. pertussis*, and *B. parapertussis*. This plate was incubated at 35°C under 5% CO₂ and photographed at 24 h (A) and 72 h (B) of incubation. At 24 h, colonies of *B. bronchiseptica* are visible, in contrast to the 2 to 3 days required for *B. parapertussis* and the 4 days required for *B. pertussis* to show good growth.

Figure 23-11 *Bordetella bronchiseptica* on blood agar and MacConkey agar. Unlike *B. pertussis*, *B. bronchiseptica* grows on both blood agar and MacConkey agar. On MacConkey agar, it is lactose negative.

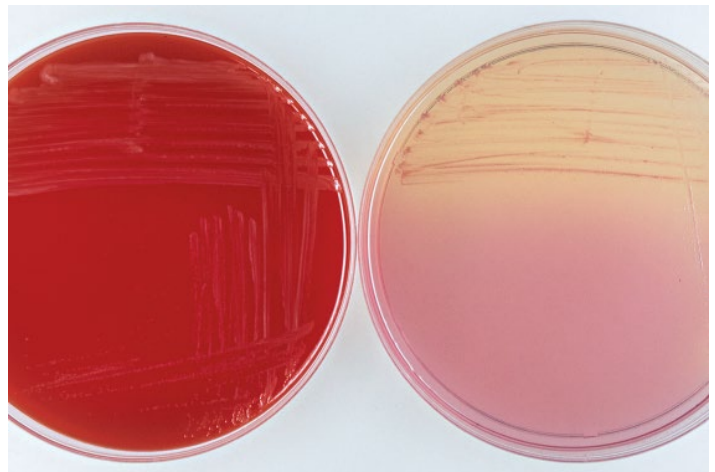




Figure 23-12 Comparison of three *Bordetella* species on urea agar slants. A key characteristic of *B. bronchiseptica* is its ability to rapidly hydrolyze urea. Positive reactions with this organism can be detected within 4 h of inoculation. *B. parapertussis* is also urease positive, but reactions may take up to 24 h to become positive. *B. pertussis* is urease negative. The urea slants were inoculated with (left to right) *B. pertussis*, *B. parapertussis*, and *B. bronchiseptica* and were incubated for 4 h (left) and 24 h (right).

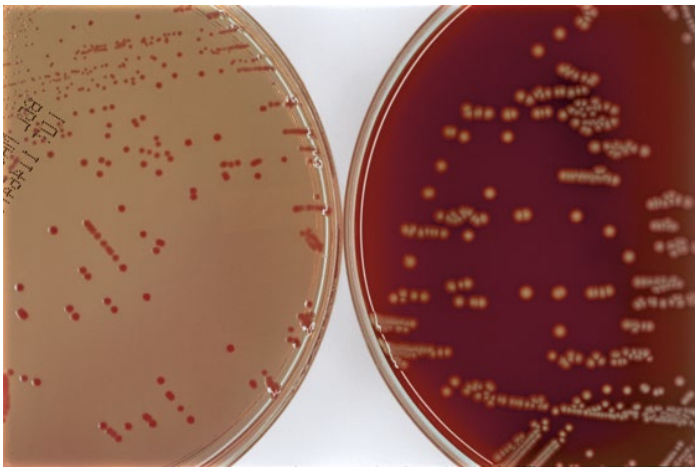


Figure 23-13 *Achromobacter xylosoxidans* on MacConkey and sheep blood agars. *Achromobacter* species grow well on both MacConkey and sheep blood agars. Shown is an isolate of *A. xylosoxidans* after overnight incubation at 35°C.

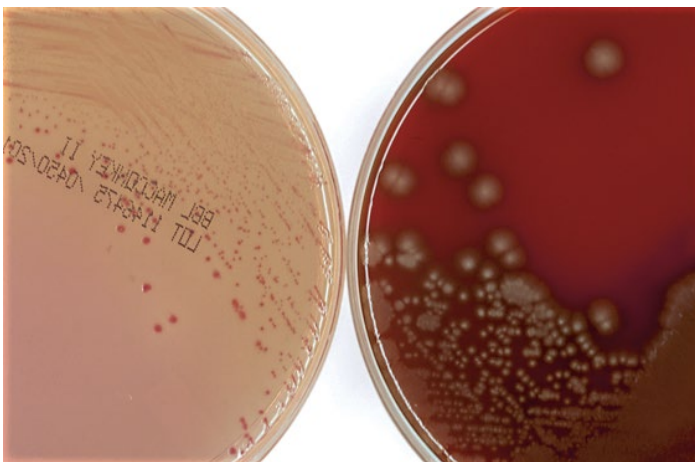


Figure 23-14 *Alcaligenes faecalis* on MacConkey and sheep blood agars. *A. faecalis* grows well on both MacConkey and sheep blood agars. A characteristic of this organism is the green discoloration surrounding the colony on sheep blood agar. The cultures shown were incubated overnight at 35°C.

Brucella

24

Four species of *Brucella*, *Brucella melitensis* (goats and sheep), *Brucella abortus* (cattle), *Brucella canis* (canines), and *Brucella suis* (swine), are human pathogens, while *Brucella neotomae*, *Brucella microti*, *Brucella papionis*, and *Brucella ovis* do not infect humans. The marine species *Brucella pinnipedialis* and *Brucella ceti* can also cause disease in humans.

The host range for *Brucella* spp. includes mammals such as cattle, horses, goats, sheep, swine, dogs, coyotes, foxes, and rodents, while the marine species were isolated from seals, whales, and dolphins. These organisms have also been found in insects and ticks. Brucellosis is a zoonosis acquired by humans as a result of ingestion of, skin or mucosal contact with, or inhalation of infected material. Human-to-human transmission can occur. Regions of endemicity include Mediterranean and Arabian Gulf countries, Mexico, Central and South America, central Asia, and India. Most of the 100 cases of brucellosis reported in the United States each year are due to consumption of unpasteurized dairy products. Specimens suspected of having *Brucella* spp. need to be handled under strict safety precautions, since the infectious dose is $<10^2$ organisms. *Brucella* spp. are classified as a type 3 biohazard and should be handled only by appropriately equipped laboratories. *B. abortus*, *B. melitensis*, and *B. suis* are designated select agents.

The clinical presentation of brucellosis may include intermittent fever, chills, weakness, malaise, aches, sweating, and weight loss. The remittent fever, termed undulant fever, appears at regular intervals and may last for years in inadequately treated patients. Several organs

and systems, including the liver, spleen, bones, joints, genitourinary tract, central nervous system, lungs, heart, and skin, can be involved. Organs of the reticuloendothelial system are frequently affected. *Brucella* spp. are phagocytosed by monocytes and macrophages and carried to the lymph nodes, spleen, bone marrow, and liver, where they may form noncaseating granulomas that can be difficult to distinguish from sarcoidosis. It is easy to confuse an infection by *Brucella* spp. with other diseases, including typhoid fever, tuberculosis, malaria, infectious mononucleosis, histoplasmosis, and rheumatic fever. *B. melitensis* produces the most serious and debilitating infections. *B. suis* is highly invasive and causes suppuration and necrosis. *B. abortus* and *B. canis* result in mild to localized infections, and complications are rare.

Members of the genus *Brucella* are aerobic, non-spore-forming, nonencapsulated, nonmotile, intracellular Gram-negative coccobacilli that measure 0.5 to 0.7 μm by 0.6 to 1.5 μm . Specimens frequently submitted to the laboratory for diagnosis include blood, bone marrow, and biopsies from the liver. Commercially available blood culture systems are reliable for the detection of *Brucella* spp., although the biphasic blood culture bottle, such as that containing Castaneda medium, appears to be the system of choice for nonautomated blood culture systems. Cultures should be held at 35°C under a 5 to 10% CO_2 atmosphere for a minimum of 21 days, and blind terminal subcultures are recommended. These organisms are catalase, oxidase, urease, and nitrate positive. Some species require complex media and CO_2 for growth (Table 24-1). Other tests that can be

used to differentiate among the four clinically important species include those for urea hydrolysis, H₂S production, and dye sensitivity. None of the commercially available systems can identify these bacteria.

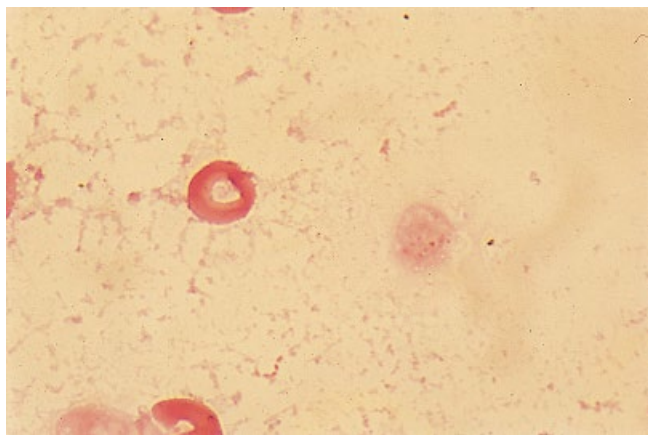
Serological testing is recommended in all cases of suspected infection, since culture alone is not reliable. Antibody titers can persist for years, and therefore, an increase in antibody titer is necessary to provide serological evidence of current disease. In general, a 4-fold rise in antibody titer between two serum

specimens collected at least a week apart is suggestive of current infection. Immunoglobulin M (IgM) antibodies appear first, followed by IgG 2 to 4 weeks later. Persistent antibody titers suggest poor response to the therapy, relapse, or chronic infections. Persistent IgG antibodies occur in 20 to 30% of treated and cured patients. The Brucellacapt test (Vircell, Granada, Spain) was recently introduced as a rapid and easy serological test. Molecular techniques are becoming available for the detection and identification of this group of organisms.

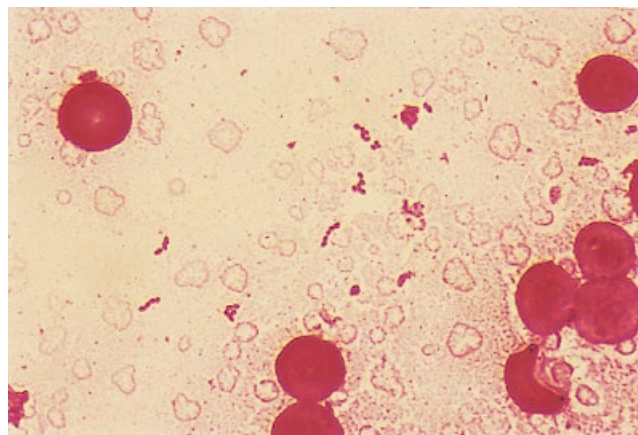
Table 24-1 Differentiation of *Brucella* species^a

Organism	Dye sensitivity		Urea hydrolysis	H ₂ S production	CO ₂ requirement
	Basic fuchsin	Thionine			
<i>B. melitensis</i>	R	R	>90 min	None	0
<i>B. abortus</i>	R	S	>90 min	2–5 days	+/0
<i>B. suis</i>	S	R	<90 min	1–6 days	0
<i>B. canis</i>	S	R	<90 min	None	0

^aR, resistant; S, susceptible; +, positive reaction; 0, negative reaction; +/-, can be positive or negative.



A



B

Figure 24-1 Gram stain of *Brucella* spp. (A) *Brucella* spp. are small, Gram-negative coccobacilli that may have a “fine-sand” appearance and are difficult to see with a safranin counterstain. (B) A modified Gram stain with carbol fuchsin as the counterstain helps to better visualize these organisms. They are usually arranged singly, but pairs, short chains, and small groups can also be found.

Figure 24-2 *Brucella abortus* on chocolate agar. Most *Brucella* spp. grow on chocolate agar, producing colonies that are small, round, raised, white to cream, and glistening. Cultures should be incubated at 35°C under 5 to 10% CO₂ for at least 7 days before being discarded.

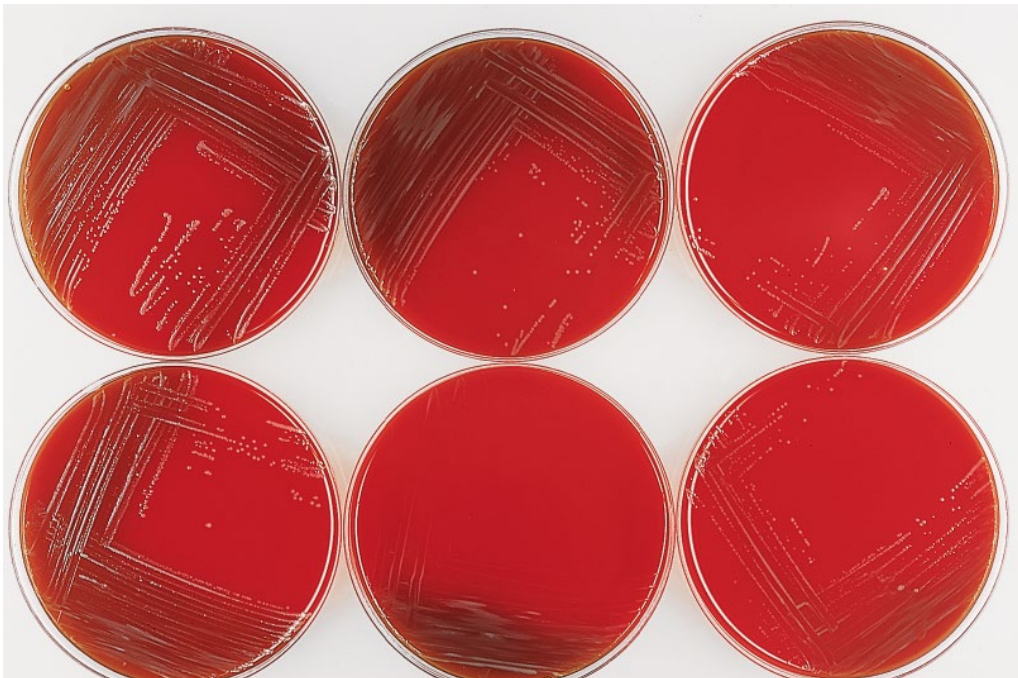


Figure 24-3 Enhancement of growth of *Brucella abortus* by CO₂. *B. abortus* grows better in the presence of CO₂, while the other *Brucella* spp. do not. The blood agar plates in the top row were incubated at 35°C under 5 to 10% CO₂, while the ones at the bottom were incubated in ambient air. From left to right, the organisms are *B. melitensis*, *B. abortus*, and *B. suis*.



Figure 24-4 Urea hydrolysis by *Brucella* spp. *B. suis* and *B. canis* hydrolyze urea rapidly (in less than 1 h), whereas *B. melitensis* and *B. abortus* take longer or may be negative. The three tubes on the left were incubated at 35°C for 1 h and those on the right were incubated for 24 h. From left to right in each group, the organisms are *B. melitensis*, *B. abortus*, and *B. suis*.



Figure 24-5 Production of H₂S by *Brucella* spp. To test for the production of H₂S, a *Brucella* slant is inoculated and a lead acetate paper strip is introduced into the tube so that it hangs down but does not touch the agar. The slant is then incubated at 35°C under 5 to 10% CO₂ for 6 days and is checked daily for blackening of the lead acetate. The paper strip should be replaced daily. *B. suis* produces a large amount of H₂S daily for the 6 days of observation, while *B. abortus* produces a moderate amount from days 2 to 5 and *B. melitensis* produces little if any. From left to right, cultures of *B. melitensis*, *B. abortus*, and *B. suis* are shown after 3 days of incubation.

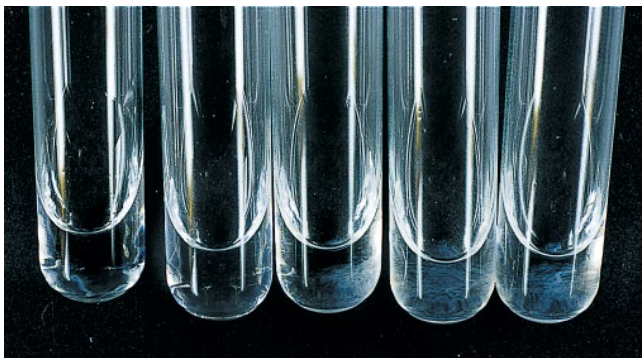


Figure 24-6 Serological testing for *Brucella* spp. Culture is not a very sensitive method for detecting *Brucella* spp. For this reason, it is recommended that serum from a patient be used to perform a tube agglutination test that can detect antibody to *B. melitensis*, *B. abortus*, and *B. suis* but not *B. canis*. A single titer of ≥160 or a 4-fold increase in antibody titer between two specimens collected 2 to 4 weeks apart is considered significant. Serial dilutions of the serum were incubated with the antigen, and agglutination was observed in two tubes (third and fourth). The tube on the left is the negative control, and the tube on the right is the positive control. The antigen used in this assay was *B. abortus*.

Bartonella

25

The following species and subspecies of *Bartonella* are associated with human infections: *Bartonella bacilliformis*, *Bartonella quintana*, *Bartonella henselae*, *Bartonella clarridgeiae*, *Bartonella vinsonii* subsp. *arupensis*, *Bartonella vinsonii* subsp. *berkhoffii*, *Bartonella grahamii*, *Bartonella elizabethae*, *Bartonella ancashensis*, *Bartonella rochalimae*, *Bartonella alsatica*, *Bartonella doshiae*, *Bartonella koehlerae*, *Bartonella schoenbuchensis*, *Bartonella tamiae*, *Bartonella tribocorum*, “*Candidatus* *B. washoensis*,” and “*Candidatus* *B. mayotimonensis*.”

While some of the species of the genus *Bartonella* have a global distribution, others are restricted to certain regions. *B. bacilliformis* is localized to the Andes because of the limited habitat of the sand fly vector, *Lutzomyia verrucarum*. *B. bacilliformis* penetrates erythrocytes, which become fragile and are cleared by the reticuloendothelial system, resulting in severe anemia causing Oroya fever, the acute form of Carrion’s disease. In some patients, a chronic nodular form, called verruga peruana, can occur weeks or months following the acute infection. *B. quintana* is transmitted by *Pediculus humanus*, the sucking louse, and has a worldwide distribution, particularly in areas with poor sanitary conditions. This organism causes the so-called trench fever or five-day fever, characterized by several episodes of acute fever, chills, headaches, shin pain, and anorexia that can recur at 5-day intervals, accounting for the name of the disease. *B. quintana* and *B. henselae* can also produce bacillary angiomatosis, most often seen in patients with HIV-1 infection, consisting of vascular

proliferation that involves the skin, subcutaneous tissues, liver, spleen, brain, lungs, and bones and can be confused with Kaposi’s sarcoma.

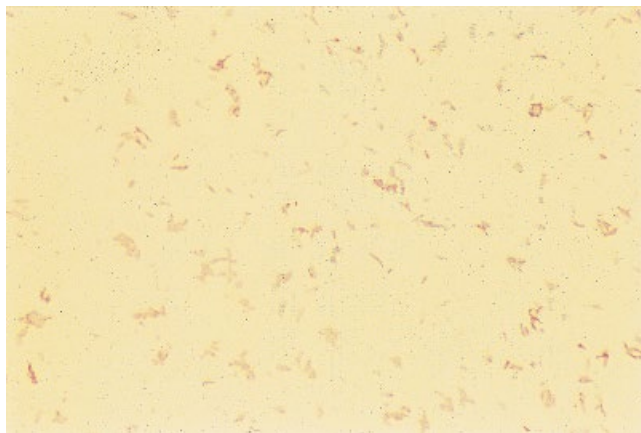
B. henselae is endemic throughout the world as a result of infection of the domestic cat; the flea *Ctenocephalides felis* appears to be the primary vector for cat-to-cat transmission. Cat scratch disease is caused mainly by *B. henselae*, although a few cases due to *B. grahamii* have been diagnosed. Approximately 25,000 cases of cat scratch disease are reported annually in the United States. Typically, following a cat bite or scratch, a pustule or papule appears at the site of inoculation accompanied by regional lymphadenopathy and fever. Bacillary peliosis due to *B. henselae* is more commonly seen in HIV-1-infected and immunocompromised patients and is characterized by the formation of cystic structures lined by endothelium in the liver and spleen. A Warthin-Starry silver stain of these lesions reveals clumps of bacilli. *B. henselae* and *B. quintana* can produce “blood culture-negative” subacute endocarditis, particularly in elderly, homeless individuals and in those with cardiac valve replacement. *B. elizabethae* and *B. vinsonii* have also been isolated from individuals with endocarditis.

Isolation of *Bartonella* spp. from human specimens in the clinical laboratory is difficult, with a low yield, and therefore, serological, histological, and nucleic acid amplification techniques are recommended. The automated blood culture systems rarely detect *Bartonella* spp. Blood and tissues are the specimens most frequently used for the isolation and detection of *Bartonella* spp. *Bartonella* spp. are small (0.2 to 0.6 μm by 0.5 to 2.0 μm), curved,

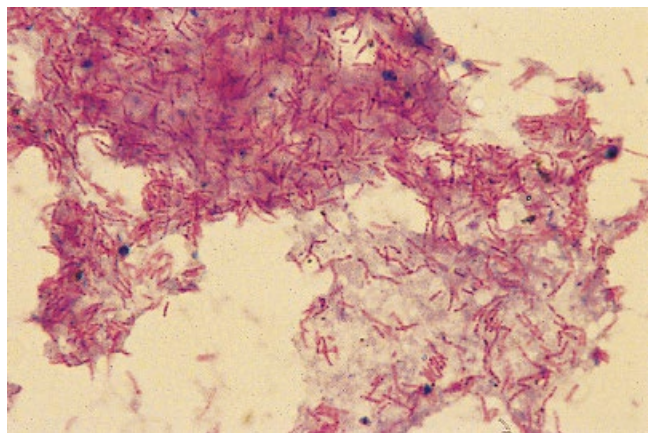
aerobic, Gram-negative bacilli that grow only on enriched media containing blood. Of the human pathogens, *B. bacilliformis* grows better at 25 to 30°C, whereas *B. henselae*, *B. quintana*, and *B. elizabethae* prefer 35 to 37°C. Chocolate agar and Columbia agar supplemented with 5% sheep or rabbit blood are the preferred media for isolation. The use of liquid insect cell growth medium as a pre-enrichment step has increased the recovery of *Bartonella* spp. from clinical samples. Cultures should be held for a minimum of 2 weeks at 35 to 37°C under 5% CO₂. *B. henselae* produces two types of colonies. One is an irregular, raised, white, dry, rough “cauliflower-like” colony that appears to be embedded in the agar, and the other is a smaller form that is tan, circular, and moist and has a tendency to pit and adhere to the agar. Tissue culture systems, including shell vials, using monolayers of endothelial cells appear to be reliable and rapid. Molecular techniques have so far been found to have limited sensitivity for the detection of *Bartonella* spp.; however, they can be used for the identification of the isolates. The current FDA-approved matrix-assisted laser desorption ionization-time of flight mass spectrometry systems do not include *Bartonella* spp.

Bartonella spp. are oxidase and urease negative, and they do not produce acid from carbohydrates. *B. bacilliformis* and *B. clarridgeiae* are motile owing to a single flagellum. Although *B. henselae* and *B. quintana* do not have flagella, a twitching motion due to the pili can be observed when a wet mount preparation is examined.

Bartonella spp. can be identified by gas-liquid chromatography of their fatty acids. The MicroScan Rapid Anaerobe Panel (Siemens Healthcare Diagnostics, Deerfield, IL) gives a unique biotype for each species of *Bartonella*. Due to the difficulties in growing these organisms, several serological tests are frequently used for the diagnosis of *Bartonella* infections in humans, although none of them is FDA cleared. Immunofluorescence antibody assays, enzyme-linked immunosorbent assays, and Western blots have been used for the diagnosis of these infections. The results from these assays, however, are not easy to interpret, since there is antigenic variability among *Bartonella* test strains and cross-reactivity can occur not only among different species of *Bartonella* but also with other pathogens, such as *Chlamydia pneumoniae*, *Coxiella burnetii*, and *Rickettsia* spp. Therefore, the sensitivity and specificity reported for serological assays vary widely.



A

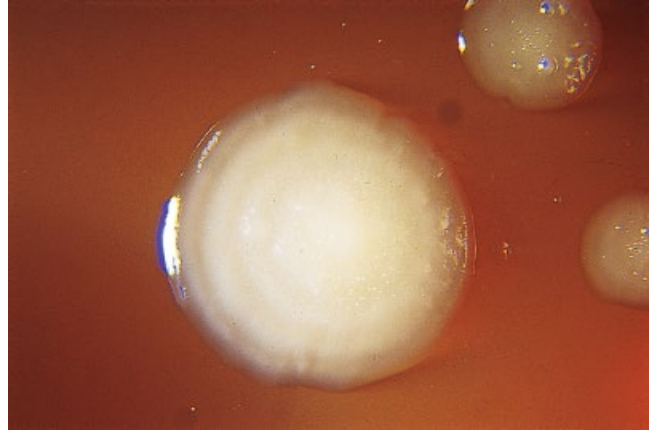


B

Figure 25-1 Gram stain of *Bartonella henselae*. (A) On a Gram stain with a safranin counterstain, *Bartonella* spp. appear as small, faintly stained, slightly curved, Gram-negative bacilli. (B) Counterstaining with carbol fuchsin gives a more distinct morphology.



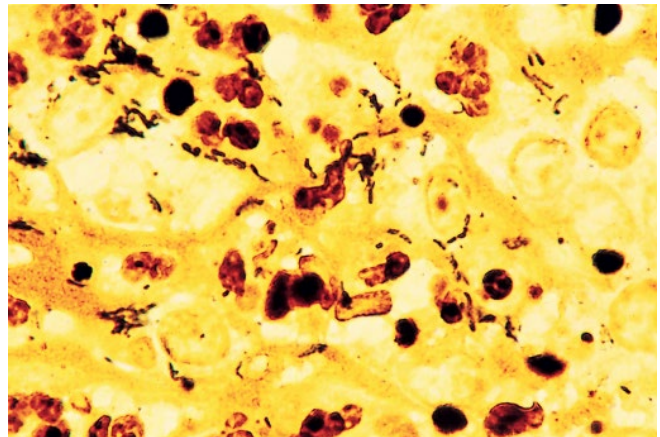
A



B

Figure 25-2 *Bartonella henselae* colonies. Large, white, irregular colonies with a cauliflower appearance, mixed with small, tan, moist colonies that pit the agar, can be observed after 5 to 7 days of incubation.

Figure 25-3 Warthin-Starry silver stain of a lymph node from a patient with cat scratch disease. *B. henselae* is present in this tissue section, predominantly surrounding blood vessels. The organisms appear as dark-brown, short bacilli, many of them in clumps.



Francisella

26

There are several species in the genus *Francisella*, including *Francisella tularensis*, *Francisella philomiragia*, *Francisella novicida*, *Francisella noatunensis*, *Francisella hispaniensis*, *Francisella halioticida*, and *Francisella persica*. Three subspecies are included in the species *F. tularensis*: *Francisella tularensis* subsp. *tularensis* (type A), *F. tularensis* subsp. *holarctica* (type B), and *F. tularensis* subsp. *mediasiatica*. *F. tularensis* subsp. *tularensis* (type A) occurs only in North America, *F. tularensis* subsp. *holarctica* (type B) can be found in the Old and the New Worlds, and *F. tularensis* subsp. *mediasiatica* has been isolated only in central Asia. An opportunistic species, *Francisella opportunistica*, has been isolated from immunocompromised patients.

More than 100 species of vertebrates and invertebrates are natural reservoirs for these organisms. The most common sources of human infection with *F. tularensis* are wild rabbits, ticks, deerflies, and mosquitoes. The number of reported cases in the United States ranges from 100 to 200 per year, resulting in one to four deaths annually, while in Europe ~700 cases are identified annually. This bacterium is extremely infectious, and only 10 organisms administered subcutaneously, or 25 by the respiratory route, are needed to cause infection. On the other hand, at least 10^8 bacteria must be ingested in order to produce an infection in the gastrointestinal tract. *F. tularensis* appears to be able to penetrate normal skin, although it may require microscopic breaks in the skin surface. Most cases of tularemia occur in the summer due to tick or deerfly bites. Other potential sources are infective aerosols created during landscaping activities, such as mowing over dead rabbits.

Clinical specimens should be handled under biosafety level 2 (BSL2) conditions and transferred to BSL3 conditions, or BSL2 conditions with BSL3 precautions, as soon as *F. tularensis* is suspected. *F. tularensis* is one of six bacteria classified by the U.S. Government as a tier 1 select agent. To receive or possess *F. tularensis* isolates in the United States, laboratories need to register with the Federal Select Agent Program. Unregistered laboratories may perform testing, but they need to destroy or transfer any select agent within 7 days after organism identification.

The clinical presentation is usually abrupt, with fever, chills, headache, and generalized pain. There are several distinct clinical forms, including ulceroglandular (cutaneous ulcer with lymphadenopathy), glandular (lymphadenopathy only), oculoglandular (conjunctivitis with preauricular lymphadenopathy), oropharyngeal (upper respiratory and cervical lymphadenopathy), pneumonic, and typhoidal, with no localizing signs or symptoms. The most common presentation in the United States is the ulceroglandular form, resulting from tick bites and contact with infected animals. Following an incubation period of 3 to 10 days, a papule forms at the site of infection, eventually ulcerates, and is accompanied by regional lymphadenopathy. *F. philomiragia* is an opportunistic organism that causes infections mainly in immunocompromised patients, in particular those with chronic granulomatous disease, and in individuals exposed to salt water, as in near-drowning cases. In most near-drowning cases, the organism was isolated from normally sterile body fluids, including the blood and cerebrospinal fluid. Fewer than 10 cases of *F. novicida*

infection have been reported. *F. hispaniensis* was first reported in Australia, and subsequently, two additional cases were identified in Spain.

Organisms in the genus *Francisella* are small, pleomorphic, Gram-negative bacilli that measure 0.2 μm by 0.2 to 1.0 μm and are obligately aerobic. Performing a direct Gram stain of tissue is not productive, because the organisms are so small that they often cannot be distinguished from background material. Safranin is a poor counterstain. A direct fluorescent-antibody (DFA) test is available in some public health laboratories and at the Centers for Disease Control and Prevention. Immunohistochemical stains using monoclonal antibodies are useful for detecting *Francisella* in tissues. Specimens that are to be amplified by PCR should be collected in guanidine isothiocyanate-containing buffer, which helps to preserve the DNA for several weeks. A limitation of nucleic acid amplification tests is that *F. tularensis* and *F. novicida* have a high degree of genetic relatedness. Matrix-assisted laser desorption ionization-time of flight methods are available only on a research basis.

Scrapings of ulcers and lymph node biopsy specimens are often submitted for culture. However, culture is not a very sensitive method. Isolation of this organism can be difficult due to its slow growth and specific nutritional requirements. The medium of choice in some reference laboratories is cystine heart agar supplemented with 9% chocolated sheep blood. Alternatively, chocolate agar supplemented with IsoVitalX or buffered charcoal-yeast extract agar can be used. To prevent overgrowth by contaminating organisms in specimens

such as ulcers and sputa, Thayer-Martin and modified Martin-Lewis media have also been used. The organism has been isolated from blood by using several commercial blood culture systems.

When grown at 35°C under 5% CO₂, colonies may take 2 to 5 days to appear. Suspect cultures should be incubated aerobically at 35 to 37°C and observed daily for up to 14 days. The colonies are small, bluish, smooth, and mucoid on cysteine-glucose blood agar and white to greenish and smooth on chocolate agar. On media containing blood, a small zone of alpha-hemolysis may appear around the colony. The organisms are oxidase negative, weakly catalase positive, and fairly inert biochemically and grow poorly, if at all, on MacConkey agar. For confirmation, a slide agglutination test with commercially available antiserum or a DFA test can be performed on a formalinized culture suspension. The most common approach for diagnosing these infections is by serological methods. Antibodies develop in most patients by 2 weeks after infection and can remain positive for more than 10 years. Immunoglobulin M antibodies can linger for many years and therefore do not imply an early or recent infection. Enzyme-linked immunosorbent assays and tube agglutination and microagglutination methods are available for the detection of antibodies to *Francisella*. A single positive titer in a patient with no history of vaccination is a presumptive diagnosis of tularemia that needs to be confirmed with another specimen collected weeks later demonstrating a 4-fold increase in antibody titer.

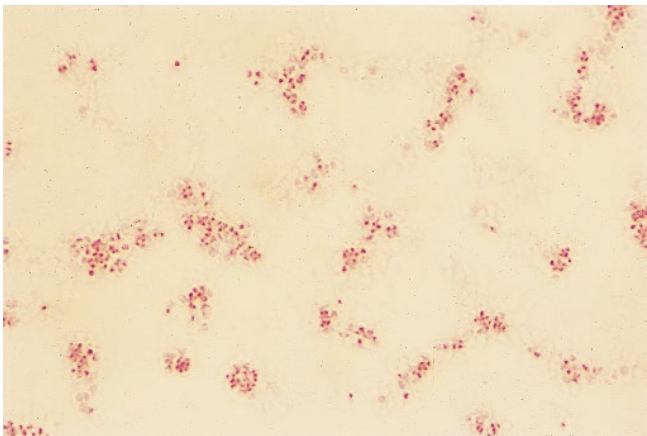


Figure 26-1 Gram stain of *Francisella tularensis*. *F. tularensis* is a minute, pleomorphic, Gram-negative coccobacillus that may exhibit bipolar staining.

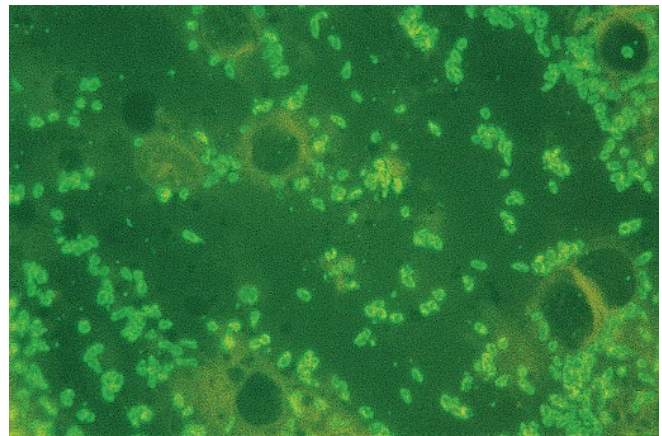


Figure 26-2 DFA staining of *Francisella tularensis*. A polyclonal rabbit antibody is available for the detection of *F. tularensis*. The pleomorphic structure of this organism is well documented here.



Figure 26-3 *Francisella tularensis* on modified Thayer-Martin agar. *F. tularensis* grows slowly, and 2 to 5 days may be needed before the colonies are visible. One of the advantages of utilizing modified Thayer-Martin medium is that it minimizes overgrowth by contaminating organisms. As shown here, the colonies are small, white-gray, smooth, and moist.

Introduction to Anaerobic Bacteria

27

Anaerobic bacteria are ubiquitous: they are commonly found in the environment, in soil as well as in water, and are also a major component of the indigenous microbiota of animals. In humans, they can outnumber aerobic organisms by as much as 1,000:1. Anaerobes are commonly found on the mucosal surfaces of the gastrointestinal tract, the genitourinary tract, and the upper respiratory tract. They are also part of the microbiota of the skin. Under normal conditions, these organisms do not cause disease. However, the heavily colonized surfaces are portals of entry into tissues and the bloodstream. When anaerobic bacteria gain access to normally sterile body sites, they can become opportunistic pathogens and cause serious, sometimes fatal, infections.

Observations such as a foul odor, gas in the specimen, and black discoloration of blood-containing exudates can provide helpful clues to the presence of an anaerobic infection. Multiple bacteria and unique bacterial morphology in direct Gram stains of clinical material can also provide presumptive evidence of the presence of anaerobes. Since most anaerobic infections arise in close proximity to mucosal surfaces, knowledge of the normal microbiota of these sites provides critical information about the presumptive identification of the infectious agents. This is important because most anaerobic infections are usually polymicrobial, with a mixture of various aerobic, facultative, and anaerobic organisms. The presence of mixed bacteria, along with the slower growth of the anaerobes, often makes isolation and identification of significant organisms a difficult and time-consuming process.

SPECIMEN COLLECTION AND TRANSPORT

Specimen collection and transport are critical factors in successful laboratory isolation of anaerobic pathogens. In general, sterile aspiration is the best method for collecting material from suspected infections with anaerobic organisms to avoid contamination with the indigenous microbiota. As an alternative, flocced and oxygen-free swabs can be used; however, the use of swabs should be avoided whenever possible.

Immediately after a specimen is collected for anaerobic culture, it is important to provide protection from the lethal effects of oxygen during transport. Several options are available. Due to safety concerns, aspirates should not be left in the syringe but, rather, should be injected into an oxygen-free transport vial or tube, such as in the method using prerduced anaerobically sterilized (PRAS) media, developed by R. E. Hungate. Similar products, as well as various anaerobic swabs and anaerobic transport systems, are also commercially available. Agar gel transport swabs (Copan Diagnostics, Murrieta, CA) and the BD BBL Vacutainer anaerobic specimen collector (Becton, Dickinson and Company, Franklin Lakes, NJ) can be used for both specimen collection and transport. Regardless of the collection method or the transport system used, specimens for anaerobic culture should be sent to the laboratory for processing as soon as possible and should be cultured within 24 h for optimal recovery.

DIRECT DETECTION

Since the majority of anaerobic infections are polymicrobial and most anaerobes grow more slowly than aerobic and facultative bacteria, identification of anaerobic organisms is typically a laborious process, and culture results are frequently delayed. Therefore, direct examination methods, such as assessing gross appearance (purulence, necrosis, or sulfur granules), odor (fetid or putrid), and fluorescence under long-wave (366-nm) UV light and Gram staining (unique anaerobic morphology), can provide valuable clues to the presence of anaerobes.

Direct Gram staining of clinical material is one of the most important diagnostic procedures for the detection of anaerobes. It provides rapid, semiquantitative information about the relative amounts and types of organisms present in the specimen. Identification of multiple distinct morphotypes observed on the direct Gram stain is strong presumptive evidence of a mixed anaerobic infection. In some instances, it is possible to provide a presumptive anaerobic identification based on the Gram stain appearance. Anaerobic, Gram-negative bacilli frequently stain faintly and irregularly with the conventional Gram stain method and thus can easily be overlooked when the smear is read. To enhance visualization of the Gram-negative anaerobes, use of a modified Gram stain procedure, in which carbol fuchsin is used instead of safranin, is recommended. Since many clinically significant anaerobes have distinct microscopic morphologies, when the specimen source is correlated with the Gram stain result, it is possible to provide information that can serve as a guide to successful empirical therapy. For example, if large, boxcar-shaped, Gram-positive bacilli with blunt ends are seen in the direct Gram stain of a specimen from an abdominal wound, one would suspect the presence of *Clostridium perfringens*, and the appropriate antimicrobial agent for this anaerobe can be selected. Refer to Table 27-1 for the characteristic Gram stain morphology of common anaerobes isolated from clinical specimens.

SPECIMEN PROCESSING

Ideally, media used to culture anaerobes should never be exposed to oxygen, in order to avoid the production of toxic substances from the reduction of molecular oxygen. PRAS medium (Anaerobe Systems, Morgan Hill, CA) is made without exposure to oxygen, thus enhancing the recovery of anaerobes. As an alternative, primary anaerobic plates can be prerduced in an anaerobic jar

Table 27-1 Characteristics of anaerobes based on Gram stain morphology

Organism	Gram stain reaction and morphology
<i>Actinomyces</i> spp.	Branching, Gram-positive bacilli
<i>Clostridium perfringens</i>	Large, Gram-positive bacilli with blunt ends (boxcar shaped), oval spores that swell the cell but are rarely seen
<i>Clostridium tetani</i>	Gram-positive bacilli with round or oval terminal spores (drumstick or tennis racket shaped)
<i>Propionibacterium</i> spp.	Small, thin, pleomorphic, Gram-positive bacilli
<i>Bacteroides</i> , <i>Porphyromonas</i> , and <i>Prevotella</i> spp.	Faintly staining, Gram-negative coccobacilli
<i>Fusobacterium nucleatum</i>	Thin, Gram-negative bacilli with tapered ends
<i>Fusobacterium necrophorum</i> or <i>Fusobacterium mortiferium</i>	Extremely pleomorphic, thin, Gram-negative bacilli with bizarre shapes
<i>Veillonella</i> spp.	Very small, Gram-negative cocci with a tendency to clump

or chamber for at least 24 h before use. For optimal recovery, media should be as fresh as possible. Growth is delayed and longer incubation is required when fresh media are not used.

Specimens from most anaerobic infections contain both facultative and anaerobic bacteria; therefore, a combination of enriched, selective, and differential media should be included in the primary media setup to optimize growth, isolation, and presumptive identification of anaerobes. The following media are recommended: brucella blood agar or CDC anaerobe blood agar containing vitamin K₁ and hemin, bacteroides bile esculin agar, kanamycin–vancomycin–laked-blood agar, and phenylethyl alcohol agar. Since thioglycolate broth supports the growth of both aerobic and anaerobic bacteria, it has limited value and serves primarily as a backup culture medium. For special situations, additional media such as egg yolk agar or cycloserine-cefoxitin-fructose agar can also be included in the primary isolation setup. Table 27-2 lists some recommended media and their use in the isolation of anaerobes from clinical specimens.

Anaerobic specimens should be processed in the laboratory as soon as possible by inoculating the appropriate media and immediately placing the inoculated plates in an oxygen-free environment at 35°C. Culture techniques include the use of anaerobic jars, anaerobic bags or pouches, and anaerobic chambers. The jars, bags, and

Table 27-2 Recommended media for anaerobic culture

Medium	Purpose
Primary isolation	
Brucella blood agar (BRU) (acceptable alternatives: CDC anaerobe blood agar, Schaedler blood agar, and enriched brain heart infusion blood agar)	Enriched with vitamin K ₁ and hemin; nonselective; isolation of obligate and facultative anaerobes
Bacteroides bile esculin agar (BBE)	Selective and differential: gentamicin inhibits most aerobic organisms, 20% bile inhibits most anaerobes, and hydrolysis of esculin turns the medium brown; rapid isolation and presumptive identification of members of the <i>Bacteroides fragilis</i> group
Kanamycin–vancomycin–laked-blood agar (KVLB) (acceptable alternatives: kanamycin–vancomycin blood agar or paromomycin–vancomycin blood agar)	Selective: kanamycin inhibits most facultative, Gram-negative bacilli; vancomycin inhibits most Gram-positive organisms as well as <i>Porphyromonas</i> spp.; and laked blood allows early detection of pigmented <i>Prevotella</i> spp., often within 48 h
Phenylethyl alcohol agar (PEA)	Permits growth of both Gram-positive and Gram-negative anaerobes while inhibiting most <i>Enterobacteriaceae</i> , including swarming <i>Proteus</i>
Thioglycolate broth (THIO)	Backup only
Special situations	
Cycloserine-cefoxitin-fructose agar (CCFA)	Selective and differential: used for the recovery and presumptive identification of <i>Clostridioides</i> (formerly <i>Clostridium</i>) <i>difficile</i>
Egg yolk agar (EYA)	Differential: used when <i>Clostridium</i> spp. are suspected (lecithinase and lipase reactions)

pouches consist of a gas-impermeable container, a gas generator, and an indicator. When the generator is opened, carbon dioxide and hydrogen are produced. The hydrogen then combines with the oxygen to form water, and a carbon dioxide-rich environment is created. The use of an indicator such as methylene blue, which is blue when oxidized and white when reduced, verifies that the proper anaerobic atmosphere has been achieved and maintained. Due to high cost, space limitations, and lack of specimen volume, most clinical laboratories do not use anaerobic chambers. However, if proper specimen collection, transport, and processing have been observed, recovery of the clinically significant anaerobes appears to be comparable by all methods. Anaerobes are most susceptible to oxygen exposure during their log phase of growth; therefore, anaerobic plates should be incubated for 48 h before initial examination. Negative cultures should be held for a minimum of 7 days.

IDENTIFICATION OF ANAEROBIC BACTERIA

Although identification of anaerobic bacteria is a labor-intensive process, preliminary grouping of anaerobes can be made by Gram staining and by observing colony morphology and susceptibility to special-potency antimicrobial disks. The three disks commonly used are vancomycin (5 µg), kanamycin (1 mg), and colistin (10 µg). A zone of

inhibition of >10 mm is considered to indicate susceptibility for identification purposes. Refer to Table 27-3 for presumptive identification of anaerobes based on results obtained with special-potency antimicrobial disks. The vancomycin and colistin disks can also serve as an aid to determine the Gram reaction for anaerobic organisms that are easily overdecolorized. In general, Gram-positive bacteria are susceptible to vancomycin and resistant to colistin, whereas Gram-negative organisms are resistant

Table 27-3 Presumptive identification of anaerobes based on special-potency antimicrobial disk results

Organism	Result ^a with disk containing:		
	Kanamycin (1 mg)	Vancomycin (5 µg)	Colistin (10 µg)
<i>Bacteroides fragilis</i> group	R	R	R
<i>Campylobacter ureolyticus</i>	S	R	S
<i>Fusobacterium</i> spp.	S	R	S
<i>Porphyromonas</i> spp.	R	S	R
<i>Veillonella</i> spp.	S	R	S
<i>Peptostreptococcus anaerobius</i>	R ^s	S	R
Other anaerobic, Gram-positive cocci	S	S	R
Anaerobic, Gram-positive bacilli	V	S ^b	R

^aR, resistant; S, susceptible; R^s, resistant, rarely susceptible; V, variable reaction.

^bRare *Lactobacillus* spp. and *Clostridium* spp. may be vancomycin resistant.

to vancomycin. Other characteristics include hemolysis, pigment production, fluorescence, and simple tests such as those for indole, nitrate, and catalase, which can provide a presumptive identification of several clinically significant anaerobes. For definitive identification, a wide variety of products are available. They range from rapid minisystems to conventional PRAS biochemical tubes. In

some instances, analysis of metabolic end products or cellular fatty acids may also be required. Matrix-assisted laser desorption ionization-time of flight mass spectrometry and nucleic acid techniques have been introduced as alternative approaches to identify anaerobes. Nucleic acid sequencing, in particular of the 16S rRNA, has proven useful.

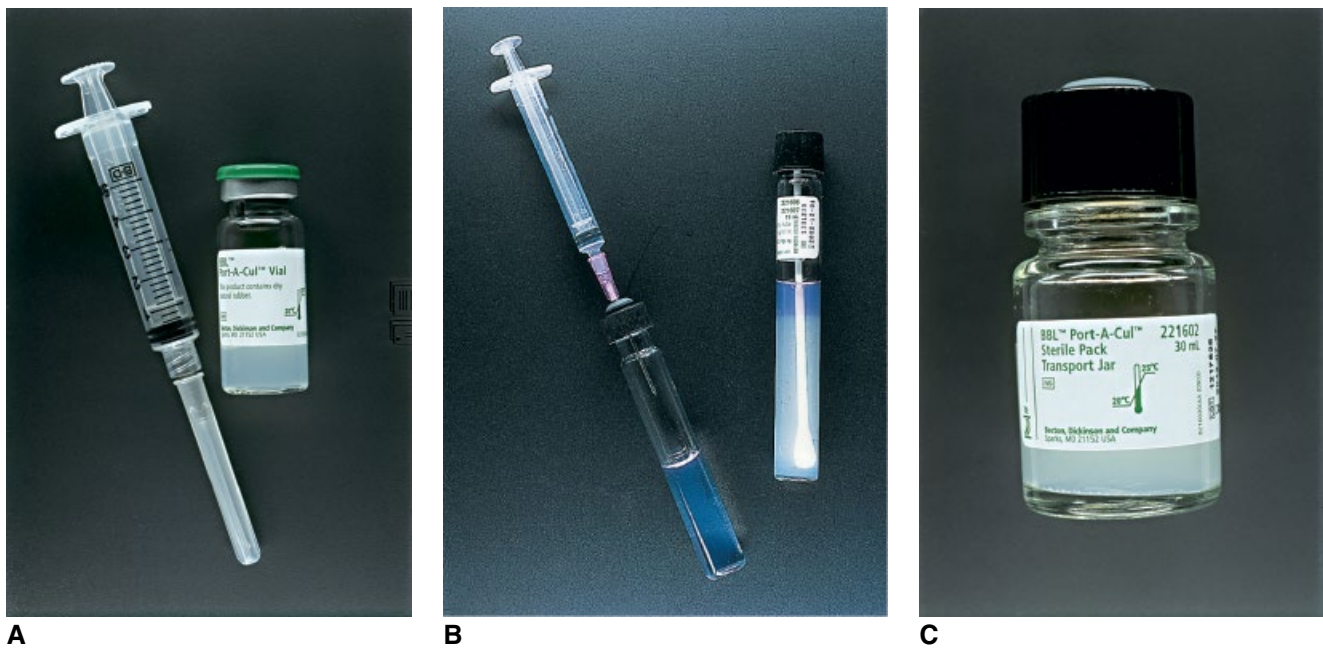


Figure 27-1 Anaerobic collection and transport. In general, the preferred method of obtaining material for anaerobic culture is by aspiration using a needle and syringe. An alternative collection method is the use of swabs. A variety of products are available to transport specimens and maintain viability of anaerobic organisms once the specimen is collected. (A) The Port-A-Cul vial (BD BBL, Franklin Lakes, NJ) is used for fluid specimens, which are injected through the septum onto the solid agar surface. (B) Two similar products can be used to transport fluids, tissues, or specimens collected with a swab. As shown on the right, a swab specimen can be inserted directly into the Port-A-Cul tube. Note the color change of the resazurin indicator at the top of the prerduced agar as a result of the oxidation of the medium when the screw cap is removed and the swab is inserted. The vial containing PRAS anaerobic transport medium (Anaerobe Systems, Morgan Hill, CA), shown on the left, has a screw cap containing a rubber septum. This allows direct injection of aspirated material, thus avoiding oxidation. Small tissue samples and specimens collected using a swab can also be transported by removing the cap and inserting the specimen into the semisolid agar. (C) The Port-A-Cul transport jar (BD BBL) has a wide mouth with a screw cap, which allows larger tissue or biopsy specimens to be directly inserted into the reduced holding medium.

Figure 27-2 ESwab collection and transport system. ESwab (Copan Diagnostics Inc., Murrieta, CA) is a self-contained, liquid-based collection and transport system consisting of a nylon-flocked swab and 1 ml of modified liquid Amies medium. After specimen collection, the swab is placed in the tube, the applicator shaft is snapped, and the lid is screwed on tightly. The sample immediately elutes into the liquid medium, which allows automated liquid handling. Aerobic, anaerobic, and fastidious bacteria maintain viability in ESwab for up to 48 h at room and refrigerator temperatures.



Figure 27-3 Anaerobic environment with the GasPak EZ gas-generating pouch system with indicator. The GasPak EZ gas-generating pouch system (BD Diagnostic Systems, Franklin Lakes, NJ) consists of a resealable pouch and a gas-generating sealed-reagent sachet, which becomes activated when removed from the outer wrapper. This system is convenient for the primary setup of anaerobic specimens or when only a small number of plates are inoculated. After the plates are inoculated and placed in the bag along with activated sachet, the pouch is tightly sealed by pressing the zipper together. Carbon dioxide and hydrogen are released from the generator, producing an anaerobic environment. To ensure that anaerobic conditions have been maintained, the indicator is included and should remain white throughout the incubation.

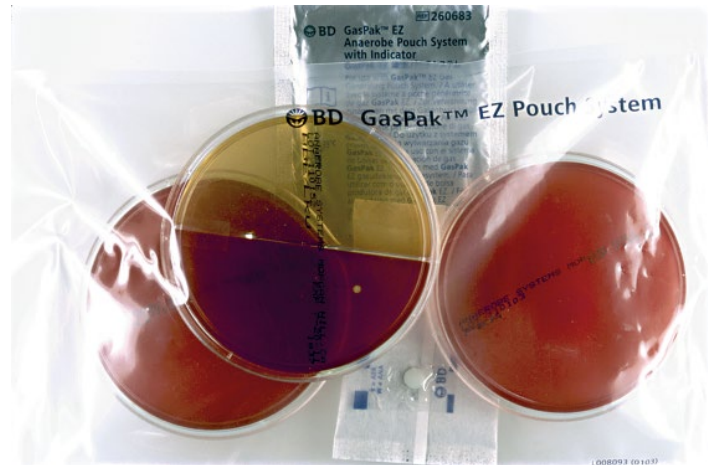
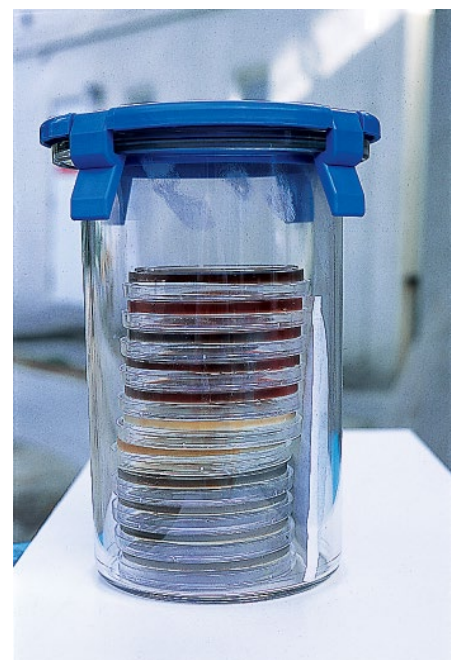


Figure 27-4 Anaerobic jar. Many types of anaerobic jars are commercially available. The standard round jar (EM Science, Gibbstown, NJ) can accommodate up to 12 plates and is commonly used in many laboratories. Inoculated plates are placed in the jar along with a gas-generating envelope and indicator strip. The container is sealed, and carbon dioxide and hydrogen are released from the envelope to produce anaerobic conditions.



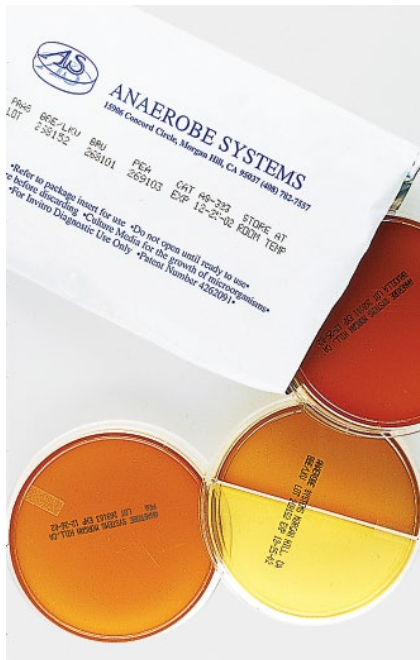


Figure 27-5 PRAS plated medium. PRAS medium is manufactured, packaged, shipped, and stored under anaerobic conditions. The primary anaerobic medium pack shown here (Anaerobe Systems) contains enriched, selective, and differential media and includes brucella blood agar, phenylethyl alcohol agar, and a biplate with bacteroides bile esculin agar and kanamycin–vancomycin–laked-blood agar. The plates are stored in a gas-impermeable foil pouch, which is opened at the time of specimen inoculation.



Figure 27-6 Growth of mixed aerobic and anaerobic organisms on primary media. Anaerobes are usually present in mixed culture. The combination of enriched, selective, and differential media included in the primary setup aids in evaluating cultures for the presence of anaerobes and may also provide a preliminary identification of anaerobic organisms. The culture shown is from a mixed infection with both aerobic and anaerobic bacteria. The brucella blood agar (top) is enriched and supports the growth of facultative and anaerobic bacteria, while the phenylethyl alcohol agar plate (bottom right) is selective and inhibits the growth of most members of the *Enterobacteriales*. A preliminary identification of the *Bacteroides fragilis* group can be made based on the growth on kanamycin–vancomycin–laked-blood agar and bacteroides bile esculin agar and on the hydrolysis of esculin (biplate on the bottom left). Esculin hydrolysis by the *B. fragilis* group produces esculetin and dextrose. The esculetin reacts with the ferric ammonium citrate present in the medium, producing a dark brown to black complex. Note the browning of the medium around the colonies on the bacteroides bile esculin agar.

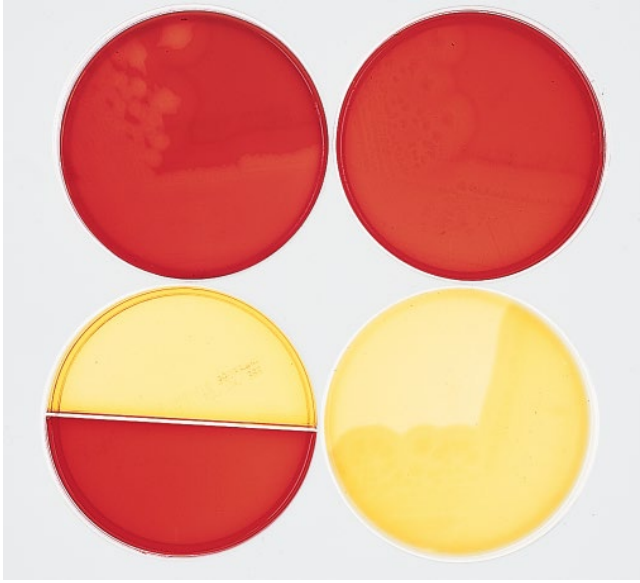


Figure 27-7 Egg yolk agar. When the Gram stain of a specimen shows the presence of leukocytes and large, Gram-positive bacilli, suggesting a clostridial infection, egg yolk agar (EYA) should be included in the primary anaerobic media. Colony morphology, Gram reaction, and a positive lecithinase and/or lipase reaction can provide a rapid presumptive identification of some common clostridia. In the culture shown, note the double zones of beta-hemolysis on the brucella blood agar (top left) and the positive lecithinase reaction (opacity) on EYA (bottom right). (Top right) Alcohol-agar plate; (bottom left) kanamycin–vancomycin–laked-blood agar and bacteroides bile esculin agar biplate. The characteristic hemolysis and EYA reaction, along with the Gram stain and morphology, provide a presumptive identification of *Clostridium perfringens*.

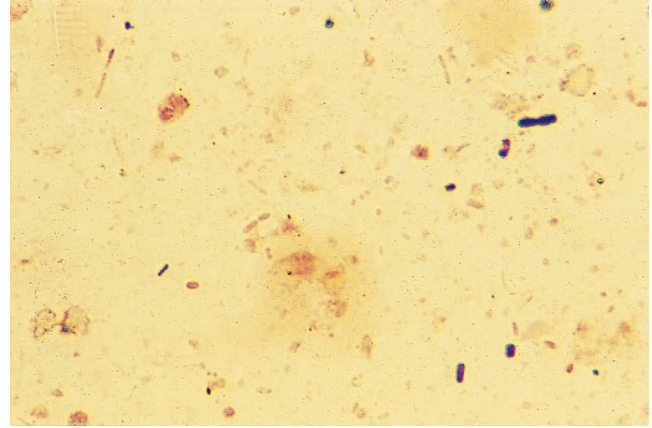
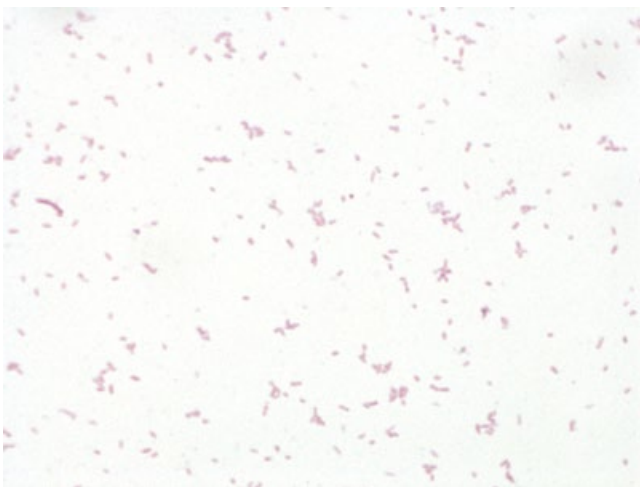
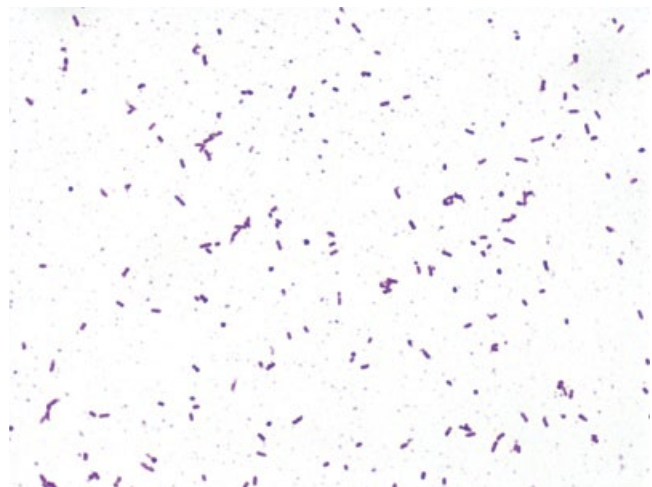


Figure 27-8 Gram stain of a mixed infection with suspected anaerobes. Most anaerobic infections are polymicrobial and include both aerobic and anaerobic organisms. In this Gram stain of a specimen from a foot abscess, multiple distinct morphotypes are present. From the appearance of this Gram stain, there is strong presumptive evidence that anaerobes are present in this specimen. Note the large, Gram-positive bacilli and the faintly staining Gram-negative bacilli. The culture grew *Escherichia coli*, *Enterobacter* spp., anaerobic Gram-negative bacilli, and a *Clostridium* sp.



A



B

Figure 27-9 Gram stain of *Bacteroides fragilis*. In a Gram stain with safranin as the counterstain, Gram-negative, anaerobic bacteria stain faintly and can be overlooked in direct smears of clinical specimens or in blood cultures. (A) Safranin was used as the counterstain in this Gram stain of a blood culture. The Gram-negative bacilli are difficult to see. (B) Carbol fuchsin was used as the counterstain, and the organism appears more prominent. *B. fragilis* was isolated from this blood culture.

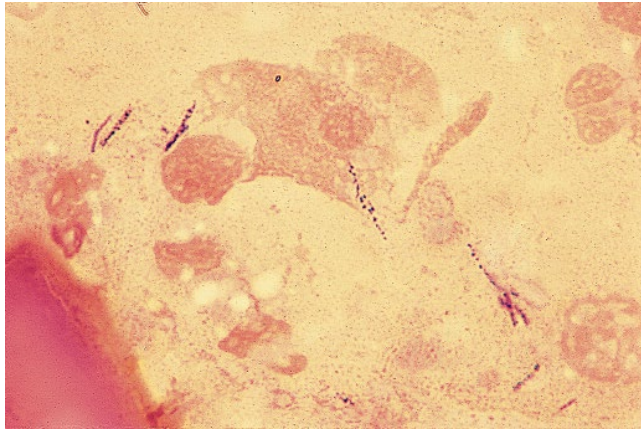


Figure 27-10 Gram stain of *Actinomyces israelii*. Branching, filamentous bacilli are typical of an *Actinomyces*-like organism. *Actinomyces* spp. are Gram positive; however, their irregular staining may cause a beaded or banded appearance. *A. israelii* was isolated from this culture.

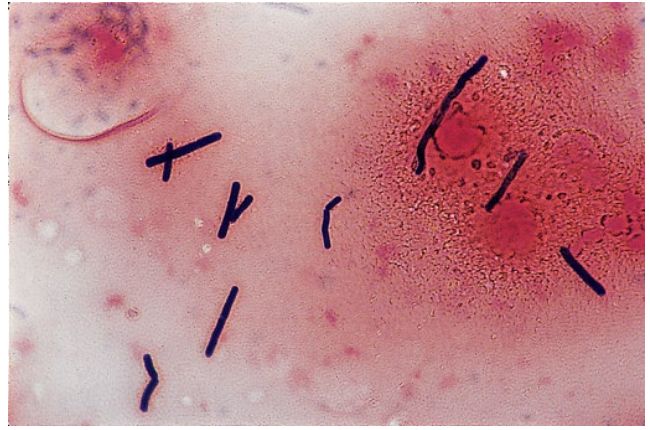


Figure 27-11 Gram stain of *Clostridium perfringens*. This Gram stain of a positive blood culture shows large, boxcar-shaped, Gram-positive bacilli without spores, which is typical of *C. perfringens*. Although rare, *C. perfringens* may have oval spores that swell the cell. Cells can occur singly or in pairs and are 0.6 to 2.4 μm by 1.3 to 19.0 μm .



Figure 27-12 Gram stain of *Fusobacterium nucleatum*. As shown here, *F. nucleatum* organisms appear as thin, Gram-negative bacilli that are 0.4 to 0.7 μm by 3 to 10 μm and have tapered or pointed ends.

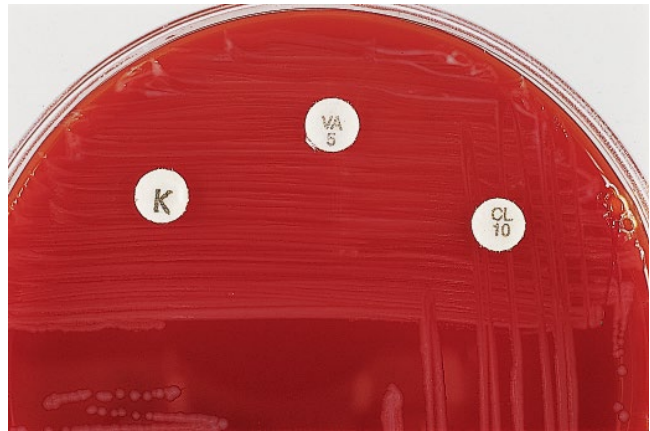


Figure 27-13 Disk pattern of the *Bacteroides fragilis* group. Special-potency antibiotic disks can be used to aid in the preliminary grouping of anaerobes and can also serve as a check for the appropriate Gram reaction. In general, Gram-negative organisms are resistant to vancomycin, while Gram-positive organisms are susceptible to vancomycin and resistant to colistin. As shown, the *B. fragilis* group is resistant to all three of the antibiotics: kanamycin (1 mg), vancomycin (5 μg), and colistin (10 μg).

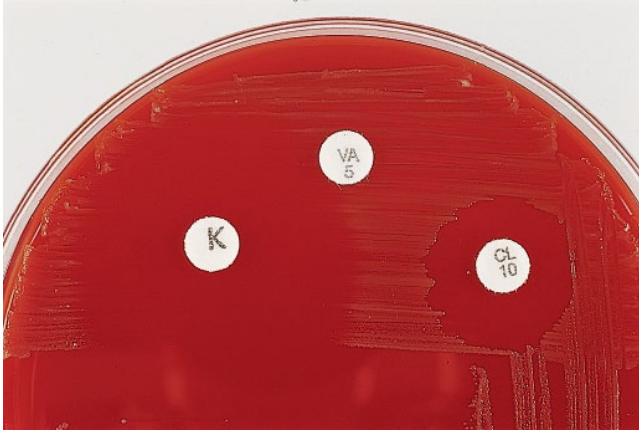


Figure 27-14 Disk pattern of *Fusobacterium* spp. The disk pattern shown, kanamycin and colistin susceptible and vancomycin resistant, is typical of *Fusobacterium* spp.

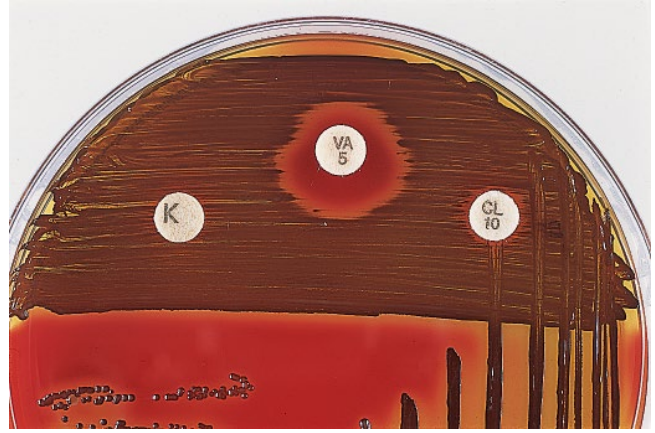


Figure 27-15 Disk pattern of *Porphyromonas* spp. Unlike other Gram-negative organisms, *Porphyromonas* spp. are susceptible to vancomycin. The organism shown here is kanamycin and colistin resistant (with a zone of inhibition <10 mm in diameter) but vancomycin susceptible, which is characteristic of *Porphyromonas* spp.

Figure 27-16 Disk pattern of *Clostridium* spp. Although some clostridia stain Gram negative, the disk pattern is consistent with a Gram-positive organism and confirms the correct Gram reaction of the isolate. As shown here, clostridia are vancomycin and kanamycin susceptible and colistin resistant.



Figure 27-17 Disk pattern of *Veillonella* spp. Although *Veillonella* spp. are Gram-negative cocci, they can retain some of the crystal violet stain and appear Gram variable. However, their disk pattern, as shown here, is consistent with that of a Gram-negative organism. They are vancomycin resistant and kanamycin and colistin susceptible.





Figure 27-18 Biochemically based minisystem for identification of anaerobic organisms. There are several commercially available systems for the identification of anaerobic organisms. The API 20A (bioMérieux, Inc., Durham, NC) was one of the first alternatives to conventional tube media and uses many of the same tests. A bacterial suspension equivalent to a no. 3 McFarland standard is prepared and used to inoculate the strip, which consists of 20 microtubes. The strip is then incubated anaerobically at 35°C for 24 to 48 h, depending on the growth rate of the anaerobic organism. Similar to other API products, the 20A, along with the catalase reaction and three morphological characteristics (presence of spores, Gram reaction, and morphology), creates a numerical profile that is used to identify the organism. The organisms shown are *Clostridium perfringens* (top) and *Bacteroides fragilis* (bottom).



Figure 27-19 Preexisting enzyme-based minisystem for anaerobic identification. The Rapid ANA II (Thermo Scientific, Waltham, MA) is a minisystem employing both conventional and chromogenic substrates for the identification of clinically significant anaerobes. The test is based on the presence of preexisting enzymes and does not require growth of the organism. A bacterial suspension equivalent to a no. 3 McFarland standard is prepared and used to inoculate the panel, which is then incubated aerobically at 35°C for 4 h. The panel contains 10 reaction wells, 8 of which are bifunctional (containing 2 separate tests in the same well), thereby providing a total of 18 tests. To provide both test results, the bifunctional tests are read before and again after the addition of reagents. The organisms shown are *Clostridium perfringens* (top) and *Bacteroides fragilis* (bottom).

Clostridium and *Clostridioides*

28

The genus *Clostridium* includes 240 species of obligately anaerobic, Gram-positive bacilli that have the capacity to form endospores. *Clostridium* spp. are ubiquitous in nature, widely distributed in soil, and frequent inhabitants of the intestinal tract, but the number of species associated with human infections is limited. Some of the most common *Clostridium* spp. isolated from human specimens are *Clostridium perfringens*, *Clostridium botulinum*, *Clostridium clostridioforme* (now subdivided into three species: *Clostridium bolteae*, *Clostridium clostridioforme*, and *Clostridium hathewayi*), *Clostridium innocuum*, *Clostridium ramosum*, *Clostridium butyricum*, and *Clostridium cadaveris*. The new genus *Clostridioides* contains two species, *Clostridioides difficile* (prior designation *Clostridium difficile*) and *Clostridioides mangenotii*. The characteristics of these and other *Clostridium* and *Clostridioides* spp. are outlined in Table 28-1.

C. perfringens is the species most frequently isolated from clinical specimens and causes a variety of infections, including the majority of clostridial bacteremias (79%). Like other *Clostridium* spp., such as *Clostridium novyi*, *Clostridium septicum*, and *Clostridium histolyticum*, this organism produces alpha-toxin, which may result in myonecrosis (gas gangrene), a life-threatening condition. *C. perfringens* type A is associated with foodborne gastroenteritis that often results from eating improperly cooked meat or meat products. Diarrhea and abdominal cramps usually appear 7 to 15 h after ingestion of the contaminated food as a result of the enterotoxin (*C. perfringens* enterotoxin, CPE) produced by the organism. *C. perfringens* type C may be part of the normal microbiota. However, *C. perfringens* type C

strains that produce alpha-toxin and beta-toxin can cause enteritis necroticans, a severe disease of the small bowel that usually occurs in children. Necrotizing enterocolitis is a very severe disease that mainly affects premature, low-birth-weight infants. The intestinal wall is invaded by bacteria, which results in severe inflammation that destroys the bowel. Several gas-producing organisms have been associated with necrotizing enterocolitis, including *C. perfringens*, *Clostridium neonatale*, and *C. butyricum*, but so far the etiological agent is unknown. *C. sordellii* and *C. perfringens* have been associated with toxic shock syndrome and abortion.

Clostridioides difficile is the cause of antibiotic-associated diarrhea and pseudomembranous colitis. This organism is part of the normal microbiota in 30% of neonates. Carriage rates range from 3 to 5% in healthy adults but increase to 20 to 30% in sedentary patients. Both nontoxigenic and toxigenic strains can be found in the hospital environment. However, only isolates that carry the pathogenicity locus (PaLoc) contain the genes coding for the enterotoxin TcdA (toxin A) and the cytotoxin TcdB (toxin B). Some strains produce only toxin B. Both toxins appear to be important in pathogenesis and can induce cytopathic effects in cell culture. Two proteins, TcdR and TcdC, whose genes are located in the PaLoc regulate the expression of the toxins. The *tcdC* gene is shortened in endemic hypervirulent ribotype 027/NAP1 (North American pulsotype 1) isolates. These strains may overproduce toxins that lead to more severe *C. difficile* infection (CDI). A third toxin, binary toxin (CDT), located outside the PaLoc, has also been associated with increased severity of CDI.

Table 28-1 Characteristics of *Clostridium* and *Clostridioides* spp.

Organism	Colony morphology	Gram stain and spores	Other characteristic(s)
Group 1: saccharolytic, proteolytic			
<i>Clostridium bifermentans</i>	Gray-white; scalloped edge; chalk-white colonies on egg yolk agar	Gram-positive bacilli often in chains; subterminal spores and many free spores	Indole positive, lecithinase positive, urease negative
<i>C. botulinum</i>	Gray-white; irregular; usually beta-hemolytic	Gram-positive bacilli singly or in pairs; oval, subterminal spores cause swelling of the cells	
<i>C. cadaveris</i>	White-gray; entire or slightly irregular and raised	Gram-positive bacilli; oval terminal spores	Spot indole positive, DNase positive
<i>C. perfringens</i>	Gray-yellow; circular; entire; glossy; translucent with double zone of beta-hemolysis	Gram-positive, boxcar-shaped bacilli, singly or in pairs; central to subterminal, oval spores that swell the cell but are rarely seen	Lecithinase positive, reverse CAMP positive
<i>C. septicum</i>	Gray, translucent; swarms like Medusa heads; beta-hemolytic	Pleomorphic, Gram-positive bacilli; may produce long filaments and turn Gram-negative in old cultures; rare spores are oval and subterminal, swelling the cell	Sucrose negative, DNase positive
<i>C. sordellii</i>	Large; gray-white; scalloped edge	Large, Gram-positive bacilli; subterminal or free spores, often in chains	Indole positive, lecithinase positive, urease positive
<i>C. sporogenes</i>	Medusa head shape; may swarm	Gram-positive bacilli; abundant oval, subterminal spores and many free spores	Lipase positive, esculin hydrolysis positive
<i>Clostridioides difficile</i>	Creamy yellow-gray-white; irregular; coarse or mosaic internal structure; fluoresces chartreuse on cycloserine-cefoxitin-fructose agar, <i>C. difficile</i> selective agar, and CDC agar under UV light	Straight, Gram-positive bacilli often in short chains; rare oval, subterminal spores and free spores	Weakly mannitol positive, esculin hydrolysis positive, horse stable odor
Group 2: saccharolytic, nonproteolytic			
<i>Clostridium baratii</i>	Double zone of hemolysis	Boxcar-shaped bacilli; rare spores	Lecithinase positive
<i>C. butyricum</i>	Large; irregular; mottled to mosaic internal structure	Gram-positive bacilli; subterminal spores	Ferments many carbohydrates
<i>C. clostridioforme</i>	Small; convex; entire edge; irregular; greening of agar around colonies	Long, thin, Gram-negative bacilli; tapered ends; spores are rare	Lactose positive, β -N-acetylglucosaminidase negative
<i>C. glycolicum</i>	Gray-white; entire to scalloped edge; convex	Gram-positive bacilli; subterminal and free spores	DNase positive
<i>C. innocuum</i>	Gray-white to brilliant greenish colonies; mosaic internal structure	Gram-positive bacilli; rare terminal spores may be difficult to find	Mannitol positive, lactose negative, maltose negative, nonmotile
<i>C. ramosum</i>	Resembles <i>Bacteroides fragilis</i> but usually has a slightly irregular edge	Gram-variable, palisading, slender bacilli; spores are rare, round or oval, and terminal	Mannitol positive, nonmotile
<i>C. tertium</i>	White-gray; irregular margins	Gram variable with terminal spores when incubated anaerobically	Aerotolerant
Group 3: asaccharolytic			
<i>Clostridium tetani</i>	Gray, translucent; irregular to rhizoid; may form a film over entire agar surface; narrow zone of beta-hemolysis	Gram-positive cells that turn Gram negative after 24 h in culture; singly or in pairs; spores oval and terminal with tennis racket or drumstick appearance	

C. botulinum produces seven different types of neurotoxin. Types A, B, E, and F are the principal causes of botulism in humans. Four categories of clinical botulism are currently recognized: (i) foodborne botulism, resulting from the ingestion of preformed toxin; (ii) wound botulism, resulting from the production of toxin by *C. botulinum* growing in the wound; (iii) infant botulism, in which the toxin is formed by *C. botulinum* colonizing the intestinal tract (in these cases, breast-feeding and ingestion of honey are potential sources of the spores); and (iv) botulism due to colonization of the intestine in older children and adults. Other forms include iatrogenic botulism, due to injection of botulinum toxin in cosmetic procedures, and botulism in which the route of transmission is unknown.

Tetanospasm, the toxin elaborated by *Clostridium tetani*, is the cause of the clinical manifestations of tetanus. This toxin usually enters the body through a wound and binds to components of the neuroexocytotic apparatus, blocking inhibitory impulses to the motor neurons. As a result, *C. tetani* produces spastic paralysis, in contrast to *C. botulinum*, which produces flaccid paralysis. One million cases of tetanus, resulting in approximately 35,000 deaths of newborns, are estimated to have occurred in 2015. Tetanus can be prevented with a vaccine.

Bacteremia due to *C. septicum* is commonly associated with neoplasias, particularly colon and breast cancer, leukemia, and lymphoma. Patients infected with this organism are also frequently neutropenic, and it is very important to diagnose this infection rapidly in order to implement adequate therapy, since mortality rates are very high. The ileocecal region of the intestinal tract appears to be the portal of entry for this bacterium into the blood. *Clostridium tertium* can also cause bacteremia in patients with malignancies, acute pancreatitis, and neutropenic enterocolitis. In cases of suspected enterocolitis with myonecrosis due to *C. septicum*, cultures of blood, feces, and a tissue biopsy specimen should be submitted for diagnosis. *Clostridium paraputrificum* has been isolated from blood in patients with underlying medical conditions including AIDS, diabetes, malignancies, and sickle cell anemia.

Anaerobic methods should be used for specimen collection, transportation, and storage of these bacteria when *Clostridium* spp. are suspected. Collection of tissue specimens from several sites is recommended for culture, and direct examination of the specimen by Gram stain is important for a rapid presumptive clinical diagnosis. For the foodborne diseases produced by *C. perfringens*, specimens should be referred to a public health laboratory. In the case of suspected *C. botulinum*

infection, the local or state health department or Centers for Disease Control and Prevention should be immediately notified and the appropriate specimens should be submitted for culture and toxin determination.

A nonformed stool specimen is recommended for diagnosis of CDI. Testing should be performed only on stool specimens from patients with diarrhea, because 5 to 10% of the normal population are asymptomatic carriers of the toxigenic strains. In asymptomatic individuals carrying a toxigenic *C. difficile* strain, the toxin gene can be detected, but the protein is not expressed. There are three major categories of diagnostics tests: methods that detect toxin A and toxin B, which include enzyme immunoassays (EIAs) and cell culture cytotoxicity neutralization assays; culture and/or the glutamate dehydrogenase (GDH) assay, which detects an enzyme produced by *C. difficile*; and nucleic acid amplification tests (NAAT), which detect the genes that code for the toxins. Tissue culture is considered the gold standard for the detection of toxin B, but it is cumbersome and takes several days to perform. EIAs, which can detect both toxins A and B, are widely employed due to their rapidity and ease of use; however, EIAs are less sensitive and specific than tissue culture. Some EIA kits include the simultaneous detection of the *C. difficile* GDH antigen and toxins A and B. The GDH assay has high sensitivity but low specificity because it cannot distinguish toxigenic from nontoxigenic isolates. Therefore, the EIA results for both GDH and toxins A and B are necessary for final interpretation. NAAT have high sensitivity and specificity for the detection of the toxin A and B genes (*tcdA* and *tcdB*) and are rapid. The optimum testing algorithm for CDI is still controversial. However, a two-step algorithm, comprising initial testing with a NAAT or GDH assay followed by a sensitive toxin detection test, is the most widely accepted approach. As an alternative to the two-step algorithm, the Infectious Diseases Society of America and the Society for Health Care Epidemiology of America recommend NAAT alone when pretest probability is improved by preventing testing of patients on laxatives or without diarrhea.

Gas gangrene is a clinical emergency and requires immediate treatment. Therefore, a Gram stain of a wound may be extremely helpful in diagnosing cases of infections due to *Clostridium* spp. Although clostridia are commonly associated with polymicrobial abdominal microbiotas, the characteristic morphology of some species and the presence of spores are helpful in providing an initial diagnosis until culture confirmation is obtained. Typically, Gram-positive bacilli with or without spores are detected. When produced, spores can be

spherical to ovoid; are located terminally, subterminally, or centrally; and may or may not cause swelling of the cell. Most clostridia are straight or curved, Gram-positive bacilli; however, there is great variation in morphology and staining characteristics. Cells can range from 0.5 to 2.4 μm in width and 1.3 to 35 μm in length and thus can appear coccoid to filamentous with rounded, tapered, or blunt ends. Single cells, pairs, or chains of different lengths can be observed. The Gram stain characteristics of the *Clostridium* spp. most commonly isolated from clinical specimens are summarized in Table 28-1.

Most species of clostridia grow well on the anaerobic media routinely used in the clinical laboratory. Specimens should be plated on CDC anaerobe blood agar or other suitable enriched, nonselective anaerobic blood agar medium and anaerobic phenylethyl alcohol blood agar. Cycloserine-cefoxitin-fructose agar (Anaerobe Systems,

Morgan Hill, CA) is a selective and differential medium for the isolation and presumptive identification of *C. difficile*. Formation of spores can be enhanced by growing the specimen in chopped-meat broth at 30°C, except for *C. perfringens*, which sporulates better at 37°C. For specimens from wounds and abscesses, adding egg yolk agar to the routine primary media facilitates early presumptive identification of *Clostridium* species. For definitive identification, analysis of metabolic products or cellular fatty acids may be required. Matrix-assisted laser desorption ionization-time of flight mass spectrometry (MALDI-TOF MS) is currently being implemented for the identification of *Clostridium* species. However, a presumptive identification can be made for most clostridia isolated from clinical specimens based on Gram stain, colony morphology, aerotolerance, a few biochemical reactions, and characteristics on differential media.

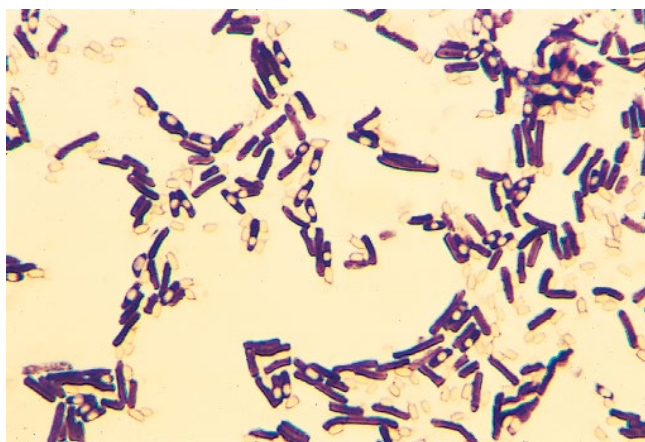


Figure 28-1 Gram stain of *Clostridium bifermentans*. *C. bifermentans* is a Gram-positive bacillus measuring 0.6 to 1.9 μm by 1.6 to 11 μm and can be found singly or in short chains. The spores are oval, do not swell the cell, and can be central or subterminal.



A



B

Figure 28-2 Culture of *Clostridium bifermentans* on CDC agar. White-gray or translucent, flat colonies with irregular scalloped margins are produced by *C. bifermentans* on CDC agar. (A) Low magnification; (B) high magnification.

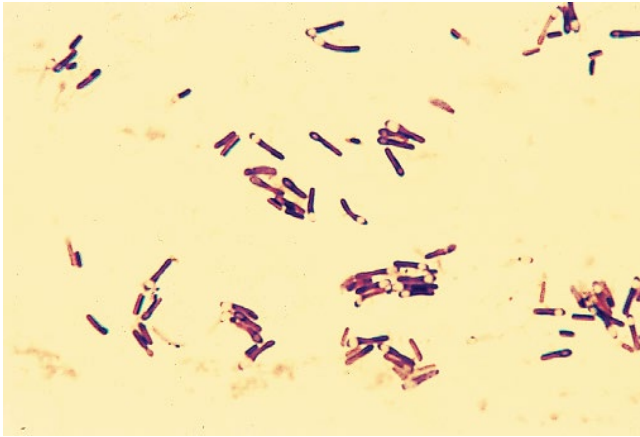


Figure 28-3 Gram stain of *Clostridium botulinum*. *C. botulinum* usually appears as single straight or curved, Gram-positive bacilli. The bacilli sporulate readily on most media and have oval, subterminal spores that cause swelling of the cells.

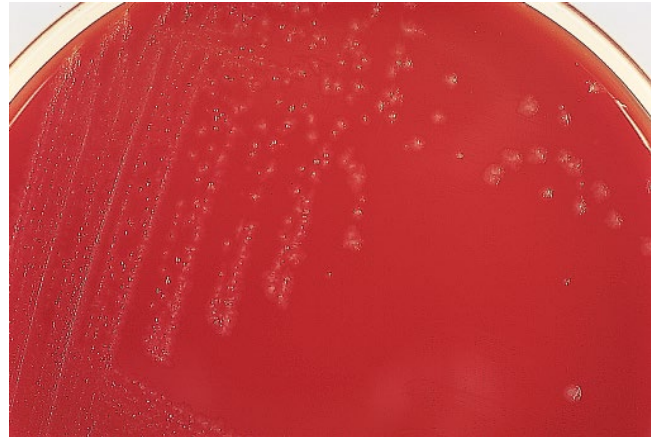
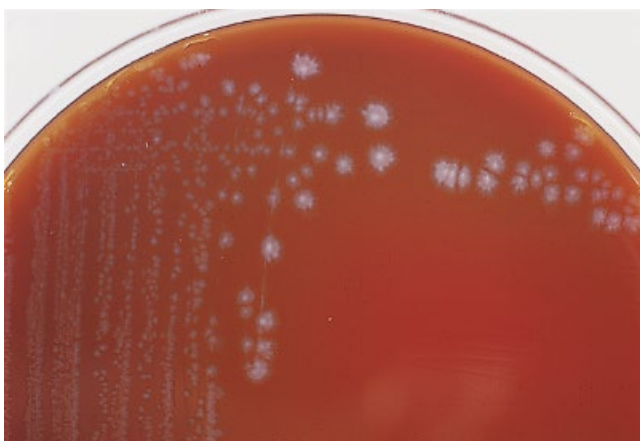
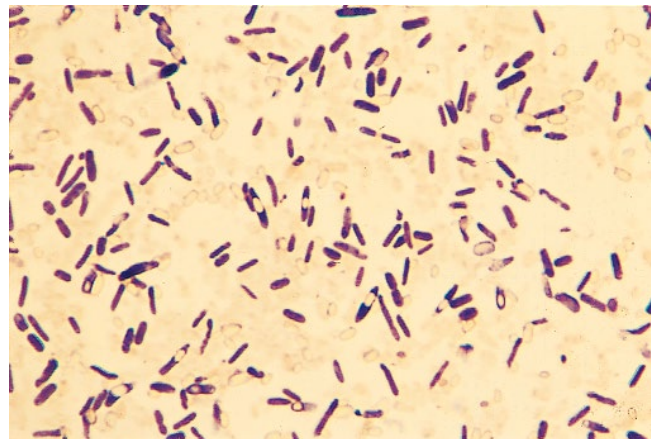
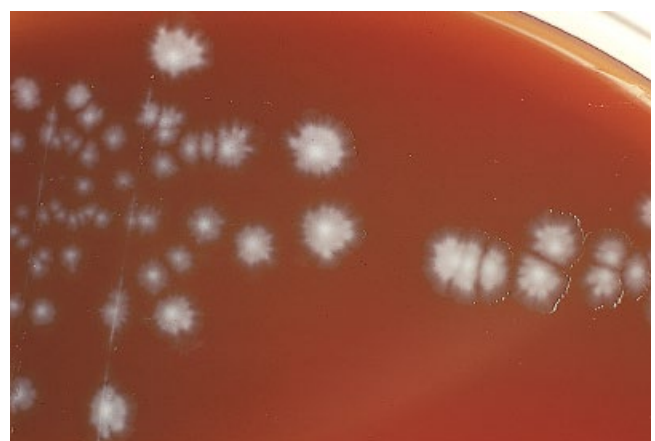


Figure 28-4 *Clostridium botulinum* on CDC agar. Colonies of *C. botulinum* are gray-white or translucent, flat or raised, and circular to irregular and have a small zone of beta-hemolysis. Phenotypically they cannot be differentiated from *Clostridium sporogenes*, and a mouse toxin neutralization assay, gel electrophoresis, or other tests are necessary for a definitive identification.

Figure 28-5 Gram stain of *Clostridium clostridioforme*. *C. clostridioforme* organisms are Gram-positive bacilli with pointed ends and central or subterminal spores that can swell the cell.



A

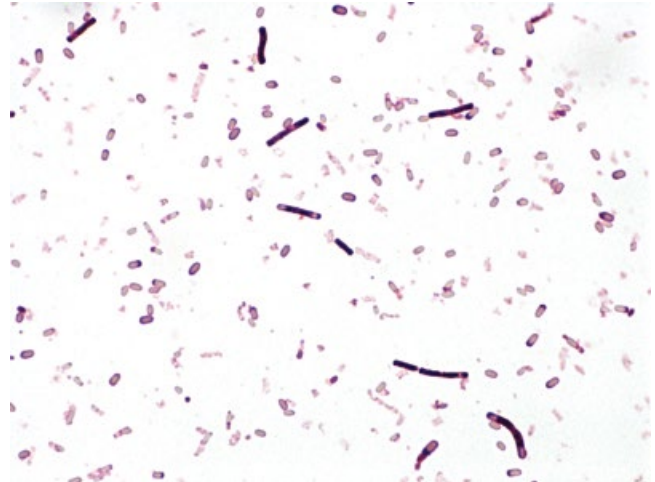


B

Figure 28-6 *Clostridium clostridioforme* on CDC agar. This organism forms nonhemolytic colonies that are white-gray with opaque centers and translucent, mottled, irregular edges. (A) Low magnification; (B) high magnification.



A

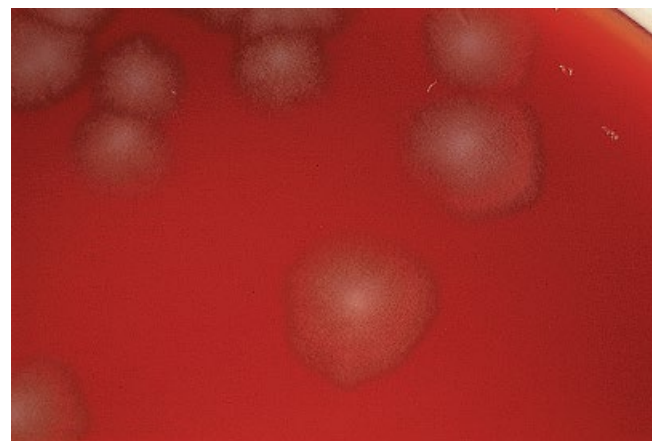


B

Figure 28-7 Gram stain of *Clostridioides difficile*. (A) *C. difficile* is a straight, Gram-positive bacillus that measures 0.5 to 2.0 μm by 3 to 15 μm and often forms short chains aligned end to end. (B) *C. difficile* can produce spores that are oval and subterminal and cause swelling of the cells.



A



B

Figure 28-8 *Clostridioides difficile* on CDC agar. Colonies of *C. difficile* are gray to white, opaque, matte to glossy, flat, round, occasionally rhizoid, and nonhemolytic. They have a distinctive odor commonly described as “horse manure.” (A) Low magnification; (B) high magnification.

Figure 28-9 *Clostridioides difficile* on CDC agar, examined under UV light. As shown here, colonies of *C. difficile* fluoresce chartreuse (yellow-green) under UV light.

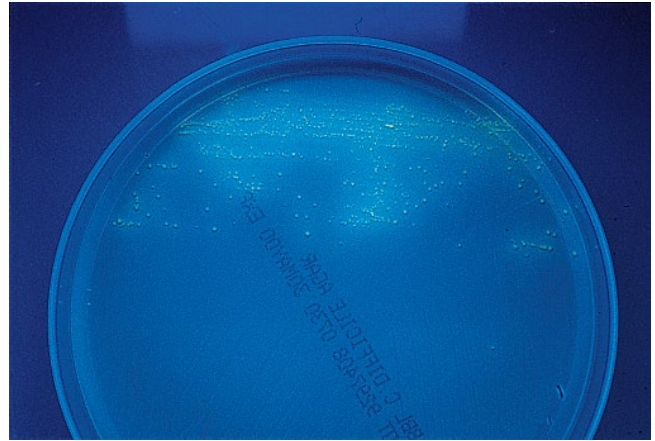
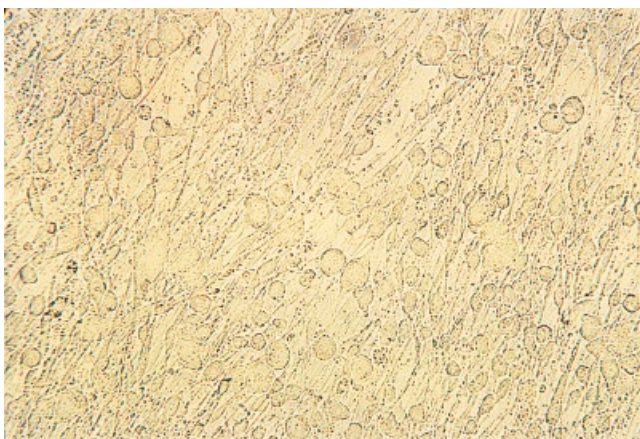
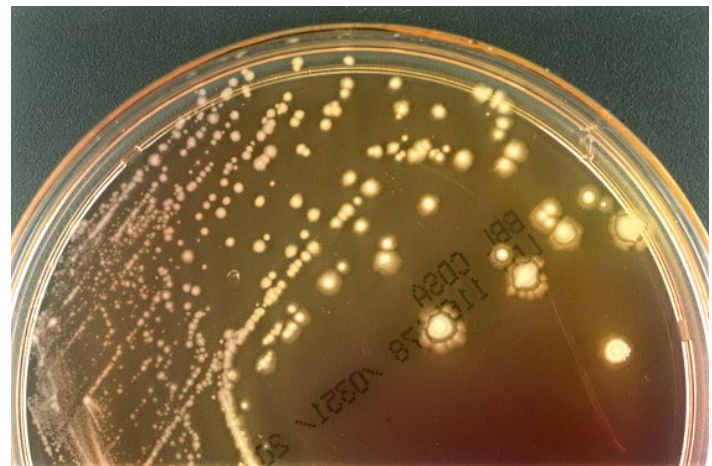


Figure 28-10 *Clostridioides difficile* on BBL *Clostridioides difficile* selective agar. BBL *C. difficile* selective agar (BD Diagnostic Systems, Franklin Lakes, NJ) is a selective and differential medium developed for the isolation of *C. difficile*. Large colonies with a yellow color characteristic of *C. difficile* are shown. As growth of *C. difficile* occurs, the pH of the medium increases, causing the neutral red indicator to turn yellow. Due to intestinal colonization, laboratory confirmation of the diagnosis of *C. difficile*-induced diarrhea depends on verifying toxin production. Colonies from this agar are subcultured to a broth, and the filtered liquid can be used to perform the cytotoxin assay.



A



B

Figure 28-11 Cytotoxin neutralization assay for *Clostridioides difficile* with MRC-5 cells. Cytotoxin neutralization can be used to detect the presence of *C. difficile* toxin B, since this organism is frequently isolated from asymptomatic individuals and toxigenic isolates are the only pathogenic strains. To perform this test, before being placed on a tissue culture monolayer, an aliquot from the fecal supernatant is incubated with antiserum that neutralizes toxin B. A second fecal aliquot is placed directly onto the cell monolayer. A positive specimen produces a cytopathic effect on the directly inoculated monolayer (A), while no cytopathic effect is detected on the control monolayer, in which neutralizing antiserum to toxin B was added (B).

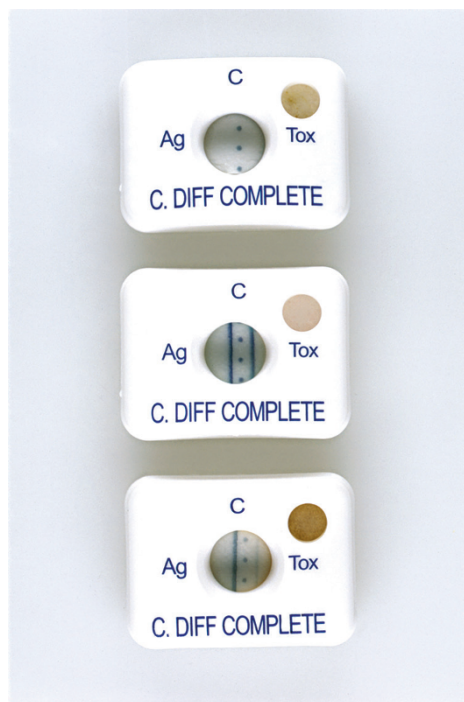


Figure 28-12 Detection of *Clostridioides difficile* GDH and toxins A and B by EIA. The *C. Diff* Quik Chek Complete assay (TechLab, Inc., Blacksburg, VA) simultaneously detects the presence of GDH, an antigen unique to *C. difficile*, and toxins A and B by using specific antibodies for these three components. The GDH test is highly sensitive but lacks specificity because there are strains of *C. difficile* that are not toxigenic. The assay for toxins A and B is highly specific but not very sensitive. The blue dots in the middle of the reaction window represent the internal controls. These dots need to be positive in order for the results to be interpreted. A blue line on the “Ag” and “Tox” sides indicates that the antigen and the toxins (A and/or B), respectively, are positive. In this figure, the top reaction is negative for both the antigen and the toxins, the middle card is positive for both, and the bottom is positive for the antigen and negative for the toxins.

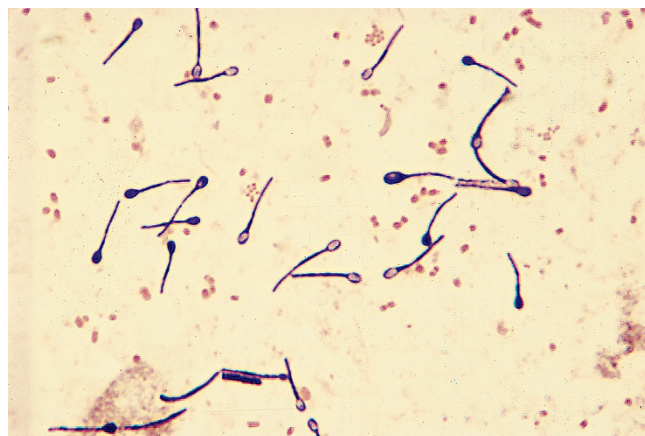


Figure 28-13 Gram stain of *Clostridium paraputrificum* from a blood culture. The organisms appear here as long, thin, straight or slightly curved, Gram-positive bacilli, 0.5 to 1.5 μm by 2.0 to 20 μm , with oval, terminal spores that swell the cells. In the background, small, Gram-negative bacilli with bipolar staining can be observed.

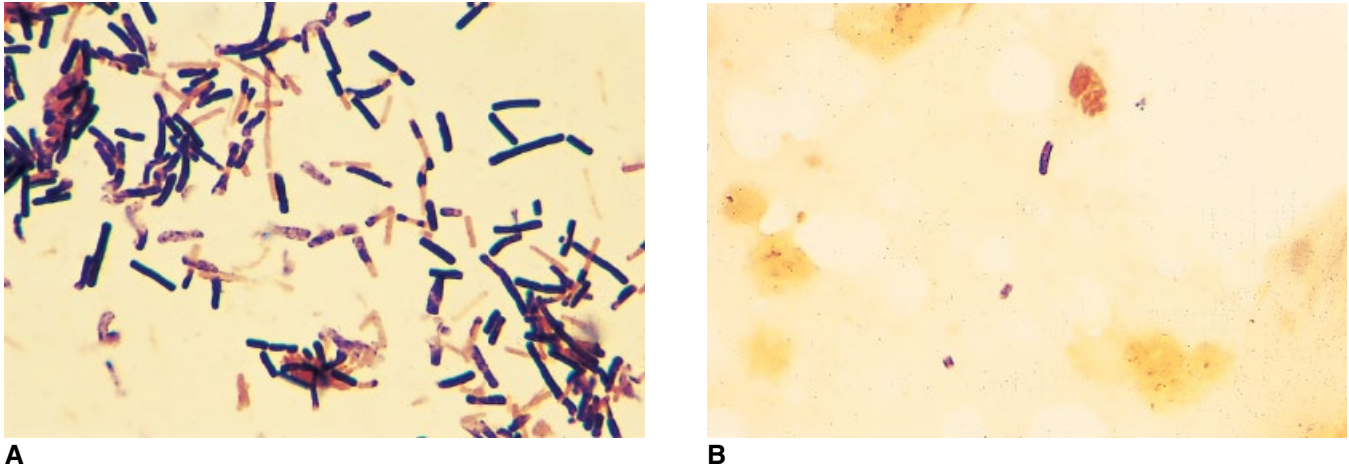


Figure 28-14 Gram stain of *Clostridium perfringens* from a culture and from a patient with necrotizing fasciitis. (A) *C. perfringens* organisms in culture are Gram-positive bacilli with blunt ends, described as boxcar shaped, usually 2 to 4 μm long by 0.8 to 1.5 μm in diameter. Some of the cells in this preparation are Gram negative, and no spores are present. Spores are rarely seen *in vivo* or *in vitro*; when found, they are large, oval, and central or subterminal in location and cause the cell to swell. Young cultures often have short, coccoid cells, while older cultures contain longer, filamentous cells. (B) Direct Gram stains from tissue from patients with gas gangrene are characterized by the absence of inflammatory cells and the presence of boxcar-shaped, Gram-variable bacilli.

Figure 28-15 *Clostridium perfringens* on brucella agar (left) and phenylethyl alcohol agar (right). A double zone of hemolysis can be seen surrounding the colonies. The smaller zone of complete hemolysis is produced by a theta-toxin, a heat- and oxygen-labile toxin, while the outer zone of partial hemolysis is produced by phospholipase C, an alpha-toxin that is also responsible for the lecithin hydrolysis shown in Fig. 28-16.





Figure 28-16 *Clostridium perfringens* on egg yolk agar. On egg yolk agar, *C. perfringens* is lecithinase positive, as seen by the zone of opacity surrounding the colony. This effect is produced by phospholipase C, also called alpha-toxin, which hydrolyzes the lecithin. This opacity is not a surface phenomenon but, rather, is in the medium itself due to the precipitation of complex fats.



Figure 28-17 Reverse CAMP test for identification of *Clostridium perfringens*. More than 95% of *C. perfringens* strains produce a positive reverse CAMP test. To perform this test, a CDC anaerobe blood agar plate is inoculated down the center with a single streak of *Streptococcus agalactiae* (group B streptococcus), which produces a diffusible extracellular protein (CAMP factor) that can act synergistically with the *C. perfringens* alpha-toxin to lyse erythrocytes. The suspected isolate of *C. perfringens* is inoculated perpendicularly to, but not touching, the *Streptococcus* streak, and the plate is incubated anaerobically for 24 to 48 h. As shown here, development of an arrowhead of hemolysis with the tip coming from the *Streptococcus* strain toward the *Clostridium* strain indicates a positive test.

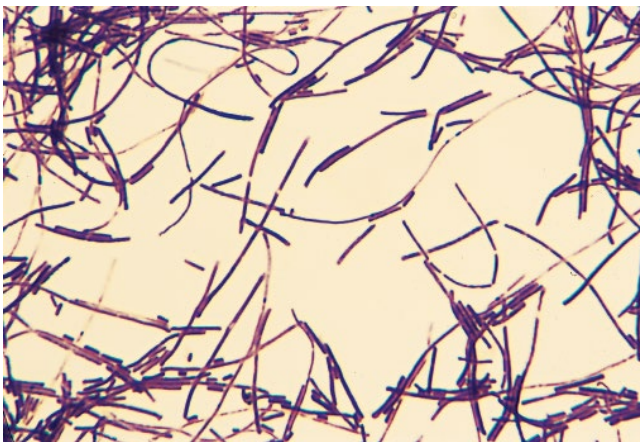


Figure 28-18 Gram stain of *Clostridium ramosum*. *C. ramosum* organisms are Gram-variable, straight or curved bacilli that frequently produce short chains, V-shaped arrangements, and long filaments. They are thinner than most clostridia, varying from 0.5 to 0.9 μm in diameter and 2.0 to 13 μm in length. Spores are rarely produced; when present, they are small, round, and usually terminal, causing swelling of the cell. *C. ramosum* is one of the clostridia most frequently isolated from clinical specimens from children and adults, particularly following abdominal trauma.



Figure 28-19 *Clostridium ramosum* on CDC agar. Colonies of *C. ramosum* are small, gray-white or translucent, smooth, irregular with scalloped margins, and nonhemolytic.

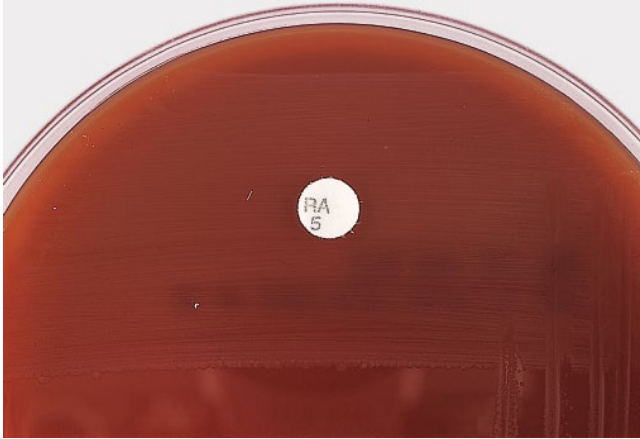


Figure 28-20 Antimicrobial susceptibility testing of *Clostridium ramosum*. As shown here, *C. ramosum* is one of the few anaerobic organisms resistant to rifampin (RA).

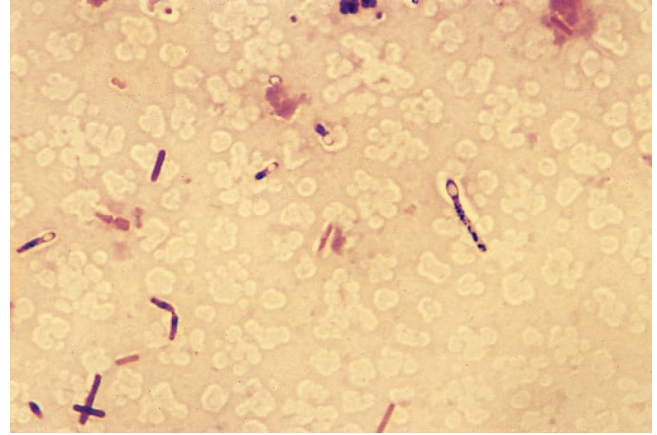


Figure 28-21 Gram stain of *Clostridium septicum* from a blood culture. In young cultures, this organism appears Gram positive; however, it becomes Gram negative with age and often stains unevenly. The bacilli are straight or curved and may occur singly or in pairs. The spores swell the cell, are oval, and have a subterminal location, as shown here.

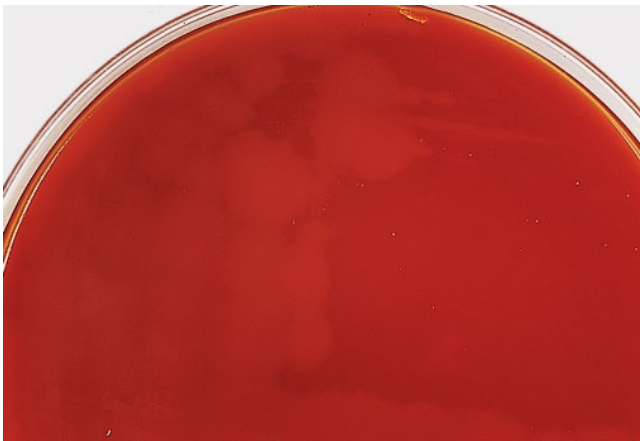


Figure 28-22 *Clostridium septicum* on CDC agar. *C. septicum* produces a typical colony that is gray, glossy, translucent, and beta-hemolytic, with a rhizoid margin resembling a Medusa head. As shown here, colonies can swarm in less than 24 h, forming an invisible film over the agar surface.

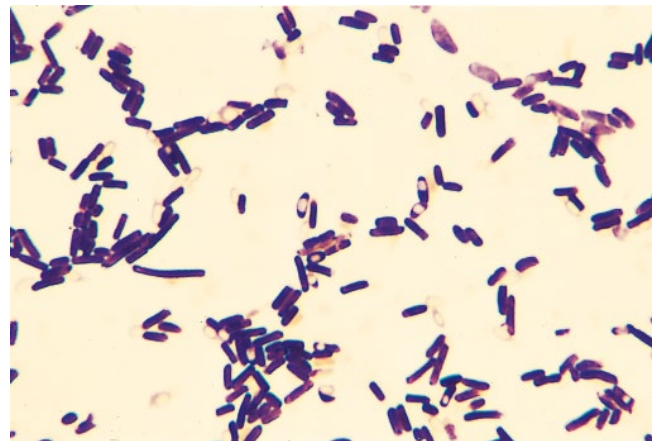
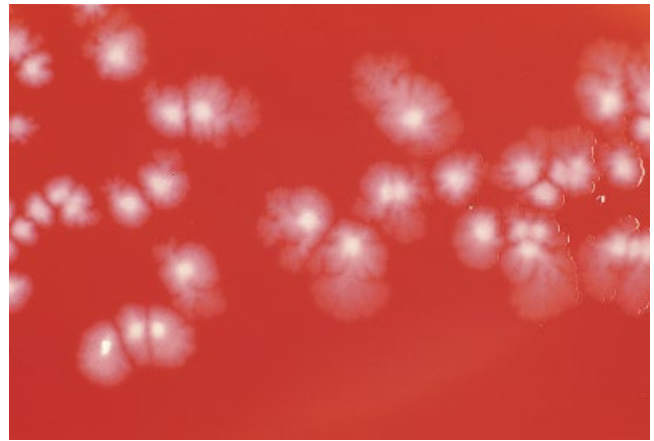


Figure 28-23 Gram stain of *Clostridium sordellii*. On prolonged incubation under anaerobic conditions, *C. sordellii* can produce oval, central to subterminal spores that cause a slight swelling of the cells. Free spores are also observed in some preparations.

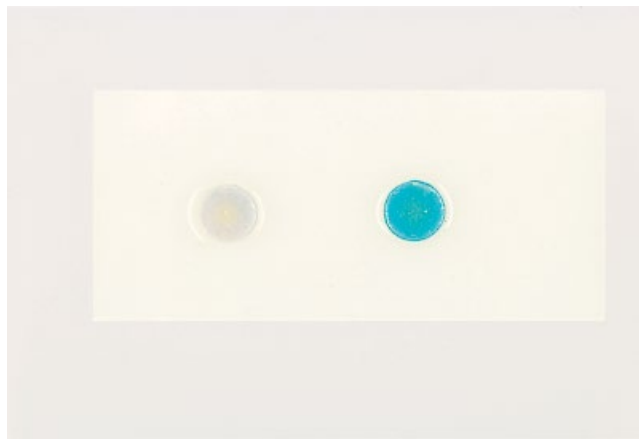


A

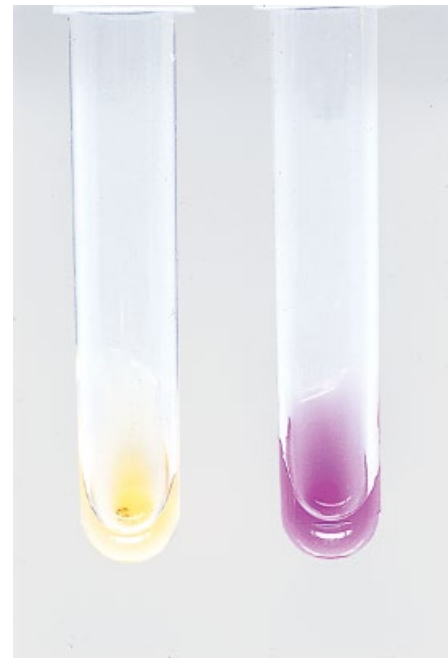


B

Figure 28-24 *Clostridium sordellii* on CDC agar. On CDC agar, colonies of *C. sordellii* appear white or gray and chalk-like, opaque to translucent, with lobate edges. (A) Low magnification; (B) high magnification.



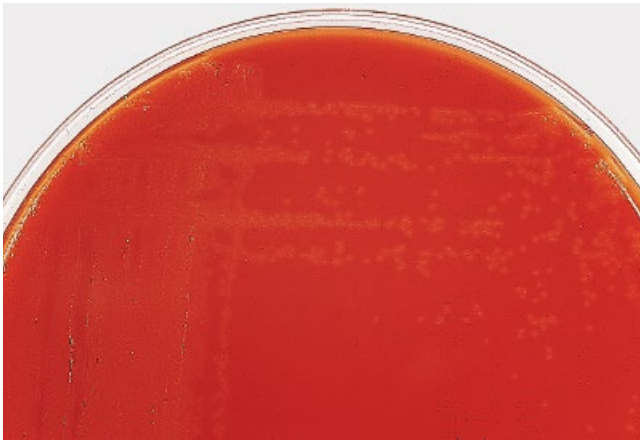
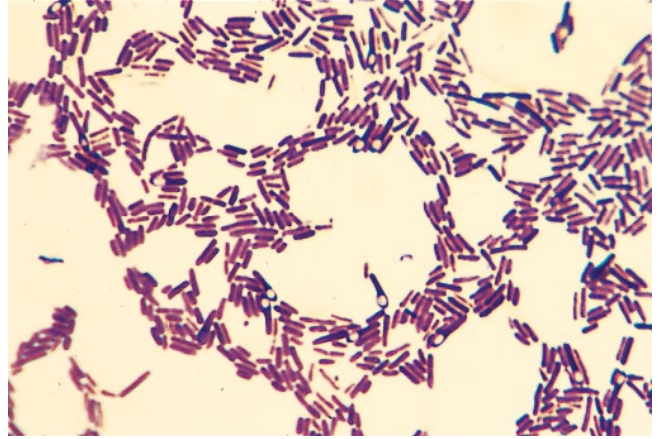
A



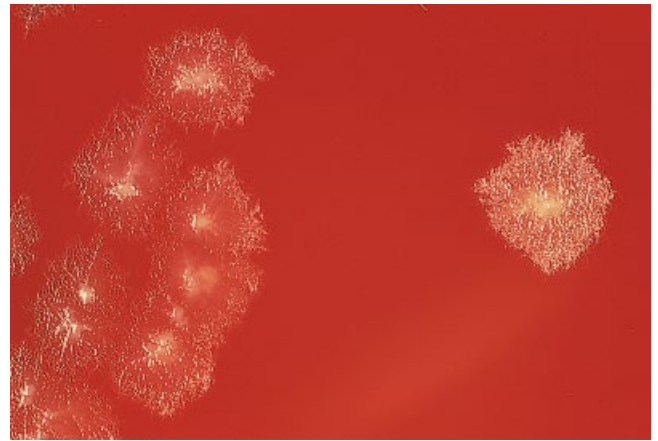
B

Figure 28-25 Urea and indole reactions of *Clostridium sordellii*. *C. sordellii* is one of the few clostridia that give positive indole (A) and urea (B) reactions. In both images, the negative reaction is on the left and the positive reaction is on the right.

Figure 28-26 Gram stain of *Clostridium sporogenes*. *C. sporogenes* is one of the smaller species in the genus, with cells varying from 0.3 to 1.4 μm by 1.3 to 16 μm . They occur singly and readily produce oval, subterminal spores that swell the cell.



A



B

Figure 28-27 *Clostridium sporogenes* on CDC agar. Colonies of *C. sporogenes* are moist, white, and opaque at the center, with rhizoid edges that, within 4 to 6 h, form Medusa heads that attach firmly to the agar. By 24 to 48 h of incubation, the colony may swarm, becoming a heavy film of growth that covers the plate. (A) Low magnification; (B) high magnification.

Figure 28-28 Gram stain of *Clostridium tertium* from a blood culture. The bacilli are long, thin, and Gram variable and have large, oval, terminal spores that cause marked swelling of the cells.

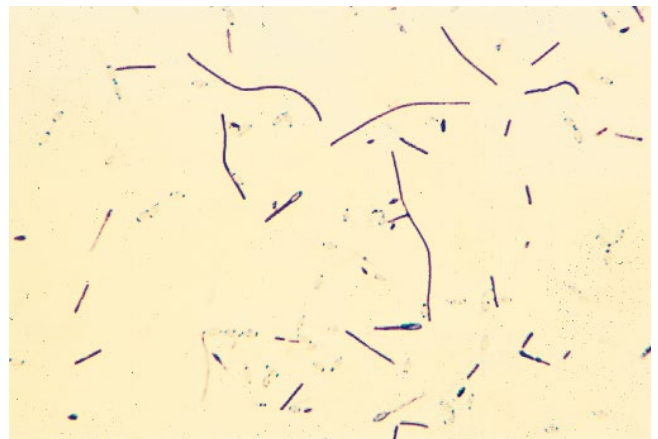


Figure 28-29 *Clostridium tertium* on CDC agar under anaerobic (left) and aerobic (right) conditions. As shown here, *C. tertium* is one of the few aerotolerant species of *Clostridium* found in clinical specimens. *C. tertium* can easily be confused with non-spore-forming, Gram-negative bacilli or with *Bacillus* spp. This species can be differentiated from *Bacillus* spp. based on sporulation requirements, with *C. tertium* sporulating only under anaerobic conditions and *Bacillus* producing spores only under aerobic conditions.

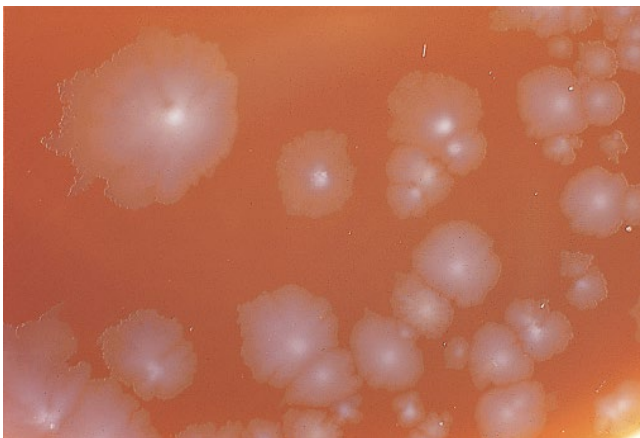
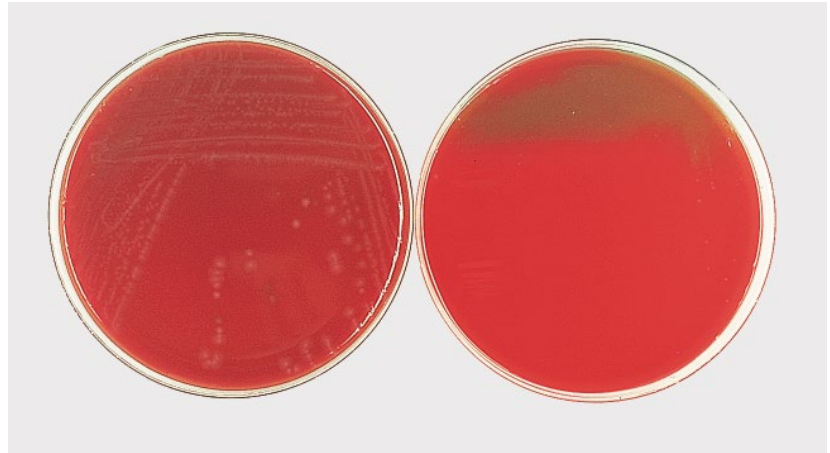


Figure 28-30 *Clostridium tertium* on CDC agar. Colonies of *C. tertium* measure 2 to 4 mm in diameter and are white to gray, opaque to translucent, and circular with irregular edges. Hemolysis is variable, and there are alpha-hemolytic, beta-hemolytic, and nonhemolytic strains.

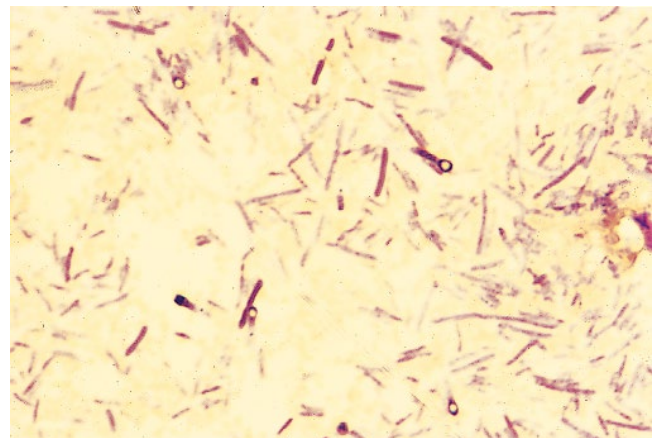


Figure 28-31 Gram stain of *Clostridium tetani*. This preparation shows Gram-variable bacilli singly and in pairs, with round spores that are located in the terminal region, giving a tennis racket- or drumstick-like appearance. Initially the cells appear Gram positive, but after 24 h of incubation, they readily stain Gram negative.

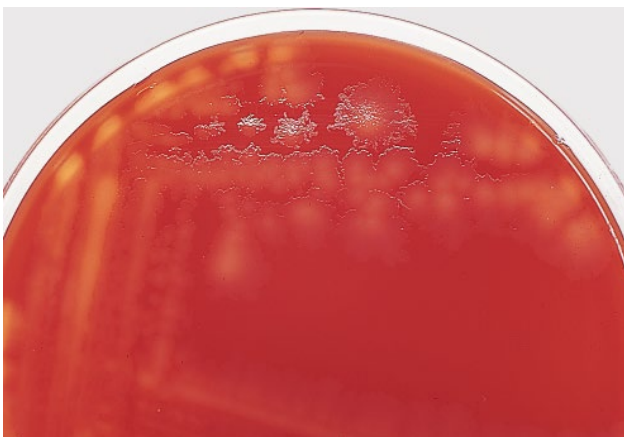


Figure 28-32 Culture of *Clostridium tetani* on CDC agar. Colonies of *C. tetani* are 4 to 6 μm in diameter, gray, translucent, and flat with an irregular to rhizoid margin and may swarm on the agar surface. A small zone of beta-hemolysis can be observed around the colonies. *C. tetani* is generally found mixed with other organisms in wounds and is often very fastidious and difficult to grow.

Peptostreptococcus, *Finegoldia*, *Anaerococcus*, *Peptoniphilus*, *Cutibacterium*, *Lactobacillus*, *Actinomyces*, and Other Non-Spore-Forming, Anaerobic Gram-Positive Bacteria

29

ANAEROBIC GRAM-POSITIVE COCCI

The obligate anaerobic, Gram-positive cocci include cocci that do not produce spores and sometimes appear as elongated coccobacilli. A major change in taxonomy resulted in the reclassification of many anaerobic cocci and the proposal of several new genera. The anaerobic Gram-positive cocci discussed in this chapter are those isolated from clinical specimens and are known to cause infections in humans. They include *Anaerococcus*, *Finegoldia*, *Parvimonas*, *Peptococcus*, *Peptoniphilus*, and *Peptostreptococcus*. The only species remaining in the genus *Peptococcus* is *Peptococcus niger*, and the only two *Peptostreptococcus* species are *Peptostreptococcus anaerobius* and *Peptostreptococcus stomatis*. *Peptostreptococcus saccharolyticus* has been reclassified as *Staphylococcus saccharolyticus*. The two species most commonly found in clinical specimens are *Finegoldia magna* and *Peptoniphilus asaccharolyticus*, although isolates identified as *P. asaccharolyticus* in the past may have been *Peptoniphilus harei*. *Peptococcus niger* is rarely isolated from clinical specimens.

The anaerobic Gram-positive cocci are members of the normal microbiota of the skin, oropharynx, and upper respiratory tract, as well as the gastrointestinal and genitourinary tracts. For the most part they are considered opportunistic pathogens. They have been isolated from a wide variety of specimens, although primarily from abscesses and infections of the skin and soft tissue, bones, female genital tract, joints, lung, mouth, and

upper respiratory tract. They have been associated with head and neck infections, oral and dental infections, chronic otitis media and sinusitis, periodontitis, necrotizing and aspiration pneumonia, empyema, and brain abscesses. Anaerobic Gram-positive cocci have also been recognized for many years as causes of genital infections, including postpartum endometritis, tubo-ovarian abscesses, pelvic inflammatory disease, septic abortions, and chorioamnionitis. Bacteremia is a complication that is not uncommon following gynecological or obstetric infections. However, bacteremia with anaerobic Gram-positive cocci is less severe than bacteremia caused by *Bacteroides*, which is often fatal. In patients with a perforated bowel, appendicitis, penetrating trauma including surgery, or cancer, mixed infections with other anaerobes, *Enterobacterales*, and *Enterococcus* spp. are common and can lead to an intra-abdominal abscess. Many anaerobic Gram-positive cocci are isolated from polymicrobial infections. The presence of multiple organisms may be overlooked as clinically insignificant.

The anaerobic Gram-positive cocci that have been isolated in pure culture include *F. magna*, *Peptostreptococcus anaerobius*, *Parvimonas micra*, *Peptoniphilus asaccharolyticus*, *Peptoniphilus indolicus*, *Peptoniphilus harei*, *Anaerococcus prevotii*, and *Anaerococcus vaginalis*. *F. magna* is the most pathogenic and one of the most frequently isolated anaerobic, Gram-positive cocci isolated from clinical specimens. It also has been associated with toxic shock syndrome and has the ability to form biofilms. *P. anaerobius* is one of the most common anaerobic Gram-positive cocci associated with abdominal

cavity and female genitourinary tract infections. *P. micra* is an oral pathogen, although it can cause infections in other body sites. *Peptoniphilus* spp. have been associated with pressure and diabetic ulcers and rhinosinusitis.

Gram stains of clinical material can be useful for detecting the presence of mixed infections and can also provide presumptive evidence of certain anaerobes; however, this method is of little value in differentiating anaerobic from aerobic and facultative, Gram-positive cocci. The anaerobic Gram-positive cocci can vary in size from 0.3 to 1.6 μm , and changes in staining characteristics and morphology may occur as a result of growth on different media and with the age of the organism. This makes the interpretation of the Gram stain difficult. When Gram-negative or Gram-variable staining is observed, determining susceptibilities to vancomycin (5- μg disk), kanamycin (1,000- μg disk), and colistin (10- μg disk) can be helpful in differentiating Gram-positive from Gram-negative anaerobic organisms. Older cells may appear coccobacillary or rod-like. It is important to distinguish the Gram-positive anaerobic cocci from microaerophilic organisms, such as microaerophilic streptococci.

Anaerobic media, including brucella agar, Columbia agar, and Schaedler agar base supplemented with vitamin K₁ and hemin, are recommended since they support the growth of these organisms. In clinical specimens, it can also be difficult to identify microaerophilic streptococci, which may grow only on primary anaerobic media but will subsequently grow in 5 to 10% CO₂ upon repeat subculture. A metronidazole (5- μg) disk test can be used as an inexpensive but effective technique to differentiate microaerophilic organisms from anaerobic Gram-positive cocci. Microaerophilic strains show no inhibition of growth, while anaerobic Gram-positive cocci demonstrate a zone of inhibition of at least 15 mm around a metronidazole disk.

F. magna cells are 0.7 to 1.2 μm in diameter and appear in pairs, clusters, or a tightly packed arrangement, larger than those of most peptostreptococci, and may resemble staphylococci. Colonies are minute to 0.5 mm in diameter, circular, dull, smooth, and nonhemolytic. *P. micra*

colonies are minute to 1 mm in diameter, convex, and dull and are surrounded by a milky halo. The cells are similar in appearance to those of *F. magna* but are smaller (0.3 to 0.7 μm in diameter) and usually form short chains. Since different growth conditions result in strain variability, differentiation of the two species is subjective when based on their cellular morphology alone.

Colonies of *P. anaerobius* are usually larger and vary in diameter from 0.5 to 2 mm. They are gray-white and non-hemolytic and may have a pungently sweet odor. The cells are 0.5 to 0.6 μm in diameter, and in young cultures they may appear as oval/elongated cocci in chains. A presumptive identification can be made based on sodium polyanethol sulfonate (SPS) susceptibility. *P. anaerobius* has a zone of ≥ 12 mm around a 5% SPS disk, which is considered susceptible. *Peptoniphilus ivorii* may also have a ≥ 12 -mm zone around a 5% SPS disk, although its microscopic morphology differs from that of *P. anaerobius* in that it forms large cocci in clumps, and the cells of *P. anaerobius* appear as oval cocci in chains. Also, the colonial morphology of the two organisms differs in that colonies of *P. ivorii* are slightly yellow and convex and lack the sweet odor. *P. micra* also exhibits a zone of inhibition with SPS; however, the zone is < 12 mm, which is considered resistant.

P. asaccharolyticus produces colonies that may appear small white to yellow, are translucent, and have a musty odor. They can vary from minute to 2 mm in diameter, and on Gram staining, they may be arranged in pairs, tetrads, or clumps. Older cells may appear Gram negative. A presumptive identification can be reported if the anaerobic Gram-positive cocci are isolated from a human clinical specimen and are SPS resistant and indole positive. *P. indolicus*, which is also indole positive, is rarely isolated from clinical specimens.

Rapid key tests—indole, urease, and the inhibition of growth in the presence of SPS—aid in the presumptive identification of some anaerobic Gram-positive cocci (Table 29-1). The ability of rapid commercial systems to accurately identify the members of this group ranges from 15% for *A. prevotii* to 90 to 100% for *P. micra*, *F. magna*, *P. asaccharolyticus*, and *P. anaerobius*.

Table 29-1 Characteristics of the most commonly isolated anaerobic Gram-positive cocci^a

Species	SPS	Indole	Urease	Cells of $\geq 0.6 \mu\text{m}$	Gram stain morphology
<i>Fingoldia magna</i>	R	0	0	+	Cocci are large; arranged in pairs, tetrads, and clusters
<i>Parvimonas micra</i>	R	0	0	0	Cocci are small; arranged in pairs, chains, and clusters
<i>Peptoniphilus</i>	R	+	0	0	Cells stain poorly; cocci are uniform in size and clump
<i>asaccharolyticus</i>					
<i>Peptostreptococcus anaerobius</i>	S	0	0	0	Cocci are pleomorphic; arranged in chains

^a+, positive reaction; 0, negative reaction; S, susceptible; R, resistant.

Although biochemical tests may be helpful, identification based on the results of these tests alone should be considered presumptive. Identification by 16S rRNA gene sequencing and matrix-assisted laser desorption ionization-time of flight mass spectrometry (MALDI-TOF MS) has greatly improved the identification of anaerobes. When MALDI-TOF MS is used for identification, the isolate should be tested after 48 h of incubation and <24 hours of exposure to oxygen. For Gram-positive anaerobic bacteria, 70% formic acid is used for extraction.

ANAEROBIC, NON-SPORE-FORMING, GRAM-POSITIVE BACILLI

The anaerobic, non-spore-forming, Gram-positive bacilli make up a diverse group varying from obligately to facultatively anaerobic organisms, and in recent years there have been significant taxonomic changes. For example, *Propionibacterium acnes*, along with other *Propionibacterium* species, has been reclassified into a new genus, *Cutibacterium*. *Propionibacterium propionicum*, a cause of actinomycosis, has been reclassified as *Pseudopropionibacterium propionicum*. Two other *Propionibacterium* species, *Propionibacterium lymphophilum* and *Propionibacterium innocua*, isolated from clinical specimens, have been reclassified as *Propionimicrobium lymphophilum* and *Propioniferax innocua*.

The anaerobic non-spore-forming Gram-positive bacilli that may cause infections in humans are divided into two phyla, *Actinobacteria* and *Firmicutes*. The genera in the phylum *Actinobacteria* include *Actinobaculum*, *Actinomyces*, *Actinotignum*, *Adlercreutzia*, *Alloscardovia*, *Atopobium*, *Bifidobacterium*, *Collinsella*, *Cryptobacterium*, *Cutibacterium*, *Eggerthella*, *Enterorhabdus*, *Gordonibacter*, *Mobiluncus*, *Olsenella*, *Paraeggerthella*, *Parascardovia*, *Propioniferax*, *Propionimicrobium*, *Pseudopropionibacterium*, *Scardovia*, *Slackia*, and *Varibaculum*. The genera in the phylum *Firmicutes* include *Anaerofustis*, *Anaerostipes*, *Anaerotruncus*, *Blautia*, *Bulleidia*, *Catabacter*, *Catenibacterium*, *Catonella*, *Coprobacillus*, *Dorea*, *Eggerthia*, *Eisenbergiella*, *Eubacterium*, *Faecalibacterium*, *Filifactor*, *Flavonifractor*, *Holdemania*, *Lachnoanaerobaculum*, *Lachnospira*, *Lactobacillus*, *Marvinbryantia*, *Mogibacterium*, *Moryella*, *Oribacterium*, *Pseudoramibacter*, *Robinsoniella*, *Roseburia*, *Shuttleworthia*, *Solobacterium*, *Stomatobaculum*, *Subdoligranulum*, and *Turicibacter*.

Humans and animals are the natural habitat of these organisms. *Actinomyces* and *Atopobium* spp. are found in the mouth and upper respiratory tract. *Bifidobacterium* and *Eubacterium* spp. are usually present in the mouth and are found in large numbers in the intestinal tract. *Lactobacillus* spp. are widely distributed throughout the body, including the mouth and the intestinal and genital tracts. *Mobiluncus* spp. normally inhabit the genital tract, and *Cutibacterium* spp. can be isolated from the skin, conjunctiva, oral cavity, and large intestine. *Adlercreutzia*, *Anaerofustis*, *Anaerostipes*, *Anaerotruncus*, *Blautia*, *Catenibacterium*, *Catonella*, *Collinsella*, *Coprobacillus*, *Dorea*, *Enterorhabdus*, *Faecalibacterium*, *Gordonibacter*, *Holdemania*, *Lachnoanaerobaculum*, *Lachnospira*, *Marvinbryantia*, *Moryella*, *Propioniferax*, *Roseburia*, *Stomatobaculum*, *Subdoligranulum*, and *Turicibacter* have been recovered from feces and the oral cavity. In addition, *Anaerostipes*, *Anaerotruncus*, and *Turicibacter* have caused bacteremia, although rarely.

The anaerobic, non-spore-forming, Gram-positive bacilli are opportunistic pathogens that seldom cause infections alone but are most often found in polymicrobial infections throughout the body, provided that suitable conditions for colonization and penetration exist. Actinomycosis is a chronic granulomatous infection that can result in abscess formation with draining sinuses. The purulent discharge frequently contains sulfur granules, which are masses of bacteria cemented together by a polysaccharide-protein complex and calcium phosphate, with colors ranging from white to yellow-brown. The presence of sulfur granules is considered diagnostic. If the granules are large enough, they can be crushed and observed microscopically (100× objective) by the wet-mount technique. Sulfur granules have characteristic club-shaped masses of filaments radiating from the granules. They are Gram-positive branched and unbranched filaments. When sulfur granules are present, they should be rinsed with sterile broth, crushed, and used to inoculate anaerobic media. The Brown-Brenn stain facilitates the detection of sulfur granules in histological preparations. Staining of tissue specimens with hematoxylin and eosin shows that the periphery of the granules has eosinophilic clubs. Besides *Actinomyces*, other organisms, such as *Nocardia*, *Streptomyces*, and *Staphylococcus*, can also produce granules with clubs. Actinomycosis can occur in the brain, the lower respiratory tract, and the genital tract, especially in infections related to intrauterine devices; however, the most common infections occur in cervicofacial regions in males.

Although *Actinomyces israelii* is the species most frequently isolated from human actinomycosis, other species of *Actinomyces*, as well as *Pseudopropionibacterium propionicum*, may also be etiological agents.

Actinomyces spp. have been isolated from a variety of sites, including cutaneous, central nervous system, dental and oral, musculoskeletal, and pericardial sites and including a variety of other invasive specimens. *Actinomyces odontolyticus* is responsible for a majority of *Actinomyces* blood infections. *A. israelii* and *Actinomyces meyeri* have been associated with central nervous system infections. *Actinomyces* spp. have also been related to granulomatous breast infections. However, the isolation of *Actinomyces* spp. does not confirm that the patient is infected, and therefore, clinical correlation may be needed to confirm infection.

Actinotignum schaalii (previously *Actinobaculum schaalii*) is the most frequently implicated in disease among species of the genera *Actinobaculum* and *Actinotignum*. Infections include abscesses, bacteremia, cellulitis, and gangrene, although the majority are urinary tract infections in the elderly. On Gram staining, *Actinobaculum* and *Actinotignum* appear as straight or slightly curved Gram-positive bacilli, with occasional branching. Colonies are small (~1 mm in diameter), gray or white and nonhemolytic, although *Actinotignum urinale* may be weakly beta-hemolytic. Cultures must be incubated for 48 hours in CO₂ or anaerobically to be able to recover the organisms.

Cutibacterium, a recently described genus, was formerly classified as the cutaneous group of *Propionibacterium*. The most important species is *C. acnes*, previously classified as *Propionibacterium acnes*. *Cutibacterium acnes* is part of the skin microbiota and plays a significant role in acne vulgaris. *Cutibacterium* spp. can cause infections of the skin, conjunctiva, bone, joints, and central nervous system. Infections are often associated with surgical procedures or foreign bodies, such as prosthetic valve and ventriculoarterial shunt implants. However, it has been isolated from a variety of clinical specimens, including sputum, and from the gastrointestinal and genitourinary tracts. Of concern is the ability of the organism to form biofilms on implanted foreign bodies. *C. acnes* was considered a contaminant until it was reported as a causative agent of prosthetic joint, especially shoulder, infections. Other species, including *Cutibacterium avidum*, *Cutibacterium granulorum*, and "*Cutibacterium humerusii*," are also associated with infections related to prosthetic devices, including abscesses, endocarditis, endophthalmitis, and

osteomyelitis, although infections with these species are less common than those with *C. acnes*.

Other members of this group of anaerobes are generally nonpathogenic. Although *Eubacterium* and *Bifidobacterium* spp. are rarely encountered in clinical specimens, *Eubacterium* spp. have been isolated in mixed cultures from wounds and abscesses, as well as oral infections, and *Bifidobacterium dentium*, one of the few species in this genus with pathogenic potential, has been isolated from dental caries and from other clinical material. *Lactobacillus* spp. are rarely involved in human infection but have been isolated from cases of bacteremia, endocarditis, and intra-abdominal abscesses, particularly in immunocompromised patients. The pathogenicity of *Mobiluncus* spp. is not well defined; however, it is generally thought to play a role in bacterial vaginosis.

Actinomyces spp. can vary from straight or slightly curved bacilli (0.2 to 1.0 µm) to slender filaments with true branching. The cells may have swollen, clubbed, or clavate ends and may occur singly or in pairs with a diphtheroidal arrangement or may be pleomorphic. They are Gram positive, but their irregular staining can result in a beaded or banded appearance. A modified acid-fast stain can be used to differentiate *Actinomyces* spp. from *Nocardia* spp., which are partially acid fast, while *Actinomyces* spp. are negative. *A. israelii* is noted for its branching filaments on Gram staining and also for its colony morphology. All *Actinomyces* spp. are microaerophilic, except *A. meyeri*, which is an obligate anaerobe. They are slow growers, requiring at least 48 h for colonies to appear on primary culture. Young colonies commonly have branching filaments radiating from a central point, giving the appearance of "spider colonies." As the colonies mature, they become rough and umbonate with undulate edges, resulting in a "molar tooth" appearance. Other *Actinomyces* spp. can produce colonies ranging from smooth and circular to granular or "raspberry-like." Most colonies are gray-white and opaque. Catalase, urease, and pigment production are helpful in species determination. With the exception of *Actinomyces viscosus*, most *Actinomyces* spp. are catalase negative. *Actinomyces odontolyticus* produces a red pigment, and *Actinomyces naeslundii* and *A. viscosus* are urea positive. The biochemical reactions of several newer species are based on a single strain. As a result, discrepancies in some biochemical tables differentiating the *Actinomyces* spp. may appear.

Bifidobacterium spp. can be diphtheroid to filamentous with pointed, club-shaped, or slightly bifurcated ends and may appear to be branching; however, they are generally larger than the cells of *Actinomyces* spp. and *Cutibacterium* spp. They can occur singly, in chains, or in a palisade arrangement. Gram stains from solid media vary from coccoid to long or curved bacilli with swollen ends. *Bifidobacterium dentium* may appear as bifid forms. Colonies are entire, convex, and white to cream. *Bifidobacterium* spp. are catalase, indole, and nitrate negative but positive for esculin hydrolysis. Most species of *Bifidobacterium* and *Lactobacillus* grow well on media with an acid pH, although lactobacilli grow well on routine blood agar or blood culture media.

Cutibacterium spp. may appear pleomorphic, diphtheroidal, or club shaped with round or tapered ends and can be coccoidal or branching. Cells can measure 0.5 to 0.8 μm by 1.5 μm . The morphology of *C. acnes* may vary considerably. *C. acnes* is a slow-growing aerotolerant, catalase-positive organism. On culture it appears as a small, white, shiny to opaque, convex colony with an entire edge. *C. acnes* is the only indole- and nitrate-positive species. *C. avidum* is esculin hydrolysis positive, whereas *C. acnes* and *C. granulosum* are esculin hydrolysis negative. A presumptive identification of *C. acnes* can be made if an anaerobic Gram-positive bacillus has a pleomorphic, diphtheroid morphology and is indole positive and catalase positive.

Eubacterium spp. vary from uniform to pleomorphic bacilli. They may be coccoid, diphtheroidal, or filamentous and can be thin to plump. They are generally arranged in pairs, short chains, or sometimes small clumps. The colonies are small, ranging from punctiform to 2 mm; entire; circular; and translucent to slightly opaque. They are biochemically inactive. As a result, they cannot be reliably identified by phenotypic methods.

Eggerthella lenta (formerly *Eubacterium lentum*) appears as small, pleomorphic Gram-positive bacilli, without branching. The colonies are small, circular, entire, and translucent. Colonies may appear speckled and fluoresce red.

Lactobacillus spp. are Gram-positive bacilli that vary from long and slender with straight sides to slightly bent or coryneform coccobacilli. The length of the cell and the degree of curvature are based on the age of the culture, the medium, and the oxygen tension. Most *Lactobacillus* spp. isolated from clinical specimens are microaerophilic, but some are obligate anaerobes. After 72 h, anaerobic *Lactobacillus* spp. produce colonies,

measuring 2 to 5 mm in diameter, that are convex, entire, smooth, opaque, and nonpigmented. They can usually be identified by their Gram stain morphology, negative catalase reaction, and production of lactic acid from the metabolism of glucose.

Mobiluncus spp. are strict anaerobes. They are curved bacilli, with tapered ends and consistently stain Gram negative or Gram variable; however, their cell wall lacks lipopolysaccharide and is structurally similar to that of Gram-positive organisms. The spinning motility of *Mobiluncus* spp. distinguishes them from other anaerobic, non-spore-forming, Gram-positive bacilli. Two species are now recognized. *Mobiluncus curtisii* is a curved, Gram-variable bacillus with pointed ends and measures 1.7 μm in length, while *Mobiluncus mulieris* is Gram negative and longer, measuring 2.9 μm . Both are oxidase, catalase, and indole negative.

Aerotolerance, Gram stain, colony morphology, fluorescence under long-wave UV light, pigment production, and biochemical reactions such as nitrate, catalase, indole, and esculin can be useful in the presumptive identification of the more commonly isolated or clinically important anaerobes in this group (Table 29-2). For instance, a catalase-positive organism is probably *Cutibacterium* or *A. viscosus*. An indole-positive organism is likely to be *Cutibacterium*, and with a positive nitrate test, one can generally rule out *Bifidobacterium* and *Lactobacillus* spp. Most *Actinomyces* and *Cutibacterium* spp. are facultatively anaerobic or microaerophilic, while only a few *Eubacterium* strains tolerate oxygen. Although colony morphology, cell morphology, and rapid biochemical tests may be useful for presumptively grouping the non-spore-forming, anaerobic Gram-positive bacilli into genera, these characteristics may be variable, and analysis of metabolic end products and molecular methods may be necessary for definitive species identification.

Historically, identification of anaerobic, non-spore-forming Gram-positive bacilli to the species level was based on sugar fermentation and enzymatic reactions, although this approach lacked accuracy. Differentiating *Actinomyces* and *Lactobacillus* using phenotypic tests was proven to be inaccurate when the isolates were tested using 16S rRNA sequencing. Gas-liquid chromatography is a tedious method for use in the clinical laboratory and therefore is not widely used. However, the introduction of commercial identification systems for anaerobes has been an improvement over previous methods, and a variety of systems are being used in clinical laboratories. Some commonly used systems include

Table 29-2 Characteristics of the anaerobic, non-spore-forming, Gram-positive bacilli^a

Species	Aerotolerance	Catalase	Indole	Nitrate	Esculin	Motility	Urea	Pigment
<i>Actinomyces</i> spp.								
<i>A. israelii</i>	(+)	0	0	+	+	0	0	0
<i>A. meyeri</i>	0	0	0	V	0	0	0	0
<i>A. naeslundii</i>	+	0	0	+	V	0	+	0
<i>A. odontolyticus</i>	+	0	0	+	V	0	0	+
<i>A. viscosus</i>	+	+	0	+	V	0	V	0
<i>Cutibacterium</i> spp.								
<i>C. acnes</i>	+	+	+	+	0	0	0	0
<i>C. avidum</i>	+	+	0	0	+	0	0	0
<i>C. granulorum</i>	+	+	0	0	0	0	0	0
<i>Pseudopropionibacterium</i>								
<i>P. propionicum</i>	0	0	0	+	0	0	0	0
<i>Bifidobacterium</i> spp.	V	0 ⁺	0	0	+ ⁰	0	0	0
<i>Eggerthella</i>								
<i>E. lenta</i>	0	+	0	+	0	0	NA	+
<i>Eubacterium</i> spp.	0	0 ⁺	0 ⁺	0	V	0	0	0
<i>Lactobacillus</i> spp.	V	0	0	0 ⁺	V	0	0	0
<i>Mobiluncus</i> spp.	0	0	0	V	0	+	0	0

^a+, positive reaction; +⁰, most strains positive, some negative; (+), better growth under anaerobic conditions; 0, negative reaction; 0⁺, most strains negative, some weakly positive; V, variable reaction; NA, not available.

API ID 32A and the VITEK2 ANC ID card (both from bioMérieux), BBL Crystal Anaerobe ID kits (Becton Dickinson Diagnostic Systems), and RapID Ana II (Thermo Fisher Scientific). The benefits include ease of use and faster turnaround. The limitations include a requirement for a heavy inoculum, with an optical density equivalent to a 3 to 4 MacFarland standard, and the limited number of anaerobic, non-spore-forming Gram-positive bacilli included in the databases. The recommendation is to use a system that correctly identifies

>90% of isolates tested. MALDI-TOF MS has been a major improvement over other methods used for the identification of bacteria, including anaerobes, and has been shown to be more accurate than commercial phenotypic systems. MALDI-TOF MS has the advantage of being able to accurately identify anaerobic, non-spore-forming Gram-positive bacilli that previously could be identified only by 16S rRNA sequencing. In the future, whole-genome sequencing may also be a major contributor to organism identification.

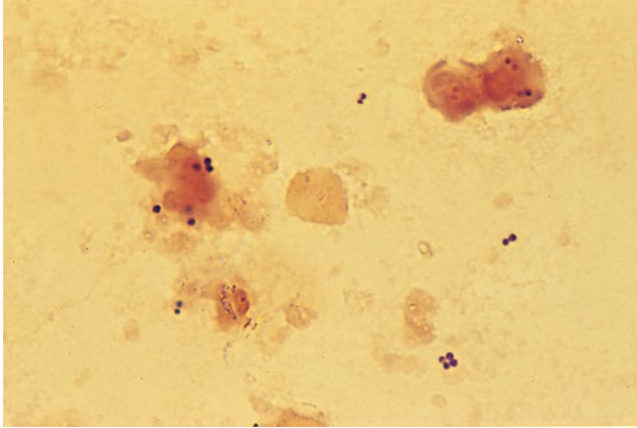


Figure 29-1 Gram stain of a specimen from a femur infected with aerobic and anaerobic Gram-positive cocci. Although the Gram stain can be very useful in suggesting the presence of anaerobes and also in providing a presumptive identification of certain anaerobic organisms, it cannot differentiate between aerobic and anaerobic cocci. In this Gram stain of a specimen from a lesion in the femur, all of the cocci look similar. The culture grew *Staphylococcus aureus* and anaerobic Gram-positive cocci.

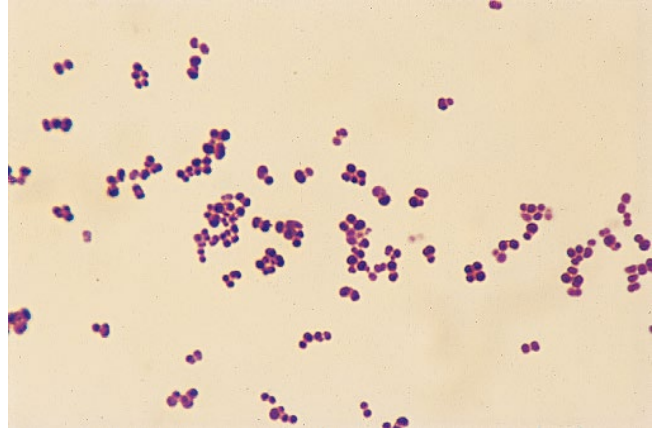


Figure 29-2 Gram stain of *Finegoldia magna*. *F. magna* cells are Gram-positive cocci in pairs or clusters, measuring 0.7 to 1.2 μm in diameter.

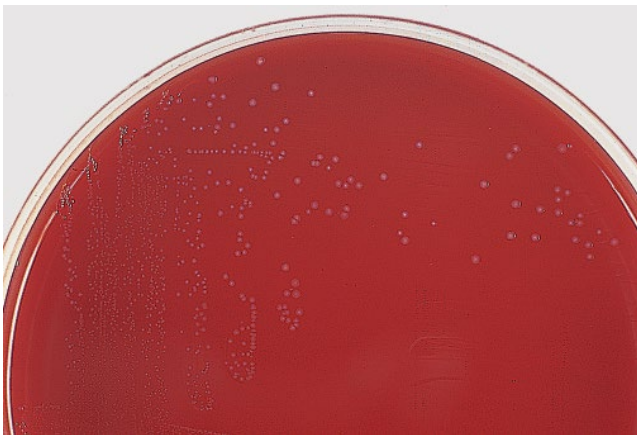


Figure 29-3 *Finegoldia magna* on CDC agar. After 48 h, colonies of *F. magna* are minute to 0.5 mm in diameter, circular, dull, smooth, and nonhemolytic.

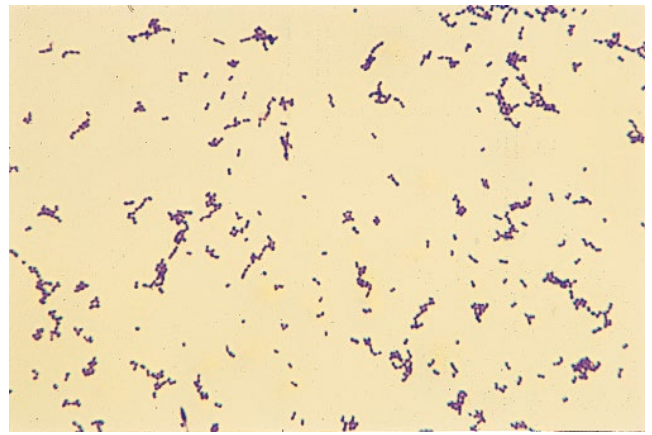


Figure 29-4 Gram stain of *Parvimonas micra*. *P. micra* is among the smallest of the anaerobic Gram-positive cocci. The cells measure 0.3 to 0.7 μm in diameter and usually form pairs or short chains.

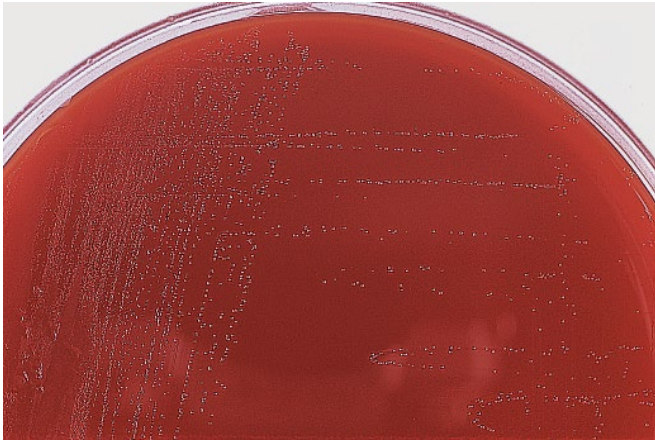


Figure 29-5 *Parvimonas micra* on CDC agar. *P. micra* colonies are circular, convex, white to translucent gray, and opaque. After 48 h of incubation, the colonies are minute to 1 mm in diameter.

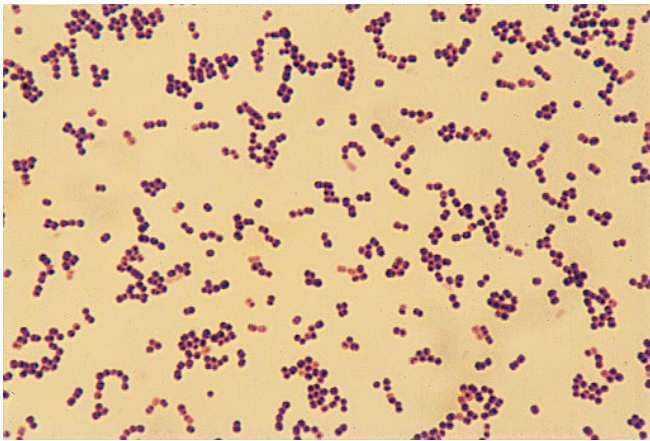


Figure 29-6 Gram stain of *Peptostreptococcus anaerobius*. *P. anaerobius* cells are fairly large, Gram-positive cocci measuring 0.5 to 0.6 μm in diameter. As shown here, the cells often elongate and occur in pairs and chains.

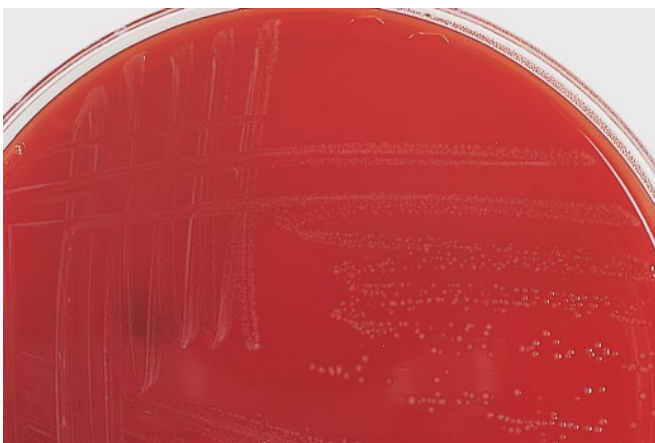


Figure 29-7 *Peptostreptococcus anaerobius* on CDC agar. Colonies of *P. anaerobius* are circular, entire, gray to white, and opaque. They vary in diameter from 0.5 to 2 mm after 48 h of incubation; they are larger than colonies of most other anaerobic Gram-positive cocci. Another characteristic is the sweet, fetid odor associated with this organism.

Figure 29-8 SPS disk test. As shown here, an SPS disk is added to a heavily inoculated subculture plate and incubated anaerobically for 48 h. If the organism is susceptible to SPS, there will be a zone of inhibition (≥ 12 mm) around the disk. The organism on the left is susceptible, and the one on the right is resistant. The disk test is especially valuable for presumptive identification of *Peptostreptococcus anaerobius*, which is susceptible to SPS.

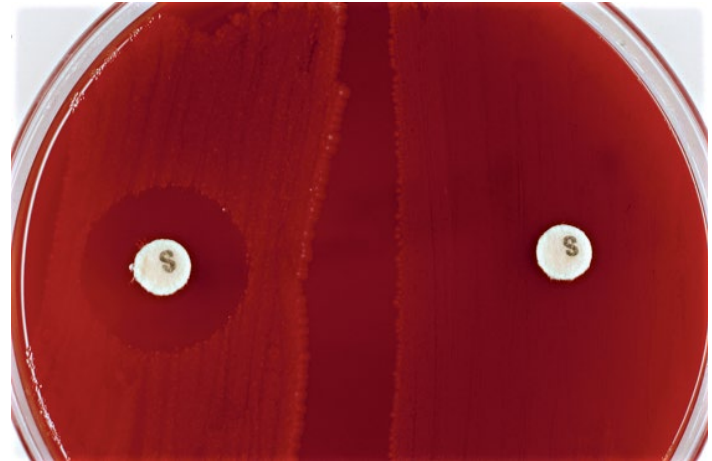


Figure 29-9 Gram stain of *Peptoniphilus asaccharolyticus*. *P. asaccharolyticus* cells are Gram-positive cocci measuring 0.5 to 1.6 μm and can be seen in pairs, tetrads, or irregular clumps. Cells of *P. asaccharolyticus* may also appear Gram negative.

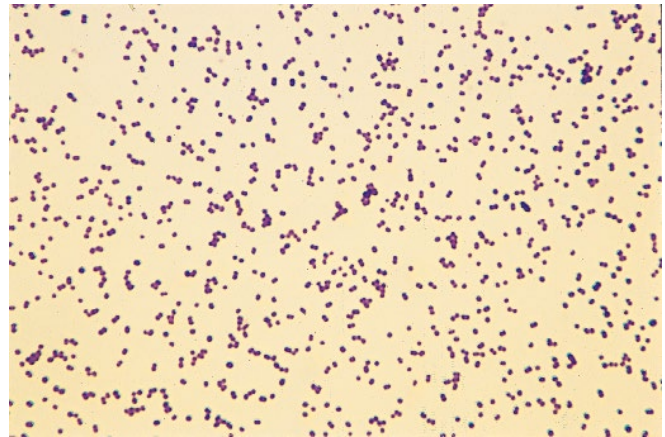
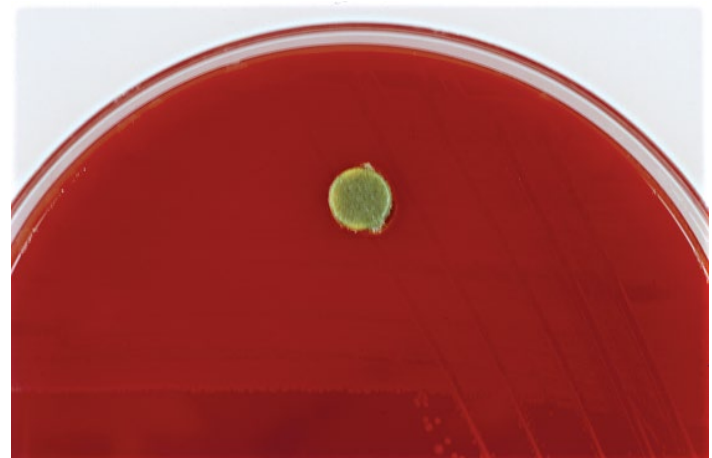


Figure 29-10 Spot indole test used for presumptive identification of *Peptoniphilus asaccharolyticus*. The spot indole test can be performed by placing a blank disk in the area of heavy growth on a subculture plate. After 48 h of incubation under anaerobic conditions, one drop of 1% *p*-dimethylaminocinnamaldehyde is added to the disk. The disk becomes blue to green, as shown here, if the organism produces indole, whereas a pink to orange color indicates a negative test. Anaerobic Gram-positive cocci isolated from human clinical specimens can presumptively be identified as *P. asaccharolyticus* if they are SPS resistant and indole positive. *Peptoniphilus indolicus*, the other anaerobic Gram-positive coccus that is indole positive, is rarely isolated from clinical specimens.



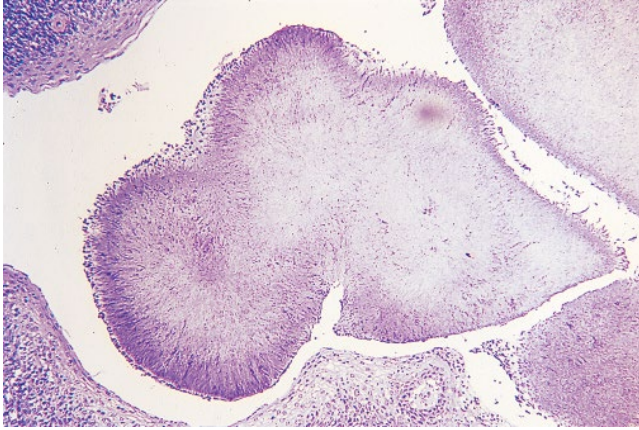


Figure 29-11 Hematoxylin and eosin stain of a sulfur granule from the tonsils. Sulfur granules are a conglomeration of microorganisms that form only *in vivo* and are usually yellow but can also be white, gray, or brown. Sulfur granules range in size from less than 0.1 mm to up to 3 to 5 mm. The granule is composed of delicate branched and beaded filaments embedded in an amorphous material that is brittle, cracks easily, and has essentially the same composition as organisms grown *in vitro*. In the periphery, it is possible to see, at high magnification, the radially oriented filaments terminating in clubs or enlargements; as a result, the name “ray fungus” was used in the past. The Brown-Brenn modification of the Gram stain demonstrates that the filaments are Gram positive. These granules are usually surrounded by acute and chronic inflammatory cells.

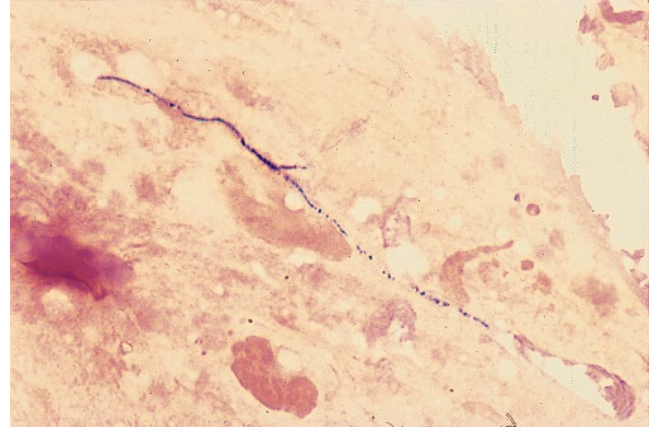


Figure 29-12 Gram stain of *Actinomyces israelii*. *A. israelii* cells are Gram-positive bacilli that can appear club shaped, diphtheroid-like, or as slender filaments with various degrees of true branching. Short filaments can be 1.5 to 5 μm in length, while longer filaments can be 10 to 50 μm or longer. Although *A. israelii* is Gram positive, irregular staining is common and gives rise to a beaded appearance.

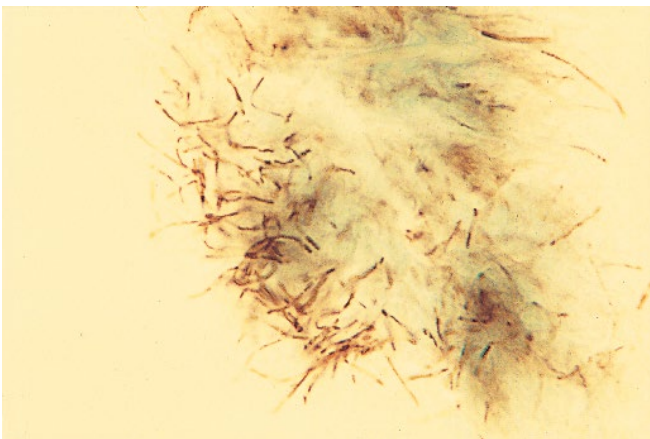
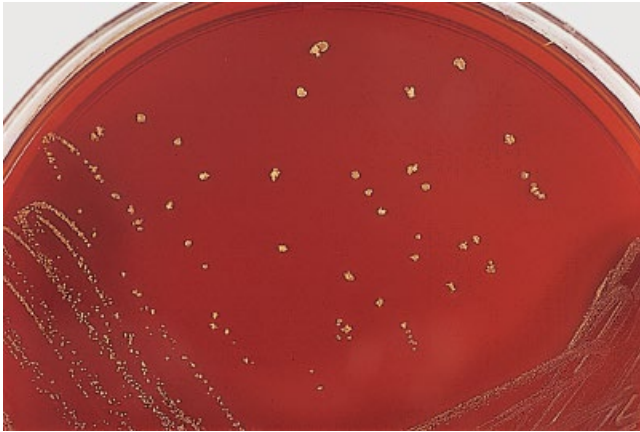


Figure 29-13 Gomori methenamine silver stain of *Actinomyces israelii*. The Gomori methenamine silver stain allows good visualization of the filaments of *A. israelii*, which, as shown here, are long and thin and have a diameter of 1 μm or less. Sections of the organism at different angles can result in the appearance of irregular staining.



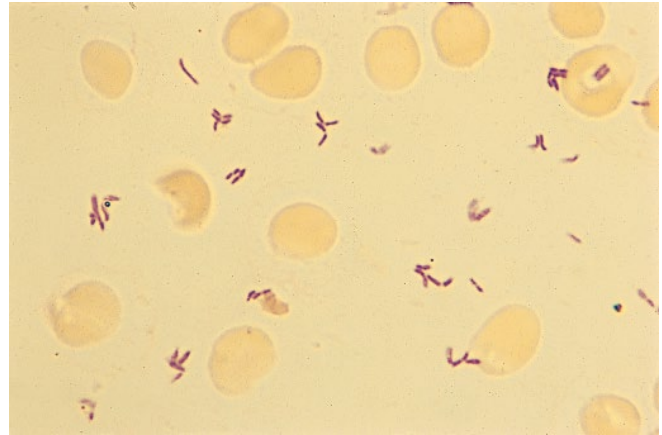
A



B

Figure 29-14 Young colonies (A) and mature colonies (B) of *Actinomyces israelii* on CDC agar. *A. israelii* is microaerophilic and slow growing, often requiring more than 48 h for growth to appear on primary culture. (A) Young colonies of *A. israelii* grown on CDC agar for 72 h appear as small colonies that are spider-like in appearance. (B) After incubation for 7 days, the colonies are opaque and cream or gray-white and have a molar tooth morphology, which is typical of *A. israelii*.

Figure 29-15 Gram stain of *Actinomyces odontolyticus*. *A. odontolyticus* cells are variable in morphology. This Gram-positive bacillus can be small and club shaped or have bifurcated ends. It can also appear as thin filaments. As shown in this Gram stain of a blood culture sample, *A. odontolyticus* cells are pleomorphic, with small bacilli and thin filaments present.





A



B

Figure 29-16 *Actinomyces odontolyticus* on CDC agar. (A) After 48 h, *A. odontolyticus* forms small, opaque, white colonies. (B) The colonies may produce a pink pigment when incubation is extended from 4 to 10 days.

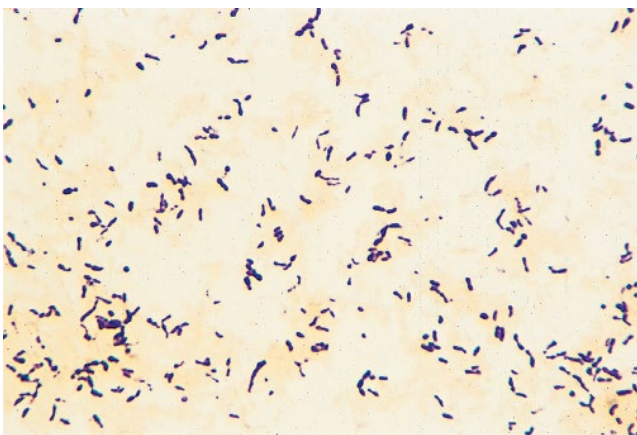


Figure 29-17 Gram stain of *Cutibacterium acnes* from a blood culture. The morphology of *C. acnes* may vary considerably. Cells can measure 0.5 to 0.8 μm by 1.5 μm . They can be diphtheroidal or club shaped with round or tapered ends and can be coccoidal or branching.



Figure 29-18 Aerotolerance of *Cutibacterium acnes*. Like many species of *Actinomyces*, *C. acnes* is microaerophilic. In the cultures shown, *C. acnes* was grown for 48 h on chocolate agar incubated at 35°C in 5 to 10% CO_2 (left) and for 48 h on CDC agar incubated anaerobically (right). Although the organism grows under both conditions, enhanced growth is seen when it is grown anaerobically.



Figure 29-19 Indole and catalase tests for presumptive identification of *Cutibacterium acnes*. A presumptive identification of *C. acnes* can be made if an anaerobic Gram-positive bacillus has a pleomorphic, diphtheroid morphology and is indole positive, as indicated by the blue disk (left), and catalase positive, as shown by the bubbles produced when the organism is added to a drop of hydrogen peroxide (right).

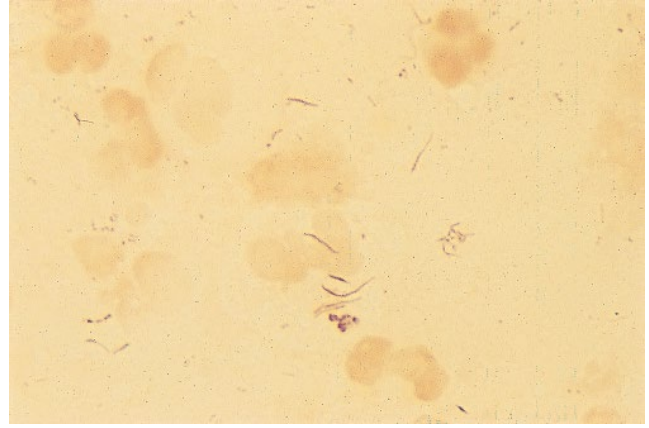


Figure 29-20 Gram stain of *Bifidobacterium dentium*. The cell morphology of *B. dentium* is pleomorphic and can vary from short, thin, faintly staining bacilli with pointed ends to long cells with slight bends and protuberances with club-shaped ends or branching with or without one bifurcated end, or they may appear cocci-dal. They occur singly, in chains, or in palisade arrangements.

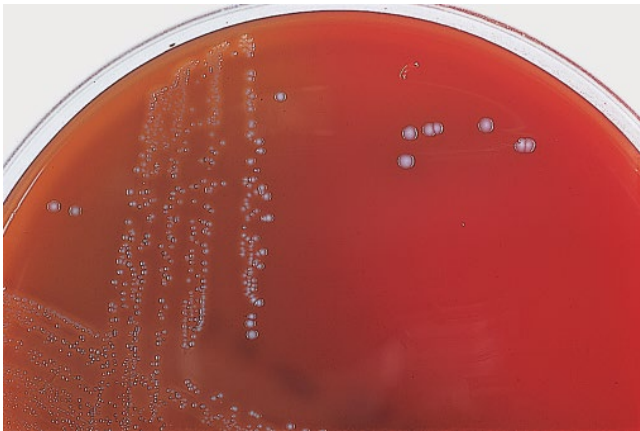


Figure 29-21 *Bifidobacterium dentium* on CDC agar. This culture of *B. dentium* was grown for 48 h on CDC agar. The colonies are entire and cream to white with a smooth, glistening, soft consistency.



Figure 29-22 Gram stain of *Eggerthella lenta*. *E. lenta* cells are small, pleomorphic bacilli measuring 0.2 to 0.4 μm by 0.2 to 2.0 μm . As shown here, they may be diphtheroidal and occur singly, in pairs, or in short chains.



Figure 29-23 *Eggertella lenta* on CDC agar. In the culture shown here, *E. lenta* was grown anaerobically for 3 days on CDC agar. The colonies are small, circular, entire, translucent, and difficult to visualize.

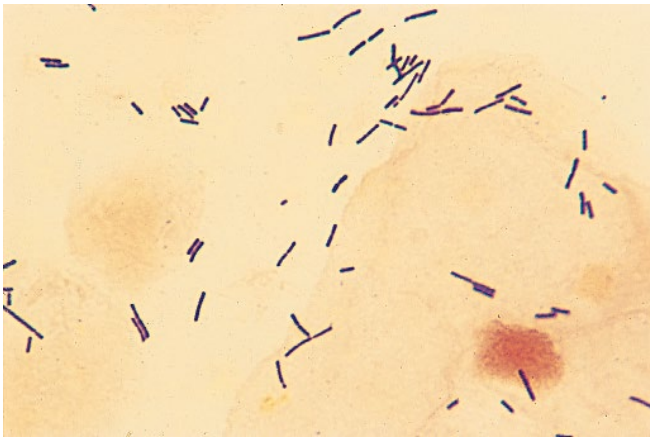


Figure 29-24 Gram stain of *Lactobacillus* spp. The Gram stain shown is from a vaginal specimen. Note the slender, Gram-positive bacilli with parallel sides and blunt ends, which is typical of *Lactobacillus* spp.



Figure 29-25 *Lactobacillus* spp. on CDC agar. After 72 h, anaerobic *Lactobacillus* spp. produce colonies, measuring 2 to 5 mm in diameter, that are convex, entire, smooth, opaque, and nonpigmented.

Figure 29-26 Gram stain of *Mobiluncus* spp. Since routine vaginal cultures for the isolation of *Mobiluncus* spp. are costly, time-consuming, and often not clinically useful, an acceptable alternative is the use of the direct Gram stain to provide a presumptive identification. As shown here, *Mobiluncus* spp. appear as curved bacilli, which consistently stain Gram negative or Gram variable. The absence of lipopolysaccharide in their cell wall and their structural similarity to Gram-positive organisms keep them in this group. Their spinning motility distinguishes them from other anaerobic, non-spore-forming, Gram-positive bacilli.

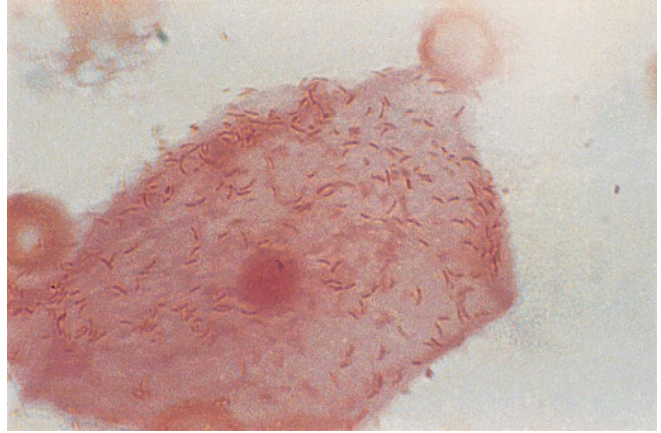
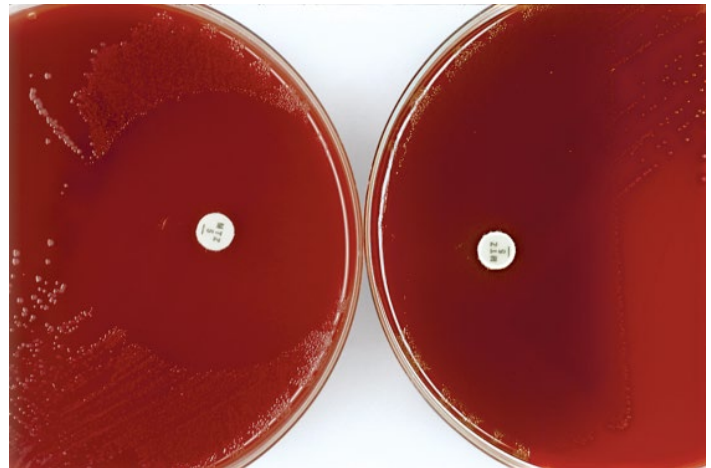


Figure 29-27 Metronidazole disk test. Anaerobic Gram-positive cocci can be reliably differentiated from microaerophilic strains by applying a 5- μ g metronidazole disk to the inoculated plate and incubating for 48 h. Microaerophilic strains show no inhibition, whereas anaerobic cocci demonstrate a zone of inhibition of ≥ 15 mm. The organism on the left is *Peptostreptococcus anaerobius*, an obligate anaerobic coccus, and is surrounded by a large zone of inhibition, and the organism on the right is *Streptococcus sanguinis*, which is microaerophilic and is resistant to the 5- μ g metronidazole disk.



Bacteroides, *Porphyromonas*, *Prevotella*, *Fusobacterium*, and Other Anaerobic Gram-Negative Bacteria

30

As a result of nucleic acid analysis, the taxonomy of the anaerobic, Gram-negative bacteria continues to evolve, with species being renamed and new species being added. *Bacteroides*, *Porphyromonas*, *Prevotella*, and *Fusobacterium* are clinically the most important Gram-negative bacilli. The anaerobic Gram-negative cocci include the genera *Acidaminococcus*, *Anaeroglobus*, *Megasphaera*, and *Veillonella*. Of these, *Veillonella* is the genus most commonly isolated from clinical specimens. Anaerobic Gram-negative bacteria are part of the normal microbiota of the mouth and the upper respiratory, gastrointestinal, and genitourinary tracts of humans and animals. As a result of disease or trauma, they can migrate from their endogenous locations into normally sterile sites.

Although the taxonomic position of several species remains uncertain, the genus *Bacteroides* includes the *Bacteroides fragilis* group and closely related species, which hydrolyze esculin, grow in 20% bile, and are nonmotile. There are currently more than 50 species listed within the *B. fragilis* group, but those most commonly encountered in clinical specimens are *B. fragilis*, *Bacteroides thetaiotaomicron*, and *Bacteroides ovatus*. Clinically, the *B. fragilis* group is important because of the frequent involvement of its members in infections and their resistance to antimicrobial agents. *B. fragilis* is the most common anaerobe that causes bacteremia and has also been recovered from patients with endocarditis, pericarditis, and peritonitis. These organisms can also cause abscesses, which are mainly intra-abdominal, perineal, and perirectal, as well as other

soft tissue infections, such as foot and decubitus ulcers. Bites or trauma can result in life-threatening diseases due to *B. fragilis* infection. Comorbidities, especially colorectal cancer, are risk factors for anaerobic bacteremia.

The pigmented *Prevotella* spp. most frequently encountered in clinical specimens include *Prevotella corporis*, *Prevotella denticola*, *Prevotella intermedia*, *Prevotella loescheii*, and *Prevotella melaninogenica*. Although most commonly found in the oral cavity, *Prevotella bivia* and *Prevotella disiens* have been associated with genitourinary tract infections, and *P. intermedia* (formerly *Bacteroides intermedius*) has been recovered from various body sites. With the development of more sensitive methods of detection and identification, anaerobes are now being found more frequently in the lungs of cystic fibrosis (CF) patients along with organisms such as *Pseudomonas aeruginosa*, which traditionally has been associated with CF patients. In particular, *P. melaninogenica*, *P. denticola*, *Prevotella oris*, and *Prevotella* are frequently found in the lungs of CF patients.

Of the *Porphyromonas* spp., *Porphyromonas asaccharolytica*, *Porphyromonas bennonis*, *Porphyromonas catoniae*, *Porphyromonas endodontalis*, *Porphyromonas gingivalis*, *Porphyromonas somerae*, and *Porphyromonas uenonis* are the ones most frequently isolated from clinical specimens. With the exception of *P. catoniae*, they are pigmented, asaccharolytic, and generally considered pathogens. The most frequent infections involve the oral cavity, but other sites, including the

vagina, amniotic fluid, skin (decubitus ulcers), blood, and brain tissue can also be affected.

Fusobacterium nucleatum is the *Fusobacterium* species most frequently isolated from clinical specimens, including those obtained from the oral cavity, upper respiratory, genital and gastrointestinal tracts, and central nervous system. Individuals with *F. nucleatum* frequently have comorbidities. *Fusobacterium necrophorum* subsp. *funduliforme* (biovar B) is associated with Lemierre's syndrome (necrobacillosis) and can cause severe peritonsillar abscesses that sometimes lead to neck infections, jugular vein thrombophlebitis, and bacteremia, while *Fusobacterium mortiferum* and *Fusobacterium varium* are associated with intra-abdominal infections.

A majority of the chronic infections involving the sinuses, ears, and periodontal region are polymicrobial and predominantly anaerobic. *Prevotella* spp., *Porphyromonas* spp., *Fusobacterium* spp., and *Bacteroides* spp. other than *B. fragilis* are the organisms most commonly isolated from these sites. These organisms also cause brain abscesses, typically in patients with a history of chronic sinusitis or otitis. Infections of the female genital tract, including endometritis and pelvic inflammatory disease, usually involve mixtures of anaerobes including *P. bivia* and *P. disiens*.

Anaerobic Gram-negative cocci account for only a small portion of the anaerobic bacteria isolated from human clinical specimens. *Veillonella* is the genus most commonly isolated, and *Veillonella parvula* is the most common species recovered. Although *Veillonella* spp. are frequently identified in polymicrobial cultures, they are rarely the only etiological agent isolated in serious infections. *Veillonella atypica*, *Veillonella dispar*, and *V. parvula* are found mainly in the oral cavity. Risk factors for *Veillonella* infections include periodontal diseases, premature birth, intravenous drug use, and immunodeficiencies.

To isolate and characterize these organisms, specimens must be collected and transported anaerobically

for optimal recovery. Direct examination of the clinical material is also important in the initial determination of the presence of anaerobes. When the direct smear is being prepared, use of carbol fuchsin as the counterstain in the Gram stain procedure will enhance staining of the Gram-negative anaerobes. For primary isolation, a combination of selective and differential media is used. In general, it is recommended that nonselective media such as brucella or CDC anaerobe blood agar containing vitamin K₁ and hemin, kanamycin–vancomycin–laked-blood (KVLB) agar, and bacteroides bile esculin (BBE) agar be used. This combination of media will facilitate the isolation and presumptive identification of the *B. fragilis* group and *Bilophila* spp.

Most of the clinically significant anaerobic Gram-negative bacilli can be placed in broad groups, and some can be presumptively identified by using special-potency antibiotic disks containing vancomycin (5 µg), kanamycin (1 mg), and colistin (10 µg), along with a few simple tests, such as those for growth in bile and indole, catalase, nitrate, urea, and pigment production. The characteristics that differentiate the most common clinical species are listed in Table 30-1, and the characteristics of the most common species in the *B. fragilis* group are listed in Table 30-2. Many of these tests are incorporated into the three Presumpto Quad plates developed at the Centers for Disease Control and Prevention (CDC) to aid in the identification of anaerobic bacteria. Anaerobic Gram-Negative ID Quad (Thermo Scientific Remel Products, Lenexa, KS) most closely corresponds to CDC Presumpto Plate 1. It contains kanamycin, esculin, bile, and tryptophan and is helpful in identifying *Bacteroides* and *Fusobacterium* spp. Definitive identification of most anaerobic Gram-negative bacilli requires additional biochemical tests, metabolic end-product analysis, or characterization of cell wall fatty acids. New methods, including matrix-assisted laser desorption ionization-time of flight mass spectrometry (MALDI-TOF MS) and nucleic acid amplification techniques, are being introduced to help identify these organisms.

Table 30-1 Characteristics of the most common anaerobic Gram-negative bacilli isolated from clinical specimens^a

Species	Cell morphology	Vancomycin (5 µg)	Kanamycin (1 mg)	Colistin (10 µg)	Growth in 20% bile	Catalase	Indole	Nitrate	Urea	Pigment
<i>Bacteroides</i> spp.										
<i>B. fragilis</i> group	Short	R	R	R	+	V	V	0	0	0
Other <i>Bacteroides</i> spp.	Variable	R	R	V	V	V	V	0	0	0
<i>Fusobacterium</i> spp.										
<i>F. mortiferum</i>	Pleomorphic with large round bodies	R	S	S	+	0	0	0	0	0
<i>F. necrophorum</i>	Pleomorphic	R	S	S	V	0	+	0	0	0
<i>F. nucleatum</i>	Slender, long	R	S	S	0	0	+	0	0	0
<i>F. varium</i>	Large with rounded ends	R	S	S	+	0	V	0	0	0
Pigmented species										
<i>Prevotella</i> spp.	Coccobacillary	R	R ^S	V	0	0	V	0	0	+
<i>Porphyromonas</i> spp.	Variable	S	R	R	0	V	V	0	0	+ ^b
<i>Veillonella</i> spp.	Small cocci	R	S	S	0	V	0	+	0	0

^aS, susceptible; R, resistant; R^S, resistant, rarely susceptible; +, positive reaction; V, variable reaction; 0, negative reaction.

^b*P. catoniae* is the only nonpigmented *Porphyromonas* sp.

Table 30-2 Characteristics of the most common species within the *B. fragilis* group^a

Species	Esculin hydrolysis	Catalase	Indole	Arabinose	Salicin
<i>B. fragilis</i>	+	+	0	0	0
<i>B. ovatus</i>	+	+	+	+	+
<i>B. thetaiotaomicron</i>	+	+	+	+	0
<i>B. vulgatus</i>	0	0	0	+	0

^a+, positive reaction; 0, negative reaction.

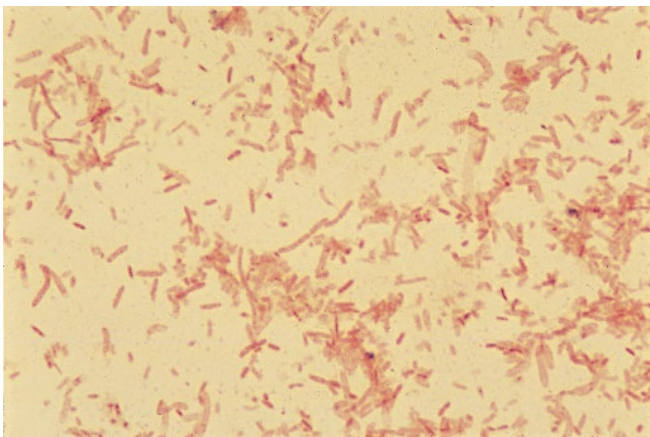


Figure 30-1 Gram stain of *Bacteroides fragilis* using carbol fuchsin as the counterstain. Members of the *B. fragilis* group are irregularly staining, pleomorphic, Gram-negative bacilli that vary in length. They can appear elongated or as coccobacilli and occur singly or in pairs. Staining is enhanced when carbol fuchsin is used as the counterstain in the Gram stain procedure.

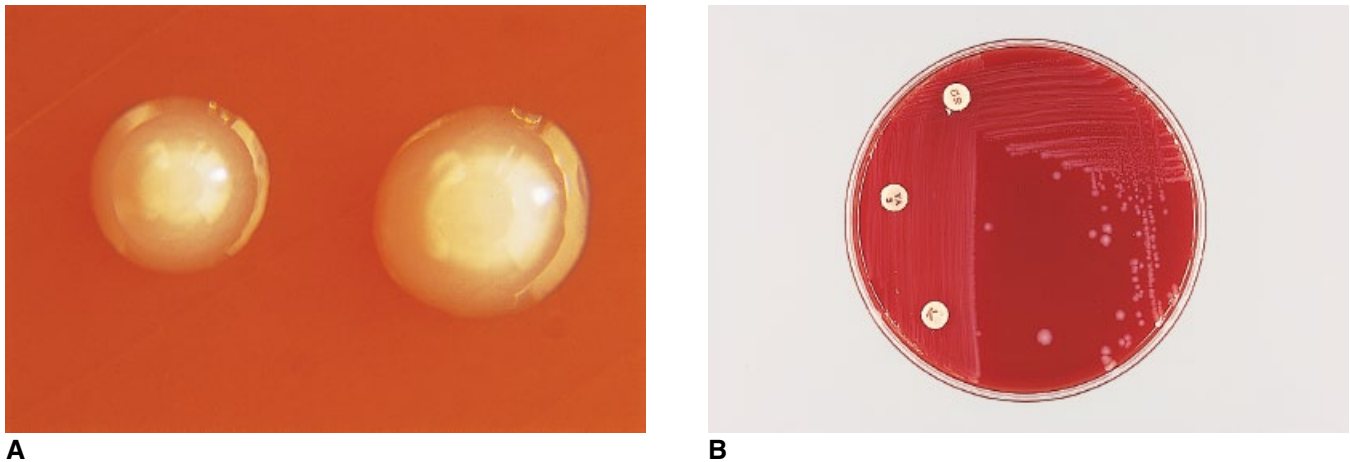


Figure 30-2 *Bacteroides fragilis* growing on CDC agar (A) and presumptive identification of the *B. fragilis* group by using special-potency antimicrobial disks (B). After 48 h of incubation, colonies of *B. fragilis* on CDC agar are 1 to 3 mm in diameter, circular, entire, convex, and gray to white. Hemolysis can vary, with some strains exhibiting beta-hemolysis. (A) When *B. fragilis* colonies are viewed by obliquely transmitted light, concentric rings or whorls are visible. (B) The *B. fragilis* group is characterized by resistance (a zone diameter of 10 mm or less) to all three special-potency antimicrobial disks: kanamycin (1 mg), vancomycin (5 µg), and colistin (10 µg).

Figure 30-3 *Bacteroides fragilis* on KVLB agar and BBE agar. *B. fragilis* is not inhibited by kanamycin or vancomycin and thus exhibits good growth on KVLB agar (left). Another characteristic is its ability to grow in 20% bile and hydrolyze esculin, causing browning of the BBE agar (right).



Figure 30-4 *Bacteroides fragilis* and *Bacteroides vulgatus* on BBE agar. A characteristic shared by members of the *B. fragilis* group is their ability to grow in 20% bile and hydrolyze esculin. *B. vulgatus* is the exception. While it can grow in bile, it cannot hydrolyze esculin. Note the dark colonies of *B. fragilis* and the blackening of BBE agar (right), in contrast to the growth of, but lack of esculin hydrolysis by, *B. vulgatus* (left).

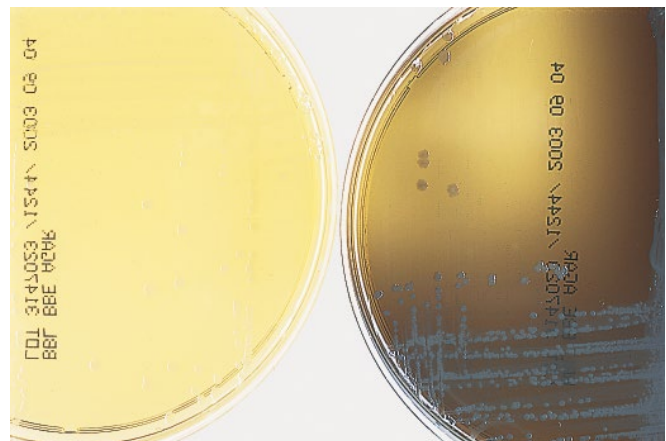


Figure 30-5 Spot indole test. The spot indole test can be performed directly on a pure culture by placing a sterile blank disk on an area of heavy growth. After several minutes, one drop of 1% *p*-dimethylaminocinnamaldehyde is added to the disk. The disk turns blue to green if the organism produces indole. As shown here, *Bacteroides thetaiotaomicron* gives a positive reaction (left), while *Bacteroides fragilis* gives a negative reaction (right). The spot indole test can be a useful rapid test for identifying species within the group.

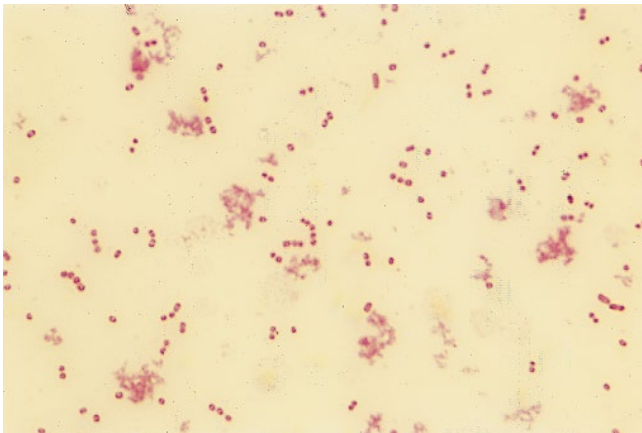
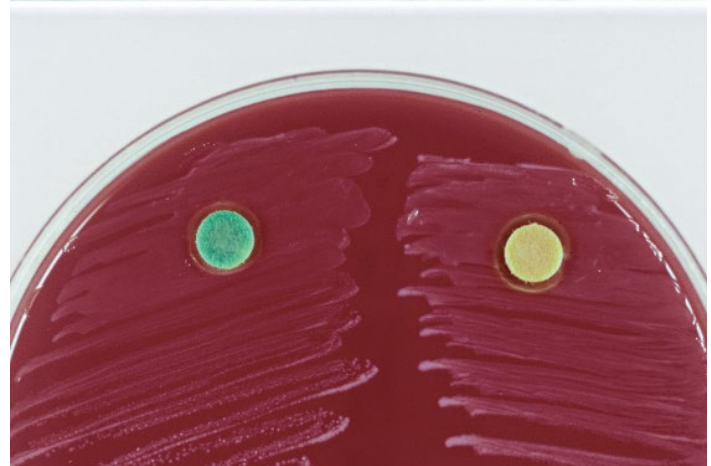


Figure 30-6 Gram stain of *Prevotella melaninogenica* with carbol fuchsin as the counterstain. The Gram stain morphology of *Prevotella* spp. is similar to that of *Bacteroides* spp. *Prevotella* organisms are small, Gram-negative bacilli or coccobacilli measuring 0.5 to 0.8 μm by 0.9 to 2.0 μm . Note the almost spherical appearance of the cells, which are arranged in pairs and short chains. The blood culture shown here grew *P. melaninogenica*.



Figure 30-7 *Prevotella corporis* on CDC agar and KVLB agar. Colonies of *P. corporis* are shown after 72 h of growth on CDC agar (left) and KVLB agar (right). The disk pattern for *Prevotella* spp., unlike the *B. fragilis* group, is kanamycin and vancomycin resistant but can be either resistant or susceptible to colistin. Note the enhanced pigment production on KVLB agar.

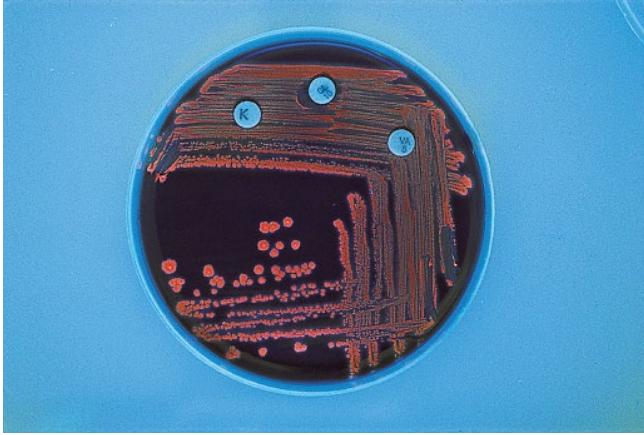


Figure 30-8 Fluorescence of a *Prevotella* species growing on CDC agar. Many *Prevotella* strains require up to 3 weeks for the pigment to appear. However, fluorescence can be detected within 48 to 72 h by exposing the colonies to long-wave UV light. Note the typical brick-red fluorescence of this pigment-producing *Prevotella* species.



Figure 30-9 Anaerobic Gram-Negative ID Quad. The Anaerobic Gram-Negative ID Quad system corresponds to CDC Presumpto Plate 1 and contains the following media: quadrant I, kanamycin agar (top); quadrant II, Lombard-Dowell agar for detection of indole (right); quadrant III, esculin agar for detection of esculin hydrolysis and catalase activity (bottom); and quadrant IV, bile agar (left). The Quad plates shown were inoculated with *B. fragilis* and *P. melaninogenica*. *B. fragilis* (left plate) grows on kanamycin agar (top), hydrolyzes esculin (bottom), and grows on bile agar (left), while *P. melaninogenica* (right plate) grows on kanamycin agar, does not hydrolyze esculin, and cannot grow in bile. *B. fragilis* is catalase positive, *P. melaninogenica* is catalase negative, and both organisms are indole negative.

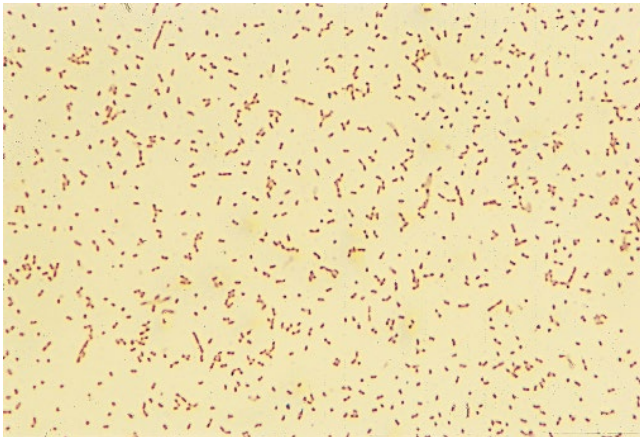


Figure 30-10 Gram stain of *Porphyromonas* sp. from CDC agar with a carbol fuchsin counterstain. *Porphyromonas* sp. is a Gram-negative bacillus measuring 0.4 to 0.6 μm by 1 to 2 μm . Longer cells are occasionally present, and shorter, almost spherical cells can be seen when the organism is grown on solid media, as in this Gram stain of a 48-h culture of *Porphyromonas* sp.

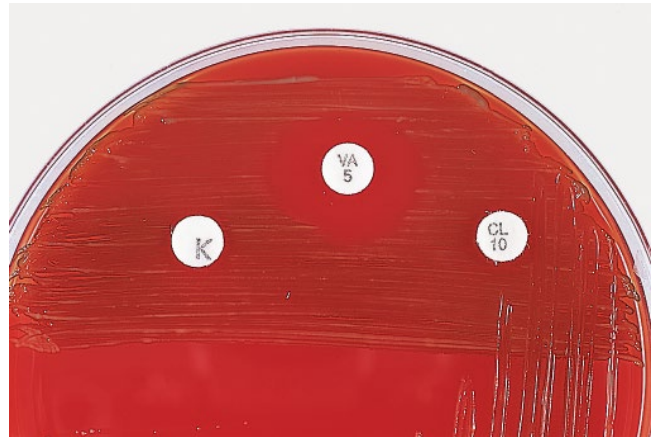


Figure 30-11 *Porphyromonas* spp. on CDC agar. Unlike *Prevotella*, *Porphyromonas*, as shown here, is susceptible to vancomycin and resistant to kanamycin and colistin.

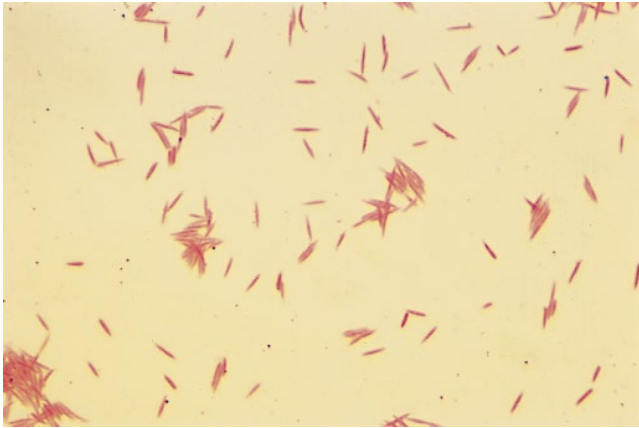


Figure 30-12 Gram stain of *Fusobacterium nucleatum* with a carbol fuchsin counterstain. *F. nucleatum* appears as long, thin, Gram-negative bacilli with tapered ends. It is the only *Fusobacterium* sp. that consistently demonstrates this fusiform morphology.

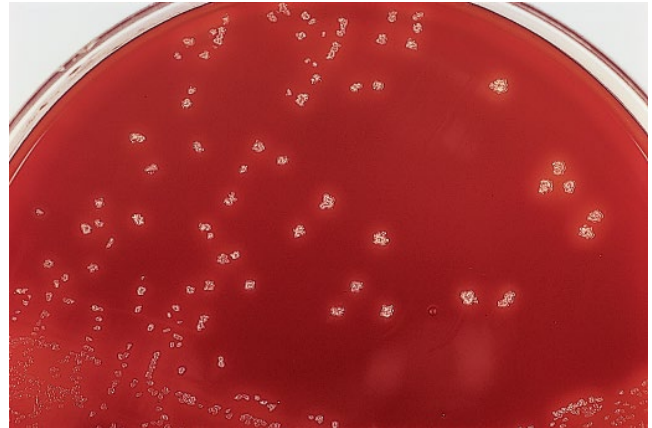


Figure 30-13 *Fusobacterium nucleatum* on CDC agar. *F. nucleatum* produces small, irregularly shaped colonies (often described as resembling bread crumbs).

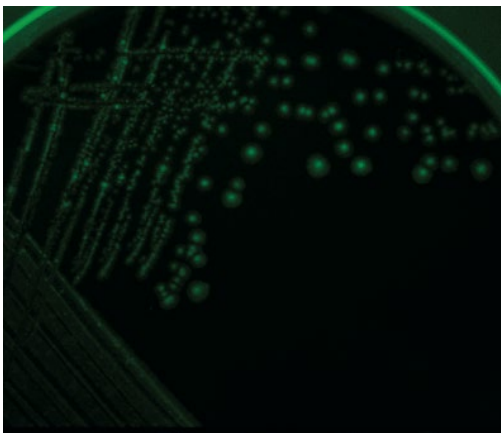


Figure 30-14 Fluorescence of *Fusobacterium* spp. *Fusobacterium* fluoresces chartreuse when exposed to long-wave UV light.

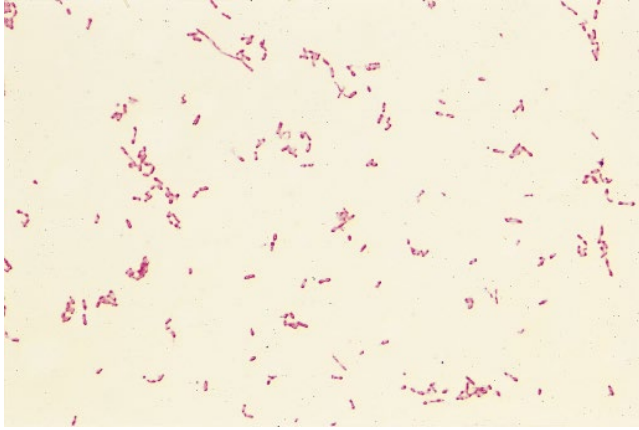


Figure 30-15 Gram stain of *Fusobacterium necrophorum* with a carbol fuchsin counterstain. *F. necrophorum* bacteria are pleomorphic, long, Gram-negative bacilli, measuring 0.5 to 0.7 μm by 10 μm , with round or tapered ends. They can vary from coccoid to long filaments depending on the medium and age of the culture. Filamentous forms are more common in broth cultures, whereas rod-like forms are frequently seen in older cultures or when the organism is grown on agar, as shown here.

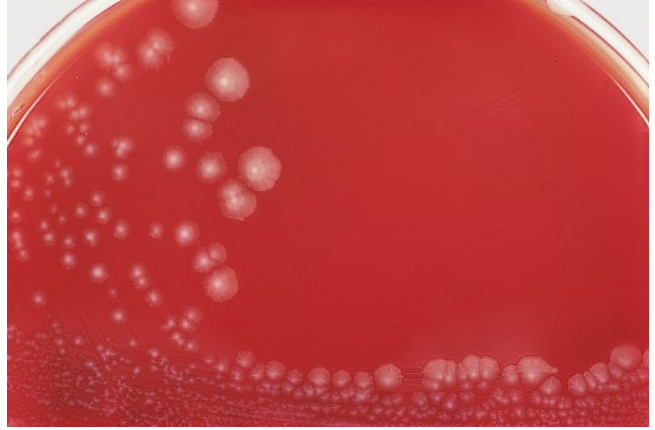


Figure 30-16 *Fusobacterium necrophorum* on CDC agar. After 48 h of incubation, *F. necrophorum* produces umbonate, circular, glistening, white to tan colonies on CDC agar.



Figure 30-17 *Fusobacterium necrophorum* on egg yolk agar. As shown here, *F. necrophorum* is lipase positive. Note the mother-of-pearl sheen on the surface of the egg yolk agar.

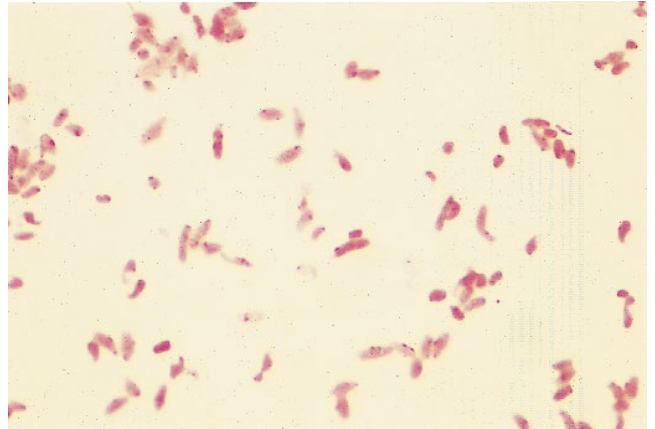


Figure 30-18 Gram stain of *Fusobacterium mortiferum* with a carbol fuchsin counterstain. Cells of *F. mortiferum* are 0.8 to 1.0 μm by 1.5 to 10 μm and appear as Gram-negative bacilli. Note the extreme pleomorphism and irregular staining.



Figure 30-19 *Fusobacterium mortiferum* on BBE agar. Because *F. mortiferum* is bile tolerant and hydrolyzes esculin, it can be mistaken for a member of the *B. fragilis* group. Note the growth of dark colonies and blackening of the BBE agar.

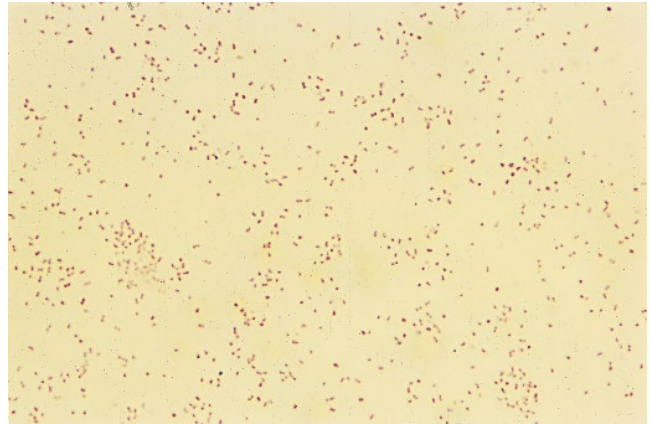


Figure 30-20 Gram stain of *Veillonella* spp. *Veillonella* spp. are tiny, Gram-negative cocci, measuring 0.3 to 0.5 μm in diameter. They may appear as diplococci or in short chains or clumps.



Figure 30-21 *Veillonella parvula* on CDC agar. After 48 h of incubation, *Veillonella* colonies are small (1 to 3 mm in diameter), entire, opaque, and nonhemolytic.

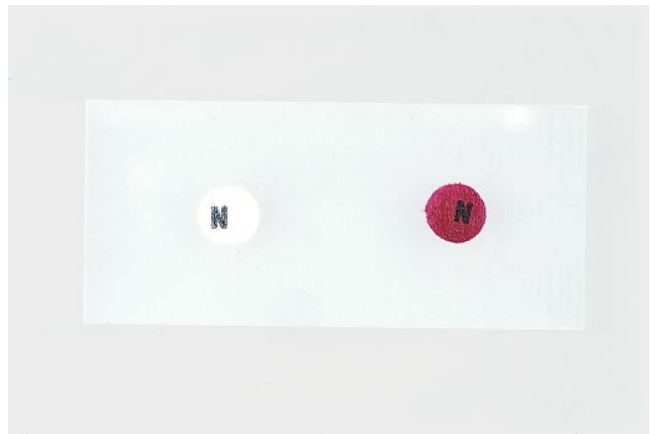


Figure 30-22 Nitrate disk test. The nitrate disk is a miniature version of the conventional tube nitrate reduction test used for identification of aerobic bacteria. The disk is placed on the heavily inoculated first quadrant of a culture, which is incubated anaerobically for 24 to 48 h. One drop each of nitrate reagent A (*N,N*-dimethylnaphthylamine) and reagent B (sulfanilic acid) is added to the disk. If the test is negative, no color develops (left). A positive reaction is indicated by the development of a red color (right), indicating that the nitrate was reduced to nitrite. As with the conventional test, zinc dust can be added if the initial result is negative, to determine if nitrate was reduced beyond nitrite. The nitrate test can be used to presumptively identify anaerobic Gram-negative bacilli such as *B. ureolyticus* and tiny, anaerobic Gram-negative cocci such as *Veillonella* spp.

Campylobacter and *Arcobacter*

31

Two genera, *Campylobacter* and *Arcobacter*, are included in the family *Campylobacteraceae*. The genus *Campylobacter* includes 40 species and the genus *Arcobacter* comprises 29 species. *Campylobacter* spp. are primarily zoonotic, affecting poultry, cattle, sheep, pigs, and domestic animals.

Campylobacter jejuni subsp. *jejuni* (referred to here as *C. jejuni*) is recognized as the most common bacterial enteric pathogen in the world, with approximately 1 to 2 million cases occurring yearly in the United States. This organism causes sporadic infections during summer and early fall as a result of ingestion of improperly handled food (primarily poultry products), raw milk, and water. Two age groups are frequently affected: young children and adults aged 20 to 40 years. The clinical presentation ranges from asymptomatic to severe with fever, abdominal cramps, and diarrhea that may be bloody and may last for several days or weeks. Relapses are observed in 5 to 10% of cases. The most severe presentations occur in immunocompromised patients and in the elderly. Extraintestinal involvement and chronic sequelae occur in certain cases; they include bacteremia, reactive arthritis (Reiter's syndrome), bursitis, meningitis, endocarditis, and abortion. A clinical presentation similar to acute appendicitis may result in unnecessary surgery. *C. jejuni* is the most common infectious agent associated with Guillain-Barré syndrome.

Campylobacter coli produces the same clinical picture as *C. jejuni* and probably accounts for 5 to 10% of the cases of diarrhea due to campylobacters. In underdeveloped countries, *C. coli* may be a more common

pathogen than *C. jejuni*. *Campylobacter fetus* subsp. *fetus* causes bacteremia and extraintestinal infections, particularly in individuals with underlying diseases or in those who are pregnant or immunocompromised. *Campylobacter lari* and *Campylobacter upsaliensis* have also been isolated from patients with diarrhea and bacteremia. The pathogenic role of *Campylobacter ureolyticus* in humans is still under investigation, although it has been implicated in infections, e.g., gastrointestinal. Two of the 29 species of *Arcobacter*, *Arcobacter butzleri* and *Arcobacter cryaerophilus*, have been isolated from humans with diarrhea and bacteremia.

For hospitalized patients, it is recommended that stool specimens for routine bacterial culture be rejected when collected more than 72 h after admission. For direct examination of stool specimens suspected of harboring *Campylobacter*, the use of carbol fuchsin or aqueous basic fuchsin as the counterstain in the Gram stain is recommended. Organisms in the genus *Campylobacter* are Gram-negative, curved, "seagull wing"-shaped, motile, non-spore-forming bacilli that measure 0.2 to 0.9 μm wide by 0.5 to 5.0 μm long. They have a typical darting motility, resulting from a single polar flagellum, when observed under phase-contrast microscopy. In addition, polymorphonuclear leukocytes may be seen in direct smears.

There are several commercially available antigen tests for the detection of *Campylobacter* in stool samples. Compared with culture, the sensitivity of these assays ranges from 80 to 96%, and although their specificity is usually >97%, they have poor positive predictive values due to the relatively low incidence of this infection.

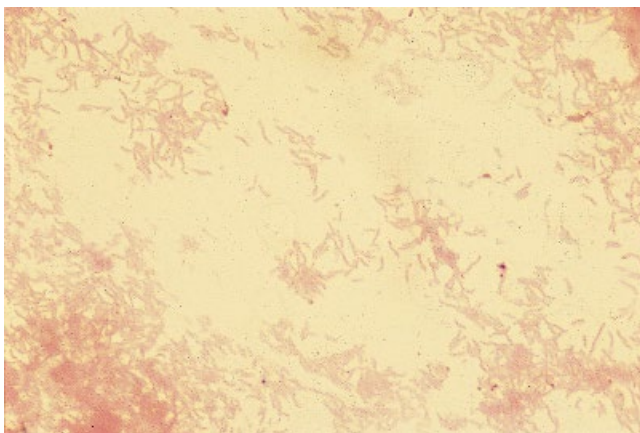
Nucleic acid detection techniques and matrix-assisted laser desorption ionization-time of flight mass spectrometry are now commercially available for detection and identification. Campylobacters are microaerophilic, although some strains grow both aerobically and anaerobically. Some species of *Campylobacter*, such as *Campylobacter sputorum*, *Campylobacter concisus*, and *Campylobacter mucosalis*, require a gas mixture with more than 2% hydrogen for growth and isolation. Most of these organisms can grow at 42°C.

Members of the genus *Arcobacter* are referred to as aerotolerant campylobacters because they can grow in the presence of atmospheric concentrations of oxygen. These organisms grow at temperatures ranging from 15 to 37°C but do not grow at 42°C. Other characteristics useful in distinguishing them from *Campylobacter* spp. include hydrolysis of indoxyl acetate and inability to hydrolyze hippurate. *C. jejuni* and *C. coli* are indoxyl acetate positive, while *C. fetus* subsp. *fetus* is negative.

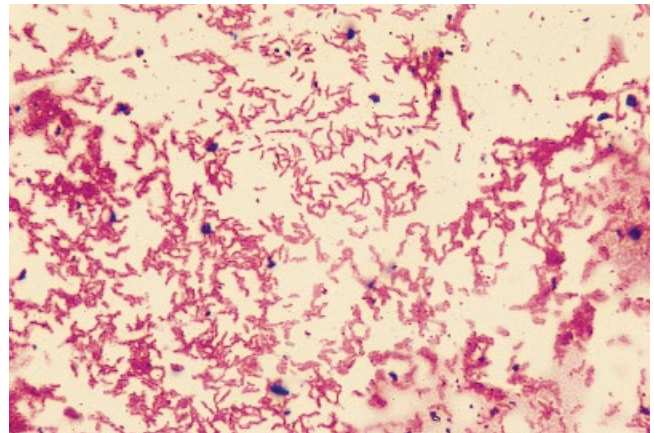
Several types of media can be used to recover these organisms from clinical specimens. *Campylobacter* blood agar (Campy BAP) contains a brucella agar base, sheep blood, and a combination of the following antibiotics: vancomycin, trimethoprim, polymyxin B, amphotericin B, and cephalothin. Campy CVA (cefoperazone, vancomycin, and amphotericin) medium,

charcoal cefoperazone deoxycholate agar, and charcoal-based selective medium (CSM) can also be used for isolation of these organisms. For optimal recovery, the inoculated plates should be incubated in a microaerobic environment containing 5 to 7% O₂, 5 to 10% CO₂, and 80 to 90% N₂. These conditions can be achieved by using commercially available microaerobic gas generator packs. It should be noted, however, that the candle jar does not provide these conditions. In cases where *C. jejuni* is suspected, the plates should be incubated at 42°C to favor the growth of the organism and suppress the growth of the intestinal microbiota. On the other hand, if *C. fetus* subsp. *fetus* is suspected, the plates should be incubated at 37°C and 25°C. *C. upsaliensis* is susceptible to the antibiotics used to isolate campylobacters, and as a result, it is not recovered on these media. Culture conditions for recovery of *Arcobacter* from clinical specimens are not defined.

In addition to the typical Gram stain morphology, growth characteristics at different temperatures and under different atmospheric conditions, darting motility, catalase and oxidase production, hippurate hydrolysis, indoxyl acetate hydrolysis, production of H₂S, and susceptibility to antibiotics are the most useful tests for identification of campylobacters.



A



B

Figure 31-1 Gram stain of *Campylobacter jejuni* counterstained with safranin (A) and carbol fuchsin (B). Campylobacters are slender, long, curved, pleomorphic, Gram-negative bacilli. As shown here, short chains of organisms have a typical “seagull wing” appearance. Safranin, as used in the routine Gram stain, results in very faint staining of these organisms. The morphology of *C. jejuni* is better defined on a Gram stain counterstained with carbol fuchsin rather than safranin.

Figure 31-2 Gram stain of *Campylobacter fetus* from a blood culture. *C. fetus* causes bacteremia and extraintestinal infections in immunocompromised patients.

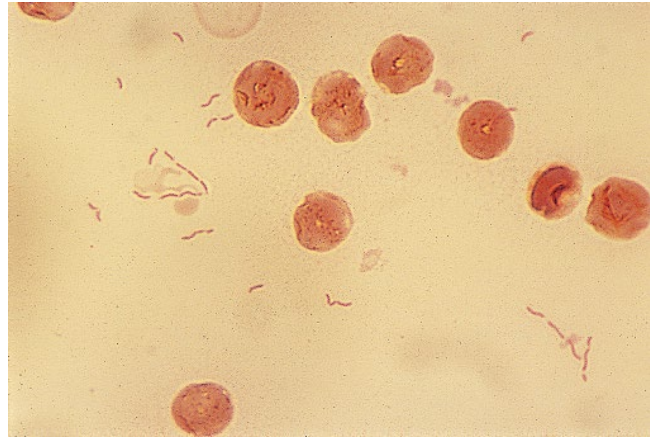


Figure 31-3 Para-Pak C&S. The Para-Pak C&S (culture and sensitivity) system (Meridian Bioscience, Inc., Cincinnati, OH) is a system for the collection and transportation of bacterial enteric pathogens including *Campylobacter* spp. The 30-ml plastic vial contains 15 ml of modified Cary-Blair transport medium and uses phenol red as an indicator. This isotonic, nonnutritive medium preserves the viability of enteric pathogens and minimizes the overgrowth by commensal organisms. A change in color of the medium from red to yellow indicates overgrowth and improper storage of the specimen.

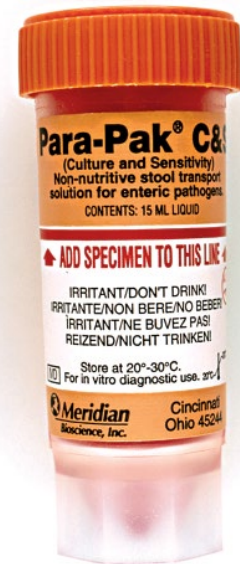


Figure 31-4 GasPak EZ gas-generating pouch system. The GasPak EZ gas-generating pouch system (BD Diagnostic Systems, Franklin Lakes, NJ) shown here provides an atmosphere suitable for the growth of campylobacters. The GasPak gas-generating sachet contains all the components needed to produce specific atmospheric conditions to optimize the recovery of *Campylobacter* spp. Two petri dishes can be inserted into the pouch for incubation.





Figure 31-5 *Campylobacter jejuni* on Campy CSM medium. Charcoal-based selective medium Campy CSM agar (Quebact Laboratories Inc., Montreal, Canada) is a blood-free medium useful for the isolation of *C. jejuni*. This medium contains cefoperazone, vancomycin, and cycloheximide to inhibit the growth of other fecal organisms. As shown in this figure, *C. jejuni* produces white-gray, glistening, round colonies on CSM agar.



Figure 31-6 *Campylobacter jejuni* on Campy BAP medium. On Campy BAP agar, the colonies of *C. jejuni* may be gray and flat, although some are raised, irregular, dry or moist, runny looking, and spreading along the streak lines.

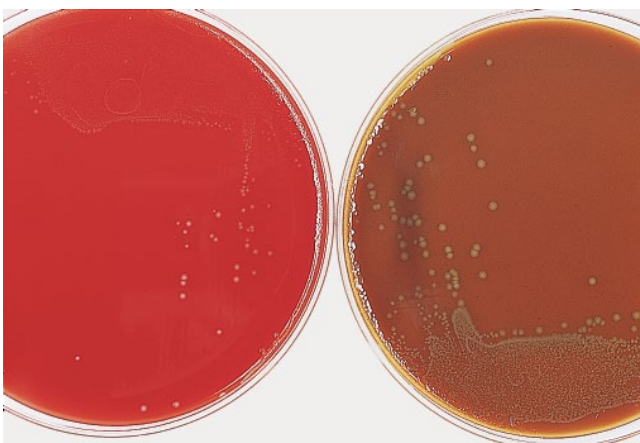


Figure 31-7 *Campylobacter fetus* on blood agar (left) and chocolate agar (right). *C. fetus* is not a thermophilic organism. Media should be incubated at 37°C under microaerophilic conditions. As shown here, *C. fetus* grows better on chocolate agar than on blood agar and forms colonies that are gray and flat and measure 1 to 2 mm in diameter after 48 h of incubation.



Figure 31-8 *Campylobacter jejuni* on a triple sugar iron (TSI) slant with a lead acetate strip. *C. jejuni* gives a positive H_2S reaction on lead acetate paper but is nonreactive for H_2S production on a TSI agar slant. *C. fetus* subsp. *fetus* and *C. fetus* subsp. *venerealis* give the same type of reaction. In contrast, *C. sputorum* and *C. mucosalis* give positive H_2S reactions on a TSI agar slant.

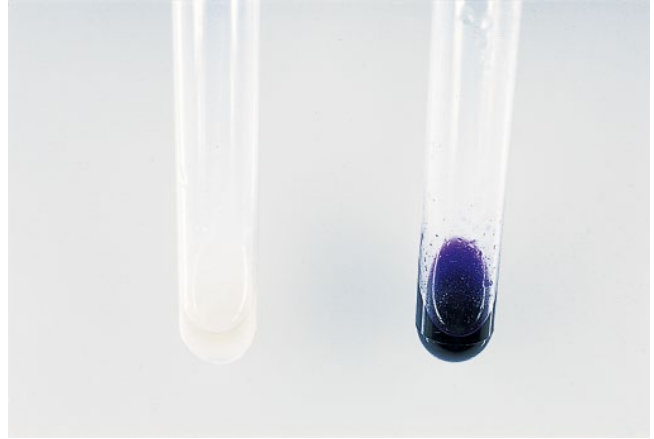


Figure 31-9 Hippurate hydrolysis test for *Campylobacter jejuni*. *C. jejuni* is the only *Campylobacter* species that hydrolyzes hippurate. *C. coli* (left) gives a negative reaction, while *C. jejuni* (right) gives a positive reaction.

Figure 31-10 ImmunoCard STAT! Campy. The ImmunoCard STAT! Campy (Meridian Bioscience, Inc.) is a rapid assay for the detection of *Campylobacter* antigens in stools. This immunochromatographic test uses monoclonal antibodies specific for an antigen present in both *C. jejuni* and *C. coli*. The stool sample is added to a diluent buffer and applied to the sample port. When the sample moves through the card, the *Campylobacter* antigen binds to the monoclonal antibody-colloidal gold conjugate. A capture monoclonal antibody bound to the membrane in the central window of the device binds the antigen-*Campylobacter* antibody-colloidal gold complex, resulting in a pink-red line. The control line of the assay shows that the sample has migrated through the device and that the test reagents are working. The test on the left is a negative result while the test on the right is positive.





Figure 31-11 *Campylobacter ureolyticus* on CDC agar. *C. ureolyticus* is slow growing; its colonies are small and translucent to transparent and measure 1 mm in diameter. As shown here, the colony morphology is variable. Note the smooth, circular, and convex colonies as well as the spreading colonies. In some areas, pitting of the agar can also be observed.



Figure 31-12 Urea test for the presumptive identification of *Campylobacter ureolyticus*. The BBL Taxo urea differentiation disk (BD Diagnostic Systems, Franklin Lakes, NJ) can be used as a rapid method of determining urea hydrolysis. A suspension of the organism is prepared in 0.5 ml of sterile water. Upon addition of a urea disk, the bacterial suspension is incubated aerobically for up to 4 h. A color change to pink indicates a positive reaction. Positive urease production is an important test used to differentiate *C. ureolyticus* (left) from other anaerobic Gram-negative, pitting bacilli, such as *Campylobacter gracilis* (right).

Helicobacter

32

There are almost 40 *Helicobacter* species, and several of them, such as *Helicobacter pylori*, *Helicobacter fennelliae*, and *Helicobacter cinaedi*, are human pathogens. The gastric helicobacters include *H. pylori*, which affects the stomach, while the enterohepatic helicobacters, such as *H. fennelliae*, are found in the intestine but rarely cause infections in humans. Large, spiral, gastric bacteria previously called “*Gastrospirillum hominis*” are currently named *Helicobacter heilmannii*-like organisms and also cause human disease.

In developed countries, 30 to 60% of the adult population is colonized with *H. pylori*, while in developing countries, the prevalence is 70 to 90%. Most of the infections are acquired during childhood by the oral-oral or the fecal-oral route. In addition to humans, *H. pylori* can infect animals, including monkeys, cats, dogs, cattle, swine, horses, rodents, chickens, dolphins, and whales. *H. pylori* can cause a wide range of clinical manifestations. It has been associated with chronic gastritis, peptic ulcer, gastric adenocarcinoma, and a B-cell mucosa-associated lymphoid tissue (MALT) lymphoma, the only cancer that can be cured with antibiotics.

Interestingly, colonization with *H. pylori* may offer some protection against gastroesophageal reflux and adenocarcinomas of the lower esophagus and gastric cardia. *H. fennelliae* and *H. cinaedi* have been isolated from the feces of patients with AIDS, and they may cause proctitis, enteritis, and bacteremia. *H. heilmannii* infections in humans are rare (0.3 to 6%) but are frequently found in pets, including dogs and cats; these animals may also be infected with other zoonotic species, mainly *Helicobacter*

salomonis, *Helicobacter felis*, and *Helicobacter suis*. *H. heilmannii* produces milder gastritis than *H. pylori* and is more common in children. *H. heilmannii* has also been associated with gastric carcinoma and MALT lymphoma. Coinfections with *H. pylori* can occur.

H. pylori is a Gram-negative, spiral, curved or straight microaerophilic bacillus with 1 to 6 unipolar flagella and measures 2.5 to 5.0 μm in length by 0.5 to 1.0 μm in width. The spiral shape is frequently observed in gastric biopsy specimens; however, when cultured on solid media, the bacterium can have a rod-like shape that on prolonged incubation may assume a coccoid form.

H. heilmannii is a large Gram-negative, 3.0 to 7.5 μm in length by 0.6 to 0.9 μm in width, helical, tightly coiled bacillus with up to nine spirals, resembling a spirochete. It is motile, has 4 to 12 sheathed bipolar flagella, and is strongly urease positive. *H. heilmannii* does not grow well *in vitro*, and therefore, its identification depends on microscopic analysis.

H. pylori requires complex media for growth. Chocolate, brain heart infusion, and brucella agars, supplemented with horse or rabbit blood, are good nonselective media, while Thayer-Martin agar, Pylori agar, and Dent's medium have been used as selective media. Colonies from primary cultures usually appear in 2 to 5 days at 37°C in a humid atmosphere with low levels of oxygen (5 to 10%) and increased levels of carbon dioxide (5 to 12%), and they are small (1 to 2 mm in diameter), translucent, and nonhemolytic. Cultures should be incubated for a minimum of 10 days before a negative result is reported.

Presumptive identification of *H. pylori* should be based on Gram stain characteristics and positive catalase, oxidase, and rapid urease reactions (Table 32-1). *H. cinaedi* and *H. fennelliae* are oxidase and catalase positive but urease negative. Susceptibility to nalidixic acid and the ability to reduce nitrate can also be used to differentiate between *Helicobacter* species.

A gastric biopsy specimen can be cultured, as described above, and can also be probed with a rapid urease method. For example, in the *Campylobacter*-like organism (CLO) test, the specimen is placed in a gel that contains urea. The urease produced by the *H. pylori* rapidly hydrolyzes the urea, yielding ammonia, which results in a change in the color of the indicator. Histological examination using hematoxylin and eosin, special stains such as a modified Giemsa stain, or the Warthin-Starry silver stain can also be used for identification of *H. pylori* in gastric biopsy specimens. Using monoclonal and polyclonal antibodies, immunohistological staining can be performed to improve sensitivity and specificity of detection; however, cross-reactivity with *H. heilmannii* has been described. Currently, histological examination is the gold standard for the diagnosis of an *H. pylori* infection.

There are several approaches that do not require an endoscopy for diagnosis of an infection with *H. pylori*.

These include serological testing, the urea breath test (UBT), and stool antigen detection. Immunoglobulin G antibodies may persist for several months after eradication of the organism. Thus, serological testing cannot be used to establish the presence of a current infection, although for untreated symptomatic patients, the specificity of this assay is very high. In successfully treated patients, there should be a significant decline of antibody titers over a period of 6 to 12 months. However, this test is not recommended for posttreatment follow-up. To perform the UBT, the patient drinks urea labeled with ^{13}C or ^{14}C and the amount of labeled CO_2 exhaled, resulting from the hydrolysis of the urea by *H. pylori* urease, is quantitated. To perform direct detection tests, stool specimens can be tested for *H. pylori* using nucleic acid amplification techniques, enzyme-linked immunosorbent assays, or similar methods. Antigen detection tests can help in the diagnosis of *H. pylori* infections, and if the UBT is not available, they can be used for confirmation of eradication following treatment.

Nucleic acid detection methods, including PCR and next-generation sequencing, are available in research settings. The currently FDA-approved databases for matrix-assisted laser desorption ionization-time of flight mass spectrometry do not include *H. pylori*.

Table 32-1 Biochemical reactions of *Helicobacter* species^a

Species	Oxidase	Catalase	Urease	Nitrate reduction	Nalidixic acid
<i>H. pylori</i>	+	+	+	0	R
<i>H. cinaedi</i>	+	+	0	+	S
<i>H. fennelliae</i>	+	+	0	0	S
<i>H. heilmannii</i>	+	+	+	+	R

^aR, resistant; S, susceptible; +, positive reaction; 0, negative reaction.

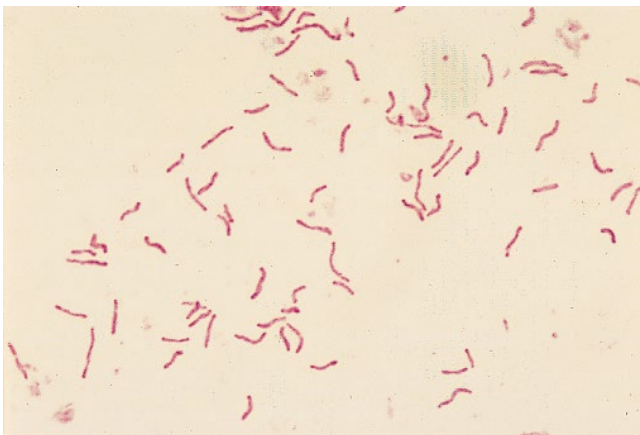


Figure 32-1 Gram stain of *Helicobacter pylori* grown on Thayer-Martin medium. As shown here, *H. pylori* is a Gram-negative bacillus with an S-shaped, “seagull wing” appearance.

Figure 32-2 Gram stain of a touch preparation from a gastric biopsy specimen positive for *Helicobacter pylori*. Touch preparations of gastric biopsy material do not require fixation and thus can provide a rapid diagnosis. These preparations are made by simply pressing the fresh biopsy tissue against a glass slide. To enhance the staining of the organisms, the sample in this figure was counterstained with carbol fuchsin.

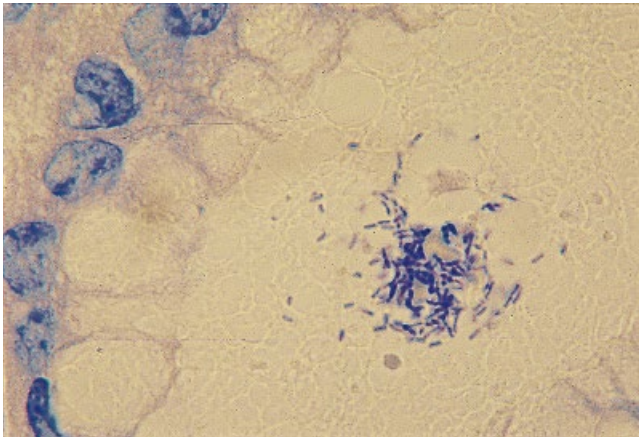
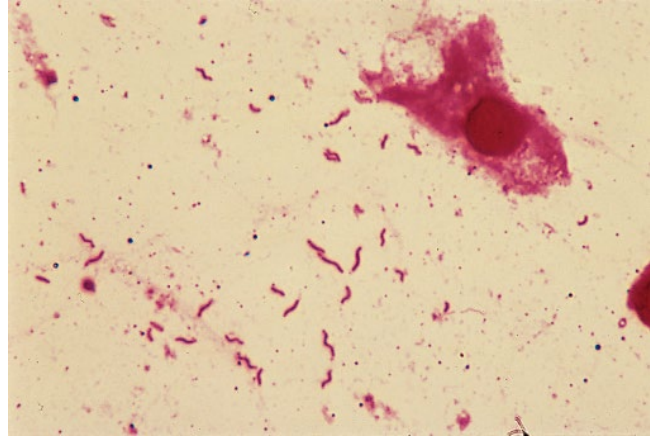
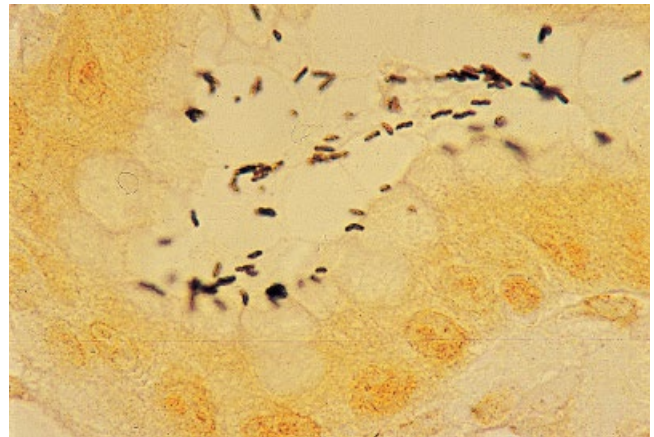
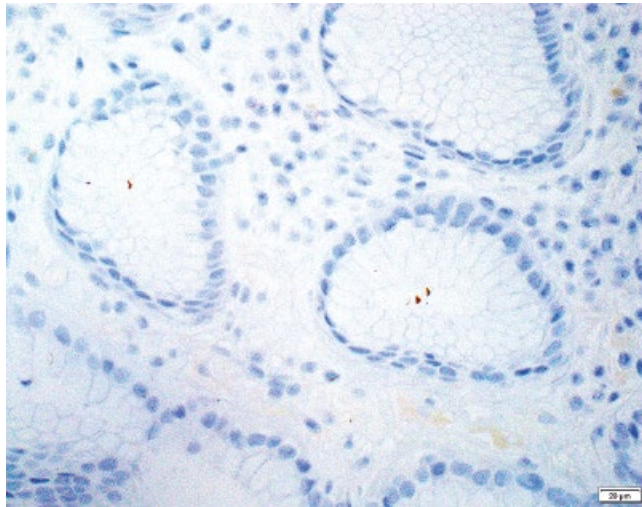
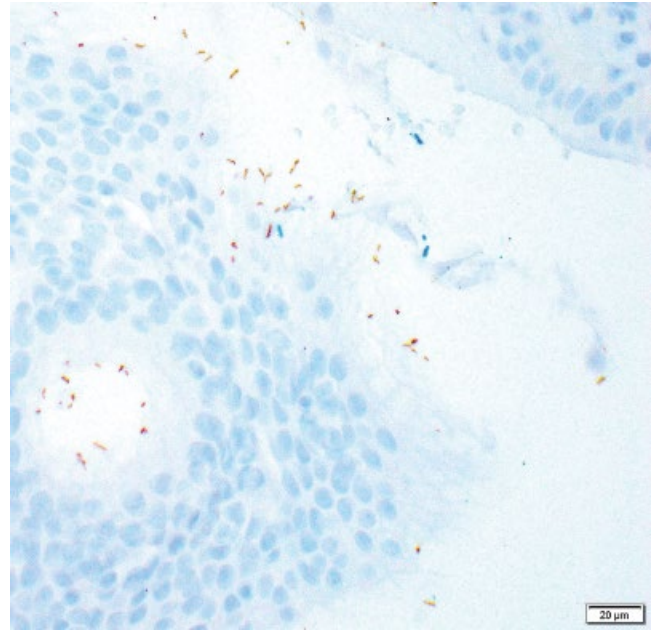
**A****B**

Figure 32-3 Gastric biopsy specimen for *Helicobacter pylori* stained with Giemsa (A) and Warthin-Starry silver (B) stain. To facilitate the visualization of the bacteria, this gastric biopsy specimen was stained with Giemsa or Warthin-Starry silver stain. *H. pylori* can readily be detected as slender, curved bacilli in these gastric biopsy specimens.



A

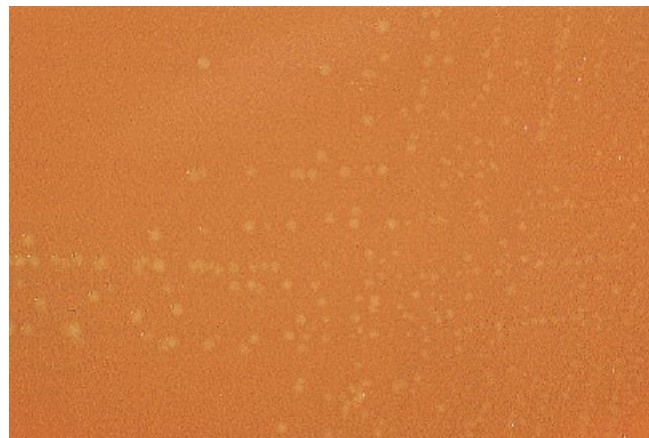


B

Figure 32-4 Immunohistochemical stain of gastric biopsy samples showing *H. pylori* (A) and *H. heilmannii* (B). Human gastric biopsy samples were stained with a monoclonal antibody to *H. pylori*. As shown in these two images, there is cross-reactivity between *H. pylori* and *H. heilmannii*. *H. heilmannii* is longer and has more spirals (six to eight) than *H. pylori* (none to three).



A



B

Figure 32-5 *Helicobacter pylori* on Thayer-Martin medium. Colonies of *H. pylori* may require 4 to 7 days of incubation. As shown here, the colonies are small, round, and translucent. (A) Life size; (B) closeup.

Figure 32-6 The CLOtest for gastric biopsy tissue. *Helicobacter pylori* produces large amounts of urease that can be detected rapidly by placing a tissue biopsy specimen on a medium containing urea. A pH indicator included in the CLOtest (Kimberly-Clark Ballard Medical Products, Draper, UT) makes the medium turn magenta if urease is present (bottom), while the control remains yellow (top).



Figure 32-7 Detection of *Helicobacter pylori* antigen by an enzyme immunoassay. Stool specimens can be tested for the presence of *H. pylori* antigen by enzyme immunoassays such as the Premier Platinum HpSA Plus (Meridian Bioscience, Inc., Cincinnati, OH). In this test, the qualitative detection of *H. pylori* antigen in human feces is based on the use of monoclonal antibodies. This assay is highly specific and sensitive and has the advantage that no invasive procedures are needed to obtain the specimen. It can be used for diagnostic purposes and also to monitor the response to antimicrobial therapy. A rapid antigen detection test, the ImmunoCard STAT! HpSA test, is available from the same company.



Chlamydia

Members of the genus *Chlamydia* are obligate intracellular bacteria. Three species are human pathogens: *Chlamydia trachomatis*, *Chlamydia pneumoniae*, and *Chlamydia psittaci*.

All *Chlamydia* spp. exist in two main forms, the elementary body (EB) and the reticulate body (RB). The EB, which is 0.3 μm in size, is the extracellular, infective, “spore-like” form of this organism. Once the EB enters a susceptible host cell, it becomes located in a cytoplasmic inclusion and undergoes a structural and metabolic conversion to an RB, which is about three times the size of an EB. The RB is metabolically active and undergoes binary fission. At some point in its maturation, the RB condenses, eventually reorganizing back into an EB. Depending on the species and the culture conditions, *in vitro* this cycle can take 36 to 72 h. Once the cycle is complete, the infected host cell releases the EBs, which can then initiate another round of infection.

The three species differ in their epidemiology and disease spectrum. Members of the species *C. trachomatis* can be divided into different serotypes—A through K, Ba, L1, L2, and L3—based primarily on antigenic differences in the major outer membrane protein (MOMP). These different serotypes are also associated with a particular clinical presentation. *C. trachomatis* is the leading cause of preventable blindness in the world. Blindness resulting from trachoma usually occurs in underdeveloped countries. The scarring of the eyelid and conjunctiva, as well as the pannus, resulting in blindness is thought to be due to both immune and mechanical damage to the host from repeated exposure and infection by

this pathogen. More commonly, serotypes A, B, Ba, and C can be isolated from the eye in settings of endemic trachoma. In developed countries, *C. trachomatis* is the leading cause of sexually transmitted bacterial disease, affecting primarily the urethra and cervix. Infants born to infected mothers may be exposed to this organism at birth, and ocular and respiratory infections may result. In addition, females may develop pelvic inflammatory disease after contracting a *C. trachomatis* genital infection, with infertility and ectopic pregnancy as sequelae. Individuals may also develop conjunctivitis and pharyngitis through contact with infected secretions. The most common serotypes isolated from genital infections are D through K. Lymphogranuloma venereum, a more systemic and aggressive sexually transmitted infection, is caused by serotypes L1, L2, and L3. While not common in the United States, this infection is prevalent in Africa.

C. pneumoniae is transmitted between humans via respiratory secretions. This organism is a common cause of community-acquired pneumonia and has been found in focal outbreaks, for example, in boarding schools and military camps. It has also been implicated as a contributing factor to chronic diseases such as asthma, atherosclerosis, strokes, Alzheimer’s disease, and multiple sclerosis. However, the role, if any, this pathogen plays in these chronic conditions is controversial, since a causal relation has not been proven.

C. psittaci is primarily an animal pathogen, with humans acquiring the infection as a zoonosis. Domestic birds are the primary reservoir of human exposure to

C. psittaci. The main manifestation of an infection by this organism in humans is pneumonia, which can develop into a fatal systemic infection. *C. psittaci* is classified as a category B bioterrorism agent and a biosafety level 3 pathogen.

Several laboratory methods are available to aid in the diagnosis of a *Chlamydia* infection. Until the introduction of nucleic acid amplification tests (NAATs), the gold standard for the laboratory diagnosis of *Chlamydia* was cell culture; however, today NAATs are the preferred methods. For culture, specimens are usually obtained with a swab to optimize the collection of infected epithelial cells. The specimens are then transported in a holding medium such as 2-sucrose phosphate (2-SP). Commonly used host cells for the isolation of *C. trachomatis* and *C. psittaci* include HeLa and McCoy cells; while both cell lines also support the growth of *C. pneumoniae*, some investigators prefer to use either HEp-2 or HL cells to isolate this species. There is no standard isolation procedure, but most methods rely on infecting cells raised in either shell vials or microtiter plates. Centrifugation, DEAE pretreatment of cell monolayers, addition of a eukaryotic cell protein synthesis inhibitor (e.g., cycloheximide), and blind passage or repeated centrifugation are common methods used to enhance the recovery of *Chlamydia*. In general, cultures are incubated for 48 to 72 h, or up to 7 days if a blind passage is used before the cultures are examined. The most sensitive stains used to detect inclusions in infected cell monolayers consist of fluorescence-tagged monoclonal antibodies directed at either the lipopolysaccharide, which detect all three species of *Chlamydia*, or the MOMP, which detect *C. trachomatis*. In a positive culture, intracellular cytoplasmic inclusions are present. Because of the fastidious nature of *Chlamydia*, the sensitivity of culture is lower than that of NAATs. However, in medical-legal cases, culture remains the method of choice because of its high specificity compared with amplification methods.

As mentioned above, NAATs are the most common methods employed for the laboratory diagnosis of *C. trachomatis* infections. This is due to the relatively high sensitivity and specificity of the commercially available methods and the ability to test urine and self-collected vaginal samples; therefore, specimen collection is more convenient for both males and females. In addition, NAATs lend themselves to automation, thus facilitating high-volume testing, and testing for *Neisseria gonorrhoeae* can be performed in parallel from the same specimen.

Other rapid methods for the diagnosis of a *C. trachomatis* infection include a direct fluorescent-antibody stain (DFA) and enzyme immunoassays (EIAs). Both types of assays have low sensitivities compared with culture and NAATs. Compared with culture, the sensitivity of these assays, depending on many variables including the population examined and the culture technique used for comparison, has been reported to vary from 50 to 90%. In general, EIAs are not recommended for diagnosis, but the DFA has been found to be useful in the diagnosis of neonatal conjunctivitis, where the organism burden is high. For the diagnosis of *C. pneumoniae* and *C. psittaci*, alternatives to culture are not readily available; however, NAATs have been used in research settings for both organisms. *C. pneumoniae* is included in some commercial multiplex NAAT respiratory syndromic panels.

Serological testing has been used as an epidemiological tool to investigate *Chlamydia* infections. The microimmunofluorescence assay (MIF) is the gold standard of *Chlamydia* serological testing. In this assay, preparations of formalin-fixed EBs are used as the antigen. Individual fluorescent EBs are interpreted as a positive test. This assay suffers from reproducibility problems due to the reagents and the subjectivity inherent in reading the results. EIA and inclusion immunofluorescence assays have been developed, but their use has been limited. An additional limitation of serological tests for *Chlamydia* is the lack of definition of an acute versus a past or chronic infection.

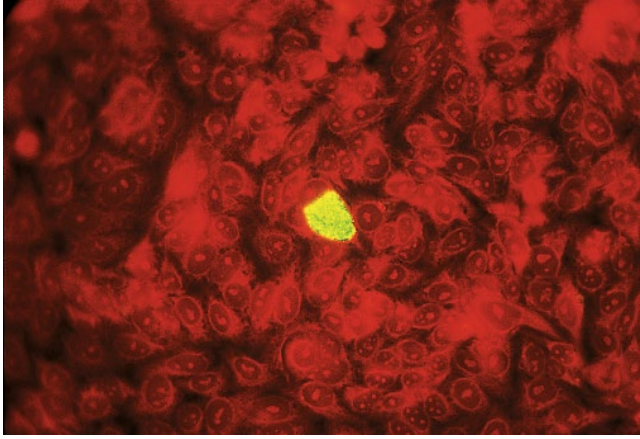


Figure 33-1 Positive cell culture for *Chlamydia trachomatis*. HeLa 229 cells propagated in shell vials were inoculated with a cervical specimen that was transported at 4°C in 2-SP medium. The shell vials were centrifuged for 1 h at 1,000 × g at 35 to 37°C. After centrifugation, cycloheximide (1 µg/ml) was added to the culture, which was then incubated for 48 h at 35 to 37°C. The monolayer was then fixed with ethanol and stained with a monoclonal antibody to the MOMP of *C. trachomatis*. A single large, apple green-fluorescent intracytoplasmic inclusion, against the red background of the Evans blue counterstain, can be seen taking up the majority of the host cytoplasm of the infected cell.

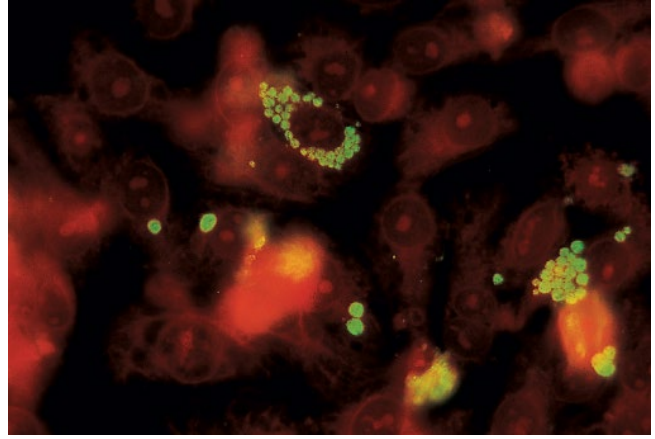


Figure 33-2 Positive cell culture for *Chlamydia pneumoniae*. HEP-2 cell monolayers in shell vials were inoculated with a throat specimen transported in 2-SP medium. Prior to inoculation, the cells were treated with DEAE-dextran (30 µg/ml). The culture was centrifuged for 1 h at 1,000 × g at 35 to 37°C. After the centrifugation, cycloheximide (1 µg/ml) was added to the culture, which was incubated for 72 h at 35 to 37°C. The monolayer was fixed with ethanol and stained with a genus-specific lipopolysaccharide monoclonal antibody tagged with fluorescein isothiocyanate. *C. pneumoniae* takes longer than *C. trachomatis* to complete its intracellular developmental cycle and tends to form multiple distinct inclusions within a single cell. The inclusions appear bright apple green against the red background of the Evans blue counterstain. The microscopic field shown contains cells with multiple inclusions.

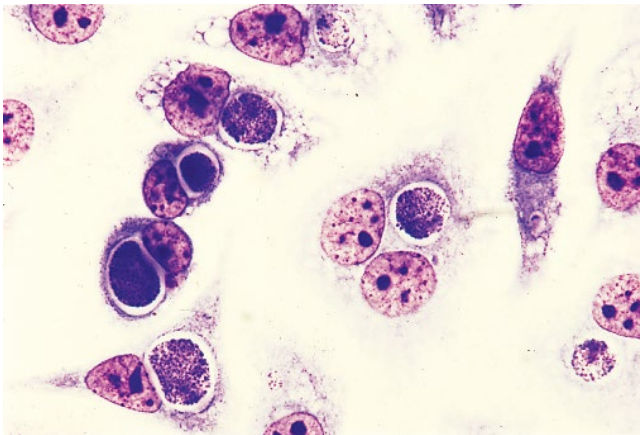


Figure 33-3 Giemsa stain of a positive *Chlamydia trachomatis* culture. McCoy cells were infected as described in the legend to Fig. 33-1 with conjunctival scrapings from a 3-day-old infant. After 48 h, the culture was fixed with methanol and stained with Giemsa stain. The infected cells have a distinct intracytoplasmic inclusion, which is dark purple with a halo. These inclusions often appear to be pushing the nucleus to the periphery of the cell. Giemsa stain has also been used successfully to stain direct smears of conjunctival scrapings, especially from young infants, to detect *C. trachomatis*-infected cells.



Figure 33-4 DFA smear collection kit for *Chlamydia trachomatis*. Collection kits for the DFA assay are commercially available. The kit shown contains a cytobrush, a regular Dacron swab and a mini-tip swab for the collection of a urethral specimen, a glass slide, a slide holder, and fixative.

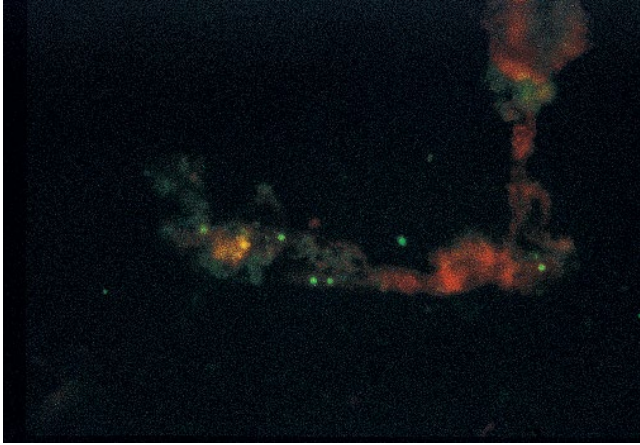


Figure 33-5 Positive DFA test for *Chlamydia trachomatis*. The DFA test was one of the first commercially available tests to aid in the laboratory diagnosis of infections caused by *C. trachomatis*. To perform the DFA test, cell scrapings of the affected area are obtained to optimize the collection of epithelial cells. Smears are prepared, fixed, and stained with a monoclonal antibody to either the lipopolysaccharide (Meridian Bioscience, Cincinnati, OH) or the MOMP (Trinity Biotech Plc, Wicklow, Ireland) of *C. trachomatis*. The smear is examined for apple green-fluorescing EBs or RBs. In the example shown, both the larger RBs and smaller EBs can be seen. The host epithelial cells appear red due to the incorporation of Evans blue dye into the stain. While individual EBs and RBs can be detected, rarely is an intact cell containing an inclusion seen with this test. This test can be performed within 1 h, making it one of the most rapid *Chlamydia* assays.

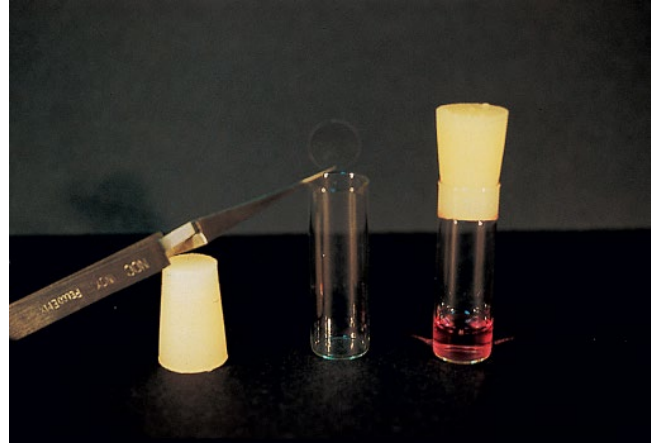


Figure 33-6 Shell vial used for a *Chlamydia* culture. Host cells to be used for a *Chlamydia* culture are grown either on a standard microtiter plate or on a sterile round coverslip that fits in a 1-dram shell vial, as depicted here. The plates or vials can be centrifuged, which is a critical step in optimizing the recovery of *Chlamydia*. Centrifugation should be performed at 35 to 37°C to maximize attachment and infection of the host cells by *Chlamydia*. After an incubation period ranging from 48 to 72 h, the plate or, in the case of the shell vial, the glass coverslip is stained to visualize infected cells. Culture is the recommended method to diagnose a *Chlamydia* infection for medical-legal cases.

Figure 33-7 Rapid immunoassay for the direct detection of *Chlamydia trachomatis*. There are several commercially available antigen-based assays for the direct detection of *C. trachomatis* from genital specimens. None of these tests approaches the sensitivity and specificity of NAATs. The main feature of the antigen assays is that they are rapid and are not technically demanding to perform. In the QuickVue *Chlamydia* test (Quidel, San Diego, CA), a lateral-flow immunoassay, extracted specimens from endocervical swabs are placed on the filter in the bottom portion of the test device, which contains *Chlamydia* murine antibody that has been tagged with colored latex beads. If *Chlamydia* antigen is present in the sample, the antibody-antigen complex migrates up the filter. A red band adjacent to the “T” on the device indicates a positive result due to the trapping of the complex by immobilized antibody on the test device. The control line labeled “C” contains rabbit polyclonal antibody capable of binding the blue control label that also migrates up the test device with the specimen from the bottom well, thus validating that the sample migrated up the device. This image shows a negative (left) and a positive test (right).

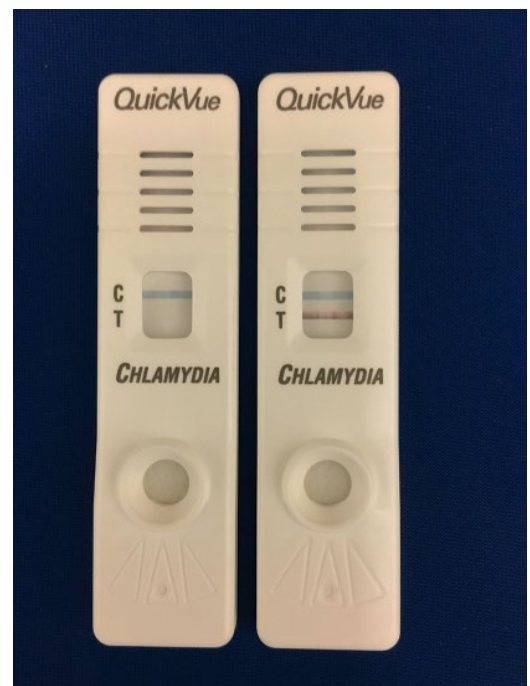




Figure 33-8 Preparation of a slide for the MIF assay. In the MIF assay, purified preparations of EBs are used as antigens to spot microscope slides. Pools of EBs that represent the major serotypes of *C. trachomatis*, *C. pneumoniae*, and *C. psittaci* can be used. A preparation of host cells used to raise the chlamydial antigens serves as a background or nonspecific control. Formalin-treated antigens are mixed with yolk sac and used to spot the slides. As shown, in a single well of a multiwell microscope slide, many antigen-containing dots are applied.

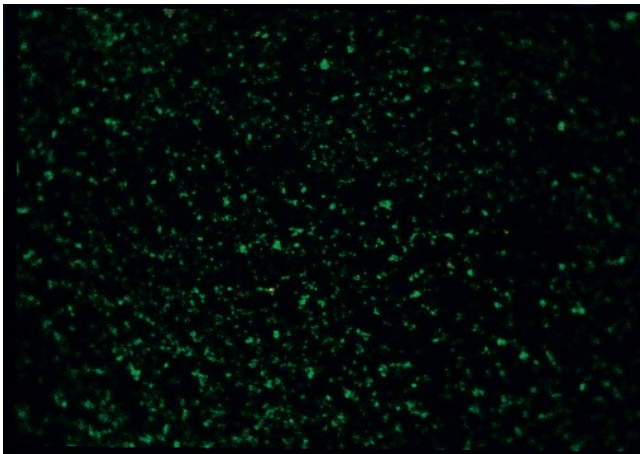


Figure 33-9 Positive MIF assay for *Chlamydia pneumoniae*. Shown here, a single antigen dot (see Fig. 33-8) of *C. pneumoniae* is positive when the EBs are distinct and fluorescent. In this assay, patient serum is serially diluted, applied to wells, incubated, and washed. A secondary antibody to human immunoglobulin tagged with fluorescein isothiocyanate is applied, and the sample is incubated and washed. The slide is then examined under $\times 400$ magnification for the presence of fluorescent EBs. The serum titer to a given antigen is the reciprocal of the highest dilution of serum at which distinct fluorescent individual EBs are seen. Although this method is the gold standard of *Chlamydia* serological testing, it suffers from poor reproducibility due to the inherent variability in the antigen preparation and subjectivity in interpretation.

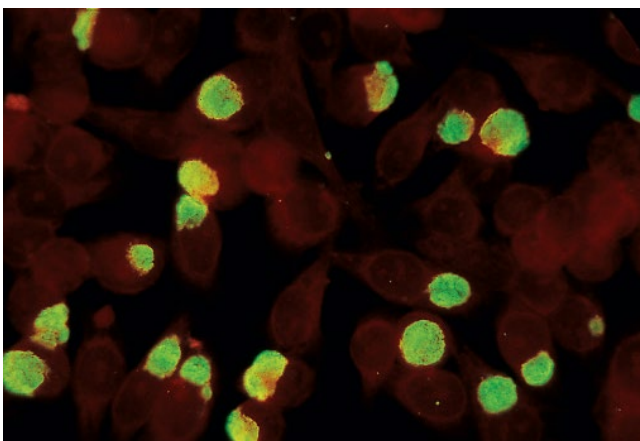


Figure 33-10 Positive inclusion indirect immunofluorescence assay for *Chlamydia trachomatis*. The inclusion indirect immunofluorescence assay is an alternative assay for the serological detection of *Chlamydia* antibodies. In this assay, infected host cells are grown on multiwell slides, fixed, and used to test sera. As described for the MIF (Fig. 33-8 and 33-9), serial dilutions of human sera are tested and the assay results are read microscopically. Here, unlike in the MIF, in which the reader is searching for individual fluorescent EBs, fluorescent intracellular inclusions in the host cell are considered positive. In the example shown, the serum sample is positive for antibodies to *C. trachomatis*.

Mycoplasma and *Ureaplasma*

Mycoplasma and *Ureaplasma* are included in the class *Mollicutes*. More than 16 species are considered human pathogens, but *Mycoplasma pneumoniae*, *Mycoplasma hominis*, *Mycoplasma genitalium*, *Ureaplasma urealyticum*, and *Ureaplasma parvum* are the most common. Mycoplasmas and ureaplasmas are frequently found in the respiratory and urogenital mucosae but can disseminate in the blood, particularly in immunocompromised patients. *M. genitalium* and *Mycoplasma penetrans* are frequently isolated from the genital tract of patients with HIV-1.

M. pneumoniae produces an atypical pneumonia, also called walking pneumonia, that accounts for 10 to 20% of reported pneumonias. These infections are frequently seen in young individuals (5 to 15 years old), older persons, and those living in closed-in groups, such as military personnel. Transmission is thought to be due to aerosol droplets, and most cases occur in the fall and winter. A majority of the infections are asymptomatic; the organism was found in the upper respiratory tracts of 21% of asymptomatic children, but in 5 to 10% of symptomatic individuals. Following an incubation period of 2 to 3 weeks, fever, headache, malaise, and anorexia occur. In these instances, a differential diagnosis from an infection due to *Chlamydia pneumoniae* is usually necessary. An ADP-ribosylating toxin, with DNA sequence homology to the pertussis toxin S1 subunit, known as the community-acquired respiratory distress syndrome toxin, was detected in *M. pneumoniae*. In rare occasions, extrapulmonary manifestations can occur, including meningoencephalitis, ascending paralysis, pericarditis, arthritis, and autoimmune hemolytic anemia due to cold agglutinins.

Isolation of the organism is considered significant, since it does not occur as part of the normal microbiota.

M. hominis and *U. urealyticum* are associated with infections of the urogenital tract. However, both organisms can be isolated from a majority of asymptomatic, sexually active individuals, so their role in disease is still quite controversial. The two organisms originally identified as biovars 1 and 2 of *U. urealyticum* are now classified as two different species, *U. urealyticum* and *U. parvum*. *U. parvum* has not yet been associated with a particular disease in humans. *U. urealyticum* appears to play a significant role in nongonococcal urethritis and female infertility. *M. hominis* has been found in patients with pelvic inflammatory disease and postabortal and postpartum fever. Both organisms can cause neonatal infections, including sepsis, pneumonia, and meningitis. Transmission may be transplacental or can occur at the time of delivery. *M. genitalium* is associated with a significant number of cases of urethritis, cervicitis, endometritis, and pelvic inflammatory disease. Evidence suggests that this organism may be a more important genital pathogen than *U. urealyticum* and may account for 30% of male persistent urethritis. Associations between *M. genitalium* and preterm birth, spontaneous abortion, and HIV-1 infections have been reported.

Mycoplasma fermentans has been recovered from children and adults with respiratory infections. Isolation of *Mycoplasma amphoriforme* from individuals with antibody deficiencies and chronic pulmonary diseases has been described. The roles of these two organisms in the etiology of these diseases are not yet well defined.

Mycoplasmas are the smallest known free-living organisms, with a genome size of less than 600 kb. They lack a cell wall and are surrounded only by a trilayered cell membrane. As a result, they are quite pleomorphic and may have a coccoid shape, measuring 0.2 to 0.3 μm in diameter, or they may have a rod structure that can be up to 2 μm in length. The lack of a cell wall makes mycoplasmas undetectable by Gram staining and insensitive to the activity of β -lactam antimicrobials.

Since mycoplasmas do not have a cell wall, they are very sensitive to environmental conditions. Thus, body fluids, tissue specimens, and swabs should optimally be inoculated at bedside; if that is not possible, they should be transported to the laboratory immediately in media such as 2-SP (containing sucrose, fetal calf serum, and phosphate buffer). The use of a universal transport medium, containing inhibitors to prevent bacterial and fungal growth, for mycoplasmas, ureaplasmas, chlamydiae, and viruses is a good approach that can be implemented in most laboratories. Specimens that cannot be cultured within 24 h of collection should be frozen at -70°C .

These bacteria can grow in artificial media but require nucleic acid precursors and other components that can be supplied by serum. SP4 glucose broth and agar are probably the most appropriate media for culturing *M. pneumoniae* and *M. hominis*, although arginine must be added to isolate the latter organism. Shepard's 10B urea broth (pH 6.0) can be used to isolate *M. hominis* and *U. urealyticum* with the addition of A8 as the solid medium. Biphasic systems using a combination of a broth and agar are also commercially available. The broths should be incubated at 37°C under atmospheric conditions, and the agar plates should be incubated under 5 to 10% CO_2 . Due to the fragility of this organism, broth cultures suspected of containing *U. urealyticum*, which are to be subcultured, should be observed twice daily for the first week to detect a change in color resulting from the hydrolysis of the urea.

Colonies of *M. hominis* measure 50 to 300 μm in diameter and exhibit a "fried egg" appearance resulting from the penetration of the growth in the center of the colony into the agar medium. *M. pneumoniae*, in contrast, produces spherical colonies. *M. hominis* grows rapidly and can form colonies in 1 to 2 days, while *M. pneumoniae* usually is a slow grower, taking 2 to 3 weeks before the colonies can be detected. Guinea pig red blood cells, which adhere to colonies of *M. pneumoniae* but not to those of *M. hominis*, can be useful in distinguishing between the two species. Overall, the recovery of *M. pneumoniae* in culture has very low sensitivity, and therefore, a molecular test is recommended for the detection of this organism in clinical specimens. *U. urealyticum* colonies are smaller, ranging from 15 to 30 μm in diameter, which is the reason *U. urealyticum* is called the T (tiny)-strain mycoplasma. Cultures are usually positive within 24 to 48 h, and the characteristic colony morphology and production of urease are adequate criteria for identification. Colonies growing on agar containing urea and manganese chloride have a dark golden-brown color. Commercial kits for the detection, identification, quantification, and antimicrobial susceptibility testing are now available. Also, molecular techniques for the detection of *Mycoplasma* and *Ureaplasma* and identification of some of these organisms are FDA approved.

Several serological tests are available for the diagnosis of infections due to *M. pneumoniae*. Cold agglutinins have been used for this purpose for many years, but the test lacks sensitivity and specificity. Complement fixation is overall a better method but is technically very demanding. Enzyme immunoassays, indirect immunofluorescence assays, and indirect hemagglutination methods can also be used for the detection of antibodies to this organism. The need for paired acute- and convalescent-phase serum samples tested simultaneously for IgM and IgG to confirm seroconversion limits the utility of these tests. Serological tests have not been proven useful for detection of genital mycoplasma infections.

Figure 34-1 *Mycoplasma hominis* on A7 agar. Colonies of *M. hominis* have a typical “fried egg” appearance as a result of the organisms growing into the agar at the center of the colony and superficially on the periphery. The colonies appear in 1 to 5 days and are 50 to 300 μm in diameter. The typical colony morphology and the arginine positivity of *M. hominis* are usually adequate criteria for identification. Definitive identification can be performed using specific antisera to inhibit the growth of the organism.

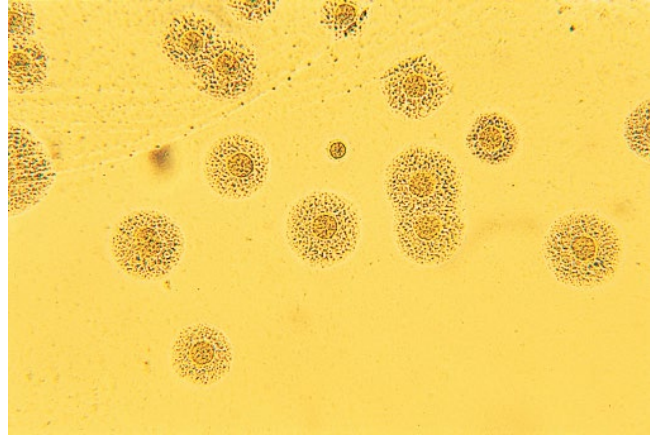
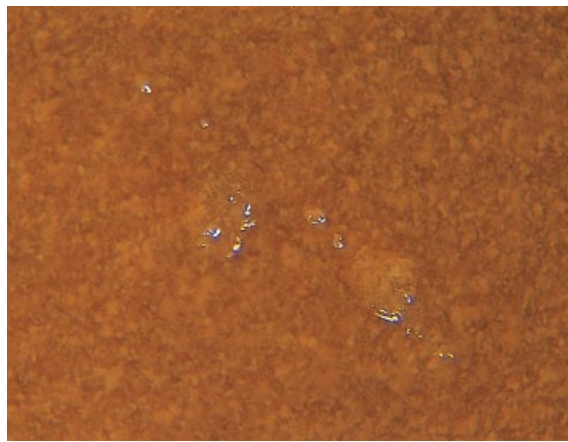
**A****B**

Figure 34-2 *Mycoplasma hominis* on chocolate agar. *M. hominis* is the only pathogenic mycoplasma that grows on bacteriological media such as chocolate and blood agar. Tiny translucent colonies can be observed after 3 to 4 days in culture (A). At higher magnification, the dewdrop appearance of the colony can be better observed (B). These colonies are often overlooked, or the plates are discarded before they become visible.

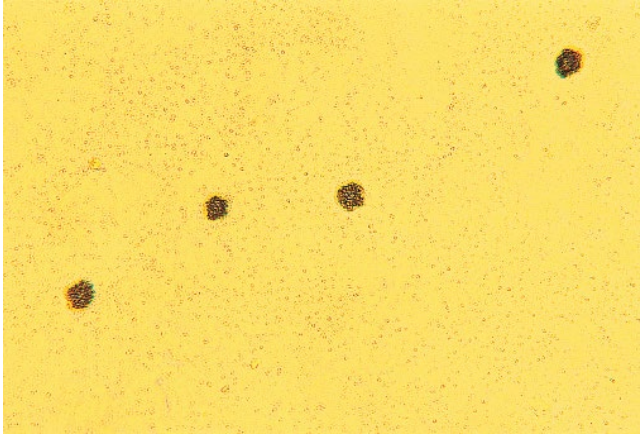


Figure 34-3 *Ureaplasma urealyticum* on A7 agar. *U. urealyticum*, originally called T (for “tiny”) mycoplasma, produces very small colonies ranging in diameter from 15 to 30 μm . On A7 agar, which contains calcium chloride and urea, *U. urealyticum* forms a black precipitate of calcium ammonium chloride at the site of colony formation. Since the colonies are very small, they can be mistaken for several artifacts, including air bubbles, cell debris, and other components of the medium. For that reason, it is important to confirm their identification using the urea test.



Figure 34-4 Urea test for the identification of *Ureaplasma urealyticum*. *U. urealyticum* rapidly hydrolyzes urea, turning the color of the medium from yellow (left tube) to red-purple (right tube) as a result of the change in the pH and the presence of phenol red in the medium as an indicator.



Figure 34-5 Mycotrim GU triphasic culture system. The commercial Mycotrim GU triphasic culture system (Fujifilm Irvine Scientific, Santa Ana, CA), designed for the detection of *M. hominis* and *U. urealyticum* in genitourinary specimens, consists of a diphasic medium containing agar and broth, with phenol red as an indicator. To minimize growth by other microorganisms, disks with nystatin and cefoperazone are added before inoculation of the specimen. The flask is incubated at 34 to 37°C, and the agar is inoculated by allowing the broth to wash over it after 24 h of incubation. The flask should be checked every 24 h for a color change. Growth of *M. hominis* causes the medium to change from yellow (left flask) to orange-red (center flask), while growth of *U. urealyticum* results in a red color (right flask). When the color changes, the colonies on the agar phase can be observed under a microscope. A vial containing Dienes stain is provided to facilitate detection of the colonies. This stain should be used only when the flask is not going to be reincubated, since the organisms are killed.

Leptospira, Borrelia, Treponema, and Brachyspira

35

LEPTOSPIRA

Based on 16S rRNA sequence analyses, spirochetes consist of five clusters: *Treponema*, *Spirochaeta*, *Borrelia*, *Leptospira*, and *Brachyspira* (formerly *Serpula*). In the past, using serological methods, all pathogenic *Leptospira* serovars were included in the species *Leptospira interrogans*, while the nonpathogenic isolates were classified as *Leptospira biflexa*. This nomenclature has now been replaced with a genotypic classification, based on sequencing of the 16S rRNA, in which 23 genospecies include all serovars of *Leptospira*. The following 10 species of *Leptospira* are pathogenic to humans: *Leptospira alexanderi*, *Leptospira alstonii*, *Leptospira borgpeterse-nii*, *Leptospira interrogans*, *Leptospira kirschneri*, *Leptospira kmetyi*, *Leptospira mayottensis*, *Leptospira noguchii*, *Leptospira santarosai*, and *Leptospira weilii*.

Leptospira infection is thought to be the most widespread zoonosis worldwide, accounting for more than a million cases per year, including 100 reported in the United States, particularly in Hawaii. *Leptospira* may be free living or live in association with animals, in particular dogs, rats, and other rodents. Humans are end hosts in the chain of transmission and become infected by direct or indirect exposure to the urine of animals. Occupation is a significant risk factor for humans. The most common source is contaminated water, and as a result, rice and dairy farmers, sewer workers, and swimmers are among the groups most commonly affected. Leptospire infect humans by entering through small breaks in the skin, mucosa, and conjunctiva.

Most infections with *L. interrogans* are asymptomatic, but in certain patients they cause a biphasic illness. During the first week, the leptospire disseminate via the blood. After a short quiescent period of 2 to 4 days, the immune phase begins. During the septicemic phase, patients are frequently asymptomatic or may develop fever, chills, headaches, abdominal pain, myalgias, and conjunctival suffusion. During the immune phase, jaundice, arrhythmias, pulmonary symptoms, aseptic meningitis, photophobia, adenopathy, and hepatosplenomegaly may develop. A fatal disease (Weil's disease) occurs in 5 to 10% of patients as a result of hepatorenal failure.

Members of the genus *Leptospira* are obligately aerobic, thin, tightly coiled rods, with one or both ends of the cell being hooked; the cells measure 0.1 μm in cross section and 6 to 12 μm in length. The name *L. interrogans* is derived from the shape of the organisms, which is in the form of a question mark with a single hook, while the name *L. biflexa* means "twice bent," as these organisms have a hook at both ends. The spirals are right-handed and, in contrast to those of *Treponema* and *Borrelia*, are very close together, resulting in more than 18 coils per organism. Two subterminal periplasmic flagella make these organisms motile. By light microscopy, *Leptospira* is a faintly staining, Gram-negative organism that can be better visualized using carbol fuchsin counterstain.

During the early stages of the disease, blood and cerebrospinal fluid (CSF) are the specimens of choice; later, urine is the preferred specimen. Acute- and

convalescent-phase serum samples should always be collected to determine the presence of specific antibodies. Although the sensitivity is low, direct wet mounts of urine or CSF can be positive by dark-field microscopy, phase-contrast microscopy, or direct fluorescent-antibody staining. Attention should be paid to artifacts, especially in urine, since they can give false-positive results.

Specimens including blood, CSF, and urine can be cultured by using serum-containing semisolid media, such as Fletcher's, Stuart's, Ellinghausen, or PLM-5. Addition of neomycin or 5-fluorouracil to the medium helps to reduce contamination from the normal bacterial microbiota. Once growth is detected, either macroscopically or by dark-field microscopy, the culture can be transferred to a nonselective medium. Several tubes, each containing 5 ml of medium, should initially be inoculated with 1 or 2 drops of blood or with 0.5 ml of CSF. Urine specimens need to be diluted before inoculation in order to minimize the chances of overgrowth by other organisms present in the urine. Tissues should be minced, and small fragments should be plated. Cultures are generally held at 28 to 30°C for up to 4 months. A drop of the culture should be microscopically examined weekly for the first 5 weeks and then every other week. Final identification can be performed using serological techniques and nucleic acid amplification tests. Nucleic acid tests have sensitivity similar to or better than that of culture and have the advantage that they can confirm the diagnosis during the acute phase of the disease. Monoclonal antibodies can be obtained from the WHO/OIE Leptospirosis Reference Center at the Academisch Medisch Centrum (Amsterdam, Netherlands). However, most cases of leptospirosis are diagnosed serologically using the microscopic agglutination test, in which acute- and convalescent-phase sera are tested in parallel against suspensions of the *Leptospira* serovars. Classification of leptospire requires the identification of both the species and serovar of the isolate and can be accomplished by DNA sequencing or matrix-assisted laser desorption ionization-time of flight mass spectrometry (MALDI-TOF MS).

BORRELIA

All species of *Borrelia* are arthropod borne and, with the exception of *Borrelia recurrentis* and *Borrelia duttonii*, which infect only humans, are maintained by cycling from wild animals to the ticks that feed on them. Soft-shelled ticks of the genus *Ornithodoros* are vectors of

relapsing fever, while hard-shelled ticks of the genus *Ixodes* are common vectors of Lyme borreliosis. *B. recurrentis*, in contrast, is transmitted by the body louse *Pediculus humanus humanus*.

The genus *Borrelia* is divided into two groups, with significant overlap of their genetic and phenotypic characteristics: relapsing fever *Borrelia* and Lyme *Borrelia*. Lyme borreliosis is the most common vector-borne disease in the United States and in Europe and is caused by several genetically related species termed *Borrelia burgdorferi sensu lato*. The *B. burgdorferi sensu lato* complex includes 20 genospecies, and the relapsing fever *Borrelia* group also comprises 20 species.

There are two forms of relapsing fever, the epidemic louse-borne disease caused by *B. recurrentis* and the endemic tick-borne form, which can be caused by various *Borrelia* spp. including *Borrelia hermsii*, *Borrelia turicatae*, and *Borrelia parkeri*. The most common is the louse-borne relapsing fever that occurs under conditions of poor hygiene, crowding, and poverty, where organisms are maintained by passage between lice and humans. Tick-borne relapsing fever is transmitted via saliva during the attachment of ticks. Clinically, in both types of relapsing fever, after an incubation period of 2 to 15 days, there is a massive spirochetemia accompanied by high fever, muscle pain, headaches, and weakness. This episode usually ends suddenly after 3 to 7 days, when an immune response is mounted and the spirochetemia disappears. Several days or even weeks later, the disease often recurs with a less severe course. The relapses are caused by variation of the surface antigens of the organism, resulting in temporary avoidance of the immune system.

Borrelia burgdorferi sensu lato, the etiological agent of Lyme disease, has been divided into separate species, some of which are pathogenic in humans. Included in this group are *B. burgdorferi sensu stricto*, *Borrelia bissettiae*, *Borrelia mayonii*, *Borrelia garinii*, *Borrelia afzelii*, *Borrelia valaisiana*, *Borrelia spielmanii*, and *Borrelia bavariensis*. In Asia, *B. garinii* and *B. afzelii* are the most common cause of Lyme borreliosis, while in North America, only *B. burgdorferi sensu stricto*, *B. bissettiae*, and *B. mayonii* have been isolated from humans. As in the case of syphilis, Lyme borreliosis has three clinical stages: early localized, early disseminated, and late. It usually presents with fever, headaches, malaise, fatigue, and weight loss. Approximately 60% of patients develop erythema chronicum migrans, a skin lesion at the site of the *Ixodes* tick bite. The lesion begins as a macule, which expands to form an annular erythema

with partial central clearing. Hematogenous dissemination to distant organs and tissues can occur days to weeks after the infection, and patients present with fever, fatigue, headache, myalgia, and arthralgia. Involvement of the heart, joints, and central nervous system may occur in the late stages of the disease. Arthritis, mainly involving the knees, is the most common long-term manifestation.

Members of the genus *Borrelia* are microaerophilic, Gram-negative, helical bacteria that measure 0.2 to 0.5 μm by 5 to 30 μm . They have 3 to 10 spirals, and their motility is mediated by 7 to 20 endoflagella per terminus.

Direct staining of blood specimens with Giemsa or Wright's stain may be performed to detect *Borrelia*. The *Borrelia* organisms can usually be seen in the blood from patients with relapsing fever but not from those with Lyme disease. The Warthin-Starry silver stain or monoclonal antibodies can be used to stain tissues. Nucleic acid amplification techniques have high sensitivity when used with select specimens, including CSF, skin biopsies, and synovial fluid.

Although spirochetes causing relapsing fever can be cultured from human blood, the yield of positive cultures from blood samples from patients with Lyme disease is low; therefore, skin biopsy specimens, from the periphery of the erythema, are recommended. Cultures of joint fluid are recommended for patients with arthritis. For the relapsing fever *Borrelia* group, the medium of choice is Barbour-Stoenner-Kelly broth, and the culture should be maintained in a microaerophilic environment at 30 to 33°C for 4 to 6 weeks. Periodic monitoring by dark-field microscopy and final identification can be performed using specific monoclonal antibodies or nucleic acid techniques. The Lyme *Borrelia* group organisms can be grown in liquid Barbour-Stoenner-Kelly or modified Kelly-Pettenkofer medium at 30°C to 34°C for 2 to 3 weeks. Whole blood, serum, plasma, and skin biopsy samples are the specimens more frequently tested. Cultures can be periodically monitored with nucleic acid tests and dark-field microscopy.

Due to the low sensitivity of the direct assays, culture techniques, and molecular methods, serological tests are recommended for the diagnosis of Lyme disease. Positive and equivocal serological screening results should be confirmed by immunoblot analysis. The CDC recommends a two-tier testing strategy. Serum samples should be first tested with enzyme immunoassays (EIAs), chemiluminescence immunoassays, or indirect fluorescent-antibody tests followed by immunoblotting.

During the early stages of the disease, immunoblotting should be used to test for IgM, while IgG can be tested at any stage of the disease. The sensitivity of this approach is low during the early stages (30% to 40%), while late in the disease it approaches 100%. The specificity is over 98%. In Europe, the serodiagnosis of Lyme borreliosis is more complex due to the different *B. burgdorferi sensu lato* genospecies causing disease in different geographical regions. Measurement of intrathecal antibodies in cerebrospinal fluid is still under investigation. An infection with *Treponema pallidum* can give a false-positive Lyme disease result. Therefore, a rapid plasma reagin (RPR) test should also be performed. IgM antibody to *B. burgdorferi* can be detected 2 weeks after infection, and its level usually peaks by the second month; however, IgG may not be detectable for the first 3 to 6 months. IgM and IgG antibodies may persist for up to 20 years after infection. Antigenic variability and the stage of the disease may also affect the serological results.

TREPONEMA AND BRACHYSPIRA

Four species/subspecies of *Treponema* are pathogenic for humans: *Treponema pallidum* subsp. *pallidum* (venereal syphilis), *Treponema pallidum* subsp. *endemicum* (endemic syphilis, also called bejel), *Treponema pallidum* subsp. *pertenue* (yaws), and *Treponema carateum* (pinta). The pathogenic treponemes are exclusively obligately human parasites, and there is no known animal reservoir. In addition, at least six nonpathogenic *Treponema* species are considered part of the normal microbiota. *Treponema denticola* is the prototype of oral treponeme, and its presence has been linked with periodontal disease. *Brachyspira aalborgi*, *Brachyspira pilosicoli*, and *Brachyspira hominis* have been associated with human intestinal spirochetosis.

Syphilis, the most common disease caused by treponemes, is usually transmitted by sexual contact with individuals who have an active primary or secondary lesion. In addition, congenital syphilis occurs as a result of transplacental transmission. It is estimated that the prevalence of syphilis worldwide is approximately 1%.

Three stages occur during the natural course of syphilis. The primary lesion develops in the first 3 months after exposure, as a result of the inflammatory response to the infection at the site of inoculation. The lesion starts as a papule and then becomes an ulcer, or chancre, that is firm, single or multiple, painless, and not tender, with a clean surface and a raised border, that can measure up to 1 to 2 cm in diameter and is

accompanied by local lymphadenopathy. The chancre usually heals; however, as a result of the rapid dissemination of *T. pallidum* via the bloodstream, the secondary stage may appear 6 weeks to 6 months postinfection. The secondary stage can present with a rash on the mucosa and skin, typically including the palms and soles; fever; sore throat; headache; generalized lymphadenopathy; and sometimes involvement of the central nervous system. Alternatively, it may be asymptomatic or mild. During this stage, which lasts several weeks, patients are still highly contagious. In approximately 30% of cases, the disease does not progress, and in another 30%, the infection becomes latent and does not produce clinical symptoms, but in the remaining 30 to 50%, the tertiary stage develops 2 to 20 years later. CDC has recommended changing the terms “early latent syphilis” and “late latent syphilis” to “early nonprimary nonsecondary syphilis” and “unknown duration or late syphilis,” respectively. During the tertiary stage, the heart and the central nervous system can be involved. Granulomatous lesions, called gummas, may appear, involving among other organs the skin, bones, and liver. In general, patients are not infectious during this stage.

Congenital syphilis results when treponemes cross the placenta and infect the fetus. When the mother becomes infected during pregnancy, acute infection of the fetus and stillbirth can occur. Babies born with congenital syphilis may have a multitude of malformations, including interstitial keratitis, deafness, neurosyphilis, and bone and tooth deformities.

The other three diseases produced by human treponemes, bejel, yaws, and pinta, are nonvenereal infections. Bejel, or endemic syphilis, is found in the hot and arid regions of the world. The primary lesions are usually not detected. During the secondary stage, papules are formed that can progress to gummas involving the skin, bones, and oropharynx. Yaws is found in the tropical, humid areas of the world and resembles syphilis. The primary lesion, however, is elevated and granulomatous, and late, destructive lesions of the skin, bones, and lymph nodes occur. Pinta is found in the tropical areas of Central and South America and causes skin lesions, mainly papules that can result in scarring, accompanied by regional lymphadenopathy.

T. pallidum is 0.1 to 0.2 μm thick and 6 to 20 μm long and is spiral with 6 to 14 helices per cell. The ends of the organism are pointed and lack the hook shape of the nonpathogenic treponemes. Flagella at both ends give the organism its typical corkscrew motility.

Treponemes cannot readily be cultured, and so alternative methods are used for the diagnosis of syphilis. The gold standard is the rabbit infectivity test; however, this method is used only in research laboratories. During the primary and secondary stages and during early congenital syphilis, direct observation of motile treponemes from the base of the chancre or from the skin or mucosal lesion by dark-field microscopy or the direct fluorescent-antibody *T. pallidum* test is considered diagnostic. It is important, however, when using dark-field microscopy, particularly with oral lesions, to remember that nonpathogenic treponemes are part of the normal microbiota. Immunohistochemistry methods with specific antibodies are recommended for staining the organism in tissues.

For screening, a nontreponemal test is used for detection of serum antibodies. If the test shows a reaction, it is confirmed by performing a treponemal test. Serological tests may be negative until 1 to 4 weeks after the chancre has formed, but they have nearly 100% sensitivity during the secondary stages. However, during the late stage of the disease, the sensitivity of the nontreponemal tests is low.

The nontreponemal tests detect antibodies to lipid components released from the treponemes and from the host cells. The antigen used for these tests is an alcoholic solution containing cardiolipin, cholesterol, and lecithin. The rapid plasma reagin (RPR) test and the Venereal Disease Research Laboratory (VDRL) test are the two most widely used nontreponemal tests. These tests are excellent screening methods, but they have to be confirmed by a treponemal test, since they detect nonspecific antibodies.

Serological treponemal tests use treponemes grown in rabbit testicles to detect antibodies. These tests are used to confirm positive nontreponemal tests and are also helpful for detecting antibodies during the late stage of the disease. Furthermore, these tests remain positive in treated patients after the nontreponemal tests become negative. To perform these tests, the patient's serum is first adsorbed with *Treponema phagedenis* biotype Reiter, to remove antibodies to nonpathogenic treponemes. The fluorescent treponemal antibody adsorption double-staining (FTA-ABS DS) test and the *T. pallidum* particle agglutination (TP-PA) test are the two most commonly used treponemal tests. The FTA-ABS DS test is an indirect fluorescent-antibody test that uses *T. pallidum*, fixed on a slide, as the antigen. After incubation with human serum, a tetramethylrhodamine isothiocyanate-labeled anti-human Ig antibody is added, and the specimen is observed under a fluorescence

microscope. A fluorescein isothiocyanate-labeled anti-*T. pallidum* conjugate is also added to demonstrate the presence of the organisms on the slide. The TP-PA test is a passive agglutination test that uses gelatin particles sensitized with *T. pallidum*. Specific antibodies react with the sensitized particles and form a smooth mat. EIAs are also commercially available for the serological diagnosis of syphilis.

In reverse sequence syphilis screening, the serum samples are first tested using a treponemal enzyme-linked immunosorbent assay (ELISA). These ELISAs use recombinant antigens (in particular the 15-, 17-, 44.5-, and 47-kDa proteins) that induce long-term antibody responses and are thought to be specific for pathogenic treponemes. Individuals with a negative treponemal ELISA should be considered not infected with *T. pallidum*, unless an early primary infection is suspected. In persons with suspected early primary infection and a negative ELISA, a new sample should be tested in 2 to 4 weeks. Samples from patients with a positive ELISA should then be tested with the RPR test. Samples with a positive RPR test should be titrated to determine the level of anticardiolipin antibodies, a result that subsequently can be used to assess the response to therapy. For these patients, treatment is indicated unless the patient was previously treated.

Patients with a positive treponemal ELISA and a negative RPR test should be tested with another type of treponemal assay. If the treponemal test is nonreactive, the most likely explanation is that the treponemal screening ELISA was a false positive. A new specimen can be tested in 2 to 4 weeks to confirm the interpretation. If the second treponemal test is also positive, the patient most likely has been treated in the past for syphilis. However, treatment is indicated unless a history of syphilis exists. When the clinical assessment of a

patient does not match the laboratory results, a new sample should be tested in 2 to 4 weeks. Rapid qualitative nontreponemal, or treponemal antibody, tests are not available.

Brachyspira spp. are oxygen-tolerant anaerobes that can be found in humans, dogs, pigs, and birds. *Brachyspira* spp. were isolated from patients with intestinal spirochetosis and are comma-shaped or helical, 2 to 6 μm long and 0.2 μm wide, with tapered ends containing flagella that produce a typical corkscrew motility.

Brachyspira spp. stain poorly with Gram stain, and they are best visualized by the Warthin-Starry silver stain. They are mainly identified using nucleic acid amplification techniques, MALDI-TOF MS, or fluorescent *in situ* hybridization in colon biopsy samples, since they require several weeks of incubation under anaerobic conditions for growth in culture. Infection/colonization with *Brachyspira* spp. produces a noninflammatory lesion in the colon. Adults are usually asymptomatic, while children, men that have sex with men, and patients with an HIV-1 infection may have pain and diarrhea. The spirochetes attach end-on to the epithelium, forming a dense, palisade-like basophilic structure looking like a false brush border that can be visualized with hematoxylin-eosin, periodic acid Schiff, or silver stain. Specimens with *Brachyspira* spp. should be cultured anaerobically at 37°C to 42°C in brain heart infusion agar or Trypticase soy agar medium supplemented with 5% to 10% defibrinated ovine or bovine blood with antibiotics (spectinomycin, colistin, and vancomycin) for 1 to 2 weeks. The colonies are 1 to 1.5 mm in diameter, light gray and weakly beta-hemolytic. In cases of spirochetemia, which usually happens in severely immunocompromised patients, *Brachyspira* spp. can grow in some blood culture systems with an incubation period of 10 to 15 days.

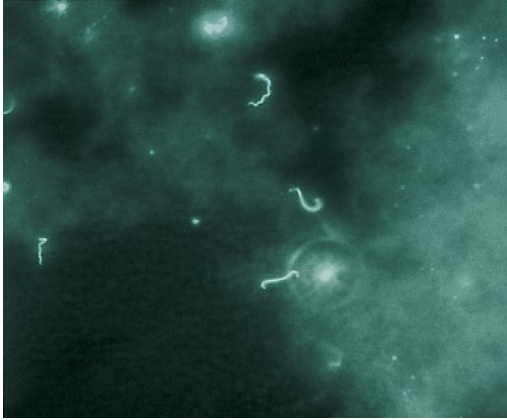


Figure 35-1 Dark-field micrograph of *Leptospira interrogans*. Members of this genus have tight coils and hooked ends. As the organisms die, they lose these coils and hooked ends. (Courtesy of Orange County Health Department, Santa Ana, CA.)

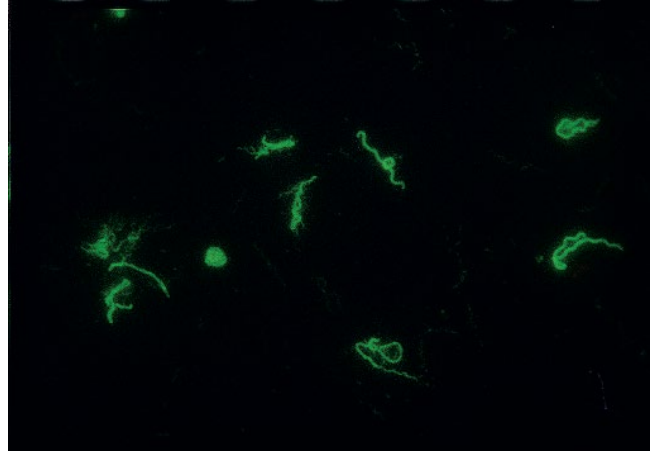


Figure 35-2 Fluorescent staining of *Leptospira interrogans*. As shown here, *L. interrogans* has tight coils. In one of these organisms, the hooked ends can be observed.

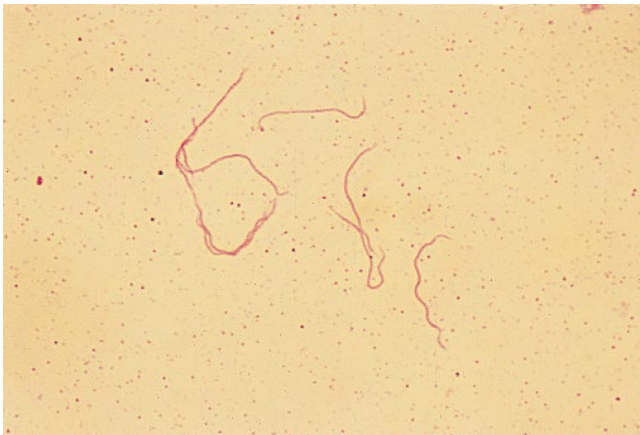


Figure 35-3 Gram stain of *Borrelia burgdorferi* counterstained with carbol fuchsin. *B. burgdorferi* is a coiled, Gram-negative bacillus that measures 0.2 to 0.5 μm by 5 to 30 μm .

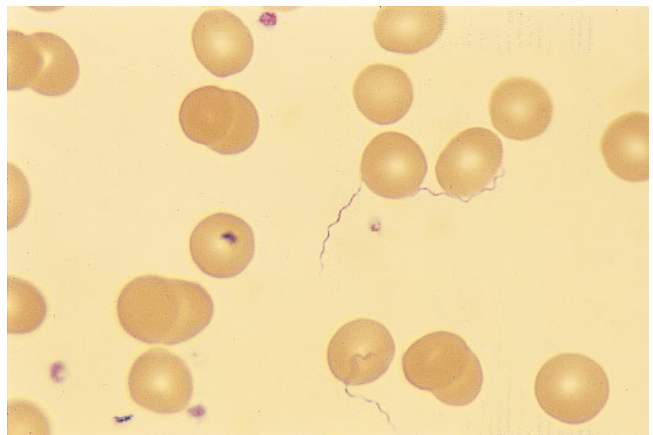


Figure 35-4 Wright-stained peripheral blood smear containing *Borrelia hermsii*. The preparation shown here was made by mixing a pure culture of *B. hermsii* and peripheral blood collected in a tube with heparin. Note the thin structure and loose coils of these organisms.

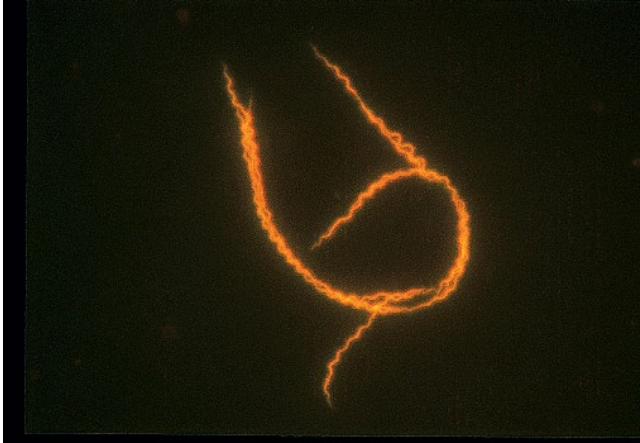


Figure 35-5 Peripheral blood stained with acridine orange for *Borrelia hermsii*. Acridine orange staining of blood specimens can greatly facilitate the detection of *Borrelia* organisms. The preparation shown here was made by mixing a pure culture of *B. hermsii* with heparinized peripheral blood.



Figure 35-6 Female (left) and male (right) *Ixodes pacificus* ticks. *I. pacificus* is the arthropod vector of *B. burgdorferi* in the western United States. These hard ticks transmit the infection to humans after biting infected rodents. As shown here, the hard ticks are differentiated from the soft ticks by the presence of the scutum, a chitinous plate on the anterior portion of the dorsal surface of these parasites. (Specimens courtesy of Alan G. Barbour, University of California, Irvine, CA.)

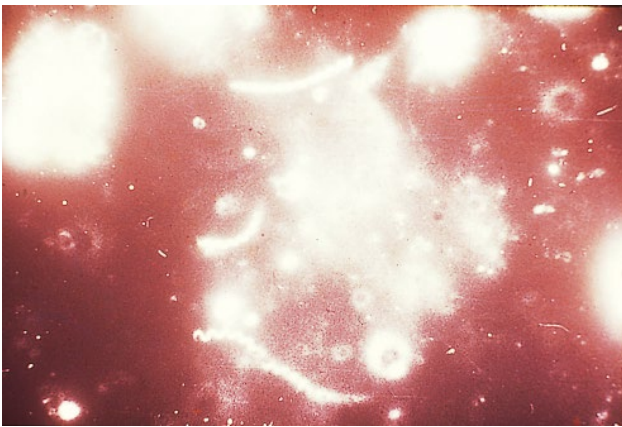


Figure 35-7 Dark-field micrograph of *Treponema pallidum* subsp. *pallidum*. Dark-field microscopic examination of a sample collected from a chancre reveals *T. pallidum*, which appears as an elongated helical corkscrew. Observations of fresh specimens should show the motility of *T. pallidum*. In this case, the motility has resulted in a blurry image. (Courtesy of J. Miller, University of California, Los Angeles, CA.)

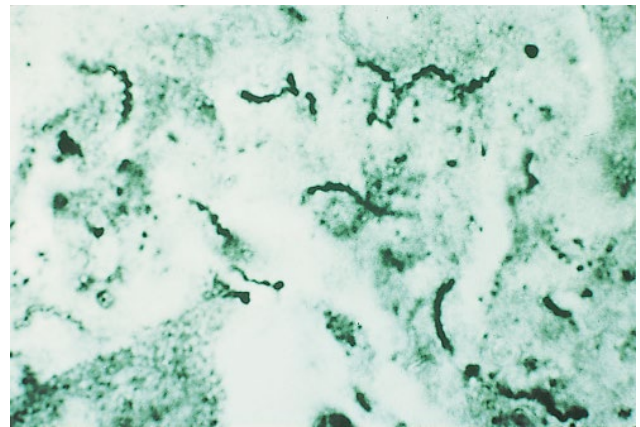
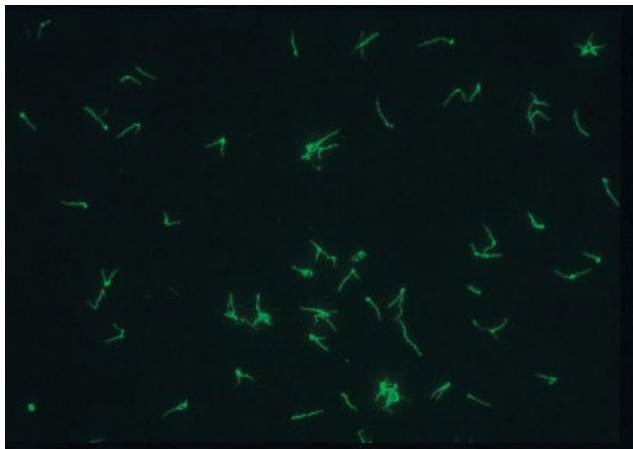


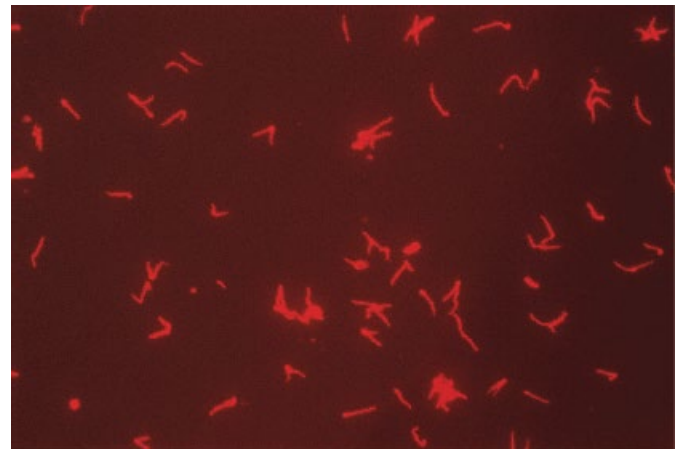
Figure 35-8 Silver stain preparation from the liver of a patient with congenital syphilis. This Warthin-Starry stain of the liver from a patient with congenital syphilis shows *T. pallidum* with its typical tight-spiral coils. (Courtesy of J. Miller, University of California, Los Angeles, CA.)



Figure 35-9 RPR card test. The RPR test is a nontreponemal test that uses the flocculation of lipoidal particles to indicate reactivity. Carbon particles, bound to the cardiolipin, make the reaction visible to the naked eye. Here, the well on the left shows a negative reaction and the well on the right shows a positive reaction. The RPR test can be used to provide qualitative and quantitative results.



A



B

Figure 35-10 FTA-ABS DS test. *T. pallidum* subsp. *pallidum* Nichols is used as the antigen for the FTA-ABS DS test. After adsorption of the patient's serum with the nonpathogenic *Treponema phagedenis* Reiter treponeme, the specimen is incubated with the antigen. (A) The fluorescein isothiocyanate-labeled anti-*T. pallidum* conjugate counterstain is used to locate the treponemes when there are no antibodies in the specimen. (B) Rhodamine-labeled anti-human Ig is then added, and in individuals with specific antibodies, the spirochetes are orange when observed by fluorescence microscopy.

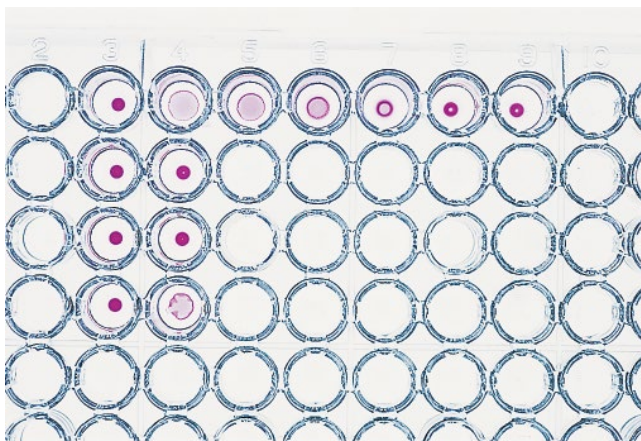


Figure 35-11 *Treponema pallidum* particle agglutination test. *T. pallidum* adsorbed to gelatin particles is used as the antigen for the Serodia TP-PA test (Fujirebio Diagnostics, Inc., Malvern, PA). The top row shows the titration of the reactive control and the patient samples in the other wells. Unsensitized gelatin particles are included as a control for nonspecific reactivity (left column). A well with particles forming a large ring with a rough, multiform outer margin and peripheral agglutination surrounded by a small circle is given a score of 1+. A smooth mat of agglutinated gelatin particles covering the bottom of the well is given a score of 4+. This method is easy to perform and interpret in comparison with the FTA-ABS DS test and does not require expensive equipment. Overall, it is considered slightly less sensitive but a little more specific than the FTA-ABS DS test.

Figure 35-12 Trep-Sure EIA. The Trep-Sure Syphilis Total Antibody EIA (Trinity Biotech, Bray, Ireland) is a qualitative polyvalent sandwich assay that uses specific recombinant treponemal antigens immobilized on the microplate wells. Patient samples and controls are added and washed, and the antigen-antibody complexes are subsequently reacted with horse-radish peroxidase-conjugated treponemal antigens. After a second wash, 3,3',5,5'-tetramethylbenzidine, as a substrate for the peroxidase, is added. The resulting yellow to yellow-brown color is measured spectrophotometrically (450 nm), and the stop solution is added. Color intensity is proportional to the amount of antibody present in the patient's sample.

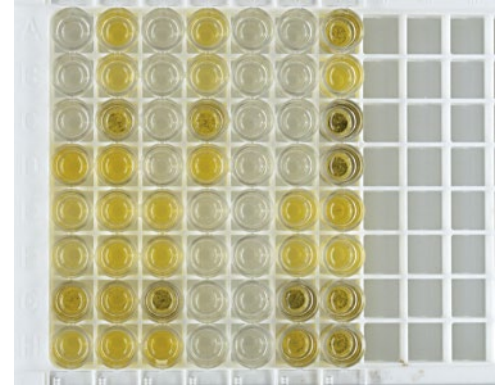


Figure 35-13 INNO-LIA Syphilis Score. The INNO-LIA Syphilis Score (Fujirebio) assay is a line immunoassay that uses three recombinant antigens (TpN47, TpN17, and TpN15) and one synthetic peptide (TnpA) from *T. pallidum* (Nichols strain) to detect antitreponemal IgG antibodies in patients' sera. In addition to the syphilis antigens, four control lines are included for a semiquantitative assessment of the results and to verify the correct addition of the reagents and sample. This assay is being evaluated as a confirmatory test for the serological diagnosis of syphilis.

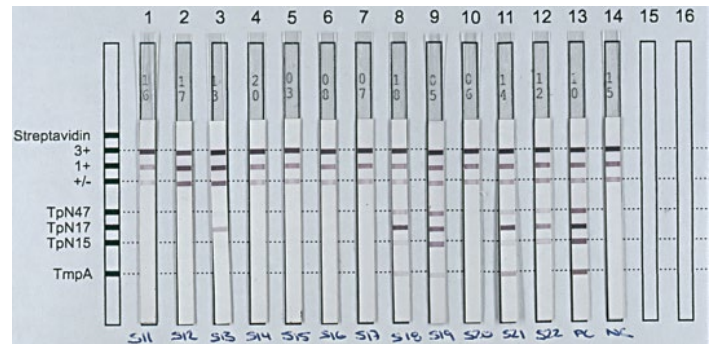
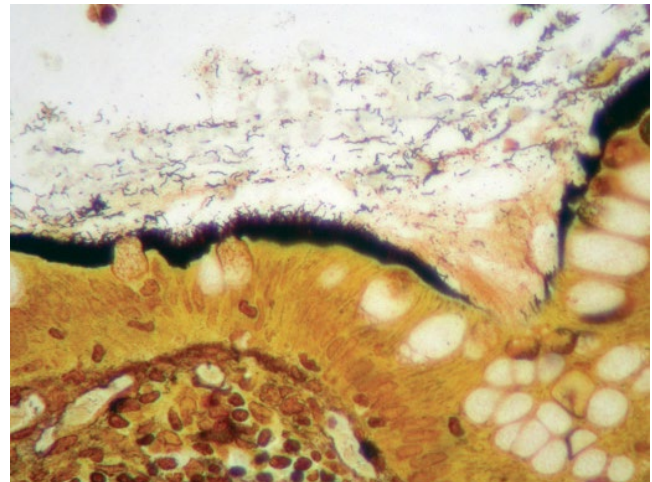


Figure 35-14 *Brachyspira* Warthin-Starry silver stain. *Brachyspira* spp. attach end-on to the epithelium of the large intestine and form a palisade. Here, the organism can be seen as a brown-black brush at the edge of the intestinal epithelium. *Brachyspira* spirochetes are also observed in the lumen of the colon. (Courtesy of Dominick Cavuoti, University of Texas Southwestern Medical Center, Dallas, TX.)



Rickettsia, *Orientia*, *Ehrlichia*, *Anaplasma*, and *Coxiella*

36

RICKETTSIA AND ORIENTIA

The family *Rickettsiaceae* comprises two genera, *Rickettsia* and *Orientia*. More than 20 species of *Rickettsia* have been described, while *Orientia tsutsugamushi* and *Orientia chuto* are the two species in the genus *Orientia*. These bacteria are small, measuring approximately 0.3 to 0.5 μm by 1 to 2 μm , and grow in the cytoplasm of eukaryotic cells; they were therefore originally considered to be viruses. Animals are their reservoir, and humans are only accidental hosts as a result of transmission by arthropod vectors.

Several species of *Rickettsia* can cause infections in humans. Table 36-1 lists some of the most important epidemiological characteristics of the organisms that cause human infections. Two main groups of human infections are recognized: spotted fever and typhus. In the United States, the most common pathogen is *Rickettsia rickettsii*, the agent of Rocky Mountain spotted fever (RMSF), which causes approximately 500 documented cases annually. The ticks *Dermacentor andersoni* and *Dermacentor variabilis* are the most common reservoirs and vectors for this disease. In the United States, most of these infections occur from April through October. Following approximately 1 week of incubation, a person bitten by a tick harboring *R. rickettsii* can develop fever, chills, headache, abdominal pain, vomiting, myalgias, and a rash. The rash usually starts in the extremities, involving the palms and soles, and spreads to the trunk. Rickettsiae infect endothelial cells that increase vascular permeability and may produce focal hemorrhages. In certain cases, serious complications occur,

including respiratory and renal failure, gastrointestinal symptoms, and encephalitis.

Rickettsia prowazekii causes epidemic typhus (louse-borne typhus) and is transmitted throughout the world by the human body louse, *Pediculus humanus humanus*. The spread of this infection occurs in situations where people live under crowded, unsanitary conditions, such as during famines and wars. In the United States, this infection is more commonly found in the eastern states, where squirrels are infected. The initial symptoms are similar to those described for RMSF, but the rash occurs in only 30 to 40% of the patients. The mortality is as high as 60 to 70% in patients who develop myocarditis or central nervous system involvement. A recurrent form, called Brill-Zinsser disease, can occur years after the initial infection and usually has a mild clinical presentation.

Rickettsia typhi is the etiological agent of endemic or murine typhus, which has a worldwide distribution. Fewer than 50 cases are reported in the United States on an annual basis, but this disease is endemic in temperate and subtropical areas of the world. The main vector is the rat flea, *Xenopsylla cheopis*, and rodents are the primary reservoirs. After 1 to 2 weeks of incubation, the clinical presentation is similar to that described for *R. rickettsii*, although in most patients the rash is restricted to the chest and abdomen. Even in untreated patients, the disease resolves within 3 to 4 weeks.

Rickettsia parkeri causes a relatively mild disease with an eschar at the site of tick inoculation, myalgia, fever, headache, rash, and, rarely, regional lymphadenitis.

Table 36-1 Epidemiology of common *Rickettsia* and *Orientia* infections

Organism	Disease	Vector	Reservoir	Distribution
<i>R. rickettsii</i>	Rocky Mountain spotted fever	Ticks	Ticks, rodents	Western Hemisphere
<i>R. africae</i>	African tick bite fever	Ticks	Ticks	Africa, Caribbean
<i>R. australis</i>	Queensland tick typhus	Ticks	Ticks	Australia
<i>R. akari</i>	Rickettsialpox	Mites	Mites, rodents	United States, Russia, Korea, Mexico, Turkey
<i>R. conorii</i>	Mediterranean spotted fever (boutonneuse fever)	Ticks	Ticks	Mediterranean countries, Asia, Africa
<i>R. felis</i>	Flea-borne spotted fever	Unknown	Cats	America, Africa, Europe
<i>R. heilongjiangensis</i>	Far Eastern tick-borne rickettsiosis	Ticks	Russia	
<i>R. honei</i>	Flinders Island spotted fever	Ticks	Ticks	Australia, Thailand
<i>R. japonica</i>	Japanese spotted fever	Ticks	Ticks	Japan, Korea
<i>R. parkeri</i>	American tick bite fever	Ticks	Ticks	North and South America
<i>R. prowazekii</i>	Epidemic typhus	Lice	Humans, rodents	Worldwide
<i>R. sibirica</i>	North Asian tick typhus, lymphangitis-associated rickettsiosis	Ticks	Ticks	Africa, Asia, Europe
<i>R. slovaca</i>	Tick-borne lymphadenopathy	Tick	Unknown	Eurasia
<i>R. typhi</i>	Murine typhus	Fleas	Rodents	Worldwide
<i>O. tsutsugamushi</i>	Scrub typhus	Mites	Mites, rodents	Asia, Australia

Rickettsia felis infection has the geographical distribution of the cat flea, and its clinical manifestations are not well defined.

Scrub typhus is caused by *Orientia* (formerly *Rickettsia*) *tsutsugamushi*. Mites act as reservoirs and vectors of this infection. The disease is endemic in the “tsutsugamushi triangle,” which extends from Japan to Pakistan, Afghanistan, and Australia, resulting in 1 million cases per year. Infections in the United States are usually imported. Following 1 to 2 weeks of incubation, fever, headache, and myalgias appear, and approximately 50% of patients develop a rash that starts on the trunk and spreads to the extremities. Involvement of the reticuloendothelial system, with cardiovascular and central nervous system complications, can occur. If the disease is untreated, 30% of those infected can die. Only one human case of *Orientia chuto* infection has been described.

For the diagnosis of rickettsial diseases, heparinized blood should be collected early in the course of the infection for isolation and serological testing. Samples for culture should be sent to the laboratory as soon as possible or stored at -70°C . *R. prowazekii*, *R. rickettsii*, *R. typhi*, and *R. conorii* are bioterrorism threats, via aerosol exposure to organisms that are infectious at a low dose, and therefore isolation of *Rickettsia* needs to be performed in a biosafety level 3 laboratory. A punch biopsy specimen from a skin lesion can also be used for immunohistochemistry, culture, or molecular analysis. Nucleic acid amplification tests (NAAT) are the most sensitive method for detection, particularly from eschars.

Rickettsia can also be isolated in tissue culture or embryonated eggs. Tissue cultures using cell lines such as Vero, L-929, or MRC5 are grown in shell vials, and the sample is inoculated by centrifugation. The monolayers are then stained after 48 to 72 h of incubation at 34°C in 5% CO_2 . The organisms stain faintly with the Gram stain but can be better observed with Giemsa or Gimenez stain or with fluorescent antibodies. Monoclonal antibodies or NAAT are now used for the identification of clinical isolates.

The Weil-Felix test, which employs *Proteus* antigens, was used for many years as a serological test for the presumptive diagnosis of rickettsial diseases. The indirect immunofluorescence assay is the current gold standard serological method. Commercially prepared antigens are now available for differentiating the spotted fever group from the typhus group. Latex agglutination, enzyme immunoassays, and Western blot analyses are also available for serological diagnosis. Optimally, acute- and convalescent-phase samples should be tested. A 4-fold increase in antibody titer, or seroconversion, is diagnostic.

EHRlichia, ANAPLASMA, NEORICKETTSIA, AND WOLBACHIA

In the order *Rickettsiales*, family *Anaplasmataceae*, there are five genera: *Ehrlichia* (*Ehrlichia ewingii* and *Ehrlichia chaffeensis*), *Anaplasma* (*Anaplasma phagocytophilum*, formerly *Ehrlichia phagocytophila*),

Table 36-2 *Anaplasma*, *Ehrlichia*, and *Neorickettsia* species known to produce infections in humans

Organism	Disease	Vector	Reservoir	Distribution
<i>A. phagocytophilum</i>	Human granulocytic anaplasmosis	<i>I. persulcatus</i> group	Deer, sheep, white-footed mice	America, Europe, Asia
<i>E. chaffeensis</i>	Human monocytic ehrlichiosis	<i>A. americanum</i> , <i>D. variabilis</i>	White-tailed deer, dogs	Worldwide
<i>E. ewingii</i>	Ewingii ehrlichiosis, canine granulocytic ehrlichiosis	<i>A. americanum</i> , <i>D. variabilis</i>	Canids, white-tailed deer	Worldwide
<i>N. sennetsu</i>	Sennetsu fever	Unknown; acquired by ingestion?	Fluke-infested fish	Asia

“*Candidatus* Neoehrlichia,” *Neorickettsia* (*Neorickettsia sennetsu*), and *Wolbachia* species (Table 36-2). The first three are transmitted by ticks, while *N. sennetsu* is thought to be acquired by eating infested fish. *Wolbachia* is not a human pathogen. These bacteria are Gram-negative, obligately intracellular organisms that replicate within host membrane-derived cytoplasmic vacuoles, called morulae. The host cell eventually ruptures, and other cells become infected. The host cells most frequently infected are hematopoietic in origin. *Ehrlichia*, *Anaplasma*, and *Neorickettsia* species produce two morphological forms. A small compact dense form, measuring 0.2 to 0.4 μm , and a larger reticulate body (*Anaplasma* and *Ehrlichia*), or lighter form (*Neorickettsia*), that measures 0.8 to 1.5 μm .

Ehrlichia spp. are zoonotic agents that are transmitted to humans following a tick bite. The most common causative organisms are *E. chaffeensis*, which causes human monocytic ehrlichiosis, *E. ewingii*, the etiological agent of human ewingii ehrlichiosis, and *Ehrlichia muris* subsp. *eaucloirensis*, which produces murine monocytic ehrlichiosis. Other species causing infections in humans include Panola Mountain *Ehrlichia* species and *Ehrlichia canis*. *E. chaffeensis* is distributed mainly in the southern regions of the United States corresponding to the location of the lone star tick (*Amblyomma americanum*), the primary vector for this organism that feeds on several hosts, mainly white-tailed deer and domestic dogs. This tick also transmits *E. ewingii*, while *E. muris* subsp. *eaucloirensis* is transmitted by *Ixodes scapularis*, which feeds on white-footed mice. Approximately 1,000 cases of infection with *E. chaffeensis* and 10 cases of infection with *E. ewingii* and *E. muris* subsp. *eaucloirensis* are reported to the CDC each year. Most of these infections occur in the summer. *E. muris* subsp. *eaucloirensis* has been reported only in Minnesota and Wisconsin. Rarely, these infections are transmitted by organ transplantation or blood transfusion. Diagnosing these infections is

difficult, because there is significant cross-serological reactivity, but nucleic acid methods can provide definitive answers.

N. sennetsu (Sennetsu fever) is found in Japan and other parts of Asia and is acquired as a result of the ingestion of raw fish infested with flukes that contain this organism. Around 100 cases are reported per year. Patients with Sennetsu fever present with clinical manifestations similar to those of infectious mononucleosis, including fever, chills, headache, malaise, sore throat, anorexia, and generalized lymphadenopathy. Atypical lymphocytes in peripheral blood may be observed.

Neoehrlichiosis is an emerging tick-borne human infection affecting mainly immunocompromised patients in Asia and Europe and is caused by “*Candidatus* Neoehrlichia mikurensis,” which is found in *Ixodes persulcatus* and other ticks.

A. phagocytophilum, the etiological agent of human granulocytic anaplasmosis (HGA), previously called human granulocytic ehrlichiosis, is for the most part found in the United States, although cases have also been reported in Europe and Canada. *Ixodes persulcatus* complex, including *Ixodes scapularis* (black-legged tick) in the United States and *Ixodes pacificus* (western black-legged tick) and *Ixodes ricinus* (castor bean tick) in Europe are the vectors. *Ixodes persulcatus* (taiga tick) is thought to be the vector in Asia. These ticks are also the vectors for *Borrelia burgdorferi sensu lato* complex, the etiological agent of Lyme borreliosis, and therefore, patients can be infected with both pathogens. White-footed mice, chipmunks, voles, and other wild rodents are the primary reservoir. HGA, after spotted fever rickettsiosis, is the most common rickettsial disease in the United States, with approximately 2,000 cases reported per year. Most symptomatic cases of HGA occur in the spring and summer, the peak time of nymph host-seeking behavior, but a smaller peak

occurs in October, when adult ticks are host seeking. There are occasional reports of transmission via blood products and transplacentally. Other *Anaplasma* species that have been found in humans are *Anaplasma capra* and *Anaplasma ovis*.

Clinical presentations of *E. chaffeensis* range from asymptomatic to life-threatening diseases. Following an incubation period of 1 to 2 weeks, the patient presents with fever, malaise, headache, myalgia, and nausea. Petechiae and macular and maculopapular rashes are common in children and less frequent in adults. Gastrointestinal, osteoarticular, and central nervous symptoms can occur. Increases in liver enzyme levels, thrombocytopenia, and leukopenia with lymphopenia and/or neutropenia are common findings. Immunocompromised patients with HIV-1 infection, on corticosteroids, on immunosuppressive agents, or with diabetes are at higher risk of severe complications. The clinical presentations of *E. ewingii* and *E. muris* subsp. *eauclairensis* are similar to those of *E. chaffeensis*.

The clinical manifestations of HGA parallel those observed in patients with RMSF. However, a rash occurs in fewer than 10% of the patients, while leukopenia and thrombocytopenia are frequently observed.

These infections can be diagnosed by collecting blood in EDTA, or cerebrospinal fluid, and performing culture, histological analysis, NAAT, or serological detection of specific antibodies. Peripheral blood, or buffy coats, stained with Giemsa or Wright stain to detect the presence of intracellular morulae within granulocytes is valuable for HGA, but it has less sensitivity for *E. chaffeensis* ehrlichiosis. Morulae are observed in 50 to 80% of cases of HGA. For direct detection, NAAT should be performed on whole blood or buffy coats that contain infected leukocytes. Several tissue culture cell lines, including DH82, THP-1, HEL-22, HL-60, and Vero cells, can be used for isolation. Culture requirements vary from a few days to a month, and the presence of the organisms is usually confirmed by NAAT. An indirect fluorescent-antibody assay involving *Ehrlichia/Anaplasma*-infected cells on a glass slide or an immunoblot analysis can be used for serological testing. Testing of acute- and convalescent-phase sera can provide a definitive diagnosis by showing a 4-fold rise in IgG titer or seroconversion. However, there is a significant amount of cross-reactivity among some of these organisms. All testing should be performed under biosafety level 2 conditions.

COXIELLA SPECIES

Coxiella burnetii, first isolated in the 1930s, was originally classified in the family *Rickettsiaceae* because of its intracellular replication, small size, staining characteristic, and isolation from ticks. Additional studies found that this organism has unique characteristics and is genetically distinct. Infections with *C. burnetii* can result in Q fever, which is usually an airborne infection in humans, although ticks occasionally serve as the vectors. *C. burnetii* infects macrophages and develops inside phagolysosomes. This organism has small-cell variants, measuring 0.2 by 0.5 μm , that do not divide but are infectious and act like spores, and large-cell variants, measuring 0.4 to 1.5 μm by 0.2 to 0.5 μm , that divide by binary fission. *C. burnetii* is widespread in nature and can survive for many years under harsh environmental conditions. Farm animals, including cattle, sheep, and goats, in addition to dogs, cats, and rabbits, are the main reservoirs. Infections in humans are, for the most part, the result of aerosol transmission during delivery of an infected animal or the result of drinking raw cow's or goat's milk. The dose required for human infection is only 1 to 10 viable *C. burnetii* cells, and therefore, it is very easy for persons handling animals to get infected. In the United States, the seropositivity in the general population is 3%, while that in veterinarians is 22%. In Canada and the Netherlands, workers that farm animals have a seropositivity rate of 60 to 70%.

Most infections in humans are asymptomatic, although in a few cases acute and chronic forms of the disease produce manifestations. The acute infection usually appears, after a 3-week period of incubation, as fever, chills, headaches, and myalgias. An atypical pneumonia can develop, and some patients have hepatosplenomegaly. A liver biopsy on these patients will show a typical doughnut-shaped (or ring) fibrin granuloma. Subacute endocarditis, which occurs in patients with prior heart damage, is the most common manifestation of chronic Q fever. Chronic infections occur mainly in immunocompromised patients. Also, a postinfectious chronic fatigue syndrome has been recognized. In pregnant females, *C. burnetii* can infect the placenta and the fetus, leading to abortion.

During the acute phase of the infection the laboratory diagnosis of Q fever is usually made serologically by testing acute- and convalescent-phase serum samples and using infected monolayers as the antigen. The indirect immunofluorescent-antibody assay is the test of choice for determination of infection, but enzyme-linked immunosorbent assays also have good specificity and

sensitivity. This organism undergoes phase variation; as a result, antibodies to phase I and II antigens can be detected. Phase I strains have intact lipopolysaccharide antigens, while phase II strains do not have complete lipopolysaccharide antigens. During the acute response, the antibodies are directed mainly to phase II antigens, while in chronic infections, the antibody response is mixed against phase I and II antigens. Seroconversion, or the presence of specific immunoglobulin M, is diagnostic for acute primary Q fever. The diagnosis of a chronic infection can be made when titers to phase I antigens are 1:800 or greater. Manipulation of infected animals and growth of this organism should be done only in biosafety level 3 facilities due to the low infectious dose of the agent and the potential for generating

aerosols. Cultures can be performed using tissue culture in shell vials and infecting cell monolayers, such as Vero and HEL cells. Embryonated egg yolk sacs and inoculation into laboratory animals, such as mice and guinea pigs, can also be used. Direct immunofluorescence can be used to directly detect *C. burnetii* in tissue samples from patients with endocarditis. NAAT are now available to detect and identify this organism. During the first 2 weeks of infection, NAAT are positive in blood and serum, while in the chronic stage of the disease, tissues, such as cardiac valves, can give positive results. Other tests recommended for the diagnosis of the chronic phase include echocardiography and ^{18}F -fluorodeoxyglucose positron emission tomography-computed tomography.

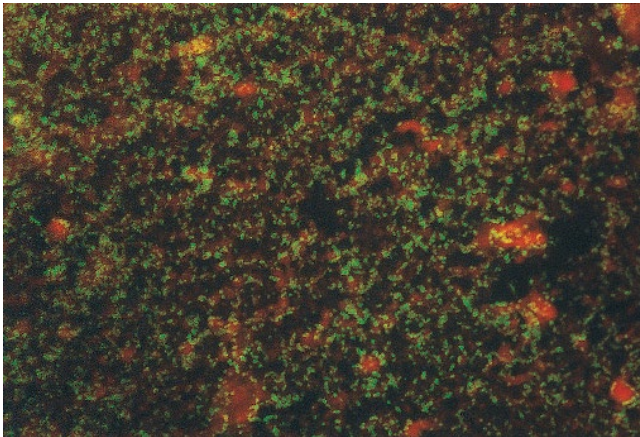
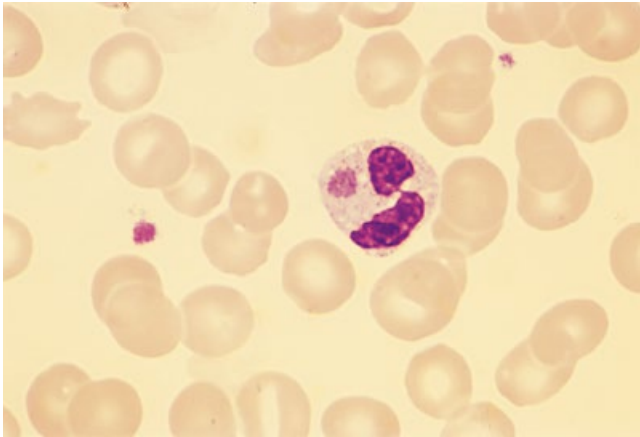
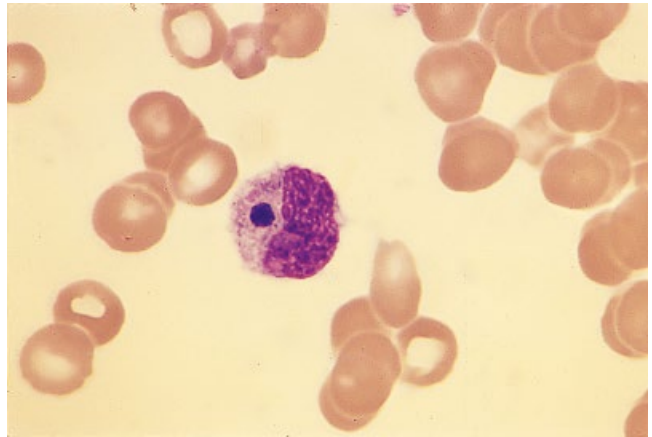


Figure 36-1 Microimmunofluorescence test for antibodies to *Rickettsia*. To perform the microimmunofluorescence assay, suspensions of the rickettsial antigens to be tested are fixed on a multiwell glass slide. The serum sample is placed on the slide and incubated, and a fluorescein-labeled anti-human immunoglobulin antibody is then added. A positive reaction shows fluorescing green microorganisms of the species with which the patient was infected. Shown here, the antigen detected was *R. rickettsii*.



A



B

Figure 36-2 Wright-stained peripheral blood smears showing morulae of *Ehrlichia ewingii* (A) and a buffy coat preparation demonstrating morulae of *Ehrlichia chaffeensis* (B). In peripheral blood of patients with ehrlichiosis, it is occasionally possible to detect the morulae produced by *E. ewingii* in granulocytes or those produced by *E. chaffeensis* in monocytes. As shown here, the morulae are small (2 to 3 μm in greatest diameter), basophilic, intracytoplasmic inclusions. These inclusions represent membrane-bound clusters of ehrlichiae replicating in the cytoplasm of the infected cell. (Blood smears courtesy of Christopher Paddock, Centers for Disease Control and Prevention, Atlanta, GA.)

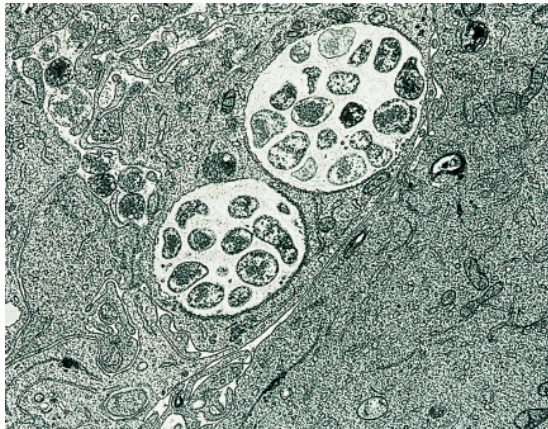


Figure 36-3 Electron micrograph of a monocyte infected with *Ehrlichia chaffeensis*. This electron micrograph shows two intracytoplasmic inclusions produced by *E. chaffeensis*. The morulae can eventually be extruded from the monocyte. (Courtesy of Ted Hackstadt, Rocky Mountain Laboratories, National Institute of Allergy and Infectious Diseases, Hamilton, MT.)

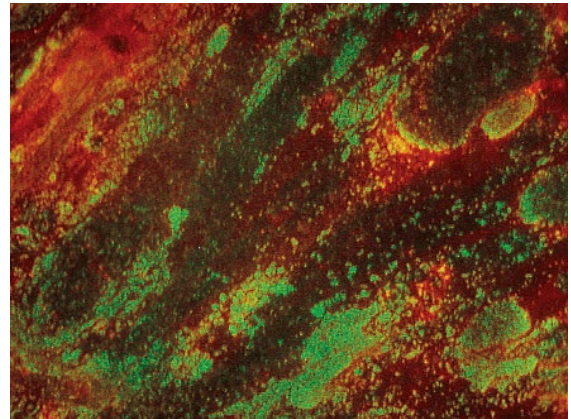


Figure 36-4 Shell vial culture of *Coxiella burnetii* stained with a fluorescence-labeled monoclonal antibody. A monolayer of HEL cells was inoculated with a positive sample and stained after 7 days with a specific fluorescence-labeled monoclonal antibody. The stain shows the organisms growing inside the phagolysosome. (Courtesy of Philippe Broughi, Unité des Rickettsies, CNRS UPRESA, Marseilles, France.)

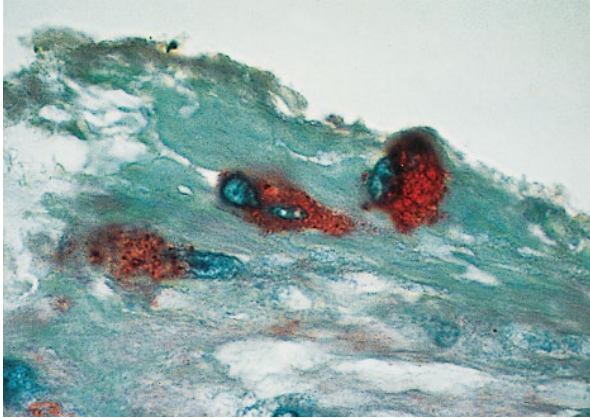


Figure 36-5 Heart section from a patient with endocarditis due to *Coxiella burnetii*. An alkaline phosphatase immunohistochemical stain of a human cardiac valve from a patient with *C. burnetii* endocarditis is shown. The organisms stain pink within the mononuclear cells. (Courtesy of J. Stephen Dumler, The Johns Hopkins Medical Institutions, Baltimore, MD.)

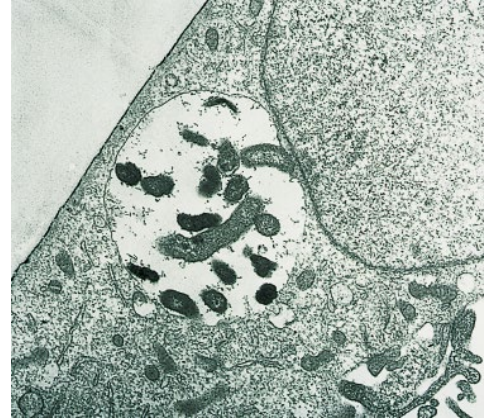


Figure 36-6 Electron micrograph of *Coxiella burnetii*. A cell infected with *C. burnetii* in culture is shown. Multiple organisms can be observed inside the cytoplasmic vacuole. (Courtesy of Ted Hackstadt, Rocky Mountain Laboratories, National Institute of Allergy and Infectious Diseases, Hamilton, MT.)



Figure 36-7 Female lone star tick, *Amblyomma americanum*. *A. americanum* is a hard-shell tick that transmits *R. rickettsii* (RMSF) and *E. chaffeensis* and is also a vector for *Borrelia lonestarii*. It is distributed throughout the United States, although it is most frequently found in Texas and Louisiana. As shown here, this tick can be identified by the white spot (lone star) on its back. (Specimen provided by Alan G. Barbour, University of California, Irvine, CA.)

Tropheryma whipplei

37

Tropheryma whipplei is a member of the *Actinobacteria* distantly related to *Mycobacterium avium-Mycobacterium intracellulare* and *Mycobacterium paratuberculosis*, and this may explain some of the similarities between the clinical presentations of infections with these organisms.

T. whipplei is a Gram-positive bacillus that stains poorly with Gram stain and is negative with acid-fast staining. *T. whipplei* causes Whipple's disease, which was originally described as an intestinal lipodystrophy. Whipple's disease is characterized by diarrhea, weight loss, abdominal pain, lymphadenopathy, fever, arthralgia, and skin pigmentation. *T. whipplei* has also been found in several parts of the body, including the heart, brain, eyes, large joints, skin, and lungs. Almost 80% of patients affected are middle-aged male Caucasians. If the disease is not treated with antibiotics, the patient can develop malabsorption, which can be fatal. Antibiotic treatment can result in development of immune reconstitution inflammatory syndrome (IRIS) in ~10% of patients. Farmers are often affected, suggesting that the infection is acquired from animals and soil. Human-to-human transmission by the oral-oral and fecal-oral

routes has also been described. This organism can be found in healthy humans, and depending on the immunogenetic background of the individual, he or she can remain asymptomatic or develop the disease.

Histologically, the typical finding includes foamy macrophages infiltrating the lamina propria of the small intestine that are positive with periodic acid-Schiff (PAS) stain. Extracellular bacteria can also be present. Immunohistochemistry assays using rabbit anti-*T. whipplei* are more sensitive and specific than PAS staining. Due to possible false-positive and -negative results with the PAS stain, specimens should also be tested by a nucleic acid amplification test (NAAT). In the absence of histopathological findings, a positive NAAT for this organism should be interpreted cautiously if no clinical symptoms are present. Specimens from the stools, saliva, cerebrospinal fluid, synovial fluid, vitreous fluid, skin, heart, and lungs can be tested by NAAT in research laboratories. *T. whipplei* has been cultured in some tissue culture systems and artificial media, but this approach has low sensitivity, and it takes 4 to 6 weeks to detect growth. No serological tests are available to evaluate antibodies to *T. whipplei*.

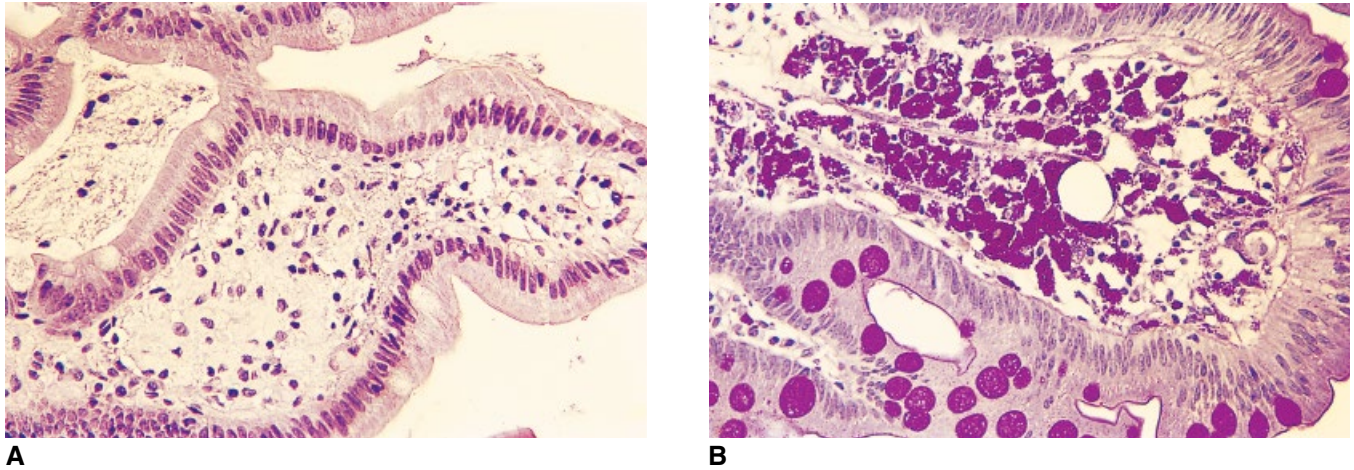


Figure 37.1 Small intestine biopsy specimen from a patient with Whipple's disease. *T. whipplei* causes Whipple's disease, characterized by the presence of large quantities of histiocytes in the lamina propria of the intestinal mucosa, which contains numerous organisms. (A) Extracellular bacilli are also found below the basal lamina of the epithelial cells, and the number of organisms diminishes toward the submucosa. This specimen was stained with hematoxylin and eosin stain. (B) Macrophages containing *T. whipplei* have a coarsely granular material that stains intensely with PAS. Magnification, $\times 250$.

Antimicrobial Susceptibility Testing

38

Antimicrobial susceptibility testing (AST) is one of the most important functions of the clinical microbiology laboratory in that it provides information to the clinician to guide selection of appropriate antimicrobial therapy. While there are several methods that can be used to perform AST, in general they are based on the same principles. Whether AST is performed using a totally manual or a fully automated system, or a combination of the two, methods must be reproducible and follow the basic principles outlined in published guidelines, whether they be from the Clinical and Laboratory Standards Institute, the U.S. Food and Drug Administration, or the European Committee on Antimicrobial Susceptibility Testing. With advances in technology using molecular methods, selected resistance genes or their products can be detected using nucleic acid amplification testing (NAAT), hybridization, or immunological or enzymatic methods which serve as a rapid means of identifying isolates with these resistance mechanisms.

The majority of AST is performed to establish the minimal inhibitory concentration (MIC) of an antimicrobial. MICs have been established for many drug-organism combinations. The MIC can be determined by broth macro- or microdilution or an agar assay. Here, antimicrobials are diluted in broth or in agar and inoculated with a standard concentration of organism. The lowest antimicrobial concentration at which the growth of the organism is macroscopically inhibited is defined as the MIC. Disk diffusion, also referred to as the Kirby-Bauer method, named after the individuals who proposed this approach, relies on paper disks impregnated with a set concentration

of antimicrobial(s). Disks are placed on a solid medium, e.g., Mueller-Hinton agar, that has been inoculated with a standardized lawn of bacteria. Upon incubation, the antimicrobial diffuses into the medium in a circular fashion. If the antimicrobial inhibits the growth of the organism, a zone of inhibition is created around the disk and is measured in millimeters after a specified incubation time. The Etest (previously known as the Epsilonometer test) is also performed on solid media. Here, a plastic strip that has been impregnated with a gradient of antimicrobial is placed on a standardized lawn of bacteria. If bacteria are inhibited by the antimicrobial, a zone of inhibition forms around the strip, resembling an ellipse. The concentration at which the interface of the zone of inhibition and growth crosses the strip is indicative of the MIC. In addition, several manufacturers have automated some or all the steps taken in these different AST methods.

Breakpoints are set for each antimicrobial as to the MIC (in micrograms [or units] per milliliter) or zone diameter (in millimeters) that corresponds to the likelihood that the antimicrobial will be effective *in vivo*. The interpretation of the MIC or zone diameter can be one of the following: susceptible, meaning that there is a high likelihood of therapeutic success; susceptible-dose dependent, indicating that higher or more frequent dosing may be required to be effective; intermediate, referring to a zone between susceptible and resistant where, if the drug is used for treatment in some settings, it may be adequate but caution must be taken to monitor for treatment failure; resistant, meaning the antimicrobial has a high probability of clinical failure; and nonsusceptible, a term used for

isolates where only susceptibility breakpoints have been established due to a lack of resistant strains. Interpretations are based on several factors, including the MIC distribution of known strains, clinical outcomes, pharmacodynamics, pharmacokinetics, and *in vitro* data. AST does not account for many of the *in vivo* factors such as drug delivery to the site of infection, host immune response (or lack thereof), and polymicrobial interactions.

The MIC and disk diffusion methods may fail to detect emergent resistant organisms or organisms that have the potential to be resistant due to an inducible resistance gene. Phenotypic tests in which the basic susceptibility techniques have been modified are used to predict whether an organism is capable of growing in the presence of a given antimicrobial or class of antimicrobials. An example of this is the D test, which is used to check for inducible clindamycin resistance, where, in the presence of erythromycin, organisms may be induced to express genes that confer resistance to clindamycin that would not have been detected using clindamycin alone. Phenotypic tests have also been employed for detecting organisms that produce an extended-spectrum β -lactamase (ESBL) or carbapenemase. Enzymatic assays are also used to detect or predict resistance to β -lactam antibiotics, including the carbapenems. With *Staphylococcus*, assays using antibodies to penicillin-binding protein 2a (PBP2a), the product of the *mecA* gene, are used to detect methicillin-resistant strains. Antibody-based assays have also been developed to detect the different classes and types of carbapenemases.

Screening tests are commonly employed to identify patients colonized with a specific organism that is resistant to a particular class of antimicrobials. Screening is commonly performed using selective and differential media or NAAT. Examples of this are the screening of nasal swabs for methicillin-resistant *Staphylococcus aureus* and rectal swabs for vancomycin-resistant *Enterococcus* spp. or fluoroquinolone- or carbapenem-resistant members of the *Enterobacterales*.

Molecular testing has been limited mainly by the complexity of genes that code for resistance to certain antimicrobials. However, clustered mutations have made it possible to focus on genes that have regions that are responsible for selected resistance mechanisms expressed by a particular organism toward an antimicrobial or class of antimicrobials. Common resistance genes tested for are the *mecA* gene in methicillin-resistant *Staphylococcus aureus*, *vanA* and *vanB* genes in *Enterococcus* species, select ESBL genes in members of the *Enterobacterales*, carbapenemase genes in Gram-negative organisms, and the *rhoB* gene in rifampin-resistant *Mycobacterium tuberculosis*. Most of these genes, where appropriate,

have been incorporated into NAAT panels for direct testing of clinical specimens as well as positive blood cultures to rapidly detect resistant organisms.

Less common tests that can be useful in certain clinical situations include the determination of minimum bactericidal concentration (MBC). In a procedure similar to that for establishing a MIC, bacteria are added to known concentrations of an antimicrobial, and after overnight incubation, broth cultures are subcultured to an agar medium free of antimicrobial. This allows one to determine the MBC, the lowest concentration of antimicrobial that kills 99.9% of the original inoculum.

Testing for synergy between two antimicrobials can be accomplished using a macrodilution or microwell method, where various concentrations of each antimicrobial in combination and alone are tested against a standardized suspension of bacteria. Drug combinations whose effect is greater than the sum of the effects of each drug alone are considered synergistic combinations. Testing for synergy using a single high concentration (500 $\mu\text{g/ml}$ or higher) of an aminoglycoside is commonly performed with *Enterococcus* spp. when this drug class is being considered as a treatment for endocarditis. Here, susceptibility to the single high concentration of an aminoglycoside is predictive of effective treatment when the drug is used at therapeutic levels, i.e., low levels, with a cell wall-active antimicrobial.

In the serum bactericidal test, or Schlichter test, a patient's blood is drawn when the antimicrobial he or she has been receiving is at the lowest concentration, referred to as the trough, and also when the antimicrobial should be at the highest concentration, the peak. The patient's trough and peak serum samples are diluted in a nutrient broth to which a standardized solution of bacteria that was isolated from the patient's blood, or other appropriate culture, is added. The broths are incubated overnight and then read for turbidity. The titer is established as the highest dilutions of peak and trough sera that inhibit the growth of the organism. However, limited data exist to support the use of bactericidal assays in the management of complicated bacterial infections.

Due to the low growth rate of *Mycobacterium* spp., specialized susceptibility assays are required, with the majority being focused on *M. tuberculosis*. In addition to the agar proportion method, which is still referred to as the gold standard, some liquid-based systems, e.g., BACTEC MGIT (mycobacterial growth indicator tube) 960 (BD Diagnostic Systems, Franklin Lakes, NJ) and MB/BacT Alert 3D (bioMérieux, Inc., Durham, NC), have also been standardized to test first-line drugs for the treatment of *M. tuberculosis*. As mentioned above,

molecular methods targeting the rifampin resistance-determining region of the *rpoB* gene and gene targets known to contribute to isoniazid resistance have been successfully used to rapidly identify strains that are resistant to these first-line antimicrobials against *M. tuberculosis*. The Centers for Disease Control and Prevention has recommended that first-time sputum specimens from all

patients suspected of having tuberculosis be tested by a molecular test in addition to traditional smears and culture. Many of these molecular tests also incorporate testing for rifampin and in some cases isoniazid resistance genes. Additionally, DNA sequencing has been used to predict profiles of susceptibility to first-line antituberculosis drugs with a faster turnaround time.

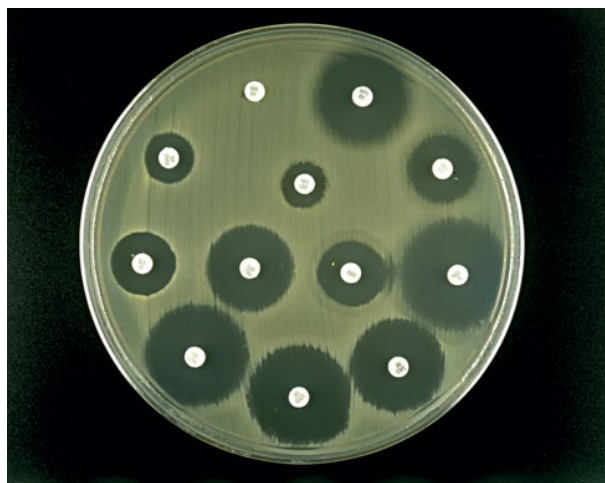
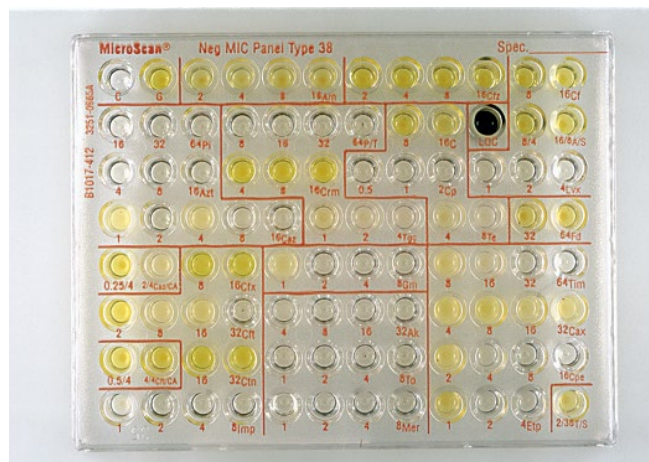


Figure 38-1 Disk diffusion (Kirby-Bauer) antimicrobial susceptibility test. In the disk diffusion method, a lawn of bacteria is spread onto a 150-mm Mueller-Hinton agar plate and paper disks impregnated with antimicrobial agents are placed onto the bacterial lawn. The plate is incubated at 35°C for 16 to 24 h, depending on the organism being tested; it is then examined, and the zones of bacterial growth inhibition are measured. This *Escherichia coli* isolate is resistant to ampicillin, as indicated by growth up to the disk and therefore no zone of inhibition, i.e., 6 mm, the diameter of the disk. For the remainder of the antimicrobial agents, the zone diameters of inhibition are measured in millimeters, and an interpretation of susceptible, intermediate, or resistant is made by comparing the zone with the established breakpoints for that particular antimicrobial-organism combination.



Figure 38-2 Disk diffusion (Kirby-Bauer) antimicrobial susceptibility test using Mueller-Hinton-blood agar. Rapidly growing organisms are usually tested on unsupplemented Mueller-Hinton agar, as shown in Fig. 38-1. However, more fastidious organisms, especially members of the genus *Streptococcus*, shown here, are tested on Mueller-Hinton supplemented with 5% sheep blood in order to improve growth. This organism is resistant to oxacillin as shown by the bacterial lawn growing right to the edge of the antimicrobial-containing disk. For the other seven antimicrobials, the zone diameters are measured and compared to breakpoints for this antimicrobial-organism combination to determine if the organism is susceptible, intermediate, or resistant to a given antimicrobial.

Figure 38-3 MIC testing by microdilution. The antimicrobial susceptibility assay shown here using *Pseudomonas aeruginosa* is performed in a microtiter plate. Serial dilutions of various antimicrobial agents are made in the microtiter plate. The plate is then inoculated with a standardized suspension of bacteria and incubated for 16 to 24 h at 35°C, and the individual wells are examined for growth. The MIC of a particular antimicrobial agent is the lowest concentration that inhibits visible growth. As with disk diffusion, MICs are compared to established standards to determine if the organism is susceptible, intermediate, or resistant to an antimicrobial agent. The dark well aids in orienting the plate to facilitate matching the wells with the correct antimicrobial and concentration.



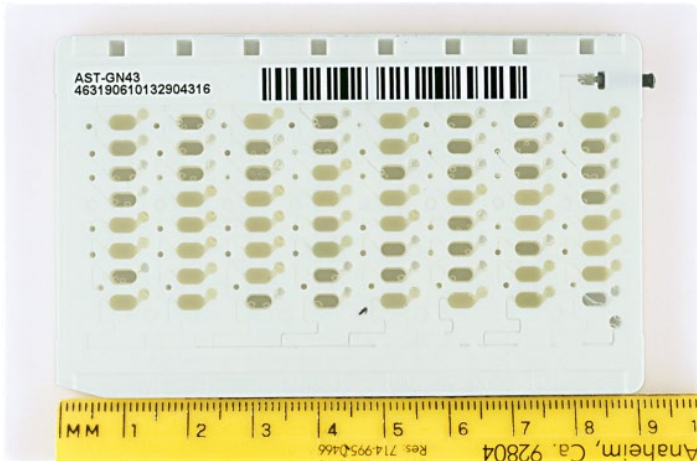


Figure 38-4 Automated AST. Several systems are available for automated AST. Shown here is an antimicrobial susceptibility card used in the Vitek system (bioMérieux, Inc., Durham, NC). A standardized suspension of bacteria is used to inoculate a small card that contains several antimicrobial agents at various concentrations. The card is then incubated in the Vitek reader/incubator and monitored by the instrument for bacterial growth. The instrument takes the readings, converts them into MICs, and provides an interpretation (susceptible, intermediate, or resistant).

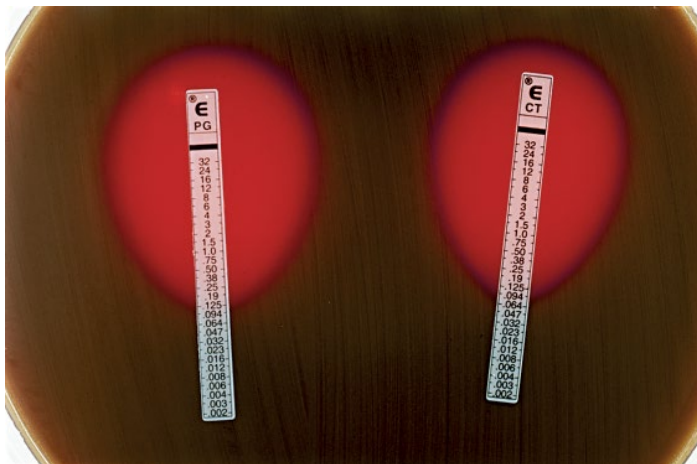


Figure 38-5 Etest. AST by the Etest is performed on solid media such as Mueller-Hinton agar or Mueller-Hinton agar supplemented with 5% sheep blood (shown). A standardized solution of bacteria is used to create a lawn of bacteria on the agar plate. A strip that contains a gradient of a particular antimicrobial is then laid over the bacterial inoculum. After incubation for 16 to 24 h at 35°C, the antimicrobial concentration at which the elliptical zone of bacterial inhibition intersects the antimicrobial strip is read as the MIC. The MIC is then compared to a standard chart for interpretation (susceptible, intermediate, or resistant). The organism pictured has a penicillin MIC (left strip) and a cefotaxime MIC (right strip) of 0.126 µg/ml.

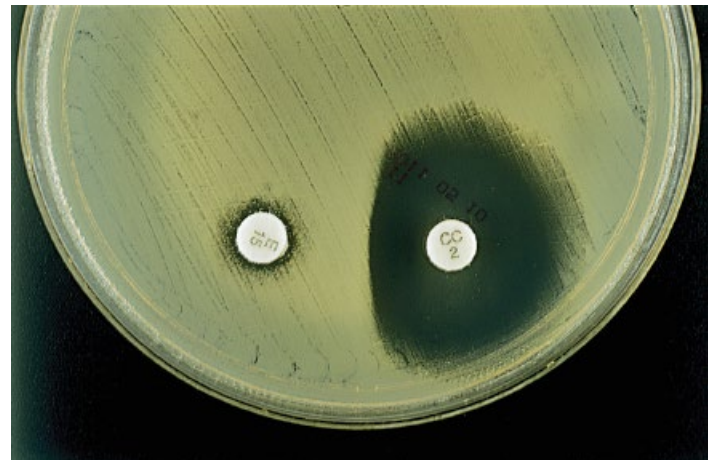


Figure 38-6 Screen plate to check for vancomycin-resistant *Enterococcus* spp. The plate shown here contains 6 µg/ml of vancomycin and is used to screen for isolates of *Enterococcus* spp. that are resistant to this antimicrobial (MIC, >6 µg/ml). Multiple isolates can be tested on the same plate by spotting standardized suspensions of isolates. On the plate shown here, there are four vancomycin-resistant *Enterococcus* isolates, as indicated by growth where the inoculum was placed; the other isolates inoculated on the plate are vancomycin-susceptible isolates.

Figure 38-7 The D test, a phenotypic test to assess inducible clindamycin resistance. Phenotypic tests are often used to identify organisms that have the potential to express resistance *in vivo*, especially under antimicrobial pressure. While a definitive test would be DNA sequencing to identify genes or mutations that encode resistance mechanisms, at present this is not a practical approach. Standardized MIC or disk diffusion tests may fail to detect these isolates. Shown is the D test, in which erythromycin is used to test whether an isolate possesses the ability to express the *erm* gene, rendering it resistant to clindamycin. (A) The isolate is resistant to erythromycin but susceptible to clindamycin, indicating that erythromycin was not able to induce *erm* gene expression. This isolate is therefore most likely resistant to erythromycin due to an efflux mechanism commonly coded by the *msrA* gene. (B) This isolate is also resistant to erythromycin, but here the *erm* gene is expressed, which alters ribosome functioning and renders the isolate resistant to both erythromycin and clindamycin. This is indicated by a flattening of the zone of inhibition around clindamycin in the area adjacent to the erythromycin disk, making the zone of inhibition around clindamycin appear in the shape of the letter D, indicating erythromycin induced the expression of resistance to clindamycin.



A



B

Figure 38-8 Phenotypic test for an ESBL. Traditional AST can miss the fact that an organism possesses the ability to express an ESBL. A phenotypic test for ESBL production by an organism can be performed using disks impregnated with ceftazidime and cefotaxime and disks containing both the cephalosporin and clavulanic acid, which can bind to and inactivate the ESBL enzyme. If the zone diameter increases by ≥ 5 mm in the presence of clavulanic acid in comparison to the cephalosporin disk without clavulanic acid, then it is assumed the organism expresses an ESBL. Shown is a *Klebsiella pneumoniae* isolate that is an ESBL producer, since both the disks containing cefotaxime plus clavulanic acid (top right) and ceftazidime plus clavulanic acid (bottom right) have zone diameters >5 mm larger than those of the cephalosporins cefotaxime (top left) and ceftazidime (bottom left) alone.



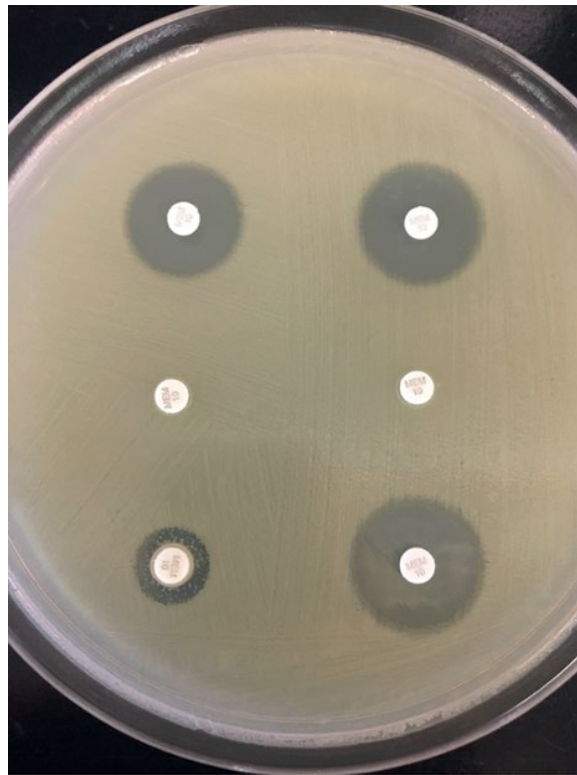


Figure 38-9 Modified carbapenem inactivation method (mCIM). An example of a phenotypic method for the detection of an isolate with a suspect carbapenemase can be seen here. The mCIM test is performed by incubating the test organism at 35°C for 4 h in 2 ml of broth medium, e.g., Trypticase soy broth, to which a 10- μ g meropenem disk has been added. To a duplicate set of tubes 0.02 ml of 0.5 M EDTA can also be added to assess whether the isolate has a metallo-carbapenemase (metallo- β -lactamase). The test which includes addition of EDTA along with the meropenem disk is referred to as the eCIM. In order to interpret the result, if the eCIM is performed, the mCIM must be run in parallel. After the 4-h incubation period, the meropenem disks are removed from the broths. Subsequently, the disks are placed on a Mueller-Hinton agar plate within 15 min of inoculation with a lawn of a carbapenem-susceptible *Escherichia coli* ATCC 25922. The plate is then incubated at 35°C in ambient air for 18 to 24 h. The disks on the left side were all incubated with isolates without the addition of EDTA, while EDTA was added to those on the right side of the plate. Three *Klebsiella pneumoniae* isolates were tested: a carbapenem-susceptible strain (top), a *K. pneumoniae* carbapenemase (KPC)-producing strain (middle), and a strain with a New Delhi metallo- β -lactamase 1 (NDM-1) (bottom). The isolate at the top was susceptible to all carbapenems and served as a negative control (no carbapenemase) for the mCIM and eCIM assays. The middle isolate produced a carbapenemase, since meropenem was inactivated during the broth incubation, resulting in no zone of inhibition of the indicator *E. coli* strain. Addition of EDTA did not inhibit the carbapenemase of this strain, since there was no difference in zone size compared to the matching disk on the left without EDTA. The isolate at the bottom possessed a metallo-carbapenemase, since the addition of EDTA (right) inhibited the metallo-carbapenemase, which requires zinc in the active site, resulting in a larger zone of inhibition than that on the left. mCIM is currently validated for *Enterobacterales* and *P. aeruginosa* and eMIC for *Enterobacterales* only.

Figure 38-10 Phenotypic test for β -lactamase production. Testing for the enzyme β -lactamase can be performed using a disk impregnated with nitrocefin, a chromogenic cephalosporin. If an organism possesses β -lactamase, which is able to hydrolyze the β -lactam ring of the penicillinase-labile penicillins, the chromogenic portion of this substrate is released, turning the disk from yellow to red, as shown here.

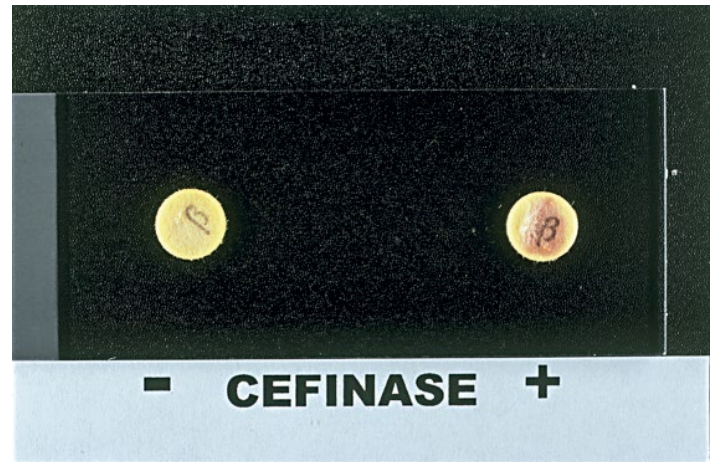


Figure 38-11 The NG-Test CARBA 5 phenotypic assay for carbapenemase detection. The NG-Test CARBA 5 is a multiplex immunochromatographic assay for the detection and differentiation of five carbapenemases (KPC [K], OXA-48 [O], VIM [V], IMP [I], and NDM [N]). Here, colonies from three isolates grown on sheep blood agar were suspended in extraction buffer, vortexed, and added to the test device. After 15 minutes the results were read. The isolate on the left is negative for all of the five carbapenemases tested, since only the control window (C) is positive. The test device in the middle detected an isolate with a KPC-type carbapenemase, since both the control and the “K” windows are positive. The isolate on the right carries a New Delhi metallo- β -lactamase 1 (metallo-carbapenemase), since both the control and “N” windows are positive. (Courtesy of Hardy Diagnostics, Santa Maria, CA.)



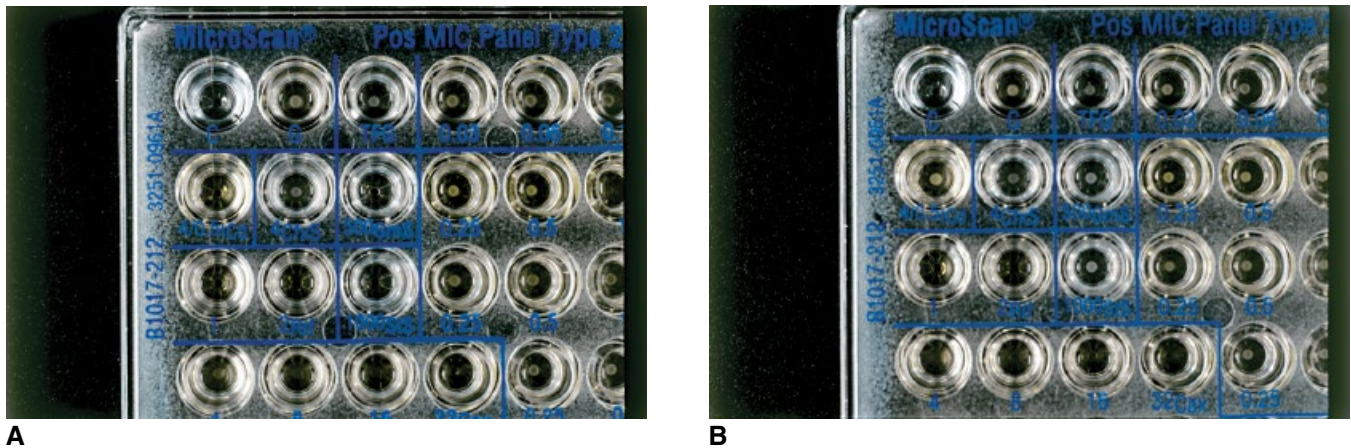


Figure 38-12 Synergy testing of *Enterococcus* species using high levels of aminoglycosides. Serious enterococcal infections may require treating a patient with an aminoglycoside and a cell wall-active antimicrobial. To predict whether the aminoglycoside would be synergistic with the cell wall-active antimicrobial, an *in vitro* synergy test can be performed. In this test, microtiter wells containing a single high concentration of gentamicin (GmS; 500 $\mu\text{g/ml}$) or streptomycin (StS; 1,000 $\mu\text{g/ml}$) are incorporated into a microtiter plate, as shown in Fig. 38-3. All wells of the microtiter plate are inoculated with a standardized suspension of the enterococcal isolate. After overnight incubation, the wells are read for visible signs of growth. The result of no growth in the GmS and StS wells for the isolate in panel A (row 2, well 3; row 3, well 3) predicts that the aminoglycosides will have a synergistic effect with a cell wall-active agent. In contrast, with the isolate in panel B, there is a button of growth in both aminoglycoside-containing wells (row 2, well 3; row 3, well 3), predicting a lack of synergy with cell wall-active antimicrobials.

Molecular Diagnosis of Bacterial Infections

39

The ability of the clinical microbiology laboratory to detect and identify bacterial pathogens in a timely fashion has been limited, for the most part, by the low number of organisms present. For example, fewer than 5 CFU of a bacterium are usually present per ml of blood in patients with septicemia. In addition, some pathogens grow slowly due to their unique metabolic requirements, which causes their identification to be delayed. An example of this is *Mycobacterium* sp., which can take up to 8 weeks to be detected on culture media.

Urine is cultured and evaluated today using methods similar to those employed in the 1950s. However, since that decade, new technologies have been developed that have begun to revolutionize diagnostic bacteriology. It is not one branch of science or a unique technology that is making this change possible, but the convergence and integration of several of them. These technological advances are contributing to a major shift that is changing the way we practice diagnostic medical microbiology. From a fairly subjective art form, diagnostic bacteriology is evolving into an objective, chemically based science.

Some of the driving forces behind this change are our understanding of the biochemistry of microorganisms, our ability to rapidly amplify their nucleic acids, and the capacity to identify unique molecular signatures of each pathogen. In the late 19th century, Friedrich Miescher, a Swiss physician, first isolated and identified nucleic acids, and Albrecht Kossel, a German biochemist, found that nucleic acids are long-chain polymers of nucleotides made up of sugar (ribose in RNA and deoxyribose in DNA), phosphoric acid, and nitrogen-containing

bases (adenine, cytosine, and guanine, plus thymine in DNA or uracil in RNA). In 1944, Oswald Avery, Colin MacLeod, and Maclyn McCarty discovered that DNA is the component that causes bacterial transformation. It had been shown that inoculation of a killed form of the virulent *Streptococcus pneumoniae* type III-S strain into a test animal along with live organisms of nonvirulent *S. pneumoniae* type II resulted in a lethal infection due to the type III strain. Avery et al. extracted the virulent DNA and proved that it caused the infection. Until then, proteins had been thought to be the hereditary constituent of bacteria.

Less than 10 years after this discovery, James Watson and Francis Crick proposed a model for the structure of DNA. Based on X-ray diffraction data from Rosalind Franklin, showing that DNA has a helical structure with the phosphates on the outside, and Edwin Chargaff's findings about base pairs, Watson and Crick proposed a model with two chains of nucleotides, each in a helix oriented in an opposite direction and the matching bases interlocked in the middle of the double helix. Furthermore, Watson and Crick showed that each strand of the DNA was a duplicate of the other. They proposed that during cell division the DNA splits, with each strand acting as a template for a new strand, and by this means DNA can reproduce and maintain its structure. Soon after, Arthur Kornberg discovered DNA polymerase, an enzyme able to catalyze the template-directed synthesis of DNA. Julius Marmur, Paul Doty, and other investigators discovered DNA renaturation, which led to the study of nucleic acid homologies between organisms by using DNA-DNA and DNA-RNA hybridization.

From then on, our ability to characterize and manipulate nucleic acids quickly expanded. In the early 1970s, Daniel Nathans, Werner Arber, and Hamilton Smith discovered restriction endonucleases. These enzymes, found in bacteria, cut foreign DNA at specific recognition nucleotide sequences, those acting as a defense mechanism against invading viruses. The availability of restriction enzymes allowed Stanley N. Cohen and Herbert W. Boyer to develop recombinant DNA technology, “cutting and pasting” pieces of DNA from one organism into the DNA of other organisms. In 1970, Howard Temin and David Baltimore independently described the activity of a new enzyme, reverse transcriptase. This enzyme transcribes single-stranded RNA (ssRNA) into single-stranded DNA (ssDNA). Due to its RNase activity, it also degrades the original RNA. Subsequently, a second DNA strand complementary to the reverse-transcribed ssDNA is then synthesized. The discovery of reverse transcriptase contradicted the accepted unidirectional dogma that DNA was transcribed into RNA, which was then translated into proteins.

Additional methods were developed through the 1970s to further characterize RNA and DNA. New sequencing methods and studies included those of Walter Fiers to sequence RNA; the approach of Allan Maxam and Walter Gilbert, based on the chemical modification of DNA followed by cleavage at specific bases; and the chain-termination method of Frederick Sanger. The Maxam-Gilbert method was subsequently replaced by Sanger’s technique when dideoxynucleotide triphosphates (ddNTPs) as DNA chain terminators became available. The development of fluorescence-labeled ddNTPs and primers by the laboratory of Leroy Hood greatly facilitated the implementation of automated high-throughput DNA sequencing using the Sanger method.

The introduction of next-generation sequencing (NGS), deep sequencing, and massively parallel sequencing, which are all related, was the next step that revolutionized genomic research. Several platforms are available that allow the sequencing of millions of small fragments of DNA in parallel (e.g., Illumina, Roche 454 pyrosequencing, and the Ion Torrent: Proton/PGM sequencer). These sequences are then put together by bioinformatics analyses. Because the same base pairs of a genome are sequenced several times, the data are highly accurate. Implementation of NGS is having a major impact on bacterial taxonomy and other fields.

A new turning point occurred in 1983, when Kary Mullis came up with the idea of using a pair of primers to bracket a DNA sequence of interest that then could be amplified by using DNA polymerase. One limitation of the initial method was that the DNA polymerase was inactivated by the high temperature necessary to separate the two DNA strands, a necessary step to perform the polymerase chain reaction (PCR). It was Mullis again who in 1986 had the idea of using *Thermophilus aquaticus* DNA polymerase, which is heat resistant and therefore can withstand the high temperatures necessary to denature double-stranded DNA (dsDNA). Since then, several alternatives to the original PCR technique have been developed, including real-time, multiplex, nested, and digital PCR, that have expanded the applications of this nucleic acid amplification method in the clinical laboratory.

Over the decades since then, new methods have been developed to amplify and characterize nucleic acids. These new approaches have simplified the application of these technologies, making them practical for use in the clinical laboratory. An important driving force behind many of these efforts was the appearance of the HIV-1 epidemic. A worldwide public and private effort was focused on identifying the cause of this disease and then on diagnosing and managing the infection. The application of molecular techniques played a critical role in these efforts.

A recent finding in archaea and bacteria with major implications in biology, including diagnostic microbiology, is clustered regularly interspaced palindromic repeats (CRISPR), described by Francisco Mojica in 1993. While working with *Haloferax mediterranei*, a member of the archaea that is highly tolerant to salt, this investigator found multiple copies of a repeated DNA sequence of 30 bases, roughly palindromic, separated by spacers of approximately 36 bases. After detecting these structures in more than 20 bacterial species, including *Yersinia pestis*, *Mycobacterium tuberculosis*, and *Clostridioides difficile*, Mojica found that in a particular strain of *Escherichia coli*, the spacer sequence matched that of the P1 phage that infects *E. coli*. Interestingly, this particular strain of *E. coli* was known to be resistant to P1 infection. After characterizing multiple spacers it was determined that they matched the DNA sequences of bacteriophages, transposons, and plasmids related to the bacteria carrying the spacer. Based on these findings, Mojica proposed that CRISPR likely represented a heritable, adaptive immune system that protects bacteria

against specific infections. Subsequently, it was discovered that Cas nucleases, guided by CRISPR RNA (crRNA) and transactivating RNA, produce double-strand breaks in DNA. Thus, the spacer sequences acquired from invading genetic elements are later used to guide Cas proteins to eliminate foreign genetic invaders. Virginijus Šikšnys determined that the CRISPR system of *Streptococcus thermophilus* could be reconstituted in *E. coli*, establishing that the critical components of the CRISPR-Cas9 system were the Cas9 nuclease, the crRNA, and the transactivating RNA. Jennifer Doudna and Emmanuelle Charpentier modified the Cas9 endonuclease by fusing the two RNAs. In addition, by changing the nucleotide sequence of the RNA, they determined that it could be programmed to target any DNA sequence for cleavage. In 2013, Fen Zhang and George Church, independently using CRISPR, were the first to modify the genome of human culture cells, making gene editing in humans feasible.

The diagnostic applications of the CRISPR technology are evolving very rapidly and are being tested in various settings. For example, it has been used to identify bacterial antibiotic resistance genes, including β -lactamases, carbapenemases, and the *mecA* gene of MRSA. For the detection of pathogens, several approaches are under investigation, including the specific high-sensitivity enzymatic reporter unlocking (SHERLOCK) test. In this method, Cas13 is programmed with crRNA to target the ssRNA of interest, and a quenched fluorescent ssRNA reporter is added to the reaction. The crRNA-Cas13 complex binds and cleaves the nucleic acid target. When the crRNA-Cas13 complex binds to the target, the quenched fluorescent reporter RNA is also cleaved by Cas13 and a fluorescent signal is emitted. The sensitivity of this assay can be enhanced by first amplifying the RNA using a reverse transcriptase recombinase polymerase amplification (RPA). Amplification of DNA and conversion to RNA can be performed by using RPA coupled with T7 transcription. An adaptation of SHERLOCK does not use fluorescence, and the reporter can be detected in lateral flow strips. With SHERLOCKv2, using different Cas proteins, quantitative results can be obtained. In the DNA endonuclease-targeted CRISPR *trans* reporter (DETECTR) method, the Cas12a is targeted to a specific DNA sequence via the crRNA. Hybridization of the crRNA-Cas12a complex to the target DNA leads to random cleavage of *trans*-ssDNA, including an ssDNA fluorescent quencher reporter that is degraded, and the fluorescence is quantified. To increase sensitivity, the

DNA target can be first amplified through an isothermal amplification by RPA.

Another molecular detection method that has moved from the research laboratory to the clinical microbiology laboratory is mass spectrometry. In the 19th century, physical and chemical characterization of the nature of matter laid the groundwork for the implementation of mass spectrometry. In 1918, Arthur J. Dempster established the basic theory and design of mass spectrometers, and Francis W. Aston built the first functional mass spectrometer in 1919. Working with isotopes of bromine, chlorine, and krypton, Aston was able to show that these naturally occurring elements are composed of various isotopes. Rapid advances have occurred since then, including the invention of the cyclotron by Ernest Lawrence, the concept of a time-of-flight mass spectrometer by William E. Stephens, the development of electrospray ionization by John B. Fenn and Malcolm Dole, and the ultra-fine metal plus liquid matrix method developed by Koichi Tanaka to ionize intact proteins. With all these advances, mass spectrometry, once used mainly in the research laboratory, is now becoming part of standard identification protocols in the clinical laboratory.

Other than the initial costs of the instrumentation, matrix-assisted laser desorption ionization-time of flight mass spectrometry (MALDI-TOF MS) offers significant advantages over standard automated identification methods. Speed of identification is probably the most significant advantage of MALDI-TOF MS: bacterial identification can be shortened on average by a day and a half compared with standard methods. Another benefit of MALDI-TOF MS is that a single colony can directly be used for identification, and therefore, most of the time, isolates from a primary culture plate can be utilized. Costs per isolate identification are also significantly lower with MALDI-TOF MS than with standard methods. Based on several studies, 98% and 96% of aerobic bacteria can be identified at the genus and species levels, respectively, by MALDI-TOF MS. For anaerobic bacteria, the percentages are slightly lower, 90% and 85%. As more isolates are added to the databases, these percentages will continue to increase.

Identification of *Mycobacteria* and *Nocardia* species is more challenging. Approximately 90% of *Mycobacterium* and *Nocardia* species can be identified. For safety, mycobacteria need to be killed, and for analysis, aggregated cells must be disrupted and the envelopes broken down. With the current

databases, *M. tuberculosis* complex can be identified only at the complex level, and some species are difficult to differentiate from each other. Approximately 12 *Nocardia* species can be identified using the current databases.

The use of MALDI-TOF MS for rapid detection of antimicrobial resistance is in the very early stages of development. Three major approaches are under investigation. The first is detection of antibiotic modifications as a result of the enzymatic activity of bacteria. Major advances have been made using this approach, for example, by measuring changes in the mass of the antibiotic indicative of β -lactamase activity. Another method is detection of antimicrobial resistance by analyzing the mass peak profiles of susceptible and resistant bacteria. Expression of a specific protein involved in a resistance phenotype, as indicated by changes in the mass peak profile, may help differentiate susceptible and resistant isolates. The presence of carbapenemase in *Bacteroides fragilis* isolates containing the *cfiA* gene has been detected using this approach. Third, measuring protein synthesis can be used to determine resistance. The drawback of this approach is that the isolate must be grown in the presence and absence of the antibiotic for approximately 3 h before MALDI-TOF MS testing is performed. This method has allowed differentiation between methicillin-susceptible and methicillin-resistant *Staphylococcus aureus* isolates.

Implementation of all these new molecular methods, however, would not have been possible if not for advances in other fields, in particular computer and mechanical engineering sciences. The handling of massive amounts of sequencing data is possible because of the development and implementation of computational analysis. Charles Babbage, a mathematician and mechanical engineer, is credited with originating the concept of a programmable computer in the 1800s. In the early 1900s, Alan Turing established the groundwork for computer science and artificial intelligence, and the Turing machine is considered the blueprint for the electronic digital computer. In 1941, Konrad Zuse constructed the first working, programmable, fully automatic computing machine. In the past 40 years, the development of software and hardware that are both easy to use and relatively low in cost has made

the use of computers accessible not only to the scientific community but also to the public at large. Similarly, advances in mechanical engineering have resulted in the miniaturization of components and the application of robotics, thus facilitating the construction of instruments that can perform highly complex processing of clinical specimens at very high speed and at reasonable cost.

While it may take years, if not decades, to incorporate these new methods fully, they have the potential to significantly improve the management of patients with infectious diseases. Implementation of these methods will also require the reevaluation of how we diagnose and manage patients. From the point of view of specificity, techniques such as DNA sequencing probably provide as much information as we will ever need. The sensitivity of these methods, though, is going to require further work for at least some bacterial infections. For example, the very low number of organisms present in most cases of septicemia is still a challenge for our current molecular methods. The volume of the sample that can be collected and processed and the presence of inhibitory substances can also contribute to the limited sensitivity of these assays.

Interpretation of some of these results will also be a challenge. An increase in the analytical sensitivity of molecular methods cannot necessarily be directly applied to evaluate their clinical sensitivity. For example, some pathogens are present in low numbers as part of the normal microbiome. Quantitative molecular techniques may help to address this problem, but it will require extensive studies. In addition, the fact that these methods detect nucleic acids, and not necessarily viable organisms, necessitates further evaluation. This issue was extensively debated when molecular methods were implemented for the detection of *Chlamydia trachomatis* and *Neisseria gonorrhoeae*. This concern has now been incorporated into the management of patients. For example, it is not recommended to use nucleic acid amplification techniques as a test of cure to assess the efficacy of antibiotic therapy for a period of time following completion of the treatment. In the future, simultaneous evaluation of host molecular markers in response to infection may also help address the limitations of these new diagnostic techniques.

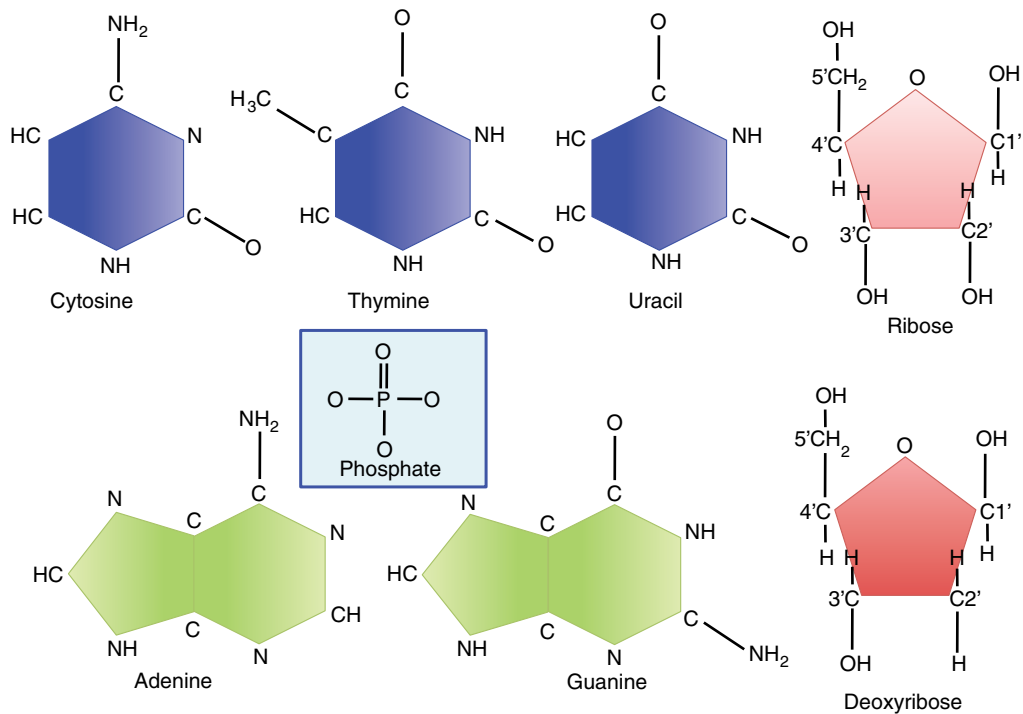


Figure 39-1 The building blocks of DNA and RNA. The building blocks of DNA and RNA are sugars, phosphate, and bases. The two main types of nucleic acids (DNA and RNA) differ in the type of sugar: the five-carbon sugar in DNA is deoxyribose, whereas that in RNA is ribose. The four nitrogen-containing bases in DNA are adenine (A), guanine (G), cytosine (C), and thymine (T), while in RNA the thymine is replaced by uracil (U). Cytosine, thymine, and uracil are pyrimidines, while adenine and guanine are purines. The number of each carbon on a sugar is followed by a prime symbol (for example, the 3' carbon).

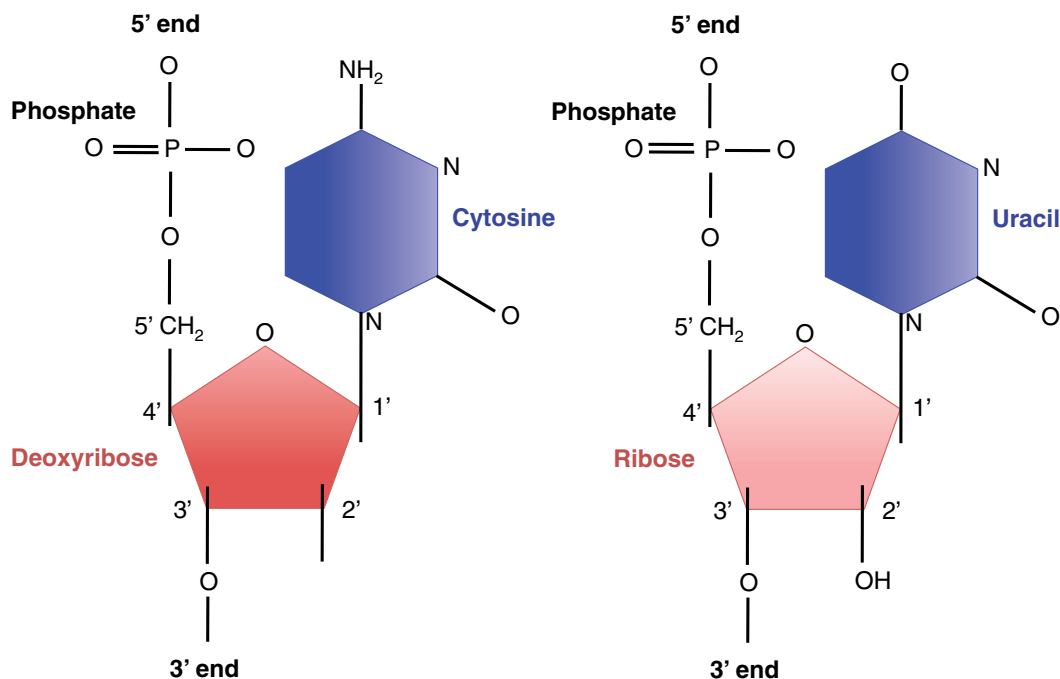


Figure 39-2 Nucleotides. DNA and RNA are polymers. The basic units of the polymer are nucleotides, which consist of a base, a sugar, and one or more phosphate groups. A nucleoside is only a base plus a sugar. Nucleotides are linked to each other by a phosphodiester linkage between carbon atoms of the sugar, known as the 5' and 3' atoms. As a result, the 5' end of the polynucleotide chain has a free phosphate group, while the 3' end has a free hydroxyl group. The phosphates are joined to the C-5 hydroxyl of the ribose, or the deoxyribose, while the bases are linked to the C-1 of the sugar by an N-glycosidic bond. The nucleotides of DNA, since they contain the sugar deoxyribose, are called deoxyribonucleotides, while those of RNA, which contain ribose, are called ribonucleotides.

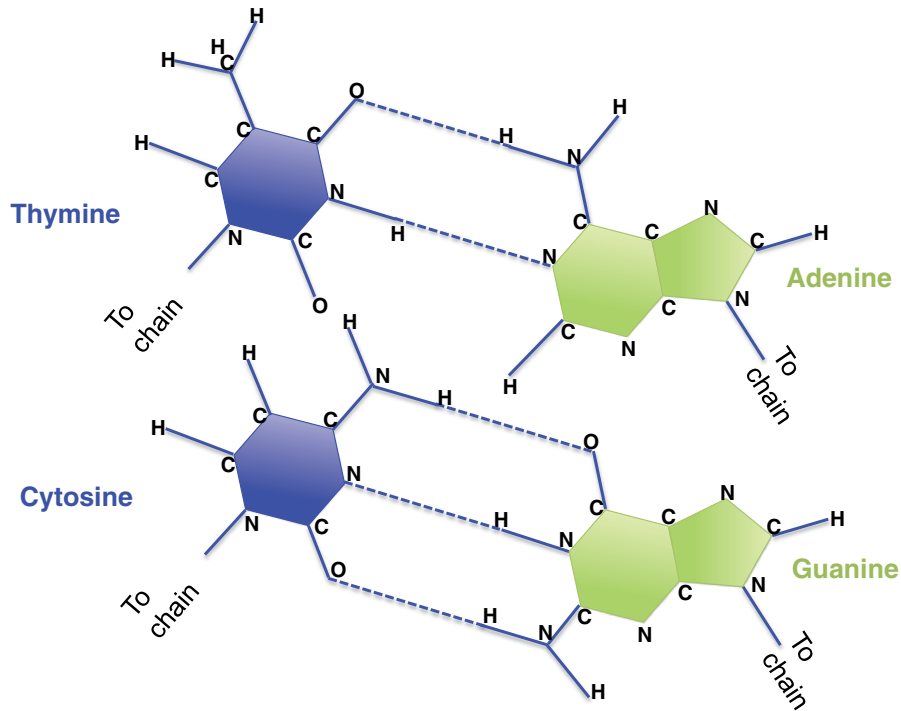


Figure 39-3 Hydrogen bonds. Pairs of bases, A-T and G-C, are linked by hydrogen bonds. There are two hydrogen bonds between A and T and three hydrogen bonds between G and C. Therefore, the G-C bond is more difficult (requires more energy) to break than the A-T bond. In this type of bond, the hydrogen is located between two electron-attracting atoms, such as nitrogen and oxygen. When dsDNA is denatured, for example by heat or an alkaline pH, the hydrogen bonds between the bases break. Molecules that form hydrogen bonds to each other can form hydrogen bonds to water molecules.

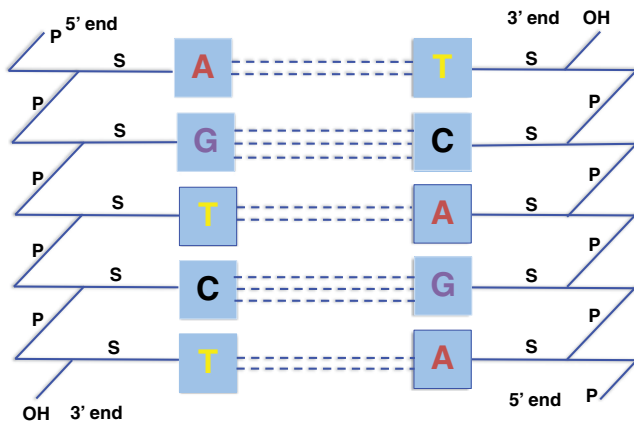


Figure 39-4 Double-stranded DNA. dsDNA is composed of two long polynucleotide chains that are complementary to each other; that is, their base sequences match (A with T and G with C). The structure of a dsDNA molecule resembles a ladder. The sugar (S) and phosphate (P), known as the backbone of the molecule, form the rails of the ladder, while the bases correspond to the rungs. The two chains have different polarities and run antiparallel to each other. As a result, a dsDNA molecule has a deoxyribose at the 3' end and a phosphate at the 5' end. The linear sequence in a polynucleotide chain is always read starting from the 5' end.

Figure 39-5 DNA-DNA and DNA-RNA hybridization. When a dsDNA molecule is denatured with heat, the two ssDNA molecules are not necessarily irreversibly separated. If a heated DNA solution is allowed to cool down slowly, an ssDNA may be able to reassociate with its complementary strand and reform the original dsDNA molecule. Similarly, if a complementary RNA sequence is added, a hybrid DNA-RNA molecule will be formed. Among the factors that affect the degree of specificity of the reassociation reaction, temperature, salt concentration, and the pH are very important. The stringency of the hybridization reaction can be restricted with those parameters, and therefore, the degree of mismatched bases along the strands can be controlled. In the process shown here, the dsDNA from two unrelated organisms was extracted, sheared by sonication to make fragments 500 to 1,000 bp in length, and heated. The amount of heat required to dissociate the fragments of dsDNA is mainly dependent on the number of G-C base pairs present in each dsDNA fragment. The higher the number of G-C pairs, the higher the temperature. The melting temperature of the dsDNA can be used to determine its base composition and is frequently utilized to verify the specificity of the amplified product of a nucleic acid amplification reaction. For this illustration, it is assumed that there is no sequence homology between the DNA of the two organisms, so that upon reassociation the two genomes are independently reassociated.

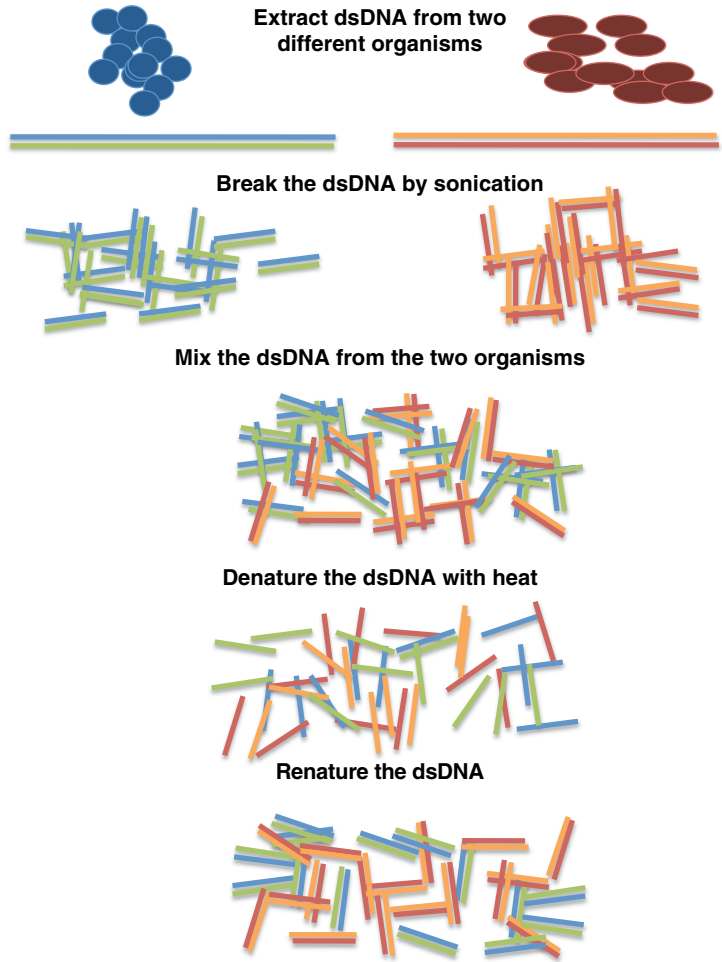
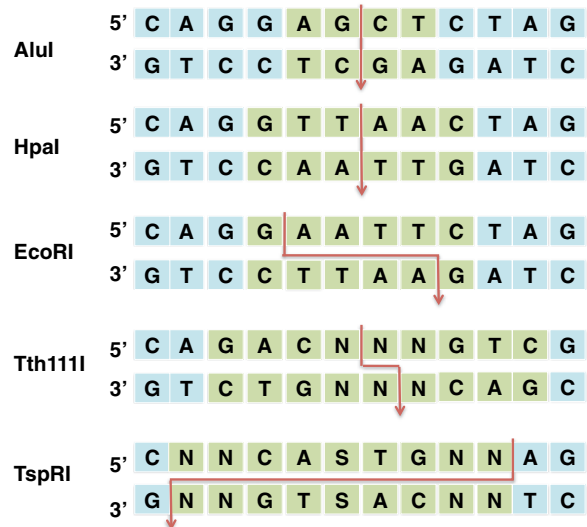


Figure 39-6 Restriction endonucleases. Restriction endonucleases are bacterial enzymes that cleave the phosphodiester bond of DNA at specific sequences known as restriction sites. These sites are usually 4 to 8 bp in length and frequently have a palindromic structure, meaning that the sequence on one strand is identical to that of the complementary strand when read in the same orientation (e.g., 5' to 3'). Assuming a random DNA sequence, there is an inverse relationship between the length of the recognition DNA sequence as cut by the enzyme and its frequency of occurrence. These enzymes are usually named after the bacterial species from which they were isolated. For example, as shown here, EcoRI was isolated from *Escherichia coli*, while HpaI was extracted from *Haemophilus parainfluenzae*. Restriction enzymes usually cut the DNA within the recognition sequence, although some of them cut at a nearby position. Enzymes that cut the same DNA sequence are called isoschizomers. Some of these enzymes, although they recognize the same sequence, may be affected differently by methylation. These enzymes make it possible to determine whether a segment of DNA is or is not methylated by comparing the fragments produced by cleaving the DNA with a methylation-sensitive and a methylation-insensitive isoschizomer. Abbreviations: S = C or G; N = A or T or C or G.



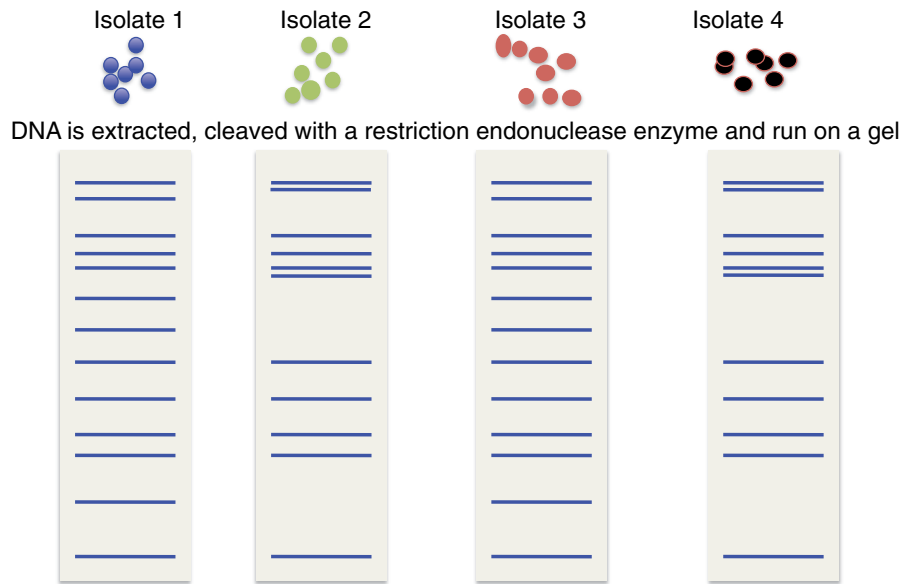


Figure 39-7 Restriction fragment length polymorphism analysis. In restriction fragment length polymorphism (RFLP) analysis, DNA is digested with restriction endonucleases and the cleaved products are separated by gel electrophoresis. When DNA is cleaved with a restriction enzyme, several fragments are generated. The number and size of the fragments are a result of the distance between restriction sites in the DNA. Closely spaced restriction sites result in short DNA fragments, while those located greater distances apart yield long DNA fragments. Assuming that the bases in a particular DNA fragment are randomly distributed, we expect that a restriction enzyme that recognizes 4-bp sequences will generate more fragments than one that recognizes 8-bp sequences. The DNA fragments generated by the restriction endonucleases can be separated by electrophoresis in agarose or polyacrylamide gels. Because of the ionized phosphate groups at a mild alkaline pH, the DNA is negatively charged and migrates towards the anode. Small DNA fragments migrate faster than large segments. After electrophoresis, the DNA can be visualized in the gel by using fluorescent dyes. The DNA bands can be stained with ethidium bromide, and the cleavage pattern of different bacterial isolates can be compared. RFLP analysis was one of the first techniques extensively used for genetic fingerprinting of pathogenic isolates. Based on the results shown here, we can say that isolate 1 is closely related to isolate 3 and isolate 2 is related to isolate 4.

Pulse field gel electrophoresis

Control 1 Isolate 1 Isolate 2 Isolate 3 Isolate 4 Isolate 5 Isolate 6 Isolate 7 Isolate 8 Control 2



DNA is extracted, run on an agarose gel and stained with ethidium bromide

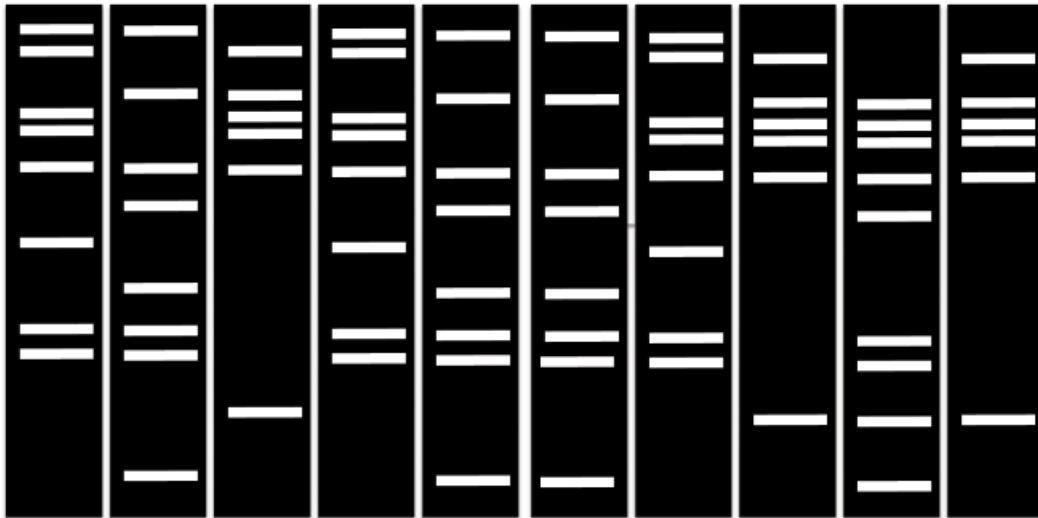


Figure 39-8 Pulsed-field gel electrophoresis. Pulsed-field gel electrophoresis (PFGE) is used for genotyping prokaryotes, and it was the gold standard for epidemiological studies until DNA sequencing became readily available. Large DNA fragments, 20 kb to >1 Mb, are separated by gel electrophoresis utilizing pulsed electrical fields. These large fragments are usually generated by digesting the DNA with rarely cutting restriction endonucleases, in general enzymes that recognize eight or more nucleotide bases. This technique is used because DNA fragments larger than 30 to 50 kb run at the same rate in standard gel electrophoresis. In contrast to the standard gel electrophoresis method, in which the voltage is constantly running in one direction, for PFGE the voltage is periodically switched among three directions. One direction is the central axis of the gel, and the other two are at a 60° angle on either side. This periodic change in field direction allows various lengths of DNA to change at different rates. Larger fragments of DNA will realign more slowly than smaller pieces when the field direction is changed. The separated fragments can be visualized, for example, by using ethidium bromide. This figure shows that control 1 is related to isolates 3 and 6 while control 2 is related to isolates 2 and 7.

DNA is extracted from organism and cleaved with restriction endonucleases

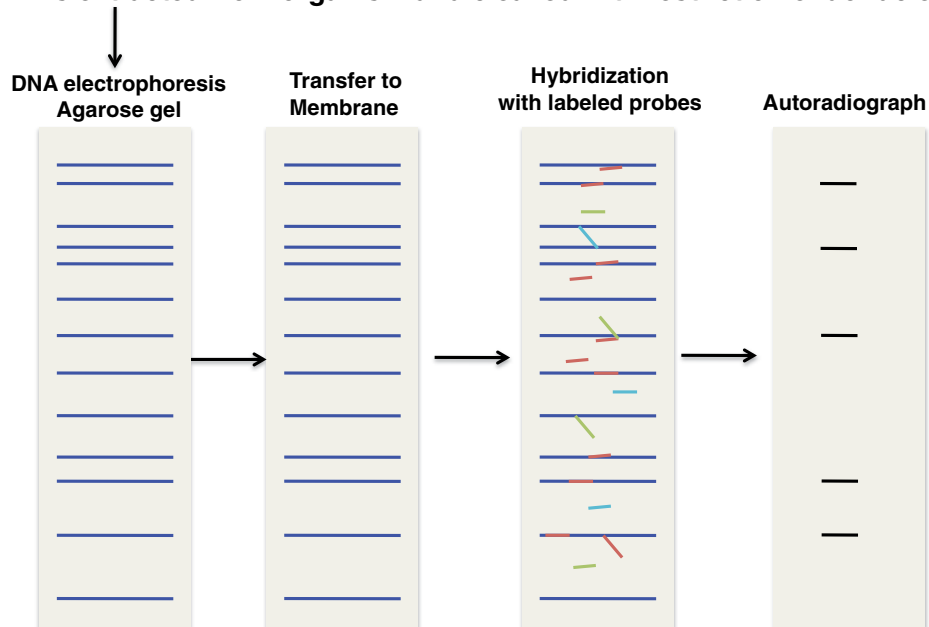


Figure 39-9 Southern blotting. For Southern blots, since gels are fragile, after electrophoresis of the restriction endonuclease-digested fragments, the DNA is transferred (blotted) to a positively charged membrane, usually nitrocellulose or nylon, where the DNA binds. To make the transfer, the DNA is treated with alkali, which results in the formation of ssDNA. To identify specific fragments on the membrane, the Southern blot uses labeled ssDNA probes unique to the regions of interest. The probe hybridizes to the complementary sequence blotted on the membrane. Factors that significantly affect the specificity of the binding include the salt concentration of the buffer and the temperature. This technique can be used to test for mutations, deletions, and the presence of specific gene sequences, among others.

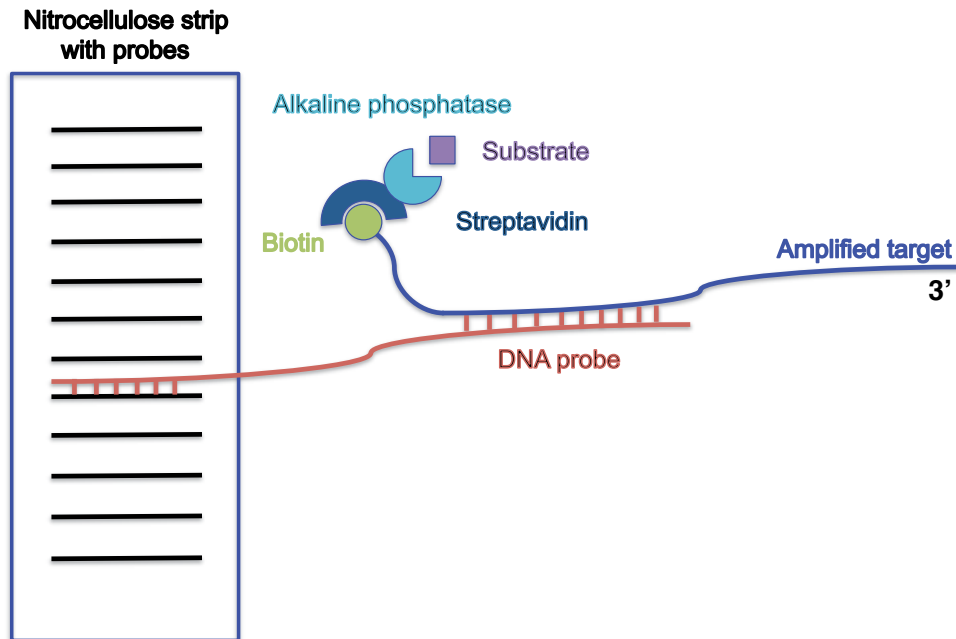


Figure 39-10 Line probe assays. In line probe assays (Immunogenetics, Ghent, Belgium), oligonucleotides specific for the target of interest are attached to nitrocellulose strips. The biotin-labeled amplified target nucleic acid to be identified is hybridized to the immobilized probes on the nitrocellulose membrane. Following hybridization, streptavidin-labeled probes with alkaline phosphatase are added and incubated to bind to the hybrids. Addition of a chromogen results in the production of a color precipitate. DNA probes that hybridize to rRNA are frequently utilized to detect bacteria. The number of copies of rRNA present per bacterial cell is at least 10,000, and therefore, it is a good target for detection. This assay has been used for the identification of *M. tuberculosis*, for analysis of drug resistance in *M. tuberculosis* and *Helicobacter pylori*, and for the genotyping of several viruses.

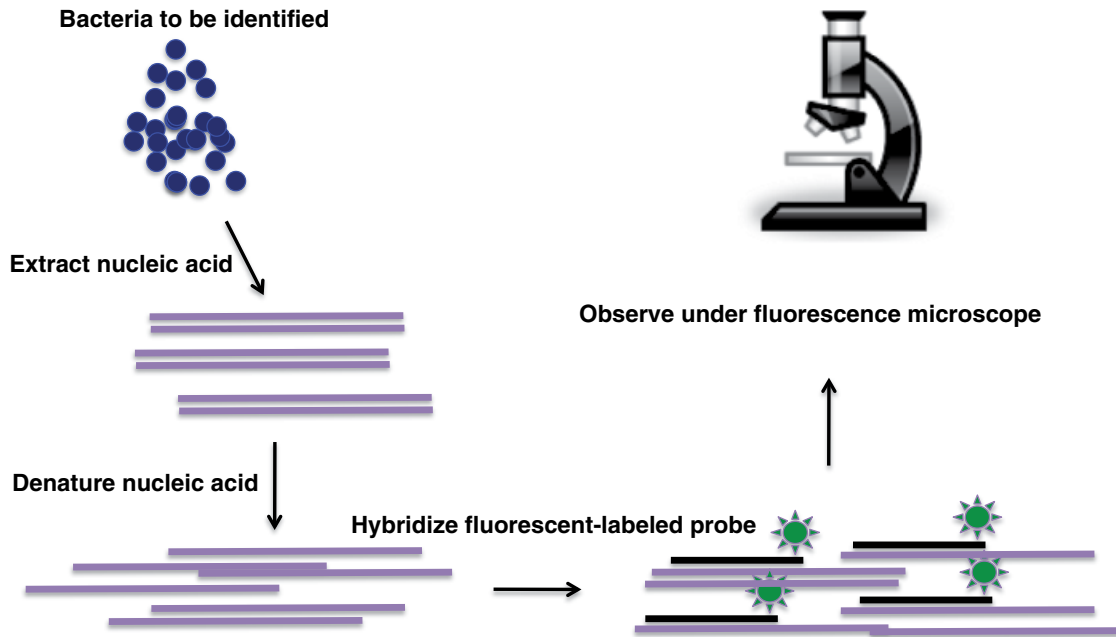


Figure 39-11 Fluorescent *in situ* hybridization. Fluorescent *in situ* hybridization is a method in which a fluorescence-labeled probe is hybridized to the target nucleic acid. The probes either can be directly labeled (direct technique) or have a hapten, such as biotin or digoxigenin, that can be detected by a fluorescently labeled conjugate (indirect technique). The direct technique is shown here. This assay is used in cases of bloodstream infections to discriminate between *S. aureus* and coagulase-negative staphylococci and also to differentiate *Candida albicans* from other *Candida* species.

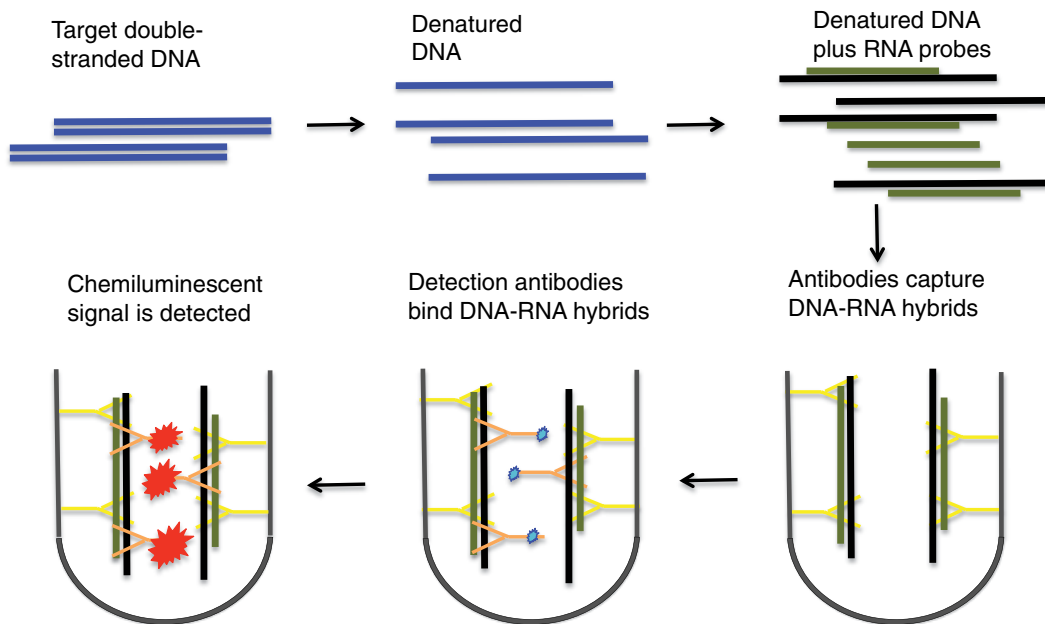


Figure 39-12 Hybrid capture assay. In the hybrid capture assay (Qiagen, Germantown, MD), the target DNA is denatured and then hybridized to a cRNA probe. Antibodies bound to a solid phase, specific for the DNA-RNA hybrid, capture this complex. Alkaline phosphatase-conjugated anti-RNA-DNA hybrid antibodies are subsequently added. The bound antibody conjugate is detected by using a chemiluminescent substrate, and the light is measured in a luminometer. Hybrid capture assays are available for the detection of *N. gonorrhoeae*, *C. trachomatis*, and several viruses.

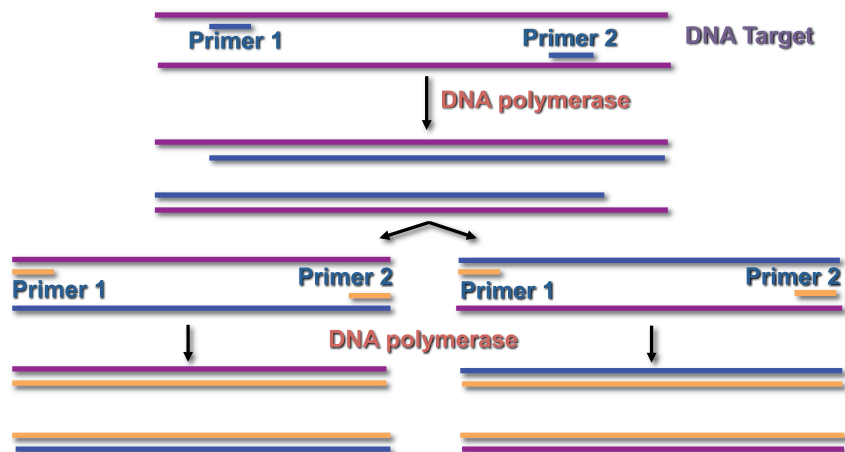


Figure 39-13 PCR. In PCR amplification, in addition to the target dsDNA, two oligonucleotides (primers), a heat-stable DNA polymerase, and the four dNTPs are added in a buffer solution. The two primers are complementary to opposite strands of the target and are usually at a distance of 100 to 500 bp from each other. The reaction starts by increasing the temperature to approximately 95°C to denature the target dsDNA. This is followed by cooling to approximately 60 to 65°C to allow the primers to anneal to the target DNA. The DNA polymerase then initiates the extension of the primers, producing new dsDNA copies. Under ideal conditions, the number of target sequences doubles each cycle. In a 100% efficient reaction, a 10^6 -fold amplification occurs after 20 cycles and a 10^9 -fold amplification is obtained after 30 cycles. The amplified DNA can be detected by various methods, including the use of fluorescent dyes, such as ethidium bromide, after running a gel or by using labeled oligonucleotides complementary to the amplified target. Internal controls can be included in the reaction mixture to make sure that no inhibitory substances such as hemoglobin interfered with the amplification. Numerous commercial kits are available for the detection of pathogens using PCR.

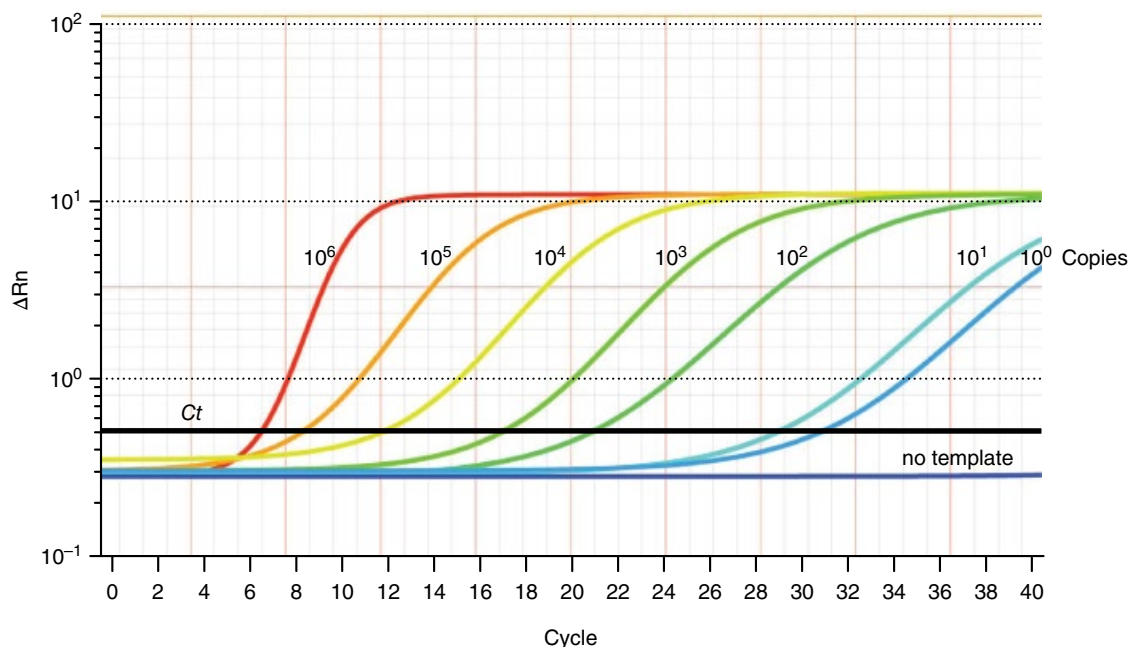


Figure 39-14 Real-time PCR. In this type of PCR, amplification of the target and detection of the amplified product occur simultaneously. Using different dyes, fluorescence emission is generated proportional to the amount of the amplified product. This image shows the normalized fluorescence signal from the reporter dye depending on the initial input of target sequences. The cycle threshold (C_T) is the cycle number at which fluorescence passes the fixed threshold. The number of copies in the sample is calculated by determining the C_T and using a standard curve to determine the starting number of nucleic acid copies. Several commercially available kits are available for the detection of a wide variety of bacterial pathogens, including *M. tuberculosis*, *C. difficile*, *C. trachomatis*, *N. gonorrhoeae*, *S. aureus*, and *Streptococcus agalactiae*.

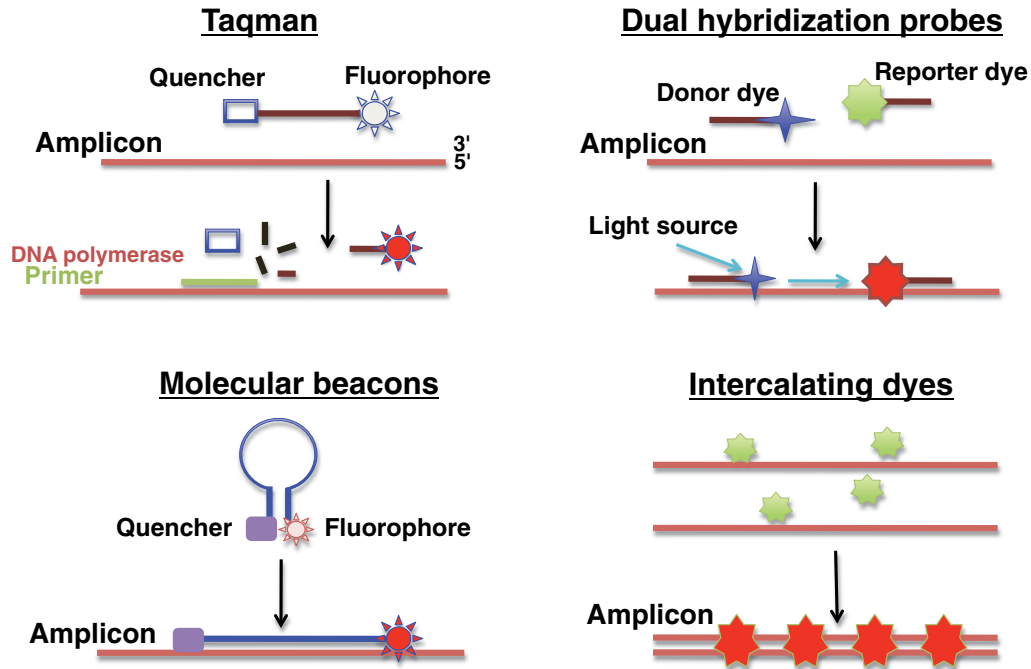


Figure 39-15 Molecular probes. Different approaches can be used to detect the product of an amplification reaction in real time. Dyes such as SYBR Green I intercalate into dsDNA and can therefore be used to determine the amount of dsDNA produced during nucleic amplification reactions. Fluorescence resonance energy transfer probes are labeled with a fluorescent dye and a quencher. The distance in the probe between the dye and the quencher is such that the fluorescence of the dye is absorbed by the quencher. In the case of the TaqMan method, the probe hybridizes to the target DNA, and when the exonuclease activity of the *Taq* DNA polymerase digests the probe, the fluorescent dye is released. Alternatively, as also shown here, dual hybridization probes have the dye and the quencher in different oligonucleotides which come into proximity only after they both anneal to the amplified target DNA.

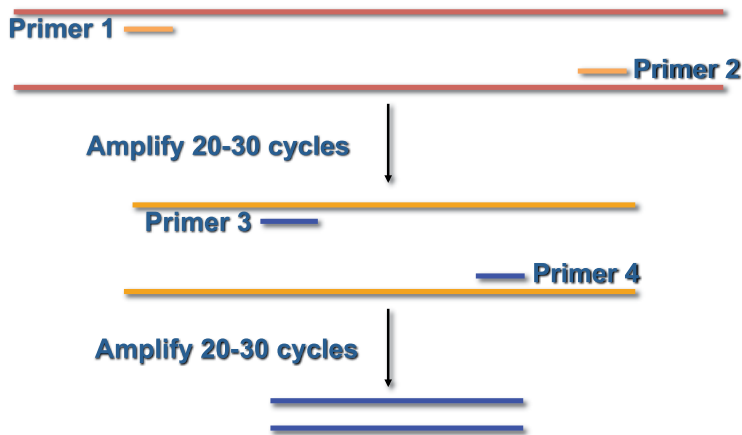


Figure 39-16 Nested PCR. Nested PCR uses two sets of primers. Following amplification with the first set of primers, a second set of oligonucleotides, complementary to the sequence that was amplified during the first round, is added and the amplification continues. The main purpose of the nested PCR is to increase the sensitivity of the assay. Problems of contamination due to carryover are difficult to avoid with this method unless it is carried out in a completely closed system.

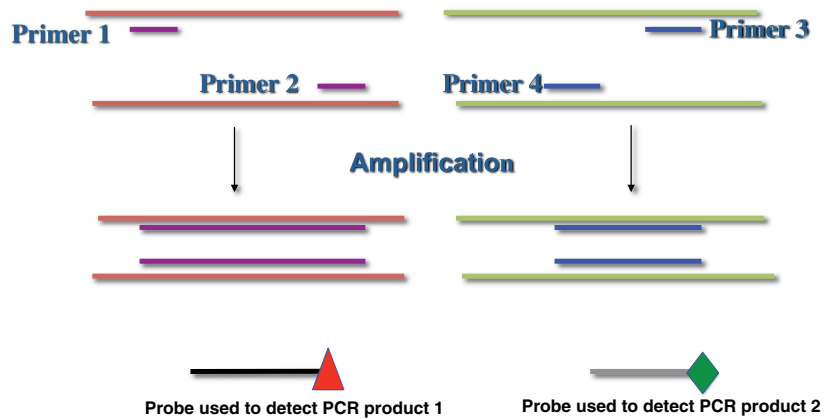


Figure 39-17 Multiplex PCR. The purpose of multiplex PCR is to amplify different targets in the same reaction. The primers selected must have similar annealing temperatures and must not be complementary to each other. Following amplification, the products of each set of primers can be detected by using probes specific for each amplified product. The commercial molecular panels available are designed to aid in the diagnosis of bloodstream, upper and lower respiratory tract, gastrointestinal, and central nervous system infections. Several companies have kits for the detection of multiple bacterial, viral, and parasitic pathogens, including BioFire (Salt Lake City, UT), Hologic Prodesse (San Diego, CA), Luminex Corp. (Austin, TX), GenMark Diagnostics (Carlsbad, CA), and T2 Biosystems (Lexington, MA).

Reverse transcriptase PCR

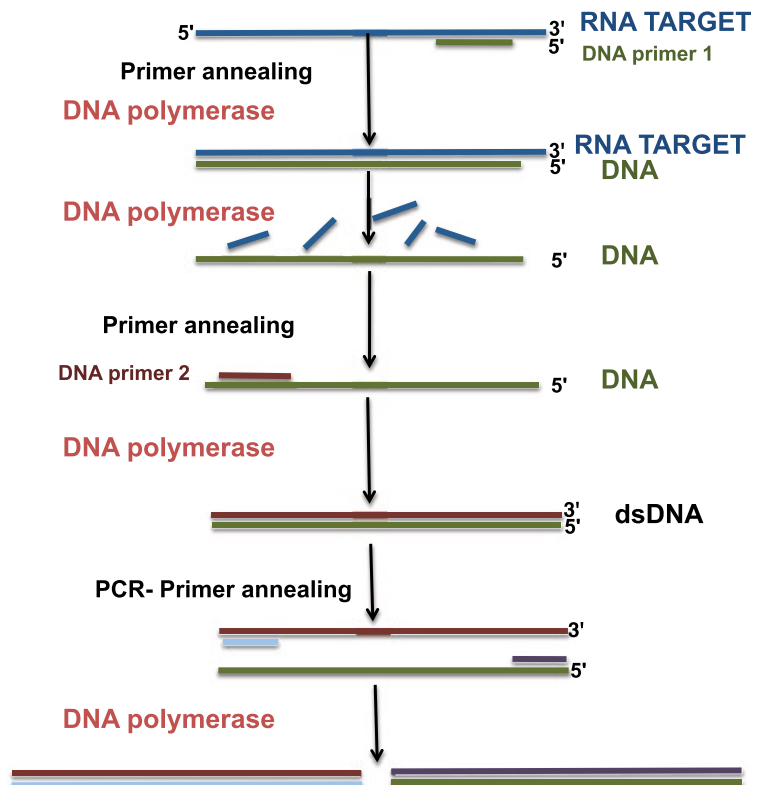


Figure 39-18 Reverse transcriptase PCR. Most of the work originally performed with PCR involved the amplification of DNA. To amplify RNA, a reverse transcription step was incorporated to produce cDNA to the target RNA. The use of a thermostable DNA polymerase that, under the appropriate conditions, has both reverse transcriptase and DNA polymerase activity permits the complete reaction to occur using a single enzyme.

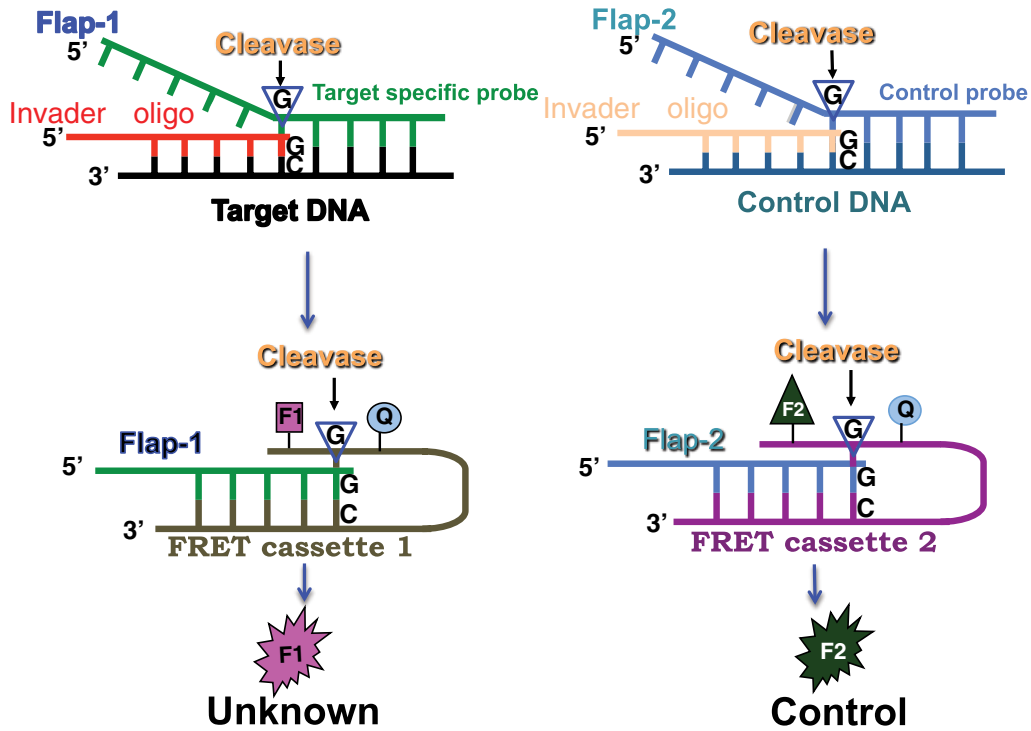


Figure 39-19 Cervista molecular assay. The Cervista (Hologic, Bedford, MA) method uses Invader chemistry, a signal amplification method, for the detection of specific nucleic acid sequences. Two isothermal reactions, a primary reaction directed to the target DNA and a secondary reaction that generates a fluorescent signal, occur simultaneously. In the primary reaction the probe and the Invader oligonucleotide bind to the DNA target. When this oligonucleotide overlaps by at least 1 bp with the target DNA, an invasive structure forms that serves as the substrate for the Cleavase enzyme. The cleaved flap then binds to the hairpin fluorescence resonance energy transfer (FRET) oligonucleotide, forming another invasive structure that the Cleavase also cuts. This separates the fluorophore from the quencher, producing the fluorescence signal. The probes are added in large molar excess, and they cycle rapidly, resulting in a 10^6 - to 10^7 -fold signal amplification per hour. When human specimens are tested, a positive internal control, the human histone 2 gene, is also present and is detected with different primary and secondary probes. This internal control helps to confirm that negative results are not due to insufficient sample or inhibitory substances, and to ensure that the testing procedure was performed correctly.

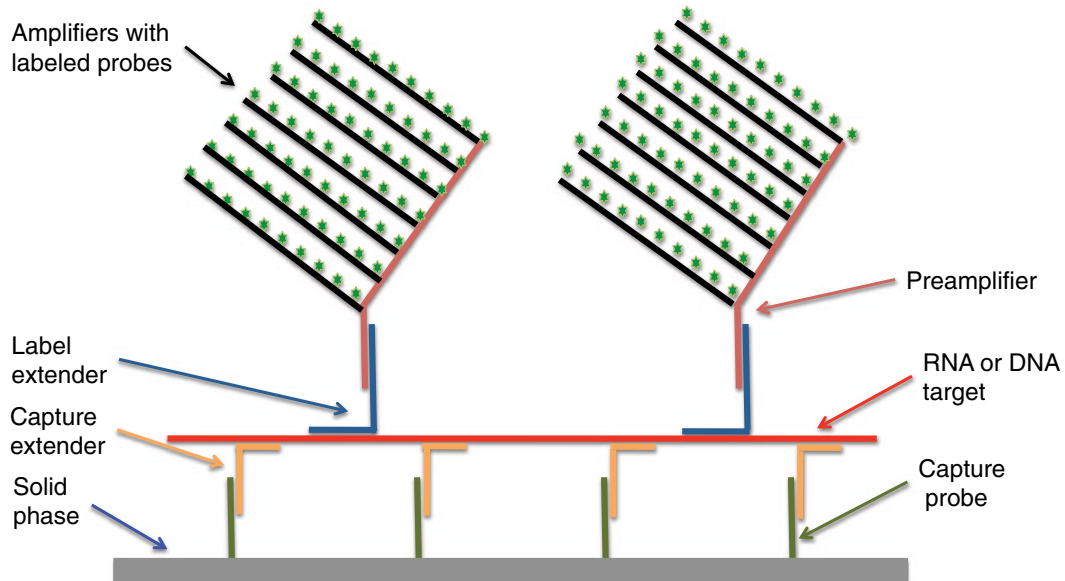


Figure 39-20 Branched DNA. Branched DNA (Siemens Healthcare Diagnostics, Deerfield, IL) is a signal amplification sandwich hybridization system that incorporates the addition of multiple synthetic oligonucleotide probes. As shown here, capture probes attached to a solid phase, such as a microtiter plate, bind to capture extenders that are also complementary to the DNA or RNA target of interest. Label extender probes, also complementary to the DNA or RNA target, are then added. Preamplifier molecules subsequently bind to the label extender probes and to amplifiers. Alkaline phosphatase-labeled probes hybridize to the amplifiers. When dioxetane is added, the light emission produced is measured by a luminometer. The amount of signal is proportional to the quantity of the target in the sample, and the number of target copies is calculated by using an external standard curve. So far, this method has been used for the identification and quantitation of viruses.

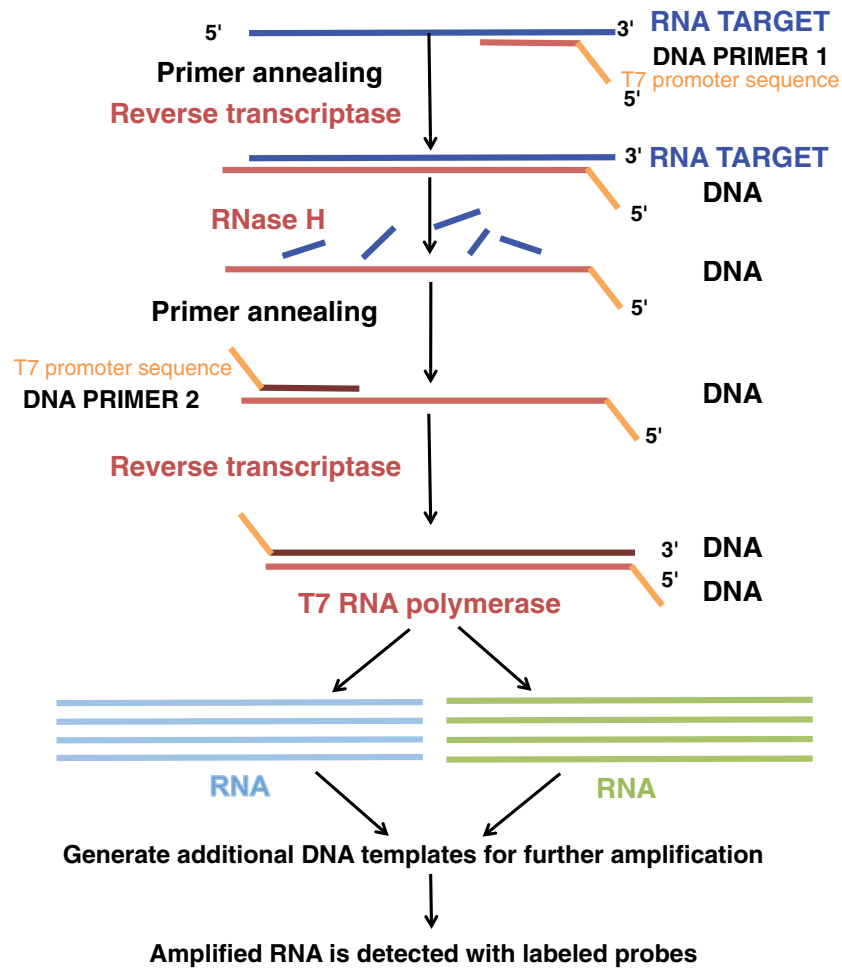


Figure 39-21 Transcription-based amplification. Transcription-based amplification (Hologic Inc., San Diego, CA) and nucleic acid sequence-based amplification are isothermal methods that amplify RNA targets using retroviral replication as the model. A DNA primer, containing sequences complementary to the target RNA and the T7 RNA polymerase promoter, is hybridized to the target RNA. The reverse transcriptase synthesizes cDNA. The RNase H enzyme then degrades the target RNA of the RNA-DNA hybrid. A second primer binds to the cDNA, and the DNA polymerase activity of the reverse transcriptase extends the primer, resulting in the formation of a dsDNA containing the T₇ RNA polymerase promoter at both ends. Using the cDNA as template, the T₇ RNA polymerase synthesizes multiple copies of ssRNA that reenter the cycle. The RNA products of the reaction can be detected and quantitated by using oligonucleotide probes. Alternatively, the amplification products can be measured using real-time methods. These assays are commercially available for *M. tuberculosis*, *Mycoplasma genitalium*, *C. trachomatis*, *N. gonorrhoeae*, and other bacterial and viral pathogens.

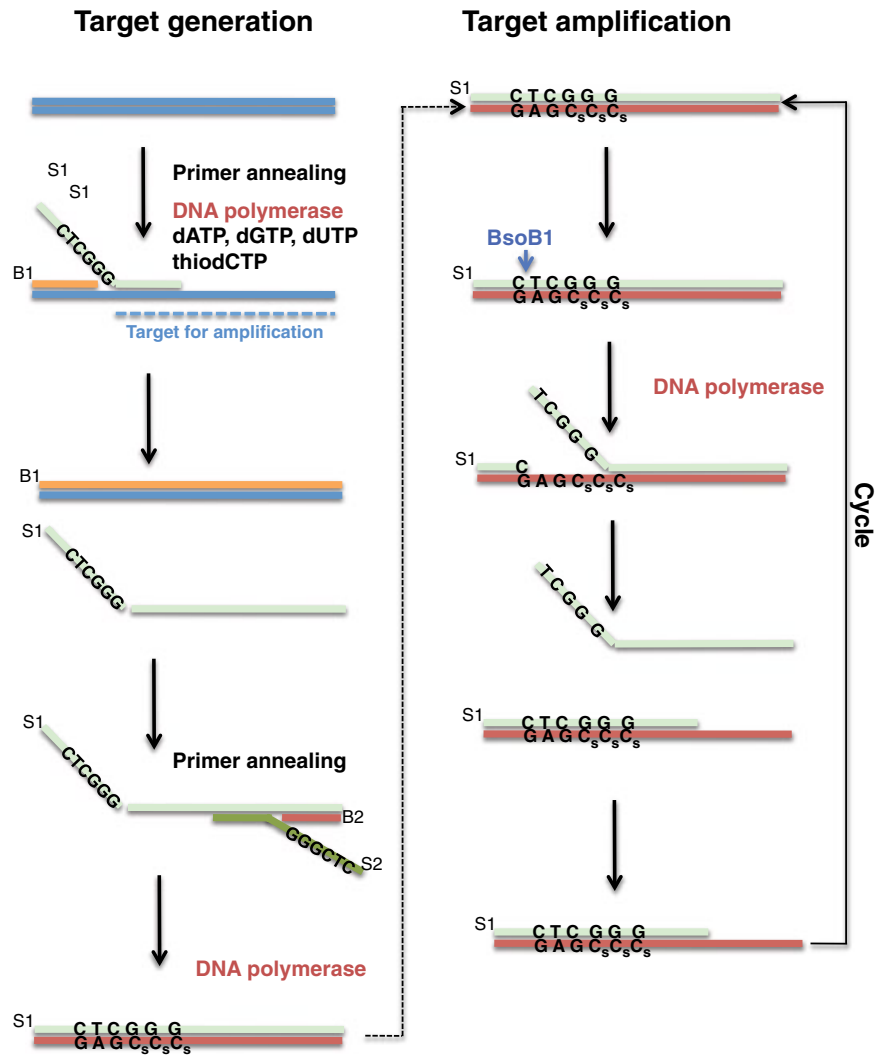


Figure 39-22 Strand displacement amplification. Strand displacement amplification (BD Diagnostic Systems, Franklin Lakes, NJ) is an isothermal method that can be used to amplify DNA or RNA. As shown here, dsDNA is denatured and hybridized to two different oligonucleotides, called bumper and amplification primers. The amplification primer includes the single-stranded restriction endonuclease sequence of BsoBI at the 5' end. The bumper primer anneals to the target DNA upstream from the segment to be amplified. Three standard deoxynucleotide triphosphates, dATP, dGTP, and dUTP, in addition to a thiolated dCTP (C_s), are added. Simultaneous extension of both primers results in the displacement of the amplification primer, which can then hybridize with the opposite strand. The BsoBI enzyme binds to the amplified products and, due to the C_s, only nicks the strand rather than cleaving it. The DNA polymerase binds to the nicked site and synthesizes a new strand while simultaneously displacing the downstream strand, thus generating dsDNA with the same structural characteristics, which reenters the cycle. Labeled probes can be used to detect the amplified products by using a real-time method. The image shows amplification for only one strand, but both strands of the dsDNA are amplified simultaneously. Commercially available kits are available for the detection of *C. trachomatis* and *N. gonorrhoeae* using this approach.

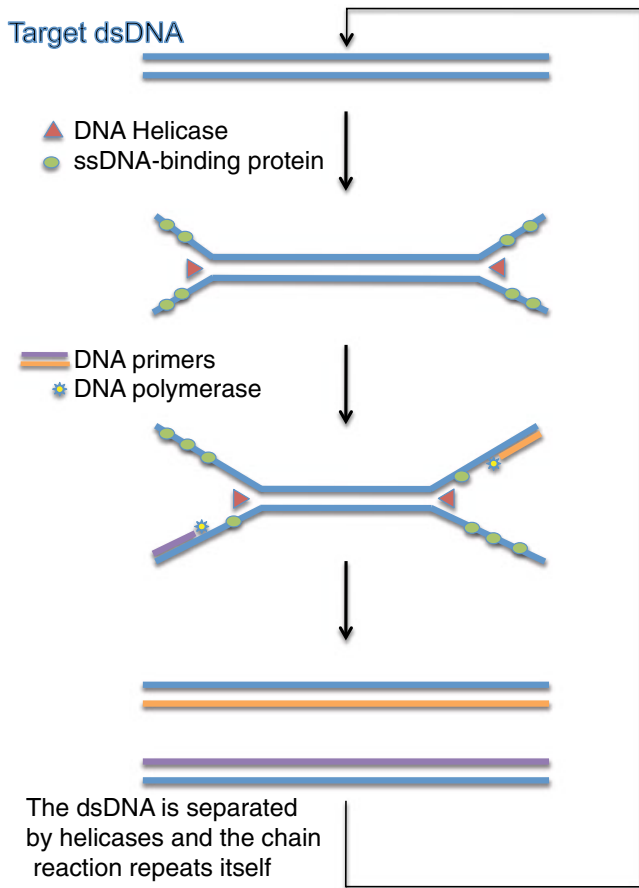


Figure 39-23 Helicase-dependent amplification. In helicase-dependent amplification, an isothermal amplification method (Quidel, Beverly, MA), the dsDNA is separated by two enzymes, helicase and the ssDNA-coated ssDNA-binding protein, resulting in two ssDNA templates. These two enzymes, therefore, replace the increase in temperature that is used in a standard PCR to separate the two DNA strands. Specific primers are added, and a DNA polymerase extends the strands. The newly synthesized products continue to cycle and can be detected with a variety of probes. Assays to detect *C. trachomatis*, *N. gonorrhoeae*, *H. pylori*, *Bordetella pertussis*, and other pathogens, as well as *C. difficile* toxin A, are available. (Adapted from Vincent et al., *EMBO Rep* 5:793–800, 2004.)

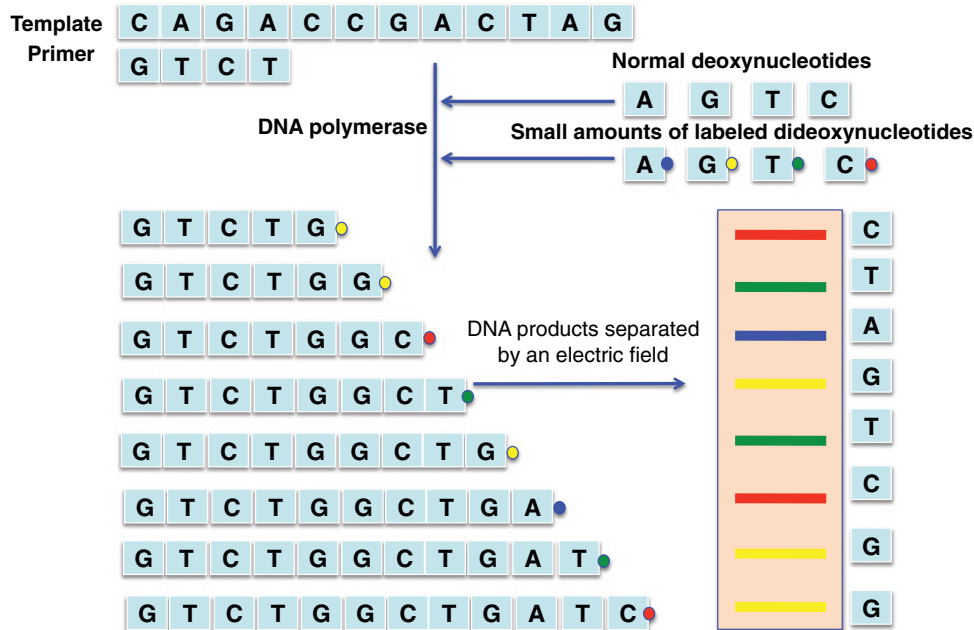


Figure 39-24 DNA sequencing (Sanger method). To perform DNA sequencing using the Sanger method, PCR is performed. In addition to the four regular deoxynucleotides, small amounts of four fluorescence-labeled 2',3'-dideoxynucleotides are included in the reaction mixture. Incorporation of a 2',3'-dideoxynucleotide by the DNA polymerase results in termination of the elongation reaction. Therefore, the last base incorporated into that DNA strand will correspond to the labeled 2',3'-dideoxynucleotide. The DNA fragments are size analyzed by gel or capillary electrophoresis. A laser beam can be used to read the four different fluorescent labels corresponding to the four bases.

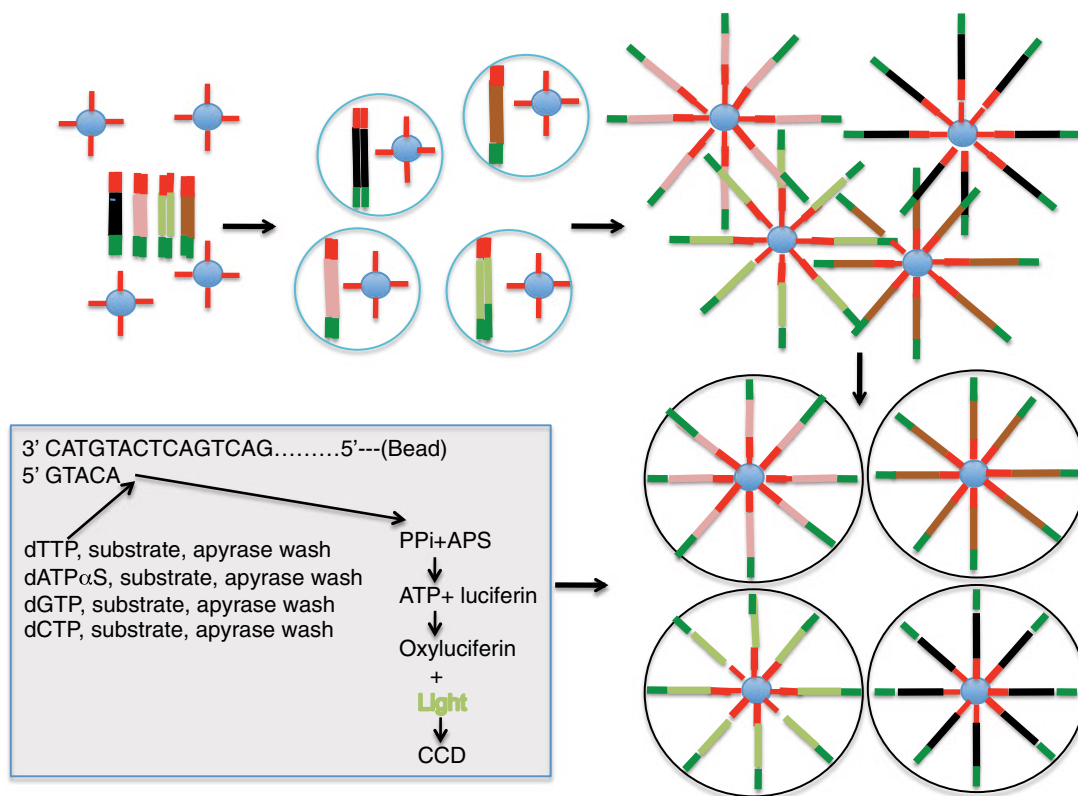


Figure 39-25 Pyrosequencing. In the pyrosequencing method (Roche 454; Roche, Basel, Switzerland), an adapter-flanked shotgun library of the DNA to be sequenced is constructed *in vitro*. The adapter sequences are all the same and can be used to perform a multitemplate PCR with a single primer pair. The other primer has a 5'-biotin tag that binds to micrometer-scale (28- μ m) streptavidin-coated beads. After binding to the beads is complete, a PCR is performed in water-in-oil emulsions at a very low concentration of the template so that, in the majority of the bead compartments, there is only one template molecule. The products of the PCR are then captured by primers on the surface of the beads. The water-in-oil emulsion is subsequently broken, and the beads are treated with denaturant to remove untethered strands, enriched for amplicon-bearing beads, and transferred to arrays of picoliter wells so that only one bead can fit inside a well. The sequencing primers are hybridized to the universal adapter immediately adjacent to the start of the segment to be sequenced. Each microwell has channels that allow the addition of the enzymes required for sequencing and reaction detection, including the *Bacillus stearothermophilus* polymerase, single-stranded binding protein, ATP sulfurylase, luciferase, and the substrates luciferin and adenosine 5'-phosphosulfate. For sequencing, one side of the array functions as a flow cell for introducing and removing reagents and the other side has a charge-coupled device (CCD) for signal detection. At each cycle, a single unlabeled nucleotide is introduced in each well (dATP α S, which is not a substrate for luciferase, is added instead of dATP). On the templates where the complementary nucleotide is present, this results in the incorporation of the incoming nucleotide, and pyrophosphate is released. For each nucleotide incorporated, a pyrophosphate is generated that is detected by the CCD. On the other hand, if the complementary nucleotide is not present, no light is produced. The well is then washed with apyrase to remove unincorporated nucleotide, and then the next nucleotide is flowed. A limitation of this approach is the presence of segments with the same base, such as TT or CCCCC. Although the intensity of the luminescence should be proportional to the number of nucleotides incorporated, this is not easy to quantitate. An advantage of the system is that it can sequence 400×10^6 to 600×10^6 bp per run at lengths of 400 to 500 bp. (Adapted from Shendure and Ji, *Nat Biotechnol* 26:1135–1145, 2008.)

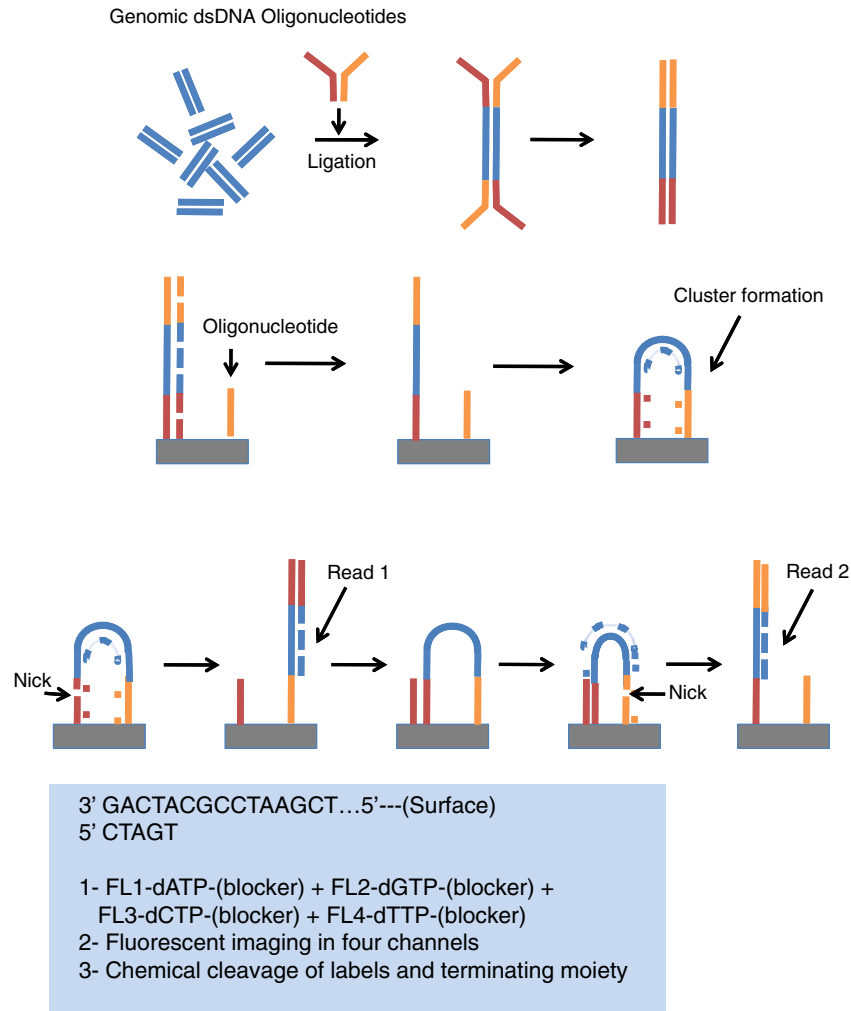


Figure 39-26 Cluster DNA sequencing using reversible dye terminators. In cluster DNA sequencing (Illumina Genome Analyzer; Illumina, Inc., San Diego, CA), the dsDNA from the genome to be sequenced is sheared and ligated to a pair of oligonucleotides. The DNA is then amplified using two oligonucleotide primers, yielding double-stranded blunt-ended fragments with a different adapter on either end. To generate clonal single molecule arrays, the dsDNA is denatured and the single strands are annealed to oligonucleotides attached to the surface of a flow cell. A new strand is copied from the original ssDNA, using as a primer the surface-bound oligonucleotide. The original ssDNA is removed by denaturation, and the adapter sequence at the 3' end of each copied strand is annealed to a new complementary oligonucleotide that is attached to the surface of the flow cell, generating a bridge-like structure. A dsDNA is subsequently synthesized, and multiple cycles of annealing, extension, and denaturation result in the synthesis of DNA clusters. Bridge amplification, therefore, yields multiple clusters attached to a surface, with each cluster representing a single template. To sequence each cluster, the DNA is linearized using a cleavage site within one adapter oligonucleotide. These templates are now sequenced by utilizing reversible dye terminator nucleotides. Each nucleotide is labeled with a different color of fluorophore, and every time one of these nucleotides is incorporated the extension reaction is terminated. The fluorophore is linked to the pyrimidine or purine bases through a cleavable disulfide linker. The steric hindrance of the cleavable fluorophore is what confers terminating properties to the free 3'-OH-modified nucleotides. In each cluster, the nucleotide that has been incorporated is detected before the terminator group is removed and the next labeled reversible dye terminator nucleotide is added. Imaging, using four channels to detect the incorporation of each of the four nucleotides in each cluster, determines the sequence of the DNA. (Adapted from Bentley et al., *Nature* 456:53–59, 2008; Turcatti et al., *Nucleic Acids Res* 36:e25, 2008; and Shendure and Ji, *Nat Biotechnol* 26:1135–1145, 2008).

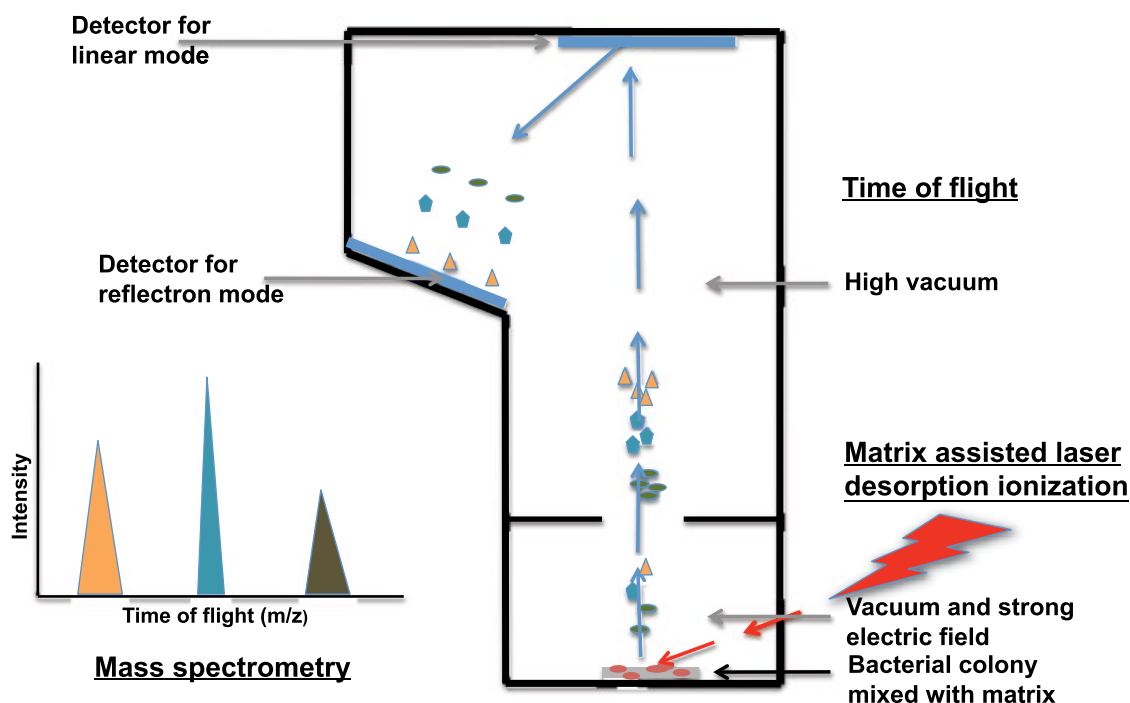


Figure 39-27 MALDI-TOF MS. Mass spectrometry is an analytical method that allows fast and precise determination of the mass of molecules, including proteins and nucleic acids, in a range from 100 Da to 100 kDa. In the case of MALDI-TOF MS, molecules such as proteins are embedded in a matrix consisting of low-molecular-weight organic acids, frequently α -cyano-4-hydroxy-cinnamic acid. As a result of exposure to laser pulses, energy is transferred from the matrix to the analyte molecule. The analyte is desorbed (removed) into the gas phase, and the ionized molecules are accelerated in the flight tube by electric potentials based on their mass/charge ratio (m/z). The ionized molecules collide with a detector, generating a profile that is then compared with a collection of patterns of well-characterized controls. The method used for the identification of bacteria requires approximately 10^4 to 10^5 CFU from a well-isolated colony. In some systems the bacteria are directly transferred to the mass spectrometry plate. Alternatively, the bacteria (or other pathogens, such as fungi) are first fixed with ethanol, and the proteins are extracted with formic acid and acetonitrile before they are mixed with the matrix solution. Most of the bacterial components detected by MALDI-TOF MS are intracellular proteins in the 4- to 15-kDa range, including ribosomal and mitochondrial proteins, cold and heat shock proteins, DNA-binding proteins, and RNA chaperone proteins. Mass spectrometry is also being used to detect and identify amplified nucleic acids and to carry out sequencing.

Total Laboratory Automation

40

The clinical microbiology laboratory has been revolutionized with new technological advances and systems, including matrix-assisted laser desorption ionization-time of flight mass spectrometry (MALDI-TOF MS), multiplex molecular assays, and microbial cell-free DNA and RNA sequencing. Well-established automated systems in the clinical microbiology laboratory include continuous-monitoring blood culture systems, semiautomated microbial identification and antimicrobial susceptibility testing (AST) systems, and fully automated molecular assays. With most of these systems, however, some tasks, such as specimen processing and culture evaluation, remain largely manual. Even though the first automated modules for sample processing were introduced in the 1970s, complete laboratory automation in the microbiology laboratory has lagged behind that in other areas of the clinical laboratory, such as hematology, chemistry, and molecular biology, where automation has been implemented over the past several decades. Some of the reasons for the delay in developing and adopting automated solutions include the complexity of culture evaluation as well as the consistency, volume, and variability of specimen types. However, more recently there has been a gradual acceptance of full laboratory automation within the microbiology community. Reasons for greater demand for microbiology automation include an increase in the number of specimens, wide use of liquid-based transport systems, consolidation of laboratories, and shortages of qualified workforce. Automation has been shown to improve standardization of initial specimen processing, decrease

turnaround time for identification and antimicrobial susceptibility test results, increase productivity and efficiency, avoid specimen cross-contamination, and diminish risk of laboratory exposures. Currently, the major steps that have been automated are specimen inoculation, plate management, digital imaging of culture plates, and plate imaging segregation. The instruments available are divided into specimen processing devices, automated plate readers with interpretation using artificial intelligence, and systems that offer partial or total laboratory automation (TLA).

Some of the available specimen processors are the Autoplak (NTE-Healthcare, Barcelona, Spain), BD Innova (BD Diagnostics, Sparks, MD), the BD Kiestra Inoqula (BD Kiestra B.V., Drachten, Netherlands), the PreLUD (I2A Diagnostics, Montpellier, France), and the WASP DT (Copan Diagnostics, Murrieta, CA). All these instruments are capable of automating the handling of a variety of liquid-based specimens and selecting, labeling, inoculating, and streaking the appropriate agar plates. Additional features include slide preparation, inoculation of broth and tube media, subculturing broth media, and dispensing antibiotic disks. It has been shown that automated instruments provide standardization of specimen processing and streaking, which results in more isolated colonies and thus a decrease in the number of subcultures necessary for organism identification and antimicrobial susceptibility testing.

APAS Independence (Clever Culture Systems, Zurich, Switzerland) is the first stand-alone FDA-cleared artificial intelligence technology for fully automated imaging,

analysis, and interpretation of urine culture plates. The plates are manually cultured, incubated, and placed in the instrument; the plate is then imaged, analyzed, and interpreted to detect the presence or absence of microbial growth. Only urine cultures with growth need to be reviewed by a microbiologist. At this point, published data on this system are limited.

The most widely used partial or total laboratory automation systems are the Kiestra TLA (Becton, Dickinson and Company, Franklin Lakes, NJ) and the WASPLab (Copan Diagnostics). These systems offer an integrated model of automation that includes the following: a conveyor system to move the specimens and plates through the entire process, including discarding them once the culture is complete; a specimen processor; an incubator; and a digital imaging system that includes a reader and display module. Once inoculated, plates are individually stored and kept at constant and uniform temperature. Images of plates are taken at programmable time intervals using several exposures and a variety of angles. The microbiologist via the computer (telebacteriology) at the workstations, or other alternative locations, reviews the images of the cultures (Fig. 40-8). Subsequently, colonies of interest are labeled on the screen, and when necessary, physical plates can be requested to be delivered to the microbiologist for further workup.

Kiestra TLA modules include the SorterA, BarcodA, Inoqula, the ReaA Compact (CO₂ and aerobic) with

digital imaging, and the ErgonomicA workbenches (Fig. 40-2 through 40-5). The WASPLab modules (Fig. 40-5 and 40-6) include the WASP DT, CO₂ and aerobic incubator with digital imaging. Additional features in development include the capability to sort and send specimens to the appropriate instrument(s) for laboratories using multiple specimen processors, automated bacterial and yeast colony selection, MALDI-TOF MS target seeding, McFarland suspension preparation, robotic assistance with manual processes, and artificial intelligence to automate reading and sorting of culture plates.

The degree of automation and variability of methods in the near future will expand. The continued development and modular nature of these systems will allow more flexibility for individual laboratories to achieve their desired level of automation. Automation systems can positively affect workflow, productivity, turnaround time, and quality of work performed by the clinical microbiology laboratory. Importantly, patient care will improve, particularly if communication with attending physicians, pharmacists, and other health care personnel is efficient and open. When considering incorporating automation into a laboratory, both the cost of the equipment and renovation of the physical space must be taken into consideration. These factors, however, need to be assessed in the context of improved patient care.



Figure 40-1 Liquid-based transport systems. Multipurpose flocked swabs and other types of collection and transport systems (Copan Diagnostics, Murrieta, CA) for sputum, feces, and urine samples are commercially available. Standardization of samples by using liquid-based transport systems has facilitated the implementation of automated processing. (Photo courtesy of Copan Diagnostics, Murrieta, CA.)

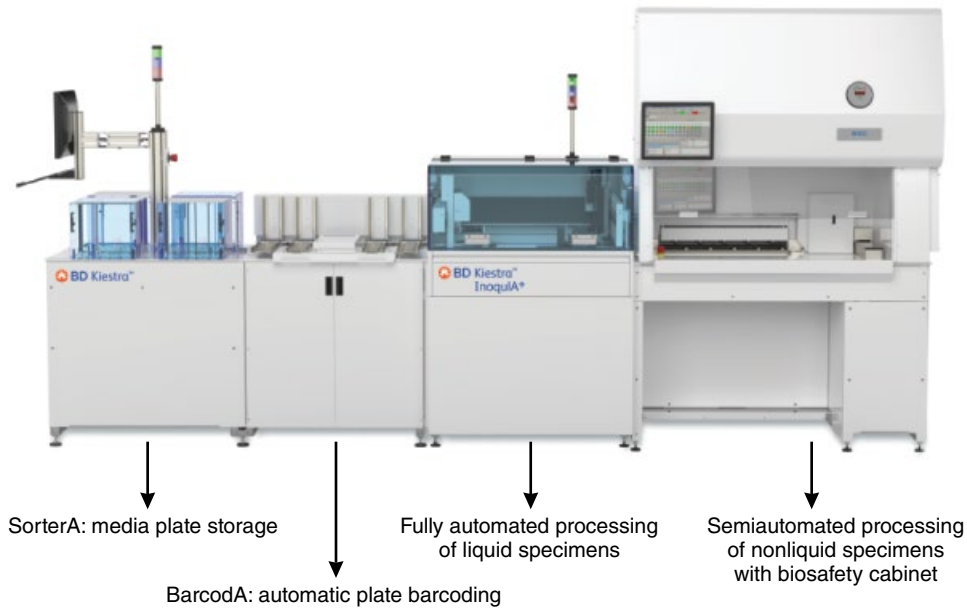


Figure 40-2 BD Kiestra Inoqula+ specimen processor. The specimen processor shown consists of a fully automated and a semi-automated module for liquid and nonliquid samples, respectively. The system is mainly designed to process samples in batches. Liquid samples are automatically agitated, decapped, and recapped. Appropriate media are automatically selected, and samples are barcoded and transported to the automated or semi-automated module for plating. Plates are inoculated using a pipette with a minimum of 10 μ l and streaked with a magnetic rolling bead technology using predefined or customizable patterns. It also offers the capacity of inoculating slides and broth tubes. The system is equipped with a HEPA filter. It has the capacity to house up to 12 different types of media and a total of 612 plates and 288 specimens. It can process around 220 to 300 inoculations per hour. Space requirements with biosafety cabinet: depth, 948 mm; width, 4,434 mm; height, 2,350 mm; weight, 1,350 kg. (Photo courtesy of Becton, Dickinson and Company, Franklin Lakes, NJ.)

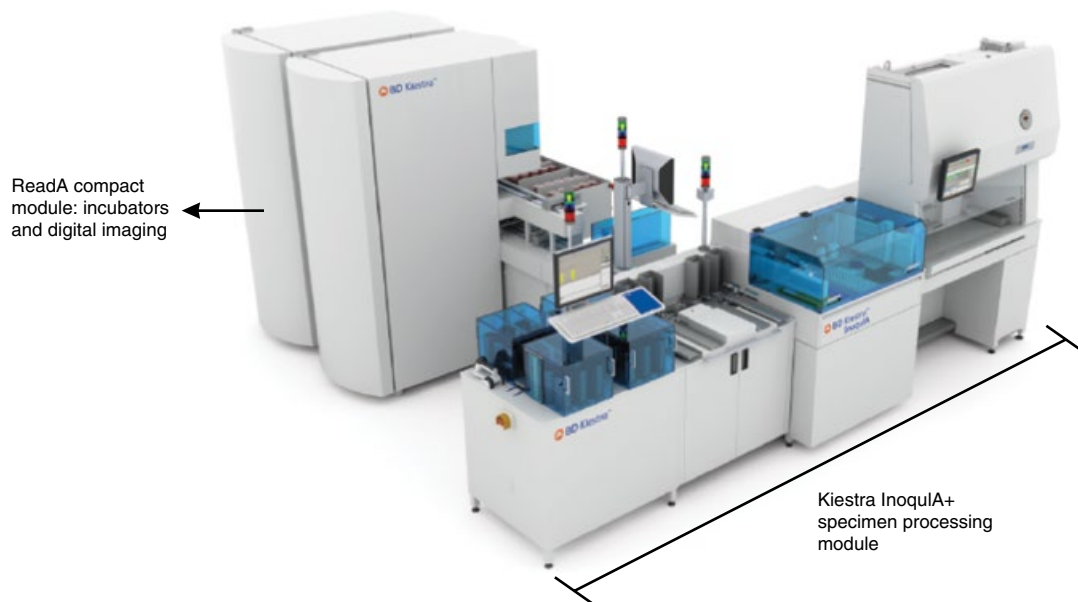


Figure 40-3 BD Kiestra Work Cell Automation (WCA) system. The WCA system is a compact modular solution to automated specimen processing, plate incubation, and digital imaging. The specimen processing module can be linked to up to three BD Kiestra ReadA Compact intelligent incubation modules with individual plate storage and digital imaging systems. Upon viewing the digital images, an additional workup of specimens can be done on remote workbenches. Space requirements with one incubator: depth, 3,348 mm; width, 4,434 mm; height, 2,300 mm; weight, 2,005 kg. (Photo courtesy of Becton, Dickinson and Company, Franklin Lakes, NJ.)

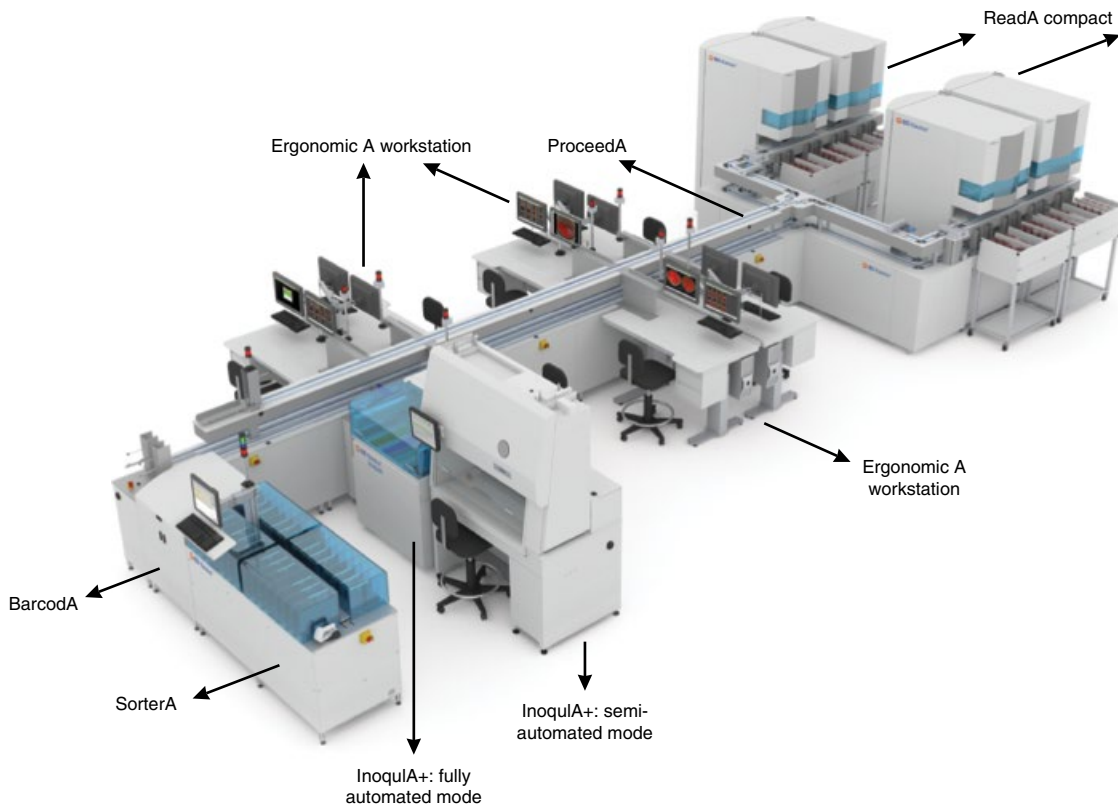
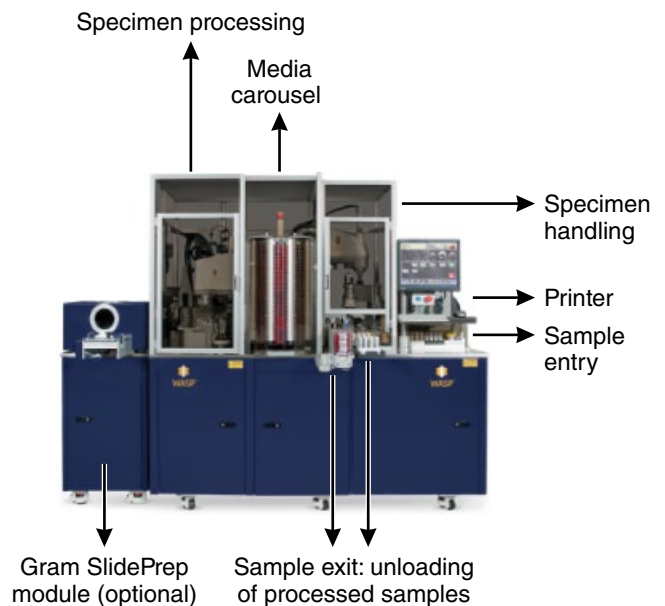


Figure 40-4 BD Kiestra Total Lab Automation (TLA) system. The TLA system includes the SorterA, the BarcodA, the InoquA, the ReadA Compact, and the ErgonomicA (workbenches) connected by ProceedA, a two-way automated plate transportation track. One line is dedicated to transportation of plates for inoculation from the SorterA (storage) to the InoquA or to the workbenches. The second line connects the incubator to the workbenches. It has a capacity to store and use up to 48 different media types. The ReadA Compact incorporates incubation (CO₂ and aerobic) and imaging technologies. The digital images can be reviewed by telebacteriology at the connected workbenches, and additional workup of the culture can be selected on the screen. Space requirements (dependent on configuration): SorterA/BarcodA: depth, 830 to 1,380 mm; width, 2,281 to 2,720 mm; height with signaling lamp, 1,950 mm; weight, 300 to 500 kg. InoquA+ TLA: depth, 933 mm; width, 2,659 mm; weight, 700 kg. ErgonomicA: depth, 850 mm; width, 1,650 to 2,200 mm; and weight, 130 to 160 kg. ReadA Compact: depth, 1,594 mm; width, 1,000 mm; height, 2,300 mm; weight, 500 kg. (Photo courtesy of Becton, Dickinson and Company, Franklin Lakes, NJ.)

Figure 40-5 Walk-Away Specimen Processor (WASP) DT. The WASP DT performs only plating of liquid-based samples and streaking of culture plates. The system receives continuous sample loading and can agitate, centrifuge, decap, and recap specimens. The media carousel holds up to 70 plates and nine different types of media. Plates, tubes, and slides for Gram stains are automatically labeled. Plates are streaked with reusable metal loops that deliver 1 µl, 10 µl, or 30 µl. The inoculation streak pattern can be selected from a library of classic or customizable patterns. It can handle and inoculate up to 150 plates per hour. The system is equipped with a HEPA filter. Optional features include slide preparation, dual loop inoculation of a single sample, broth inoculation, and two disk dispensers for automated placement of disks onto plated media, one for identification (e.g., optochin and bacitracin) and one for antimicrobial susceptibility tests. Space requirements: depth, 1,104 mm; width, 2,069 mm; height, 1,929 mm; weight, 589 kg. (Photo courtesy of Copan Diagnostics, Murrieta, CA.)



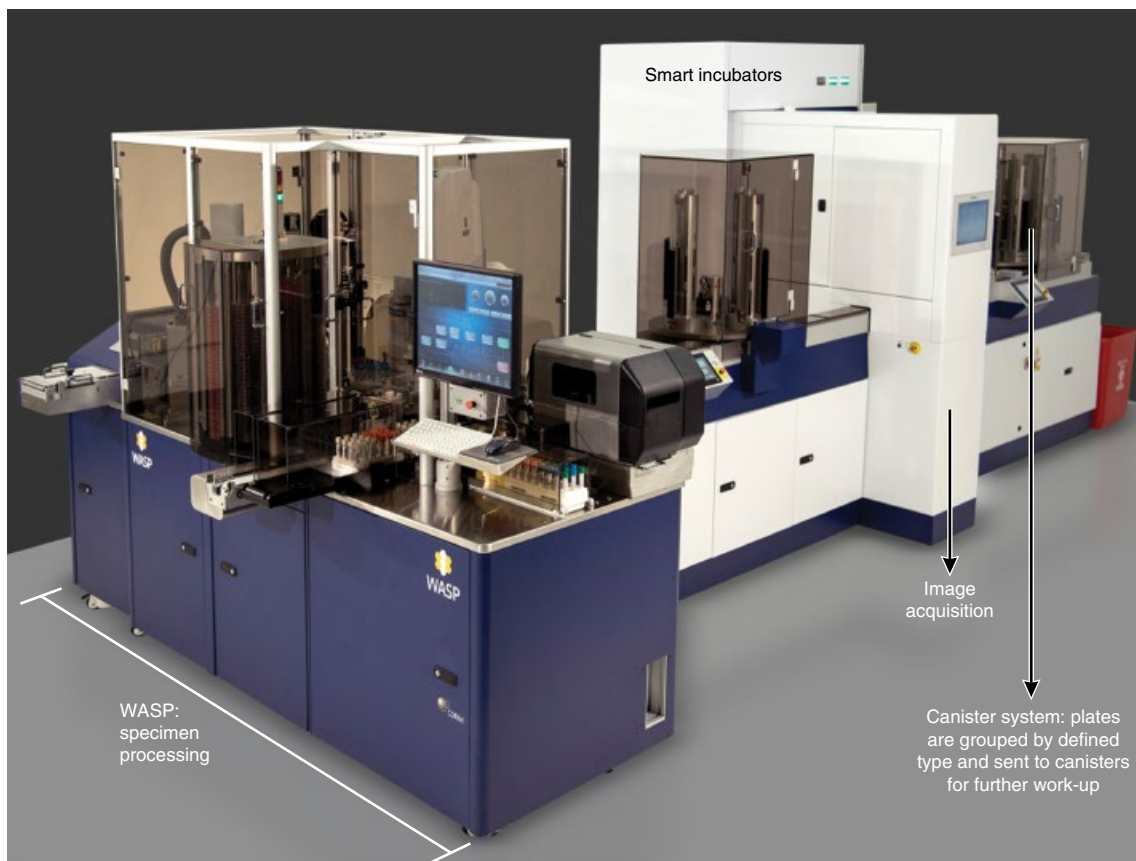
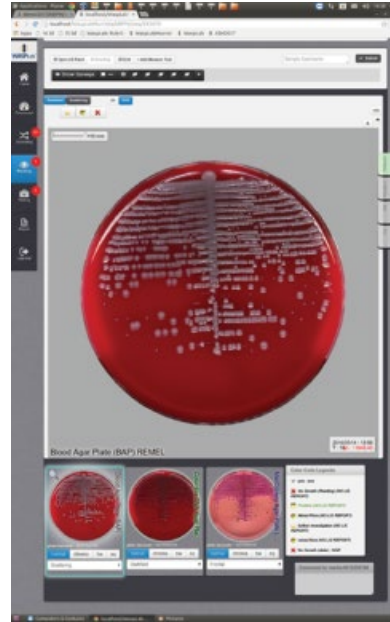


Figure 40-6 WASPLab automated system. The WASPLab system includes different modules connected by a unidirectional conveyor track. The WASP DT includes smart incubation (CO₂ and aerobic), digital microbiology, and artificial intelligence. Single and double smart incubators have the capacity for 795 and 1,590 plates, respectively. The reading of the digital images and additional workup are done on remote workbenches. Space requirements for WASP DT with a single incubator: depth, 1,158 mm; width, 853 mm; height, 2,316 mm; weight, 553 kg. (Photo courtesy of Copan Diagnostics, Murrieta, CA.)

Figure 40-7 Digital imaging. Shown here are components of the WASPLab (A to C) and Kiestra LTA (D and E) systems. These include an industrial camera (A), digital images (telebacteriology) (B and E), and workstations (C and D). Digital imaging and telebacteriology are a major advance for the clinical microbiology laboratory. Digital imaging software enables the remote assessment of organism growth and can replace the manual reading of plates. The camera takes an image of the plate at time zero and subsequent images at specified time intervals based on user-defined protocols. The plate images are read and interpreted using a monitor at remote or connected workstations. Colonies are selected by touch screen or mouse and the workup designed (such as MALDI-TOF MS, AST, or subculture). Plates requiring further workup are requested to be delivered to the connected workstations or canisters. Additionally, use of digital imaging associated with artificial intelligence can allow the triaging of culture plates and improve laboratory efficiency by the rapid identification and reporting of negative cultures. ([A to C] Photos courtesy of Copan Diagnostics, Murrieta, CA. [D and E] Photos courtesy of Becton, Dickinson and Company, Franklin Lakes, NJ.)



A



B



C



D

BD Synapsys™

Home > Culture Reading > Accession#: KP022002

Recently Viewed Cultures | Search for Culture

Mark as Read | Final Discard | Undo All | Save

Blood cultures 2 Remaining

ACCESSION # KP022002

LAST NAME: Abbatini
FIRST NAME: John
PATIENT ID: K128149
BIRTHDATE: 06/12/1981

Culture Detail: Chocolate Agar - C10300101701

DRINK | VIEW | LIGHT | ZOOM

Imaged 1 days ago

05/16/2018 01:16PM | 24h | 48h | 72h

1 Isolate 1 | Report to LIS

Organism Name: (STAAUE) Staphylococcus aureus

Quantity: Select a quantity

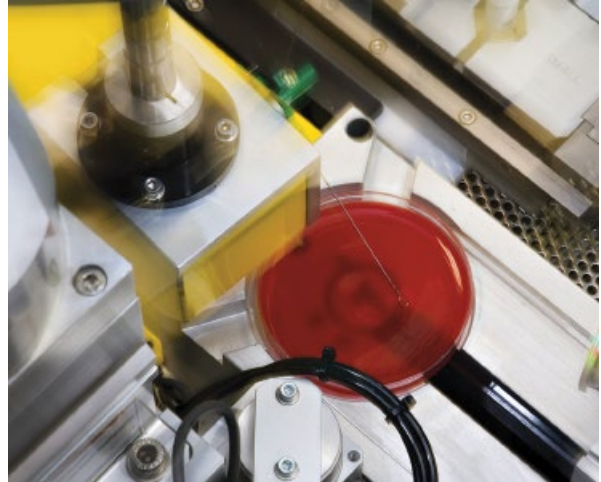
Ordered Tests:

Test	Date	Status	Result	Actions
KB Gram Positive	05/17/2018 2:29:37 pm	Complete		
MBT ID	05/17/2018 1:48:37 pm	Complete	STAAUE	
MAC 3D CO2	05/16/2018 1:06:37 pm	Ongoing	Negative	
TSA 3D CO2	05/16/2018 1:06:37 pm	Ongoing	Positive	
CHOC 3D CO2	05/16/2018 1:06:37 pm	Ongoing	Positive	

E



A



B

Figure 40-8 Streaking process. (A) Inoqula uses disposable magnetic beads. (Photo courtesy of Becton, Dickinson and Company, Franklin Lakes, NJ.) (B) WASP uses reusable metallic loops. (Photo courtesy of Copan Diagnostics, Murrieta, CA.)



Figure 40-9 APAS Independence. The APAS Independence is a stand-alone system that uses artificial intelligence to automate culture plate imaging, analysis, and interpretation. Space requirements: depth, 2,000 mm; width, 800 mm; height, 1,600 mm; weight, 330 kg. (Photo courtesy of Clever Culture Systems, Zurich, Switzerland.)

**A****B**

Figure 40-10 Additional modules. Shown here are components of the WASPLab, including the WASP-FLO (A) and Collaborative Robot (B). The WASP-FLO module can be used for streamlining samples in laboratories in which multiple sample processors are being used. It automatically sorts samples and directs them to the appropriate WASP DT. The Collaborative Robot module assists with manual processing of positive blood cultures, tissues, and traditional swabs. (Photo courtesy of Copan Diagnostics, Murrieta, CA.)

Stains, Media, Reagents, and Histopathology

41

Bacteria are identified in the clinical laboratory by a variety of methods, including microscopy, observation of growth characteristics, determining reactions to organic and inorganic compounds, and molecular techniques. Examination of histopathological sections can also contribute to the definitive diagnosis or exclusion of bacterial infections. This chapter presents images of the more common stains, media, and tests used in the diagnostic medical microbiology laboratory, as well as relevant histopathologic images. Gram staining is the most widely used

method for visualizing bacteria. Shown in this chapter are examples of the various sizes, shapes, and arrangements of both aerobic and anaerobic bacteria found in clinical specimens. Also included are some of the most common culture media used in the laboratory for demonstrating growth, isolation, colonial morphology, hemolysis, pigment production, and other distinguishing bacterial characteristics. The figures depict some of the key tests and histologic images that have been found to be most helpful for the detection and identification of clinical isolates.

STAINS

Gram Stain

Gram staining is one of the most important procedures in bacteriology. It is used to classify bacteria based upon their size, shape, arrangement, and Gram reaction. It was originally described in 1884 by Christian Gram; the modification currently in use was developed by G. J. Hucker in 1921. The reagents and stains used in Hucker's modification include crystal violet, Gram's iodine, acetone alcohol, and safranin. The figures in this section demonstrate a variety of morphotypes as well as Gram stain reactions.

Hematoxylin and Eosin Stain

Hematoxylin and eosin (H&E) stain is used routinely in histopathological sections, as it displays the tissue morphology. Hematoxylin dyes the host cell nucleus

with a deep-purple blue color, and eosin stains the host cytoplasm and the extracellular matrix with a variable degree of pink color. Microorganisms, in particular bacteria and fungi, are also stained with H&E.

Special Stains

The term "special stains" traditionally refers to all stains other than H&E stain used for histopathological sections. It includes a variety of methods and dyes used to highlight tissues, cells, substances, and microorganisms. The special stains used regularly to visualize microorganisms include, but are not limited to, Grocott methenamine silver (GMS), modified Brown and Hopps stain (tissue Gram stain), Warthin-Starry stain, Kinyoun's stain, and Fite stain.

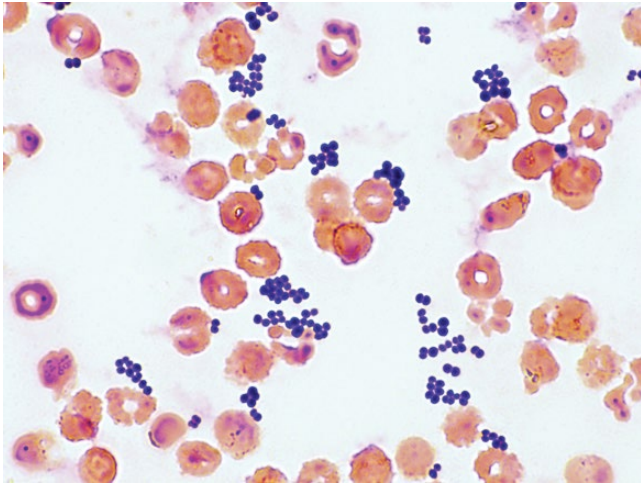


Figure 41-1 Gram-positive cocci in pairs and clusters.

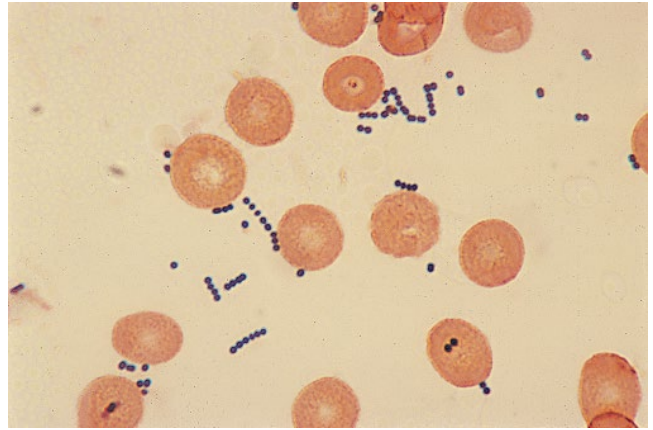


Figure 41-2 Gram-positive cocci in pairs and short chains.

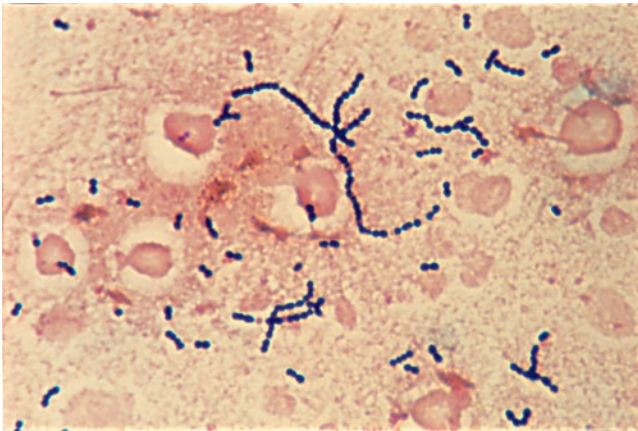


Figure 41-3 Gram-positive cocci in pairs and chains.

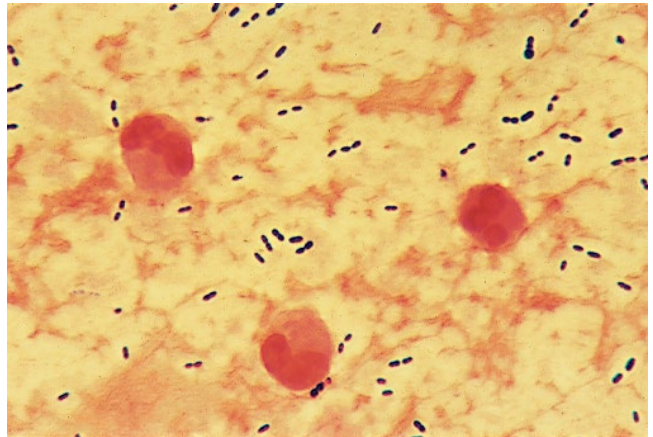


Figure 41-4 Lancet-shaped, Gram-positive diplococci. Shown here is the typical morphology of *Streptococcus pneumoniae*. The clear areas surrounding the organisms are the capsules of *S. pneumoniae*.

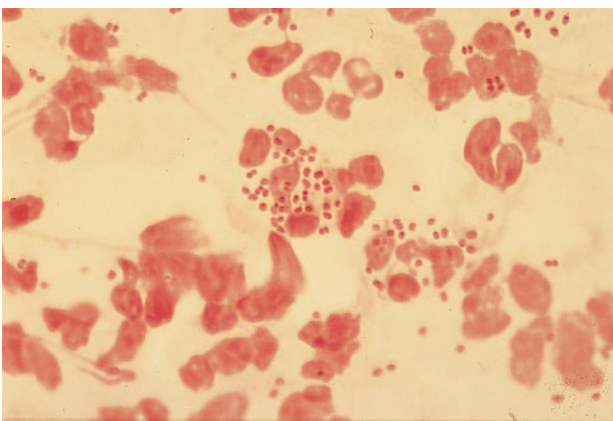


Figure 41-5 Intracellular, Gram-negative diplococci.

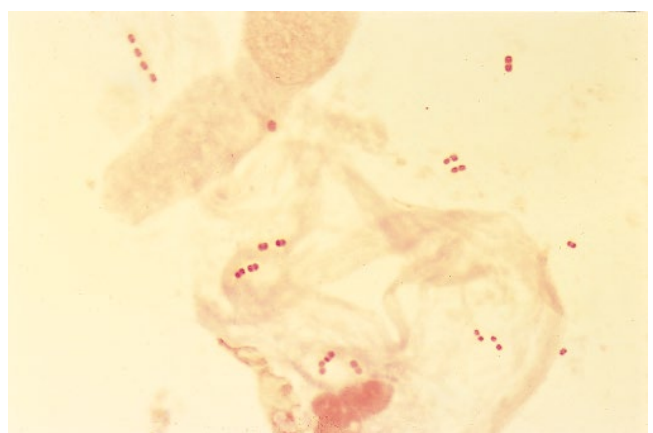


Figure 41-6 Small, Gram-negative coccobacilli.

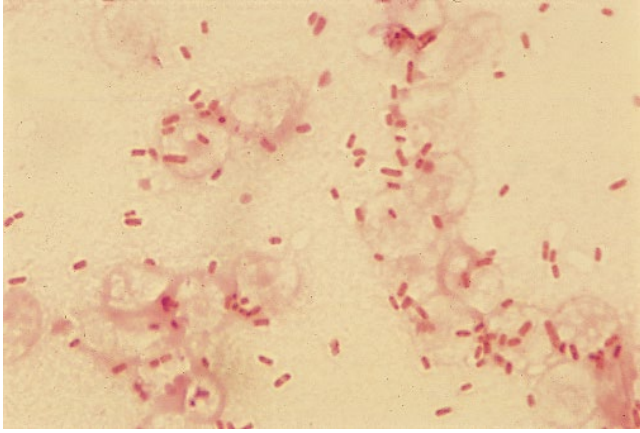


Figure 41-7 Short, Gram-negative bacilli with bipolar staining.

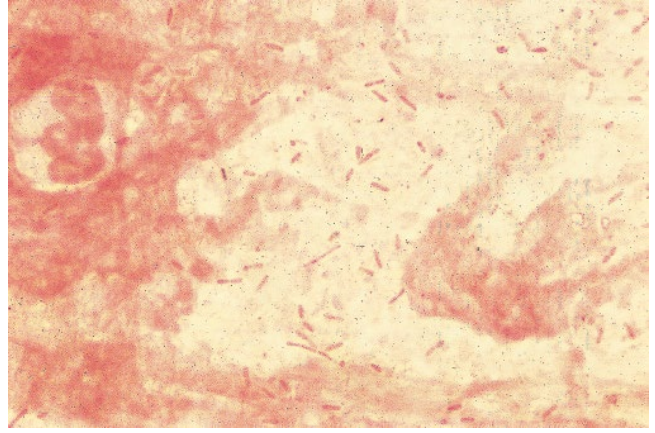


Figure 41-8 Long, slender, Gram-negative bacilli.

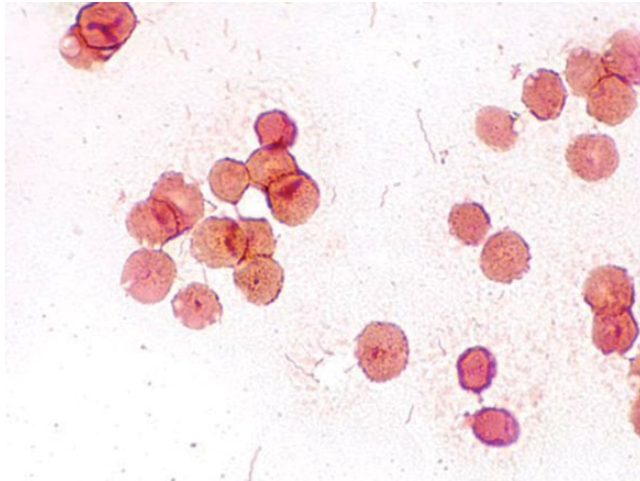


Figure 41-9 Curved, pleomorphic, Gram-negative bacilli resembling *Campylobacter*.

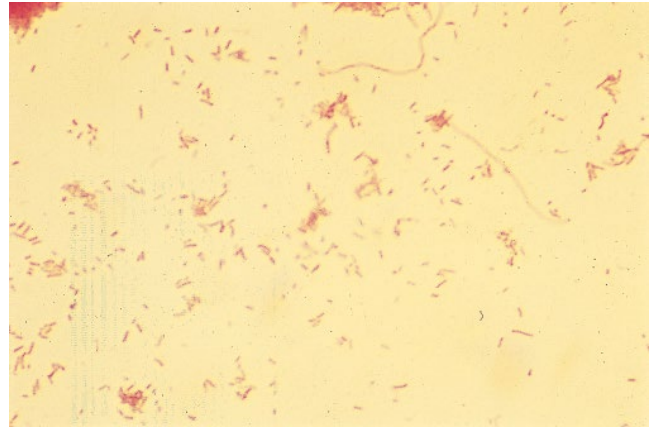


Figure 41-10 Long, slender, pleomorphic, Gram-negative bacilli resembling anaerobic organisms.

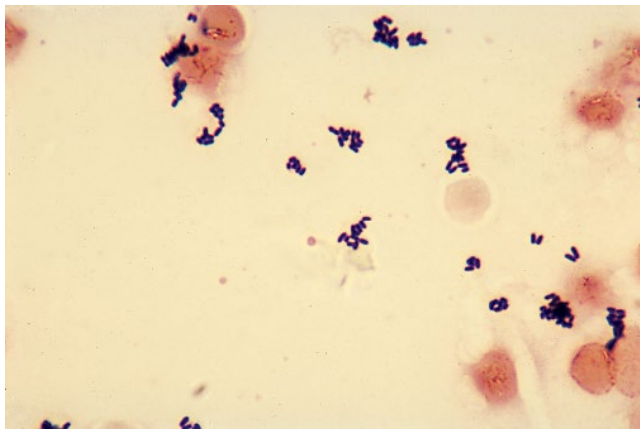


Figure 41-11 Short, Gram-positive bacilli in palisade formation.



Figure 41-12 Long, Gram-positive bacilli.

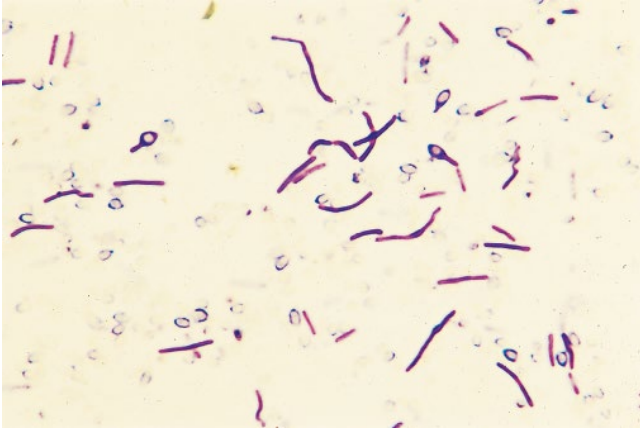


Figure 41-13 Large, Gram-positive and Gram-variable bacilli with terminal spores.

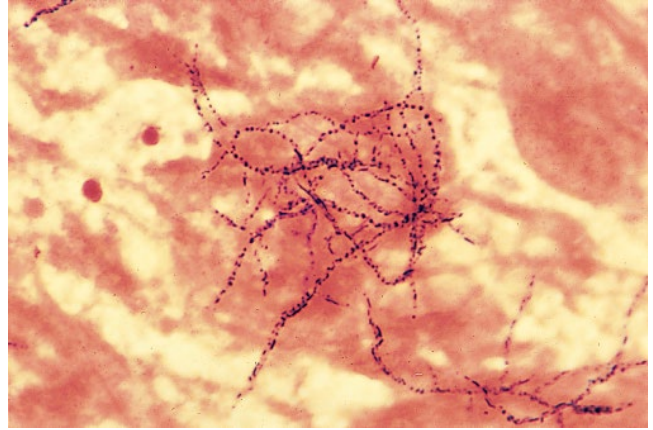


Figure 41-14 Branching, Gram-positive bacilli.

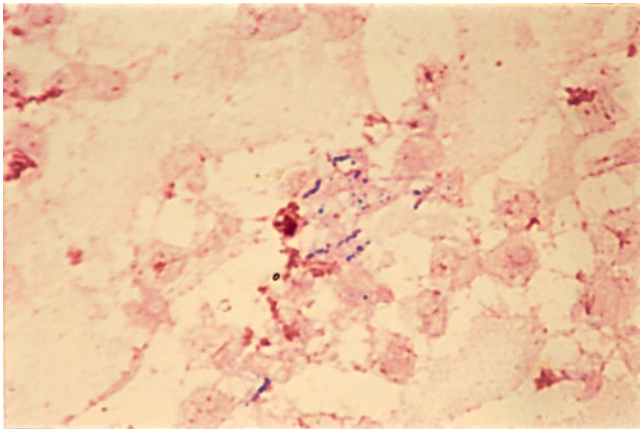


Figure 41-15 Gram-positive, beaded bacilli, suggestive of mycobacteria.

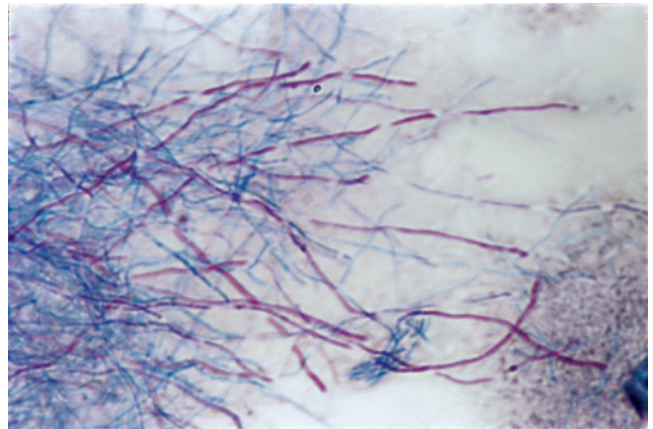
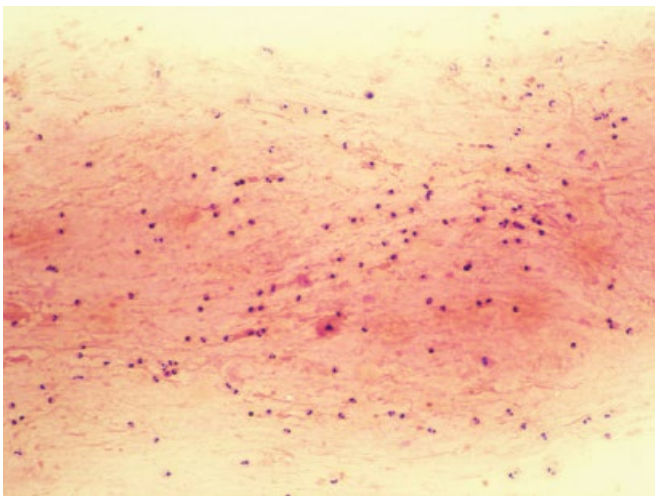
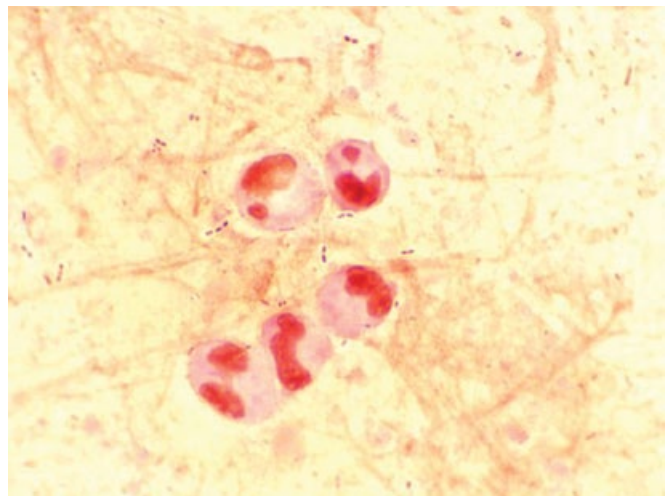


Figure 41-16 Partially acid-fast stain with filamentous branches resembling *Nocardia* spp.

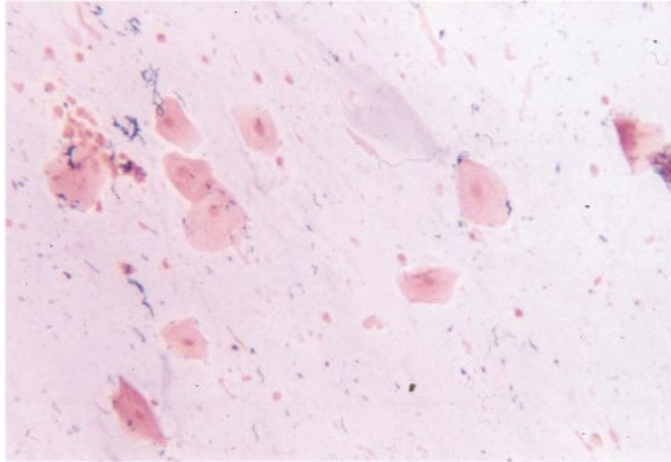


A

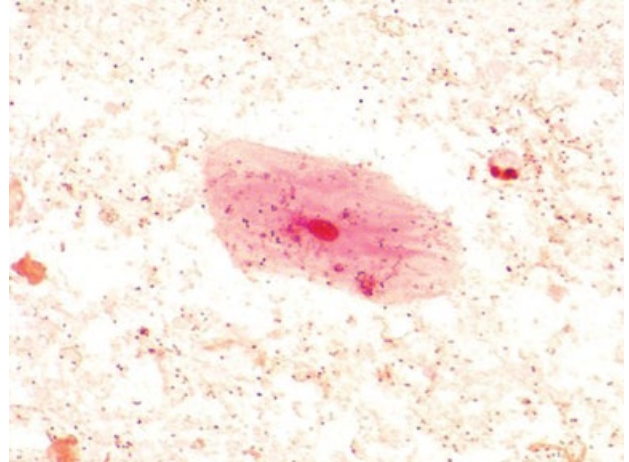


B

Figure 41-17 Gram stain of a high-quality sputum specimen. The presence of many polymorphonuclear leukocytes (PMNs) is suggestive of a good-quality specimen that is acceptable for further workup. Here there appear to be several PMNs when observed under a 10× objective (A). This is confirmed by examining the PMNs under a 100× objective (B).



A



B

Figure 41-18 Gram stain of a low-quality sputum specimen. The presence of many squamous epithelial cells suggests that the specimen may have been contaminated with normal oral pharyngeal microbiota, and a repeat specimen should be requested if possible. Shown here are squamous epithelial cells observed under lower-power magnification (10× objective) (A) and under oil immersion (100× objective) (B), indicating that the specimen was contaminated with oral pharyngeal microbiota.

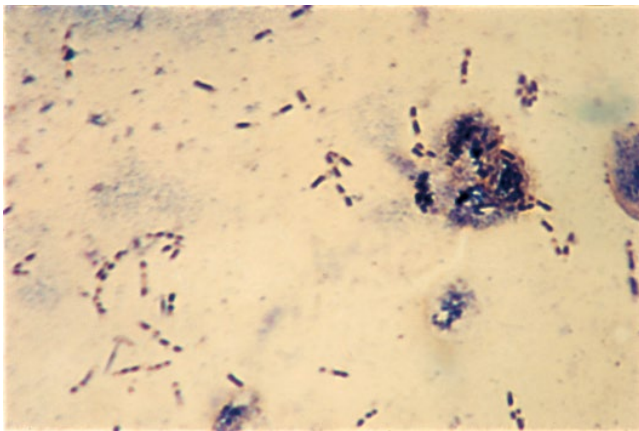


Figure 41-19 Underdecolorized Gram stain. The organisms, cellular material, and background appear purple, suggesting that the slide has not been properly decolorized.

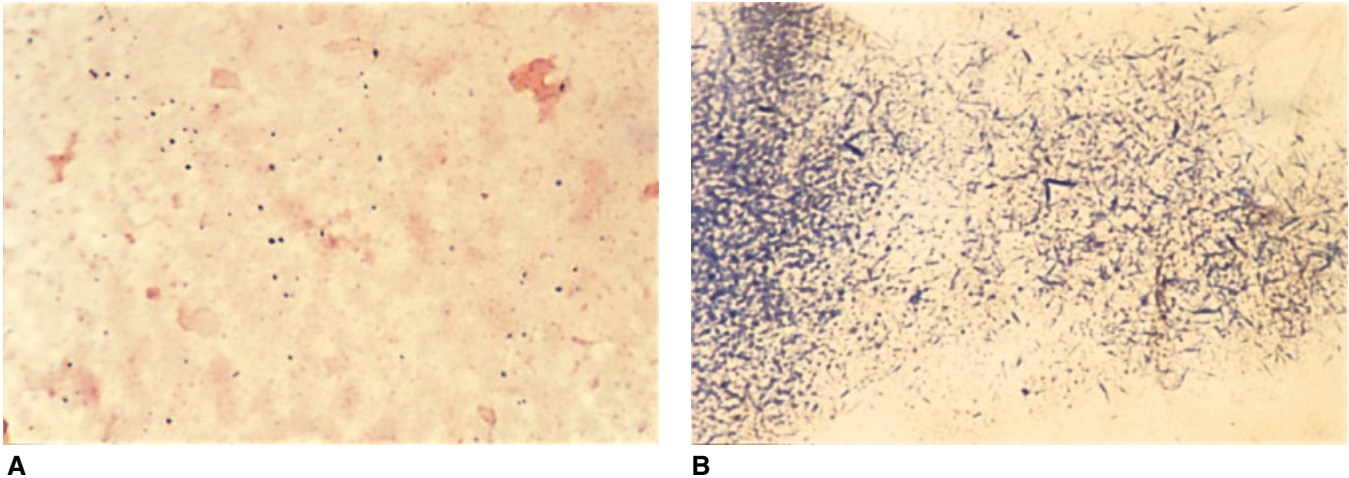


Figure 41-20 Gram stains containing artifacts, crystals, and precipitated stain. (A) Shown here are purple-staining coccoid structures of uneven sizes, which may be confused with Gram-positive cocci. However, no organisms grew aerobically or anaerobically; therefore, these were determined to be artifacts. (B) These rod-like structures, which can be confused with Gram-positive bacilli, are deposits from the crystal violet stain. Precipitated stain appears in the background.

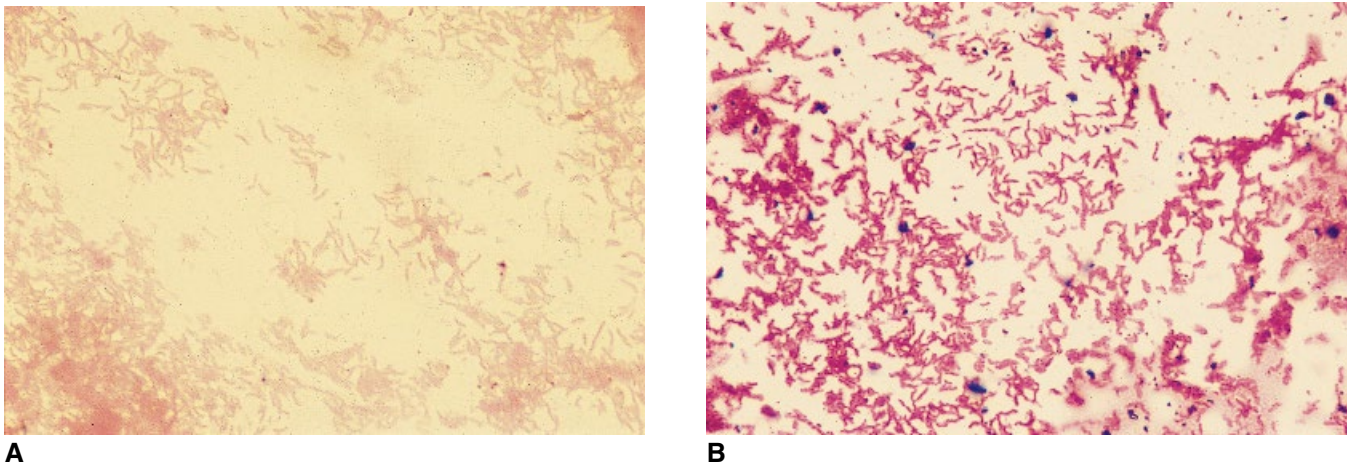


Figure 41-21 Gram stain with carbol fuchsin counterstain. Carbol fuchsin can be used to counterstain faintly staining, Gram-negative organisms. In this modification, the decolorizer is a 1:3 mixture of reagent-grade acetone and 95% ethanol and the counterstain is carbol fuchsin or 0.8% basic fuchsin. Gram-negative organisms such as *Bacteroides*, *Fusobacterium*, *Legionella*, *Campylobacter*, and *Brucella* spp. stain a darker pink when carbol fuchsin is used as the counterstain. In these examples, *Campylobacter* organisms are stained with the routine Gram stain, which includes safranin as the counterstain (A), and the carbol fuchsin modification (B). The morphology of these organisms is better defined on a Gram stain counterstained with carbol fuchsin rather than with safranin.

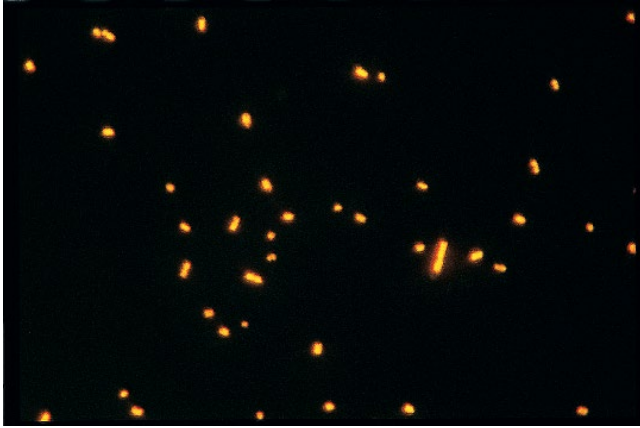


Figure 41-22 Acridine orange stain. Acridine orange is a fluorochrome dye that can bind nucleic acid. When stained with this dye in a buffered low-pH solution, bacteria and fungi appear orange, whereas host nucleic acid is green to yellow. This stain has been reported to be more sensitive than the Gram stain for detecting small numbers of bacteria and is used by some laboratories for blood culture broths, body fluids, and other specimens where small numbers of bacteria may be expected.

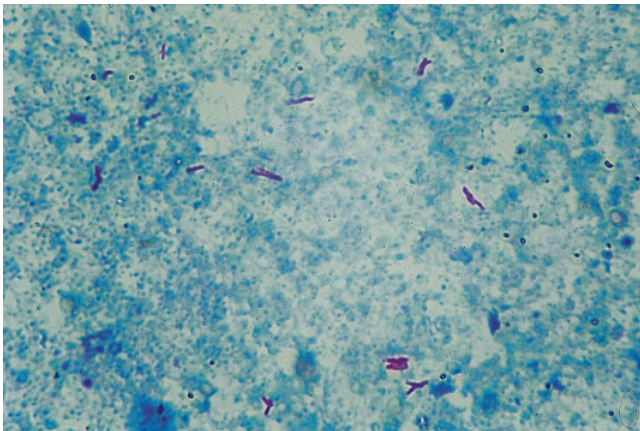


Figure 41-23 Acid-fast stain: Kinyoun stain of a sputum specimen. Pictured are *Mycobacterium tuberculosis* organisms, which appear red against a blue background. Mycobacteria have a high lipid content in their cell walls, which allows the binding of a fuchsin dye to mycolic acid so that it is not decolorized by acid alcohol. There are two variations on the acid-fast stain: the Ziehl-Neelsen method requires heating during staining with carbol fuchsin, whereas the Kinyoun procedure is performed at room temperature. Following staining, the preparation is decolorized using a solution containing ethanol and HCl followed by counterstaining with methylene blue. Acid-fast smears are useful not only for assisting with the primary diagnosis but also for monitoring response to antimycobacterial drug therapy. In general, cultures become negative before the smears because the organisms are no longer capable of replicating. Thus, quantitation of the organisms on the smear and the correlation with growth may provide an indication of the effectiveness of the therapy.

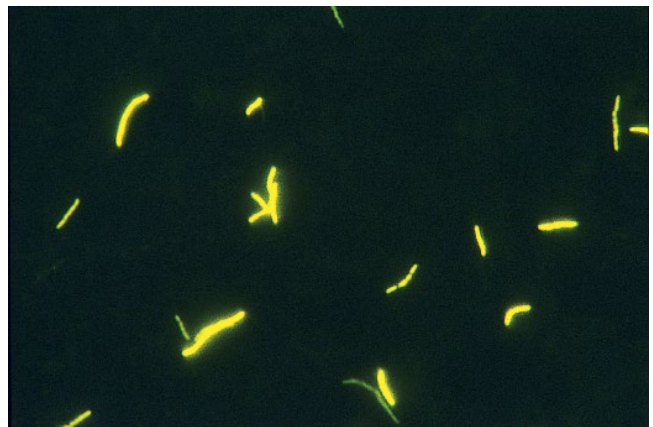


Figure 41-24 Acid-fast stain: auramine fluorochrome. Auramine O can also be used to stain mycobacteria. In this case, fluorochromes dissolved in ethanol and phenol were used to stain the preparation. The specimen was then decolorized with ethanol-HCl, and potassium permanganate was used as the counterstain. As shown here, mycobacteria appear yellow (golden when rhodamine is used) on a black background when observed under a fluorescence microscope. The advantage of the fluorochrome-stained smears is that mycobacteria can be seen with a 25 \times objective, significantly reducing the time required to scan a preparation, whereas a 100 \times objective is used when examining the Ziehl-Neelsen stain. However, it is important to emphasize that this type of staining is the direct result of a physicochemical binding of the dye to the lipid-rich cell of the organisms, and not an antigen-antibody reaction. Therefore, the staining is not specific.

PRIMARY PLATING MEDIA



Figure 41-25 Blood agar. Blood agar is a common medium used for the primary plating of clinical specimens as well as for the propagation of many laboratory bacterial strains. In general, blood agar is nonselective but is differential, in particular for species for which hemolysis is a key characteristic. Shown here is 5% sheep blood agar with a Trypticase soy broth base. There are several variable components of this formulation, including the type of red cells used, the percentage of cells, and the broth base used to prepare the medium. In this image, the beta-hemolytic organism is *Streptococcus pyogenes*.



Figure 41-26 MacConkey agar. MacConkey agar contains a peptone base with lactose and is used to distinguish rapid lactose fermenters from delayed lactose fermenters or nonfermenters. Crystal violet and bile salts in the medium inhibit Gram-positive organisms. Neutral red is the pH indicator. Colonies vary in color from pink to colorless and from dry with a doughnut shape to mucoid. Rapid lactose fermenters appear as pink colonies on MacConkey agar after overnight incubation, and their size and color intensity vary with different species. In this example, colonies of *E. coli* (at top) are dark pink, 2 to 3 mm in diameter, and surrounded by precipitated bile. Colonies of nonfermenters (bottom) are colorless or the color of the medium.

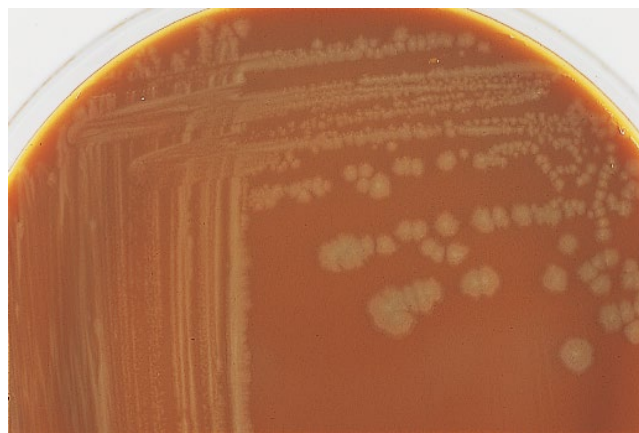


Figure 41-27 Chocolate agar. Chocolate agar is a highly enriched medium commonly used for growth of a variety of fastidious bacteria. While there are several variations of the formulation, in general it is composed of a GC agar base to which hemoglobin is added, which serves as a source of hemin (X factor) and gives the medium a brown or chocolate appearance. Other enrichments are also used, such as yeast extract or IsoVitaleX, which provides a source of NAD (V factor). Examples of organisms able to grow on chocolate agar but not on blood agar include some members of the genera *Neisseria* and *Haemophilus*.



Figure 41-28 Phenylethyl alcohol agar. Phenylethyl alcohol agar with 5% sheep blood is a selective medium for the isolation of Gram-positive organisms, particularly Gram-positive cocci, from specimens of mixed Gram-positive and Gram-negative microbiota. It also inhibits Gram-negative bacteria, particularly *Proteus* spp. The medium should not be used for determination of hemolytic reactions, since atypical reactions may be observed. The mixed Gram-positive organisms shown here were grown directly from a fecal culture. As expected, the Gram-negative organisms have been inhibited.

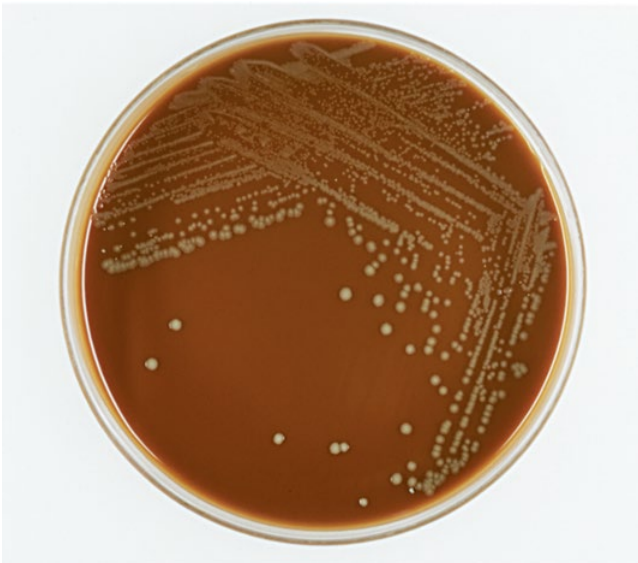


Figure 41-29 Modified Thayer-Martin agar. Modified Thayer-Martin (MTM II; BD Diagnostic Systems, Franklin Lakes, NJ) agar is based on Chocolate II agar, which contains an improved GC agar base, bovine hemoglobin, and BBL IsoVitaleX enrichment (BD Diagnostic Systems). Hemoglobin provides X factor (hemin) for *Haemophilus* spp. IsoVitaleX enrichment is a defined supplement that provides V factor (NAD) for *Haemophilus* spp. and vitamins, amino acids, coenzymes, dextrose, ferric ion, and other factors that improve the growth of pathogenic *Neisseria* spp. This selective medium also contains the antimicrobial agents vancomycin, colistin, nystatin (V-C-N inhibitor), and trimethoprim to suppress the normal microbiota. Vancomycin inhibits Gram-positive organisms, while colistin inhibits Gram-negative organisms, including *Pseudomonas* spp., but not *Proteus* spp. Trimethoprim is added to inhibit *Proteus* spp., and nystatin inhibits fungi. Shown here are colonies of *Neisseria gonorrhoeae*.

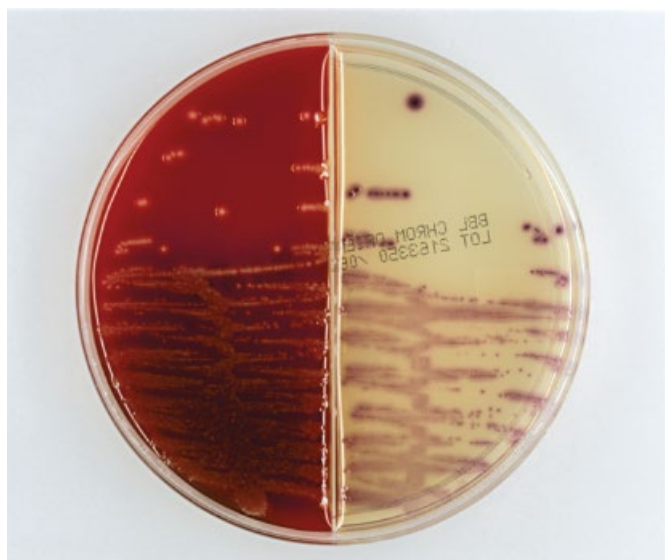
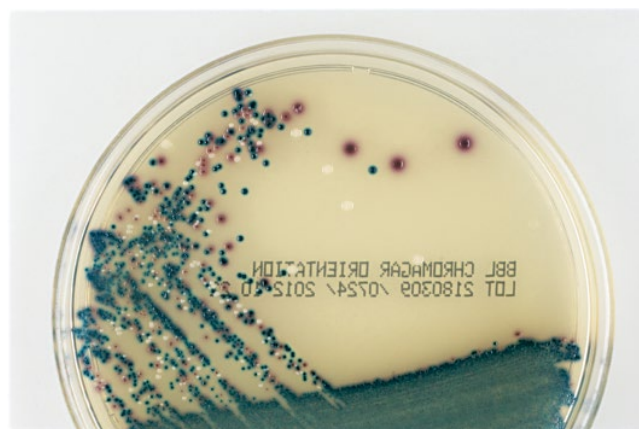


Figure 41-30 Hektoen enteric agar. Hektoen enteric (HE) agar is a selective and differential medium used for the isolation of *Salmonella* spp. and *Shigella* spp. from fecal specimens. The medium contains lactose, sucrose, and salicin. *Salmonella* spp. and *Shigella* spp. do not generally ferment these carbohydrates. Also, differentiation of species occurs with the addition of sodium thiosulfate and ferric ammonium citrate, which allow detection of hydrogen sulfide (H_2S) production. Organisms producing H_2S appear as black colonies. Examples of organisms with specific reactions on HE agar are *E. coli* organisms, which appear as yellow or salmon colored; *Shigella* spp., which are green or transparent; and *Salmonella* spp., which are green or transparent with black centers. Shown here are lactose-positive colonies (yellowish color) and H_2S -producing colonies (black).

Figure 41-31 Eosin methylene blue agar. Eosin methylene blue agar, like MacConkey agar, is moderately inhibitory and was developed to inhibit the growth of Gram-positive organisms and to detect lactose fermentation. Eosin Y and methylene blue are the inhibitors used in this medium. Due to the precipitation of the dye, rapid lactose fermenters such as *E. coli* form colonies with a metallic sheen, as shown here; other strong acid producers can give the same appearance.



Figure 41-32 CHROMagar. CHROMagar products are chromogenic media for the isolation and identification of a variety of microorganisms. The medium has also been referred to as Rambach agar, named after Alain Rambach, the developer. First-generation media were monochromogenic, developed specifically for the detection of *Escherichia coli* and *Salmonella* spp. Second-generation agars are multicolor. BBL CHROMagar Orientation medium (shown here) (BD Diagnostic Systems, Franklin Lakes, NJ) is used to identify potential pathogens of urinary tract infections. The medium was inoculated with *E. coli* (pink colonies), *Enterococcus* sp. (blue/turquoise colonies), and coagulase-negative staphylococci (golden opaque/white colonies).



A



B

Figure 41-33 BBL CHROMagar and BBL Trypticase soy agar with 5% sheep blood (sheep blood agar, SBA). Plates containing BBL CHROMagar and BBL Trypticase soy agar with 5% sheep blood (TSA-II; BD Diagnostic Systems, Franklin Lakes, NJ) are used primarily to isolate and identify microorganisms from urine specimens. (A) It is difficult to determine whether the organism on the SBA (left) is Gram positive or Gram negative; however, based on the color reaction on the CHROMagar medium, the organism is likely *E. coli* (right). (B) A mixed culture is shown on the SBA, and the color reactions on the CHROMagar medium suggest the presence of *E. coli*, *Enterococcus*, and coagulase-negative staphylococci.

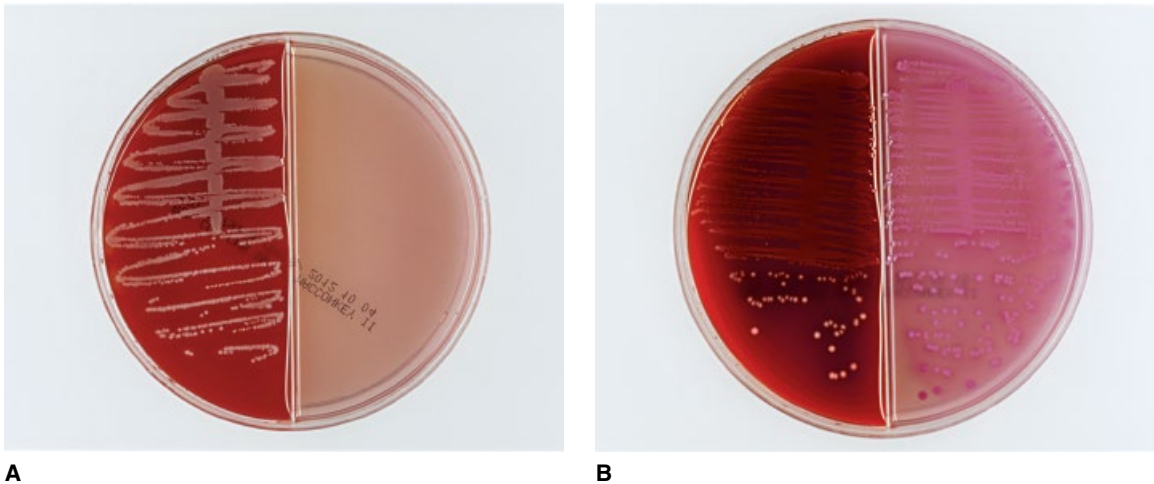


Figure 41-34 Columbia CNA-MacConkey agar biplate. CNA (colistin-nalidixic acid blood agar) is selective for the growth of Gram-positive cocci. The colistin and nalidixic acid in the medium inhibit the growth of Gram-negative bacilli. (A) A Gram-positive organism is growing on the left half of the plate, which contains CNA, and there is no growth on the MacConkey agar side. (B) *Enterococcus* was identified on CNA and *E. coli* on MacConkey agar.



Figure 41-35 Brucella agar with hemin and vitamin K. Brucella agar with hemin and vitamin K is a nonselective, enriched medium used for the isolation of anaerobic bacteria, especially Gram-negative organisms. The medium contains casein peptones, dextrose, and yeast extract. Hemin and vitamin K are added enrichments. Sheep blood provides additional nutrients and is used to detect hemolytic reactions. Shown here are gray colonies of *Bacteroides*.

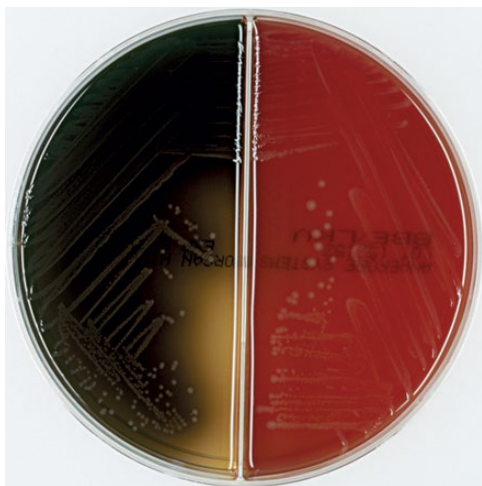


Figure 41-36 Kanamycin–vancomycin–brucella–laked sheep blood agar and bacteroides bile esculin agar. Kanamycin–vancomycin–brucella–laked sheep blood agar is an enriched, selective, and differential medium used for the isolation of anaerobic bacteria, especially *Bacteroides* spp., pigmented, anaerobic, Gram-positive bacilli, and *Prevotella* spp. The blood in the medium is laked, and vitamin K₁ is added to facilitate the recovery of *Prevotella melaninogenica*. Laked blood is defibrinated blood that has been processed with freeze-thaw cycles to hemolyze the red blood cells, allowing the release of many nutrients. The base is CDC anaerobe blood agar, and the selective agents are kanamycin and vancomycin. Kanamycin inhibits the growth of Gram-negative, facultative anaerobic bacilli, and vancomycin inhibits the growth of Gram-positive organisms. *Bacteroides* bile esculin agar is an enriched medium for the isolation of the *Bacteroides fragilis* group. It contains gentamicin, which inhibits most facultative anaerobes. The bile in the medium inhibits anaerobic, Gram-negative bacilli, except the *B. fragilis* group and other bile-resistant, Gram-negative bacilli. Most members of the *Bacteroides* group hydrolyze esculin, and therefore, the esculin in the medium produces a brown-black color around the colonies, as shown on the left side of the biplate, which confirms the identification of the organism grown on the right side of the biplate.

BIOCHEMICAL TESTS

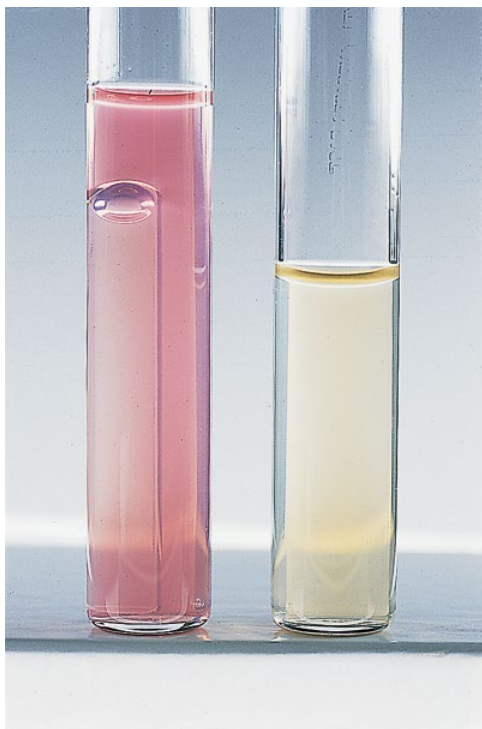


Figure 41-37 Andrade's broth. Andrade's broth supplemented with carbohydrates is used to determine fermentation by bacteria, particularly members of the *Enterobacterales*. The medium contains a sugar-free peptone broth to which a specific carbohydrate is added. A decolorized acid fuchsin is used as the pH indicator. When the organism metabolizes the carbohydrate, the pH of the medium decreases as a result of the acid production and changes the color of the indicator from colorless to pink or red, depending on the amount of acid generated. As shown here, a Durham tube may be inserted to detect the formation of gas (left). As a control, a tube without the added carbohydrate should be inoculated and processed in parallel (right).



Figure 41-38 Bile esculin agar. Bile esculin agar is both a differential and selective medium. This agar is commonly used in plates or, as shown here, slants. It is used for the differentiation of *Enterococcus* spp. and the *Streptococcus bovis* group (group D) from other streptococci. The medium consists of 40% bile (oxgall), which inhibits streptococci other than enterococci or group D streptococci. Enterococci and group D streptococci hydrolyze esculin, resulting in the formation of esculetin and dextrose. They form complexes with ferric citrate in the medium, resulting in a dark brown to black precipitate. Shown here are *Enterococcus faecalis* (left), which is bile esculin positive, and *Streptococcus pyogenes* (right), which is bile esculin negative.



Figure 41-39 Hugh and Leifson carbohydrate oxidative-fermentative medium. The oxidative-fermentative (OF) test was developed by Hugh and Leifson. Bacteria can degrade glucose by the anaerobic pathway (also called the glycolytic or fermentative pathway), producing strong acids that can easily be detected with regular media, or by the aerobic (oxidative) pathway, producing weak acids that can be detected using OF medium. This medium has three unique characteristics: (i) a low (0.2%) concentration of peptone, thus preventing the formation of alkaline products that may neutralize small quantities of acids; (ii) a high (1.0%) concentration of carbohydrates, which allows large amounts of acid to be formed; and (iii) a low (0.3%) concentration of agar, which results in a semisolid medium that permits acids formed on the surface to permeate the medium. Two tubes are used for the test. Both tubes are inoculated with the unknown organism by using a straight needle and are incubated at 35°C for several days. One is covered with melted paraffin or mineral oil, which prevents oxygen from entering the medium. A color change from green to yellow in both tubes (shown in the second and fourth tubes from the left) indicates that the organism is fermentative, since it can produce acid without oxygen. A green to yellow color in the uncovered tube (second tube), but not in the tube with mineral oil (third tube), means that the organism is oxidative, since it requires oxygen to metabolize the carbohydrates. If both tubes remain green (first and third tubes), the organism is asaccharolytic.



Figure 41-40 Catalase test. The rapid catalase test uses a solution of 3% hydrogen peroxide to determine whether a microorganism contains the enzyme catalase. Microorganisms are added to a drop of 3% hydrogen peroxide. If catalase is present, bubbles appear as a result of the release of O_2 from the breakdown of the hydrogen peroxide by the enzyme.

Figure 41-41 Citrate utilization. Some microorganisms utilize sodium citrate as the sole carbon source. Therefore, the medium used to detect citrate utilization cannot contain proteins or carbohydrates as the source of carbon. The medium includes sodium citrate as the sole source of carbon and ammonium phosphate as the only source of nitrogen. By utilizing the nitrogen from the ammonium phosphate, bacteria that use the citrate will excrete ammonia, leading to the alkalization of the medium. Bromthymol blue is used as the indicator. This characteristic helps in the identification of several members of the *Enterobacteriales*. The negative slant is on the left, and the positive blue slant is on the right.

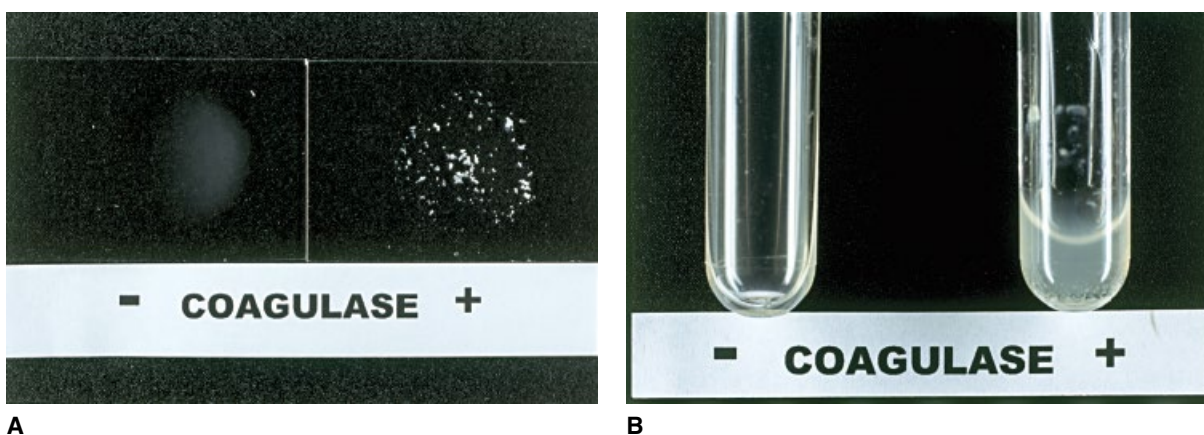


Figure 41-42 Coagulase slide and tube test. The coagulase test is widely used for differentiating *Staphylococcus aureus* from most other *Staphylococcus* spp. Most *S. aureus* strains produce two forms of coagulase, free and bound. Bound coagulase, or clumping factor, is bound to the bacterial cell wall and reacts directly with fibrinogen. The fibrinogen precipitates on the staphylococcal cell, causing the organisms to clump when the bacterial suspension is mixed with rabbit plasma. The slide coagulase test is positive in the presence of bound coagulase, whereas the tube coagulase test measures free coagulase. In most cases, the presence of bound coagulase correlates well with free coagulase. However, some *S. aureus* strains produce only free coagulase. Also, *Staphylococcus lugdunensis* and *Staphylococcus schleiferi* have only bound coagulase and therefore are slide coagulase positive but tube coagulase negative. (A) Slide coagulase test. In the slide coagulase test, there is no clumping on the left side (negative test), whereas clumping of cells suspended in rabbit plasma is observed on the right side of the slide (positive test). (B) Tube coagulase test. The tube on the left shows a negative reaction, since the plasma remains liquid, whereas a clot is observed in the tube on the right, indicating a positive test. The tube should be read after a 4-h incubation for clot formation and reincubated for up to 24 h if negative. It is important to note that once a clot is formed, it can dissolve after 4 h, so if the result is not noted within that time, a false-negative result may be reported.



Figure 41-43 Cystine Trypticase agar carbohydrates. The utilization of carbohydrates by bacteria can be detected using cystine Trypticase agar containing maltose, sucrose, lactose, and glucose, with phenol red as the pH indicator. A positive reaction is indicated by a yellow color, which occurs when the pH drops below 6.8 as a result of the oxidation of the carbohydrate. Shown is an isolate of *Neisseria gonorrhoeae* that exhibits a typical pattern of oxidation of glucose but negative maltose, lactose, and sucrose oxidation (left to right).



Figure 41-44 Decarboxylase-dihydrolase test. The decarboxylase-dihydrolase test is based on the principle that certain organisms remove a carboxy or hydroxyl group (hydrolyze) from an amino acid to form an amine, resulting in an alkaline pH. The test medium contains both glucose and one of the amino acids lysine, ornithine, and arginine. Under anaerobic conditions, certain organisms can ferment glucose, resulting in a decrease in pH, which is detected by a change in color from violet to yellow. The low pH activates the decarboxylase that converts the lysine to cadaverine and converts the ornithine to putrescine. Arginine is first converted to citrulline by a dihydrolase. Citrulline is then converted to ornithine, which is decarboxylated to putrescine. The formation of alkaline amines increases the pH, and the medium returns to a violet color. An alkaline reaction in the medium containing the amino acid is interpreted as a positive test (left tube), whereas an acidic reaction is considered negative (right tube).



Figure 41-45 DNase test. The DNase test can be used to differentiate between certain groups of microorganisms. In this test, the presence of DNase is assessed by its ability to digest DNA, producing oligonucleotides. A common method of testing for DNase is to inoculate the isolate onto an agar plate that incorporates DNA and the metachromatic dye toluidine blue. If DNase is not present, the area surrounding the bacterial growth remains unchanged. However, when the DNA is hydrolyzed by DNase, the resulting oligonucleotides form a complex with the toluidine blue, resulting in metachromatic (pink) staining. In the example shown, *Moraxella catarrhalis* is DNase positive (pink halo, left), whereas the other organism shown is negative for DNase, since there is no change in the original blue color of the medium (right).



Figure 41-46 Gelatin hydrolysis test. Gelatin is incorporated into various media to detect the presence of the proteolytic enzyme gelatinase, which hydrolyzes gelatin into its constituent amino acids, with the subsequent loss of its gelling characteristic. The use of exposed, undeveloped X-ray film is one method to test for the presence of the enzyme. When hydrolysis occurs, the film loses its gelatin coating, resulting in a clear, bluish photographic film (left tube).

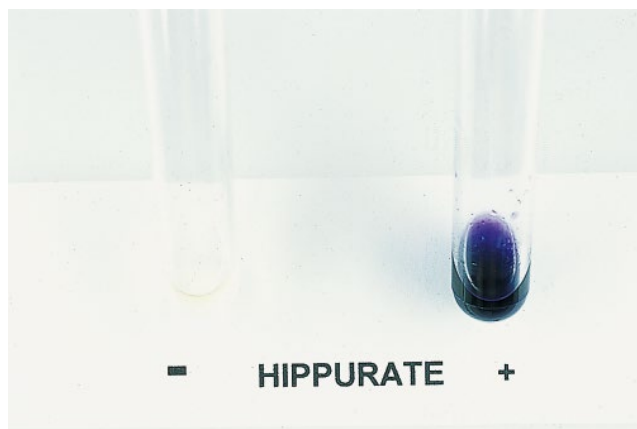
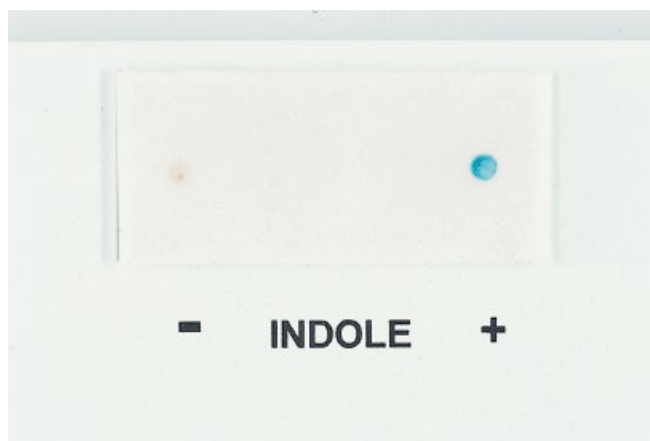


Figure 41-47 Hippurate hydrolysis test. The hippurate hydrolysis test detects hippuricase; this reaction can be used to differentiate between groups of streptococci as well as *Gardnerella vaginalis* and *Campylobacter jejuni*. Hippuric acid is hydrolyzed by hippuricase to form glycine and sodium benzoate. In the hippurate test shown, a heavy suspension of organisms is made in a 1% aqueous hippurate solution and incubated for 2 h at 37°C. A negative test is indicated by no color change when ninhydrin is added (left). However, a positive test occurs when the added ninhydrin complexes with glycine and produces a purple color (right).



A



B

Figure 41-48 Indole test. Some organisms possess the enzyme tryptophanase, which converts tryptophan to indole. Indole is detected by the addition of *p*-dimethylaminobenzaldehyde (Ehrlich's or Kovac's reagent) to a broth solution (tube test). (A) If a ring of red appears at the interface between the top of the broth and the reagent, the test is positive (left); a negative test is shown on the right. (B) Alternatively, when filter paper impregnated with *p*-dimethylcinnamaldehyde is used, a negative reaction (left) is colorless, whereas the formation of a green color indicates a positive test (right).

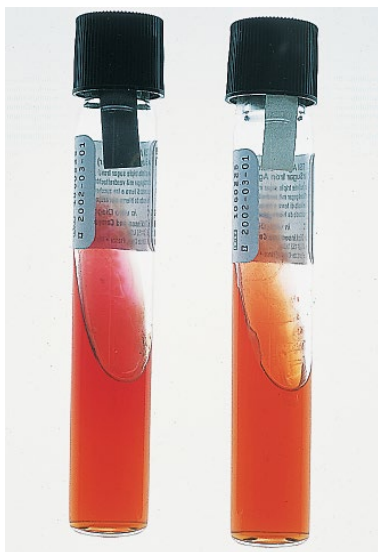


Figure 41-49 Lead acetate test. Certain organisms are capable of enzymatically liberating sulfur from sulfur-containing amino acids or other compounds. The hydrogen sulfide gas released can then react with ferric ions or lead acetate to yield a black precipitate, i.e., ferrous sulfide or lead acetate. The sensitivities of the indicators vary. Lead acetate is the most sensitive indicator and should be used for organisms that produce trace amounts of H_2S . A positive lead acetate test is indicated by brownish-black coloration of the paper strip (left tube).



Figure 41-51 Motility test. Some organisms can be differentiated based on motility. An agar deep, containing tryptose and the dye triphenyltetrazolium chloride, is inoculated with a microorganism and incubated at $35^\circ C$ overnight. Motile bacteria migrate from the original inoculation site or stab line. This migration is visualized with the aid of triphenyltetrazolium chloride, which is incorporated into the bacterial cells and is reduced to form an insoluble red pigment (formazan). In the example shown here, the nonmotile organism is on the left and the motile organism is on the right.



Figure 41-50 Methyl red test. When glucose is metabolized through the mixed-acid fermentation pathway, strong acids such as lactic acid, acetic acid, and formic acid are produced, resulting in a decrease of pH below 4.5. At this pH, the broth turns red (left tube) upon addition of methyl red.



Figure 41-52 Nitrate test. Certain bacteria reduce nitrates to nitrites. Adding α -naphthylamine and sulfanilic acid to the nitrate tube results in the formation of *p*-sulfo benzene-azo- α -naphthylamine, a red diazonium dye, which indicates that nitrates have been reduced to nitrites (left tube). A negative result indicates either that no nitrites are present or that nitrates have been reduced to other compounds such as ammonia, molecular nitrogen, nitric oxide, or nitrous oxide (right tube). To determine if a colorless broth is truly negative or if the nitrates have been reduced to products other than nitrites, zinc dust is added to the colorless tube. Zinc reduces nitrate to nitrite and produces a red color. Thus, if the broth turns red when zinc is added, the test is interpreted as negative (middle tube). If the broth remains colorless, the nitrates have been reduced to other products (right tube).

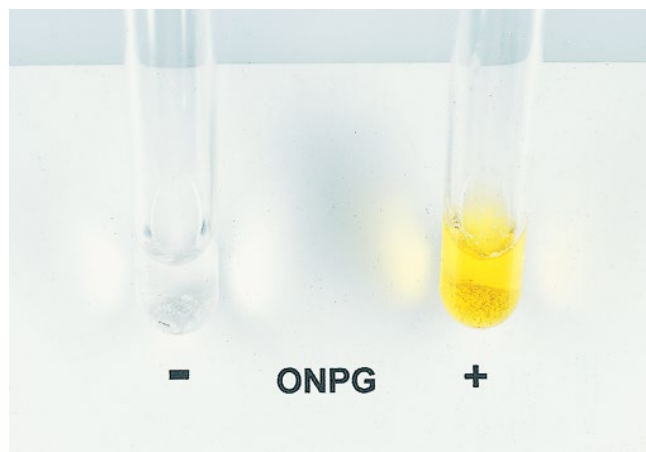


Figure 41-53 *o*-Nitrophenyl- β -D-galactopyranoside test. Late lactose fermenters are very difficult to distinguish from lactose nonfermenters because both appear as colorless colonies on MacConkey agar. The *o*-nitrophenyl- β -D-galactopyranoside (ONPG) test is used to detect the enzyme β -galactosidase, present in late lactose fermenters. If no color change occurs, the organism does not contain β -galactosidase (left tube). Organisms that produce this enzyme hydrolyze the substrate ONPG, and orthonitrophenol is formed (right tube). Orthonitrophenol is yellow in its free form and colorless when bound to D-galactopyranoside. It should be noted that the ONPG test detects β -galactosidase activity only and cannot be equated with determination of lactose fermentation, which is also dependent on the enzyme permease.



Figure 41-55 Phenylalanine deaminase test. Amino acids can be oxidatively deaminated to form a keto acid. In the presence of phenylalanine deaminase (PAD), the amino acid L-phenylalanine is converted to phenylpyruvic acid, a keto acid. If the slant remains colorless upon the addition of 10% ferric chloride, the test is negative (left). However, if the slant turns green, the test is positive (right). *Proteus* spp., *Providencia* spp., and *Morganella* spp. are PAD positive.

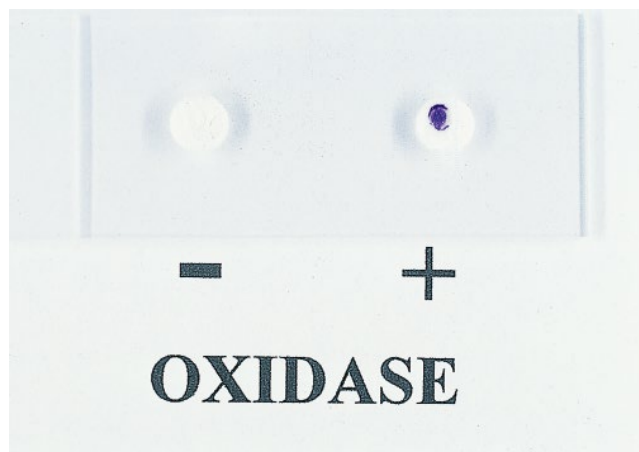


Figure 41-54 Oxidase test. Certain bacteria possess either cytochrome oxidase or indophenol oxidase, which catalyzes the transport of electrons (hydrogen) from donor compounds (NADH) to electron acceptors (usually oxygen) with the formation of water. In the presence of atmospheric oxygen and cytochrome oxidase, a colorless dye such as 1% tetramethyl-*p*-phenylenediamine dihydrochloride (Kovac's reagent) is oxidized and forms indophenol blue. This test can easily be performed directly by applying Kovac's reagent onto the colonies or indirectly by rubbing the colonies onto filter paper moistened with the reagent. If colonies rubbed onto filter paper moistened with the reagent remain colorless, the organism is oxidase negative (left). However, if the colonies turn dark blue or purple within 10 to 30 s, the test is positive (right).



Figure 41-56 L-Pyrrolidonyl- β -naphthylamide test. The L-pyrrolidonyl- β -naphthylamide (PYR) test is commonly used to identify *Streptococcus pyogenes* and *Enterococcus* spp., which are PYR positive. In this test, the enzyme L-pyrrolidonyl arylamidase hydrolyzes the substrate PYR, resulting in the formation of a free β -naphthylamine. Subsequently, this by-product is detected with *N,N*-methyl-aminocinnamaldehyde, resulting in a bright red color. The figure shows negative (*Streptococcus agalactiae*, left) and positive (*S. pyogenes*, right) reactions.



Figure 41-57 Triple sugar iron agar. Triple sugar iron (TSI) agar slants contain three carbohydrates—glucose, lactose, and sucrose—at a ratio of 10:10:1. For the detection of H₂S, sodium thiosulfate is present in the medium as the source of sulfur atoms. Two iron salts, ferrous sulfate and ferric ammonium citrate, react with the H₂S to form a black ferrous sulfide precipitate. In the TSI tube, half of the length of the agar is at a slant and thus is aerobic due to the exposure to oxygen, while the butt is protected from air and as a result is considered anaerobic. Production of the gases CO₂ and H₂ is also detected by observing cracks or bubbles in the agar. The tubes should be inoculated with a single, well-isolated colony by using a long, straight wire. No change in the medium (alkaline/alkaline [Alk/Alk]) indicates that the organism cannot ferment any of the sugars present, thereby excluding the *Enterobacteriales*. If glucose alone is fermented, the bottom (butt) portion of the slant will be yellow due to the acid production by the fermentation of glucose under anaerobic conditions; however, the top (slant) portion will be alkaline (pink) due to the oxidative degradation of the peptones under aerobic conditions (alkaline/acid [Alk/A]). Fermentation of glucose and lactose or of sucrose results in both an acidic slant and an acidic butt (A/A) due to the increased amount of acid produced compared to the fermentation of glucose alone. As shown in this figure, members of the *Enterobacteriales* demonstrate a variety of reactions. Because they all ferment glucose, the butt will always be acidic (yellow) if not masked by H₂S production (black). Table 10-3 lists the possible organisms associated with these reactions. The TSI slants shown in this figure (left to right) are as follows (“gas” indicates that the agar lifted slightly from the bottom of the tube).

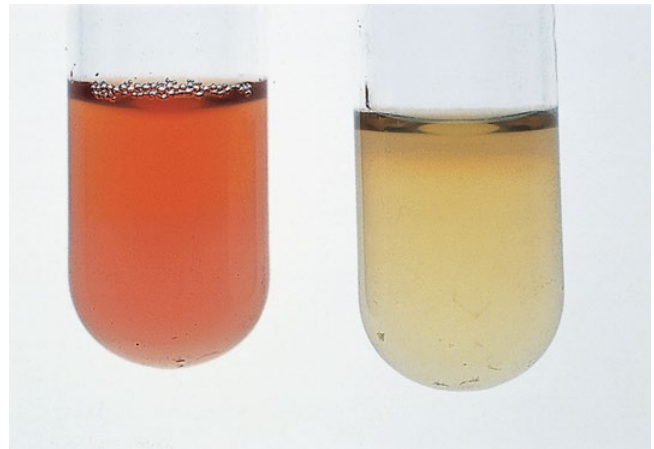
Slant 1	Slant 2	Slant 3	Slant 4	Slant 5	Slant 6	Slant 7
A/A, gas	A/A, H ₂ S	Alk/A, gas	Alk/A	A/A	A/A, slight H ₂ S	A/A, gas, H ₂ S

An alternative to the TSI system is Kligler iron agar, which does not contain sucrose. The advantage of sucrose in TSI is that *Salmonella* spp. and *Shigella* spp. do not metabolize either lactose or sucrose. Thus, any acid-acid reaction on a TSI slant excludes *Salmonella* spp. and *Shigella* spp. *Yersinia enterocolitica* ferments sucrose but not lactose, giving an A/A result in TSI and an Alk/A result in Kligler iron agar.

Figure 41-58 Urease test. Organisms that possess the enzyme urease hydrolyze urea, resulting in the production of ammonia and CO_2 , forming ammonium carbonate, an alkaline end product (pH 8.1). This test contains phenol red as an indicator. The test on the left is negative in that the color of the medium is unchanged. However, the test on the right, where the color changed from a tan to cerise or bright pink, is positive due to the hydrolysis of urea.



Figure 41-59 Voges-Proskauer (VP) test. Similar to the methyl red test, the VP test is performed to determine the end product of glucose fermentation. The VP test is considered positive when the carbohydrate is converted through fermentation to acetyl methyl carbinol (acetoin), which is further converted to diacetyl. Upon addition of 5% α -naphthol and 40% KOH, diacetyl forms a red complex (left), which contrasts with no color change (right tube). Various reactions are shown in Table 10-1.



HISTOPATHOLOGY

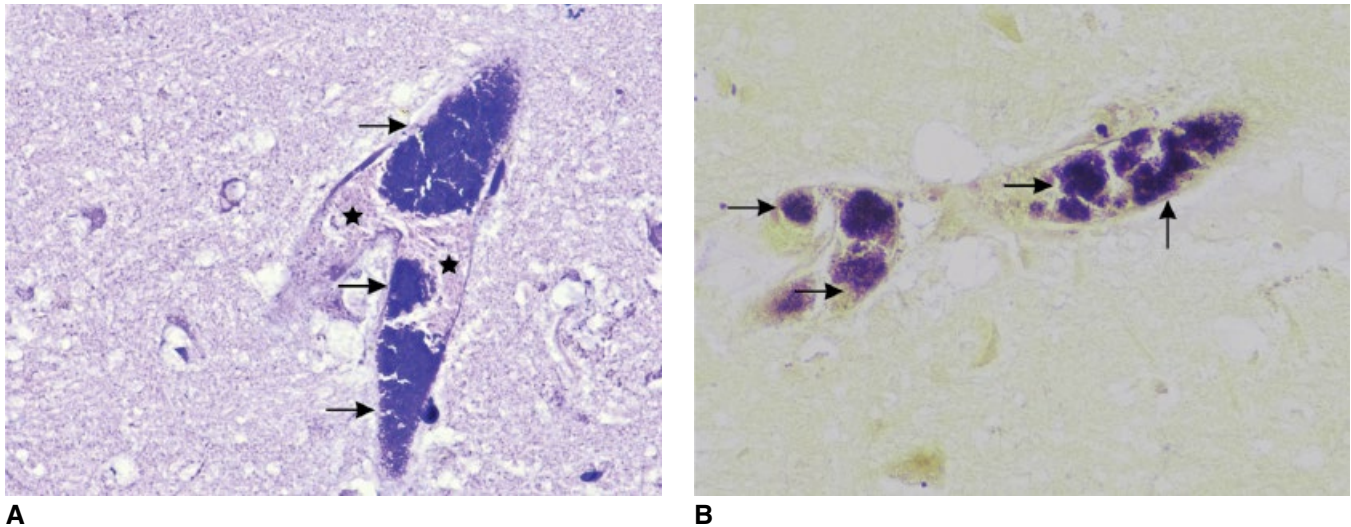


Figure 41-60 Septic cerebral embolism. (A) Brain section stained with H&E (objective magnification, ×50) showing intravascular (stars) bacterial emboli (arrows) from a patient who died of *Staphylococcus aureus* bacteremia. (B) Modified Brown and Hoppps (objective magnification, ×40) of the same tissue shows intravascular Gram-positive cocci in clusters (arrows).

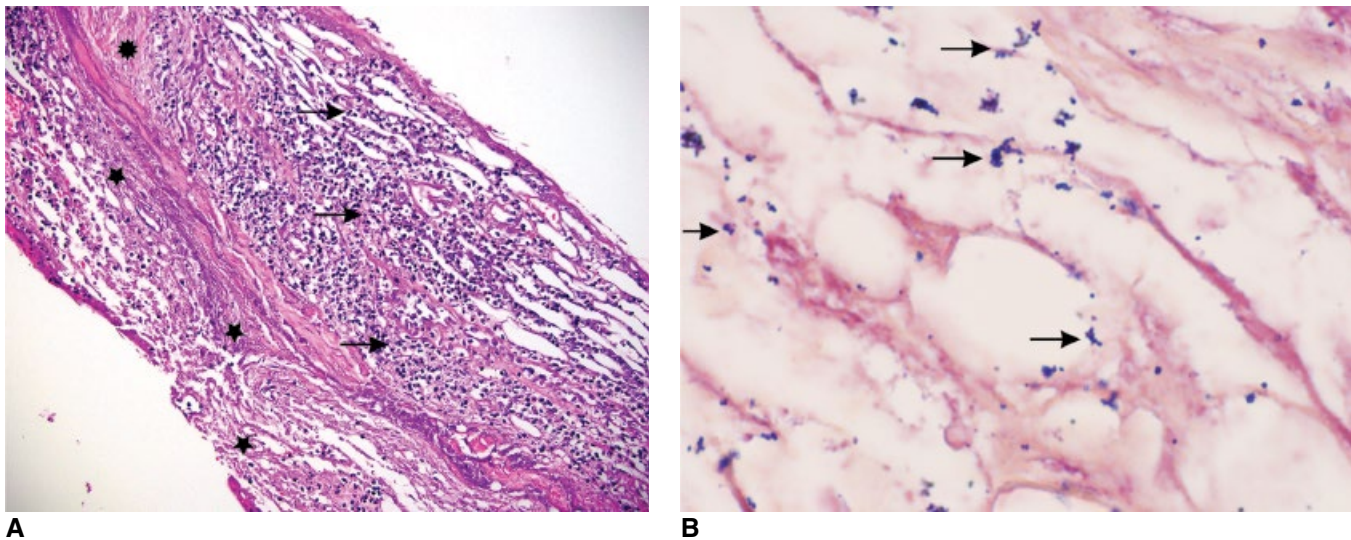


Figure 41-61 Orbital cellulitis. (A) Orbit biopsy stained with H&E (objective magnification, ×20) showing abundant mixed inflammatory cells (arrows) and necrosis (stars). (B) Modified Brown and Hoppps staining (objective magnification, ×100) demonstrates Gram-positive cocci (arrows). The biopsy culture grew *Streptococcus anginosus* group and *Streptococcus mitis-Streptococcus oralis*.

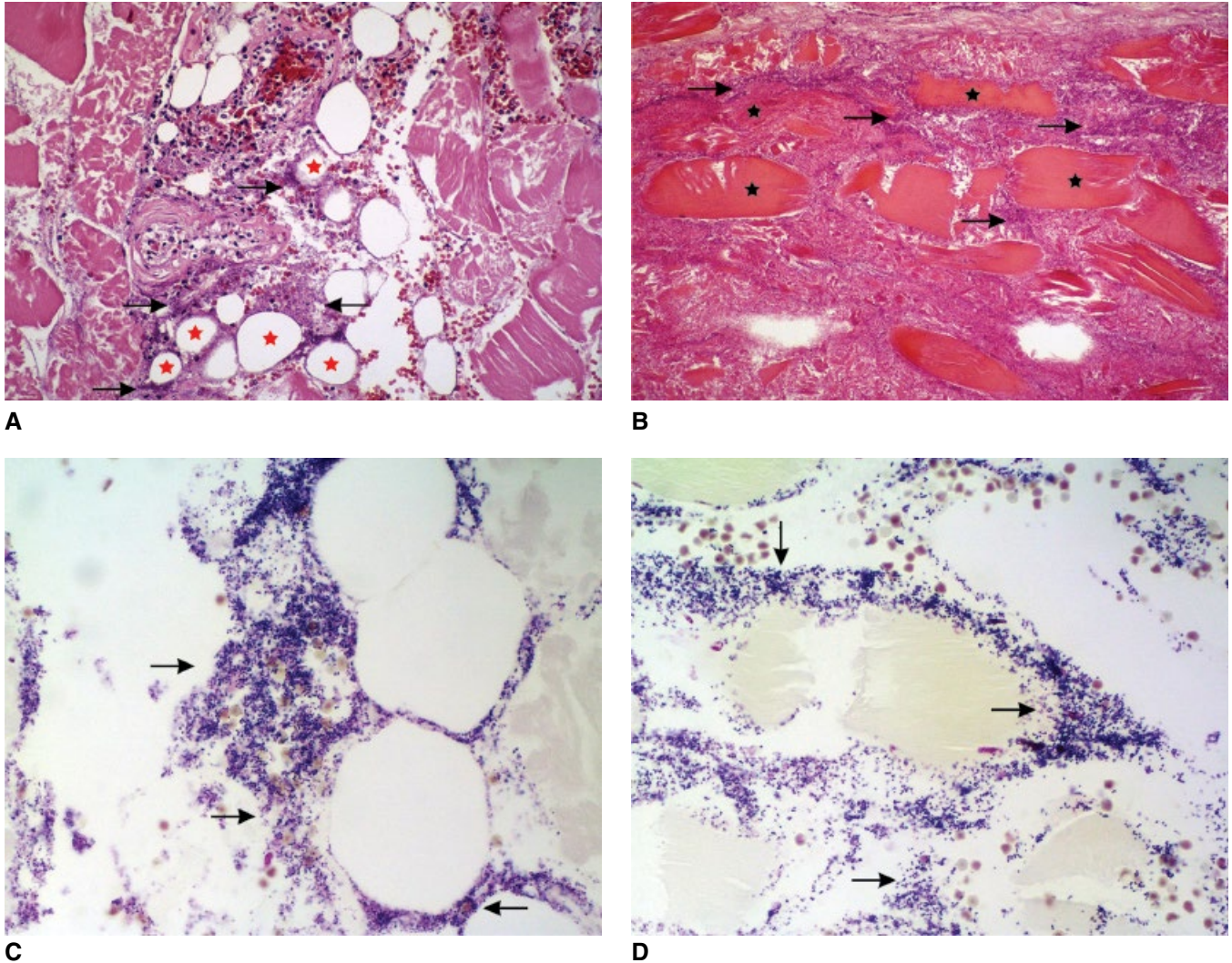
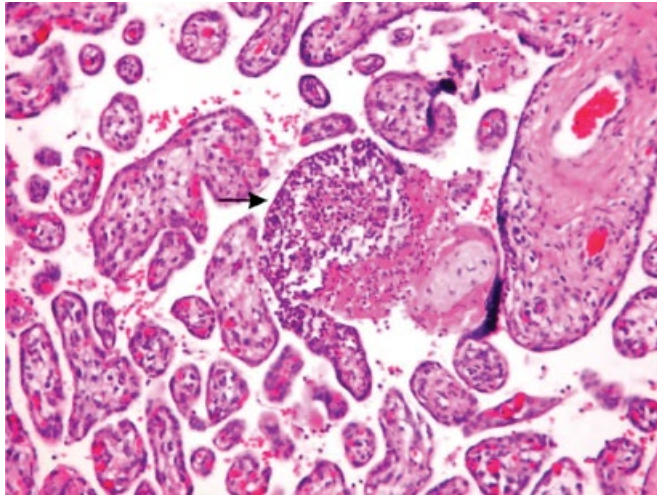
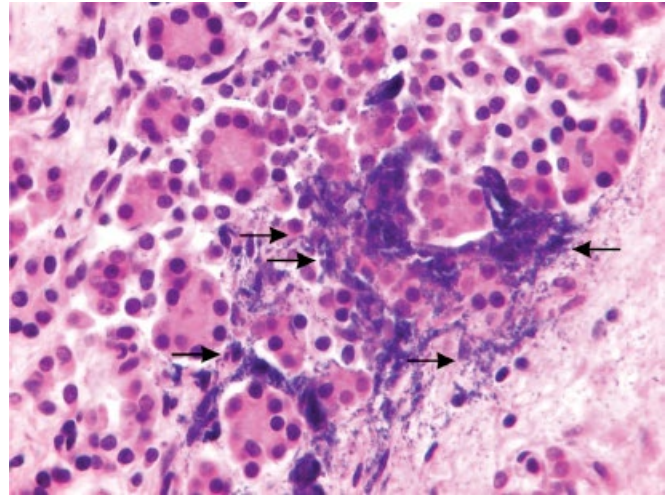


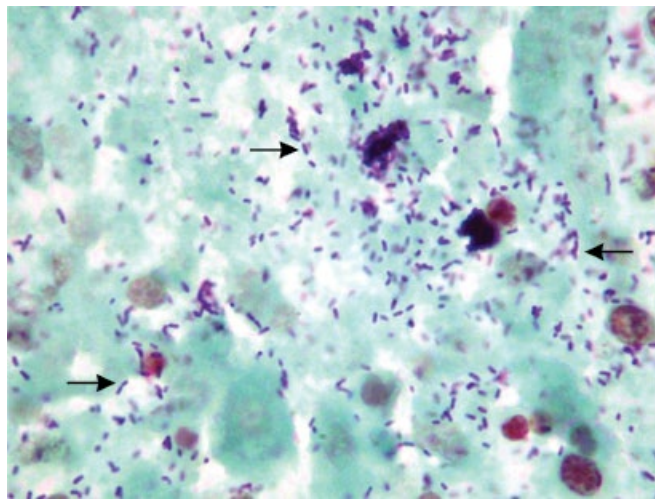
Figure 41-62 Streptococcal toxic-shock syndrome with necrotizing fasciitis. (A and B) Tissue sections showing deep-seated infection involving the subcutaneous tissue (red stars) and muscle (black stars) with numerous bacteria (arrows) seen by H&E staining (objective magnification, $\times 20$). (C and D) Brown and Hopps staining (objective magnification, $\times 40$) of the same material reveals Gram-positive cocci (arrows), which were identified as *Streptococcus pyogenes* by culture.



A



B



C

Figure 41-63 Maternal-fetal listeriosis. (A) The placenta section stained with H&E (objective magnification, $\times 40$) shows acute villitis (arrow) with a microabscess containing neutrophils. (B) A section of pancreas also stained with H&E (objective magnification, $\times 40$) from the fetal autopsy contains numerous bacteria (arrows). (C) Brown and Hopps staining (objective magnification, $\times 100$) of the fetal pancreas reveals Gram-positive bacilli (arrows).

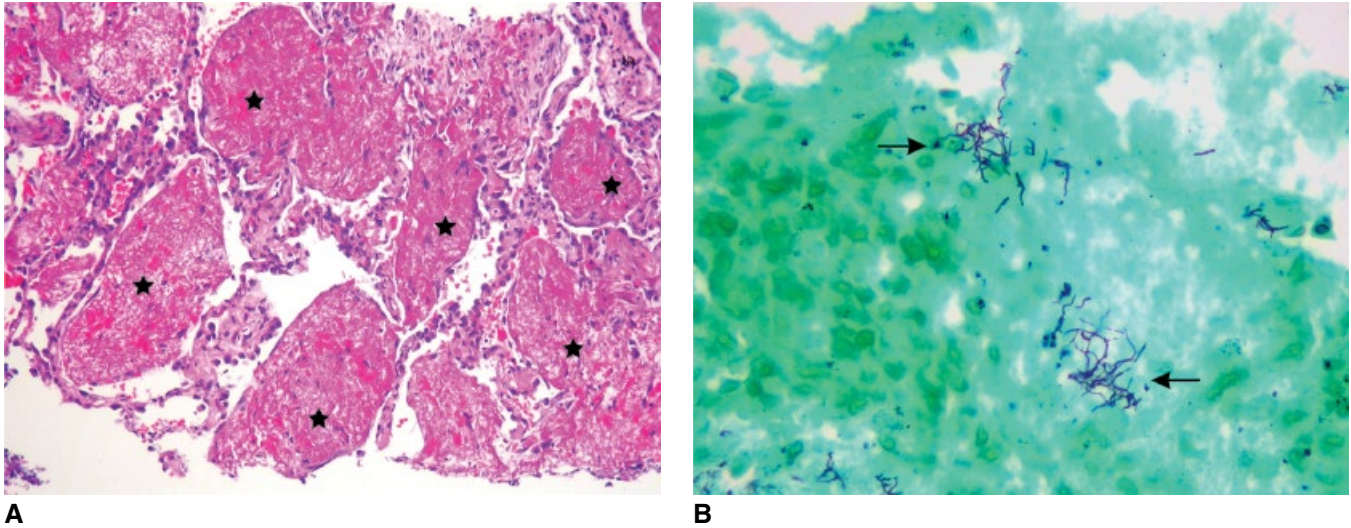


Figure 41-64 Pulmonary nocardiosis. (A) A lung section shows acute fibrinoid organizing pneumonia (stars); organisms are not appreciated on routine H&E staining (objective magnification, $\times 10$). (B) The filamentous bacteria (arrows) are visualized upon Grocott methenamine silver staining (objective magnification, $\times 50$).

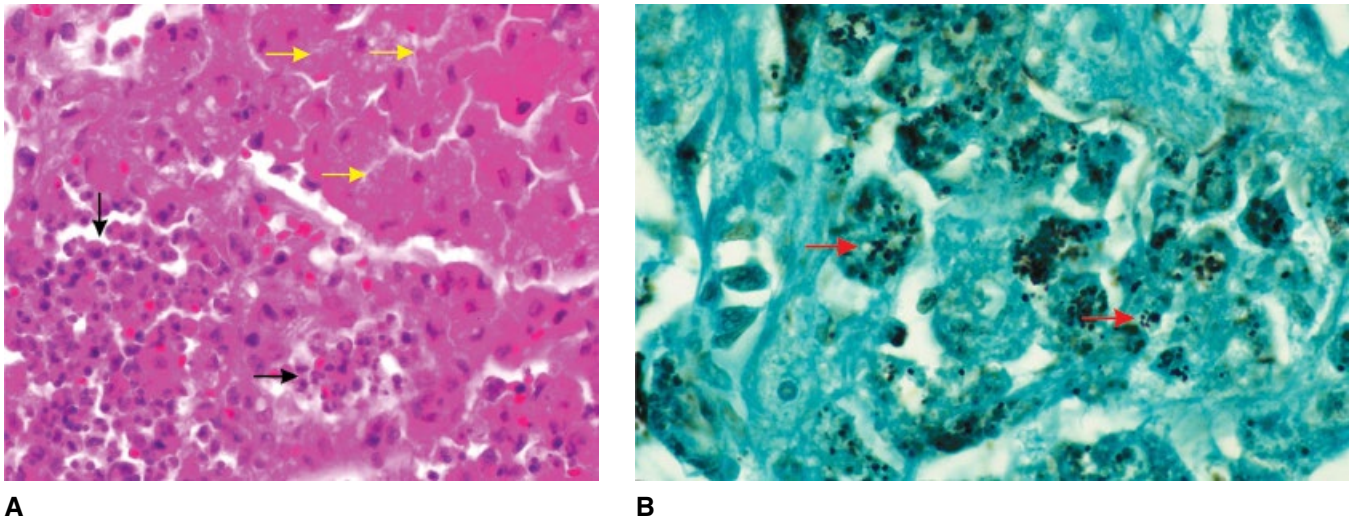
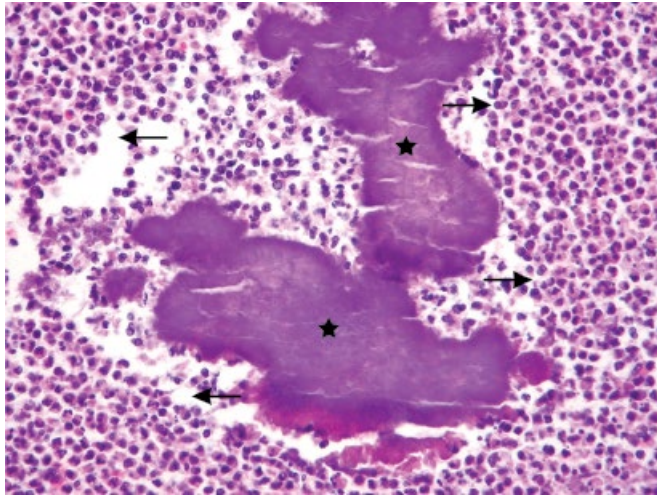
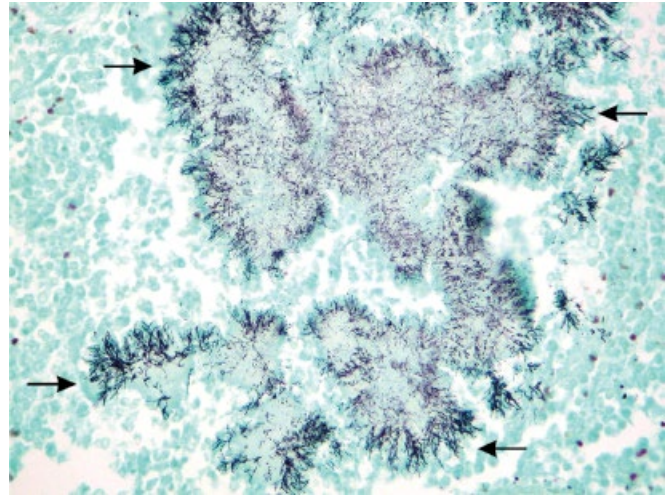


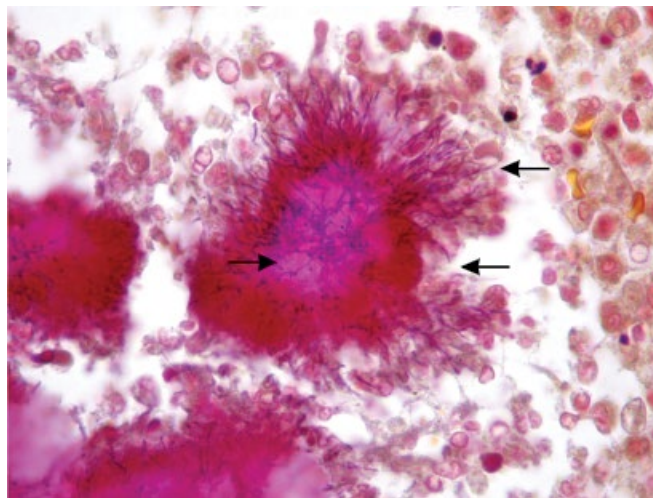
Figure 41-65 *Rhodococcus* pulmonary infection. (A) H&E stain (objective magnification, $\times 40$) shows mixed inflammatory exudate (black arrows) dominated by macrophages with granular eosinophilic foamy cytoplasm (yellow arrows). (B) Grocott methenamine silver stain (objective magnification, $\times 50$) highlights numerous coccobacilli (red arrows).



A



B



C

Figure 41-66 Pulmonary actinomycosis. (A) Lung section stained with H&E (objective magnification, $\times 40$) showing acute inflammation (arrows) with clumped colonies of bacteria known as sulfur granules (stars). (B) Grocott methenamine silver stain (objective magnification, $\times 40$) highlights the filamentous bacteria (arrows). (C) Brown and Hopps stain (objective magnification, $\times 100$) reveals Gram-positive filamentous bacilli (arrows).

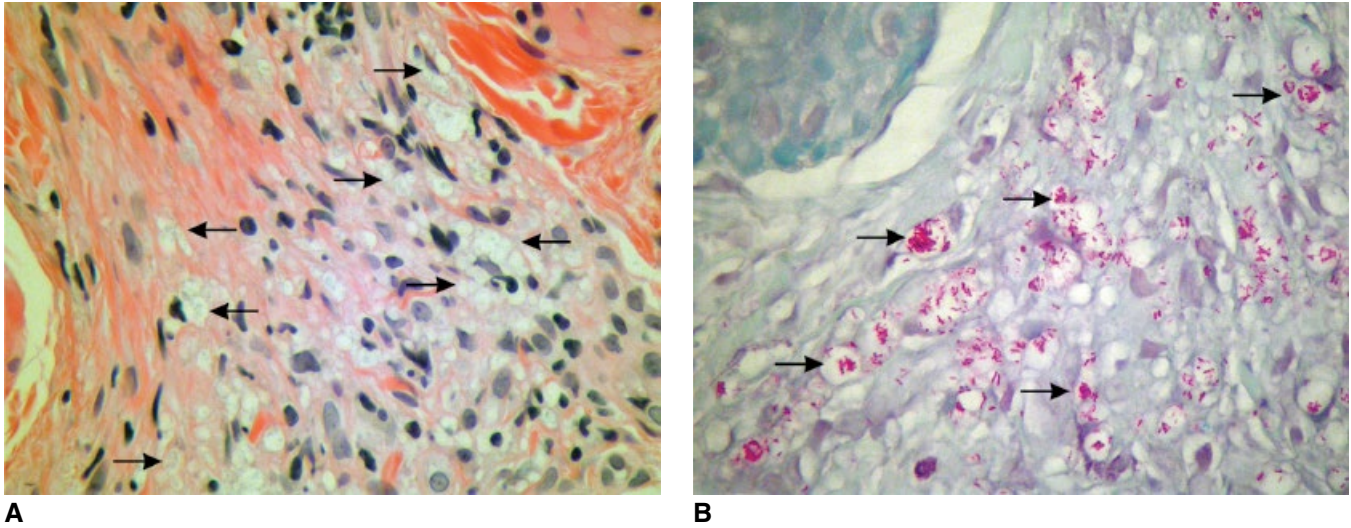
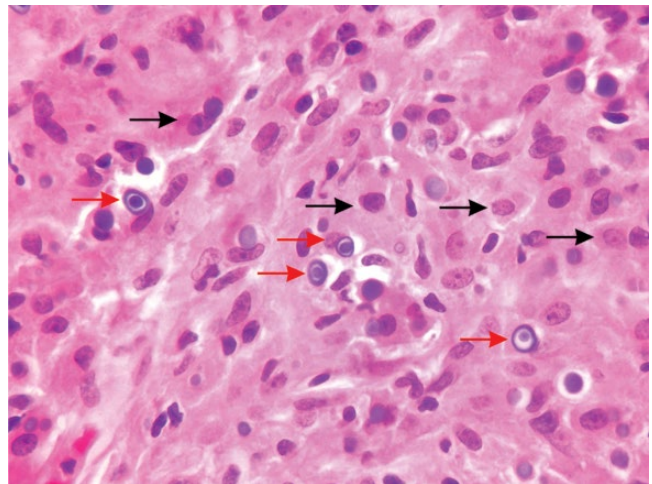
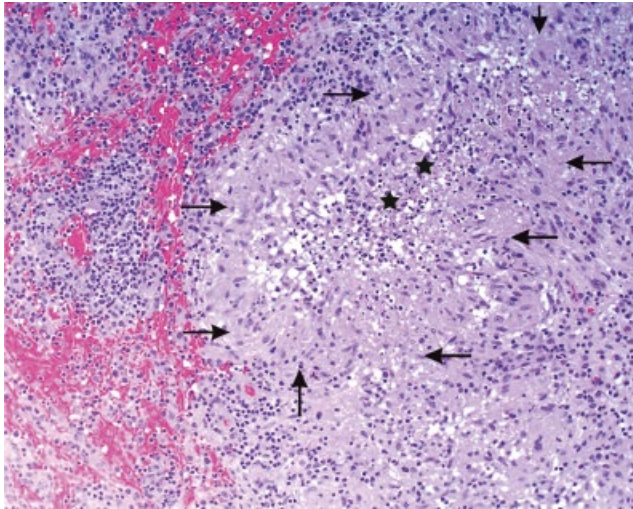


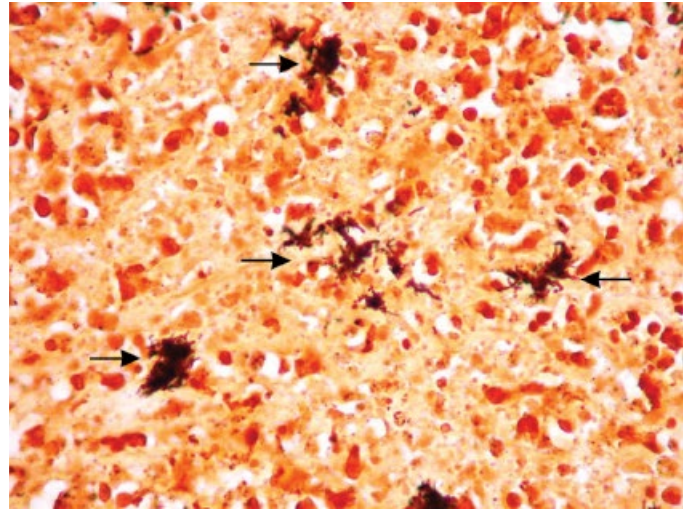
Figure 41-67 Lepromatous leprosy caused by *Mycobacterium leprae*. (A) Skin section stained with H&E stain (objective magnification, $\times 40$) showing lymphohistiocytic infiltrate with foamy macrophages (arrows). (B) Fite stain (objective magnification, $\times 40$) of the same tissue shows sheets of macrophages filled with numerous acid-fast bacilli (arrows).

Figure 41-68 Malakoplakia. Malakoplakia is a rare granulomatous disorder of infectious etiology (especially *Escherichia coli*) that involves the skin and other organs (particularly the bladder). This image is from a bladder section stained with H&E (objective magnification, $\times 40$) showing sheets of histocytes with eccentric nuclei and granular eosinophilic cytoplasm known as von Hansemann cells (black arrows). Targetoid intracytoplasmic inclusions known as Michaelis-Gutmann bodies (undigested bacteria) are present (red arrows).





A



B

Figure 41-69 Cat scratch diseases caused by *Bartonella henselae*. (A) Lymph node biopsy stained with H&E (objective magnification, $\times 20$) shows stellate necrosis (stars) surrounded by palisading histocytes (arrows). (B) Warthin-Starry stain (objective magnification, $\times 50$) demonstrates clusters of pleomorphic bacilli (arrows).

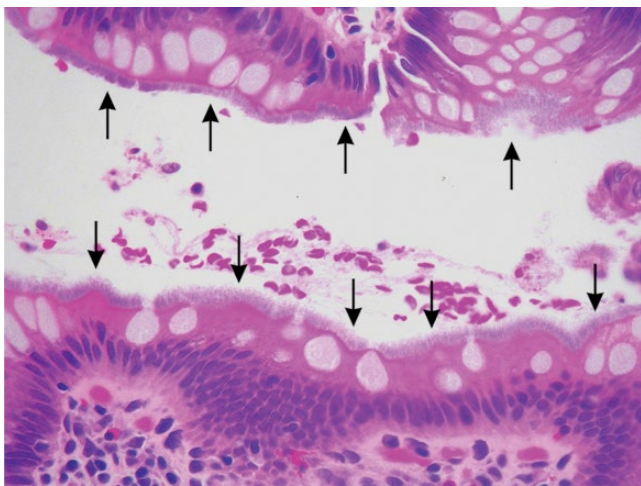


Figure 41-70 Intestinal spirochetosis (*Brachyspira* spp.). An intestinal section stained with H&E (objective magnification, $\times 40$) shows a fringe-like basophilic layer (arrows) along the surface epithelium. This finding is referred to as a false brush border.

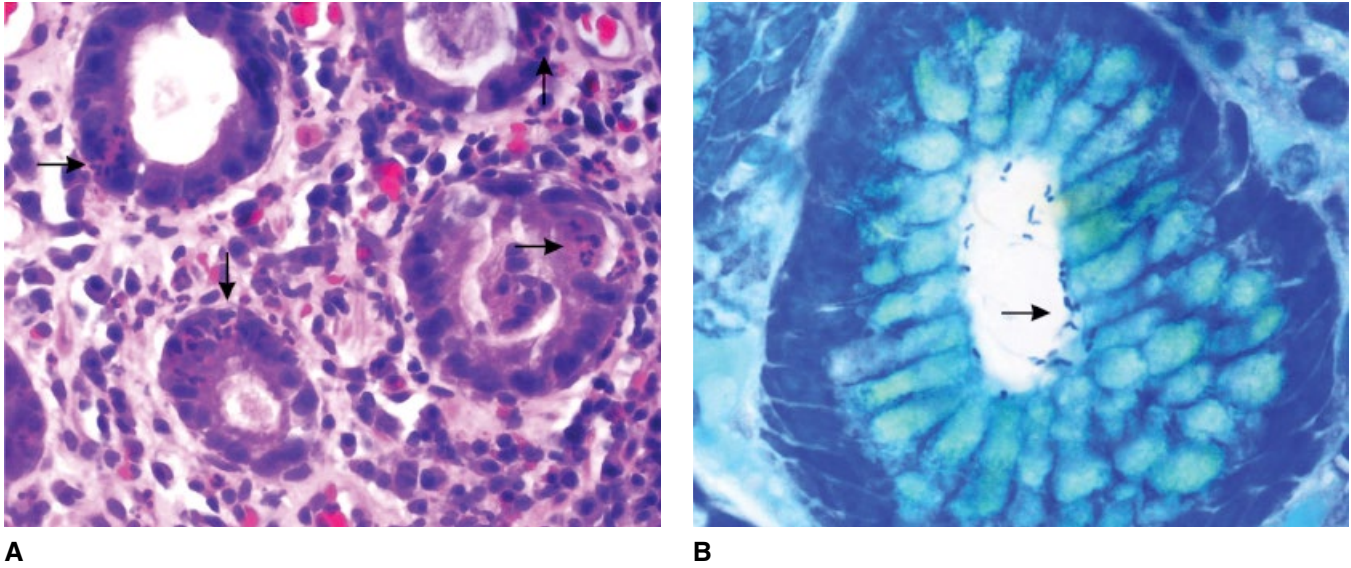


Figure 41-71 *Helicobacter pylori* gastritis. (A) Gastric biopsy section stained with H&E (objective magnification, $\times 40$) shows intraepithelial neutrophils (arrows) indicative of active *H. pylori* gastritis. (B) A Giemsa stain (objective magnification, $\times 100$) highlights slender, curved bacilli (arrows) lining the gastric glands.

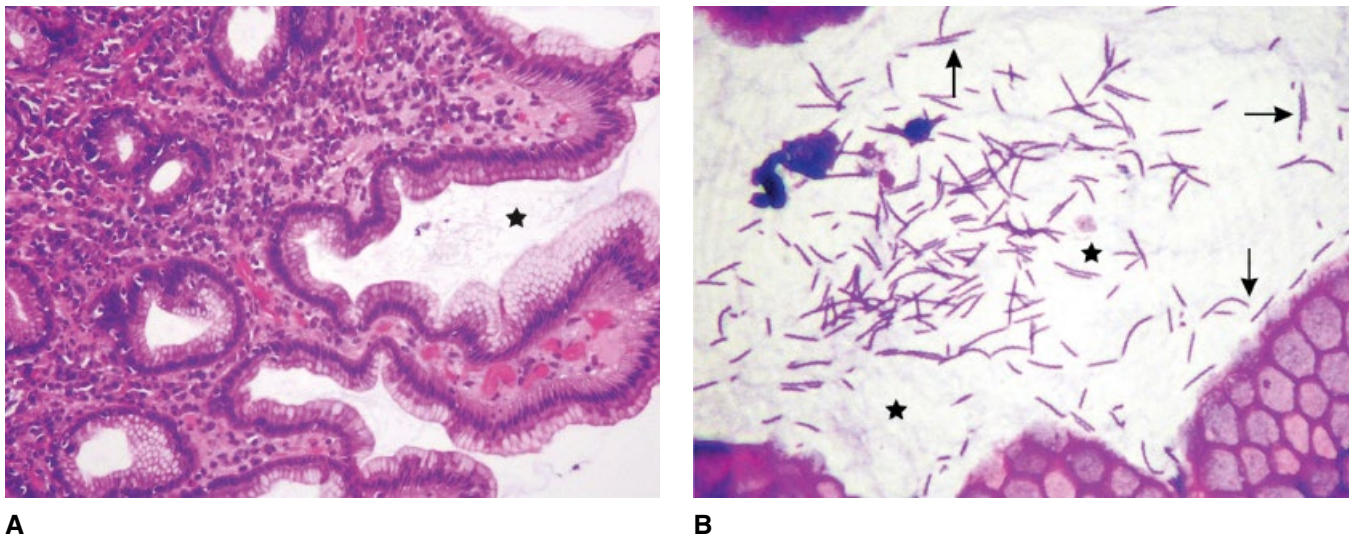
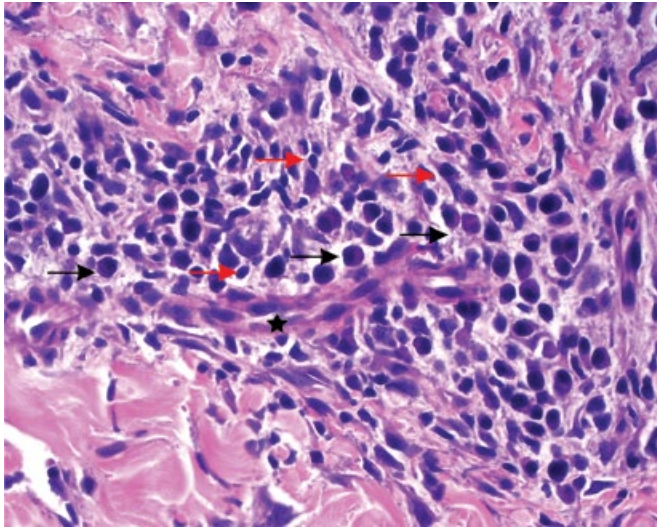
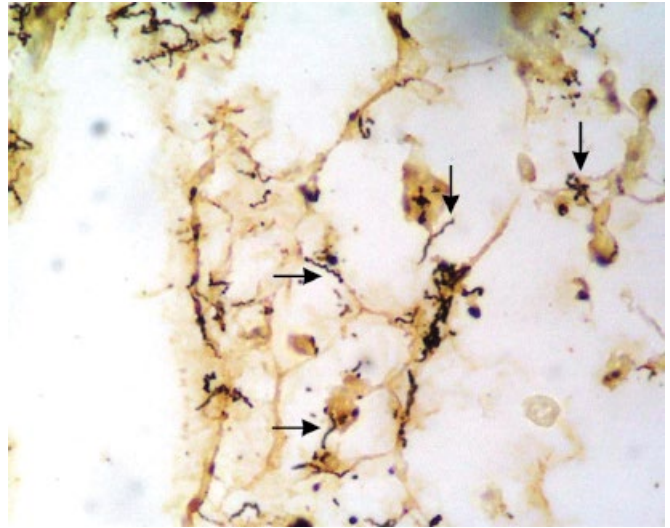


Figure 41-72 *Helicobacter heilmannii*. (A) A gastric biopsy specimen stained with H&E stain (objective magnification, $\times 10$) shows diffuse chronic inflammation in lamina propria with numerous bacteria along the epithelium and floating in the mucus (star). (B) H&E staining (objective magnification, $\times 50$) of the same section reveals tightly coiled rods in the mucus (stars) and along the epithelium (arrows).



A



B

Figure 41-73 Secondary syphilis. (A) A skin section stained with H&E (objective magnification, $\times 40$) shows a blood vessel (star) surrounded by lymphocytes (red arrows) and plasma cells (black arrows) in the dermis. (B) A Warthin-Starry stain (objective magnification, $\times 50$) of the same tissue shows tightly coiled spirochetes (arrows) typical of *Treponema pallidum*.

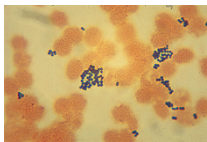
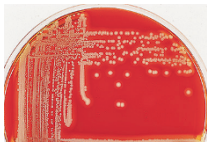
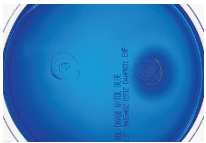

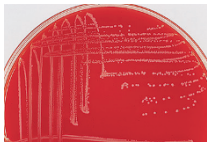

Fast Facts: Bacteria

42

This chapter is intended to provide a concise source that one can view at a glance to find the essential information regarding the more common bacterial isolates encountered in the clinical laboratory. The tables cover the distinguishing features of each organism such as Gram stain morphology, growth, and phenotypical characteristics as well as clinical presentation. The thumbnail photos can be seen as full-size illustrations in the respective main chapters in this volume.

This chapter is not intended as a substitute for textbooks or manuals. The decision about what constitutes key information is quite subjective, and we apologize for any omissions. Within each table our intent was to include most of the important facts to know for both practical quick reference in the laboratory and exam preparation.

Chapter 1 *Staphylococcus* and *Micrococcus*^a

Organism	Gram stain morphology	Growth characteristics	Key phenotypic characteristics for identification	Additional information	Clinical presentation
<i>Staphylococcus aureus</i>	GPC in pairs and clusters (Fig. 1-1) 	Cream to golden pigmented, beta-hemolytic colonies (Fig. 1-3) 	Catalase: + Tube coagulase: + Clumping factor: + DNase: + (Fig. 1-16) 	MRSA: <i>mecA</i> (PBP2a) <i>mecC</i> (PBP2c)	Skin infections, bloodstream infections, osteomyelitis, pneumonia, and endocarditis Toxin-producing bullous impetigo, scalded-skin syndrome, and toxic shock syndrome Food poisoning (enterotoxin)
<i>S. epidermidis</i>	GPC in pairs and clusters	White, nonhemolytic colonies (Fig. 1-6) 	Catalase: + Tube coagulase: 0	Can be methicillin resistant, <i>mecA</i>	Endocarditis, right-side endocarditis in intravenous-drug users
<i>S. saprophyticus</i>	GPC in pairs and clusters	Nonpigmented or pigmented colonies	Catalase: + Tube coagulase: 0 Novobiocin: R	Biofilm production	Noncomplicated urinary tract infections in sexually active young females
<i>S. lugdunensis</i>	GPC in pairs and clusters	Cream colonies; might have beta-hemolytic colonies (Fig. 1-7) 	Catalase: + Clumping factor: + Tube coagulase: 0 Ornithine: + (Fig. 1-18) 	<i>mecA</i> uncommon Biofilm production Can be misidentified as <i>S. aureus</i> due to positive clumping factor	Endocarditis, septicemia, and joint infections

S. schleiferi

GPC in pairs and clusters

Nonpigmented colonies

Catalase: +
Clumping factor: +
Tube coagulase: 0
DNase: +

Can be misidentified as *S. aureus* due to positive clumping factor

Soft-tissue infections, endocarditis, septicemia, and joint infections

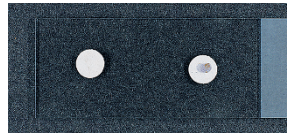
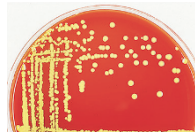
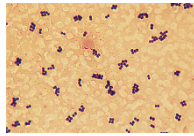
Micrococcus luteus

GPC in pairs, clusters, and tetrads (Fig. 1-2)

Yellow-pigmented colonies (Fig. 1-8)

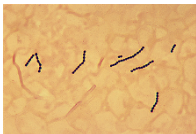

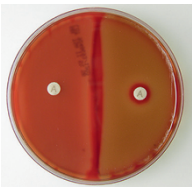
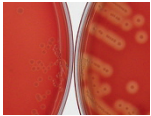
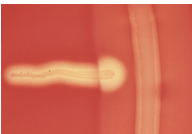
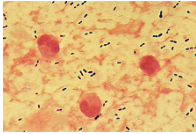
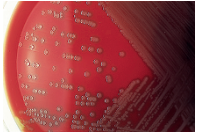
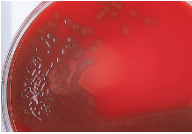
Microdase: + (Fig. 1-22)

Meningitis, central nervous system shunt infections, endocarditis, and septic arthritis

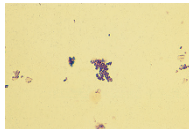


^aGPC, Gram-positive cocci; microdase, modified oxidase test; MRSA, methicillin-resistant *S. aureus*; ornithine, ornithine decarboxylase; PBP, penicillin-binding protein; R, resistant; +, positive; 0, negative.

Chapter 2 *Streptococcus*^a


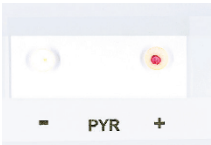

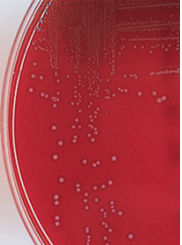

Organism	Gram stain morphology	Growth characteristics	Key phenotypic characteristics for identification	Additional information	Clinical presentation
<i>Streptococcus pyogenes</i>	GPC in pairs and chains (Fig. 2-1) 	Large zone of beta-hemolysis (Fig. 2-6) 	Lancefield group A antigen PYR: + VP: 0 Bacitracin: S (Fig. 2-16) 	Additional tests: • Direct detection of group A antigen followed by culture if negative • NAAT: sensitivity of 90% • M protein for epidemiology • ASO and anti-DNase B titers for diagnosis of sequelae	Pharyngitis, impetigo, bacteremia, and soft tissue infections. Sequelae: rheumatic fever, glomerulonephritis, scarlatiniform rash of scarlet fever, toxic shock-like syndrome, and necrotizing fasciitis
<i>S. agalactiae</i>	GPC in pairs and chains	Narrow zone of beta-hemolysis (Fig. 2-8) 	Lancefield group B antigen Hippurate: + CAMP: + (Fig. 2-18) 	Enrichment broth (LIM) for optimal recovery Differential media: Carrot broth and Granada agar NAAT after overnight incubation	Newborn infection due to either transmission at birth or postnatal acquisition
<i>S. dysgalactiae</i> subsp. <i>equisimilis</i>	GPC in pairs and chains	Large colonies	Lancefield group C or G antigen; groups L and A have been described		Resembles infections caused by <i>S. pyogenes</i>
<i>S. pneumoniae</i>	GPC in pairs (lancet-shaped) (Fig. 2-3) 	Alpha-hemolysis with "punched-out" center (Fig. 2-9) 	Quellung reaction: + Bile solubility: + (Fig. 2-22)  Optochin: S	Additional tests: • Urine and CSF antigen tests • NAAT Vaccine available to protect against invasive infection	Community-acquired pneumonia, bacteremia, endocarditis, meningitis, sinusitis, and otitis media

<i>S. anginosus</i> group	GPC in pairs and chains	Small colonies; can be alpha-hemolytic, beta-hemolytic, or nonhemolytic	Bacitracin: R PYR: 0 VP: + Arginine: +	Colony has butterscotch odor	Endocarditis and abscesses
<i>S. gallolyticus</i>	GPC in pairs and chains	Alpha-hemolytic or nonhemolytic	Lancefield group D antigen 40% bile: + Hydrolyze esculin: + 6.5% NaCl: + PYR: 0		Bacteremia (associated with colorectal cancer), endocarditis, and meningitis
<i>S. mitis</i> group	GPC in pairs and chains	Alpha-hemolytic	VP: 0 Urease: 0 Arginine: 0		Endocarditis and associated with dental plaque
<i>S. mutans</i> group	GPC or short bacilli (Fig. 2-4)	Alpha-hemolytic	Arginine: 0 Esculin: + VP: + Urease: 0 Hyaluronidase: 0		Associated with dental caries



^aASO, antistreptolysin O; CSF, cerebrospinal fluid; GPC, Gram-positive cocci; NAAT, nucleic acid amplification test; PYR, pyrrolidonyl arylamidase; R, resistant; VP, Voges-Proskauer; +, positive; 0, negative.

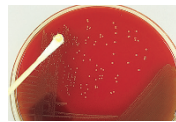
Chapter 3 *Enterococcus*^a

Organism	Gram stain morphology	Growth characteristics	Key phenotypic characteristics for identification	Additional information	Clinical presentation
<i>Enterococcus faecalis</i>	GPC in pairs and short chains	Alpha-hemolytic or nonhemolytic (Fig. 3-2, left) 	Lancefield group D antigen ^b Catalase: 0 Motility: 0 6.5% NaCl: + Esculin: + Arabinose: 0 MGP: 0 PYR: + (Fig. 3-6C)  LAP: 0 (Fig. 3-6D) 	VRE: resistance genes: • <i>vanA</i> : transferable high-level vancomycin and glycopeptide resistance • <i>vanB</i> : transferable variable-level (moderate to high) resistance to vancomycin	Health care-related bloodstream infections and urinary tract infections, and endocarditis
<i>E. faecium</i>	GPC in pairs and short chains	Alpha-hemolytic or nonhemolytic (Fig. 3-2, right) 	Lancefield group D antigen ^b Catalase: 0 Motility: 0 6.5% NaCl: + Esculin: + MGP: 0 PYR: + LAP: + Arabinose: + (Fig. 3-7) 	Majority of VRE are <i>E. faecium</i> <i>vanA</i> : transferable high-level vancomycin and glycopeptide resistance <i>vanB</i> : transferable variable-level (moderate to high) resistance for vancomycin	Health care-related bloodstream infections and urinary tract infections, wound infections, and endocarditis

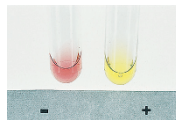
E. casseliflavus,
E. gallinarum

GPC in pairs
and short
chains

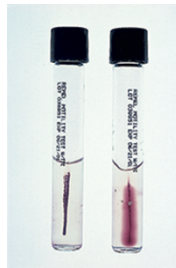
E. casseliflavus: slight
yellow pigment
(Fig. 3-3)



Lancefield group D
antigen^b
Arabinose: +
MGP: + (Fig. 3-8)



Motility: + (Fig. 3-9)



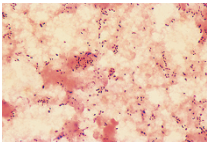
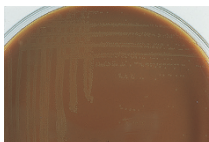
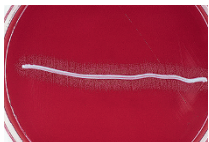

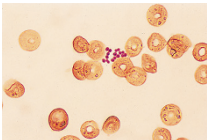
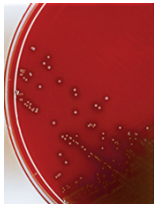
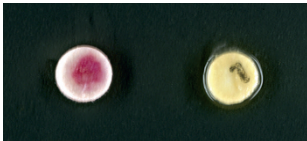
VRE: Resistance genes:
vanC: chromosomal, intrinsic
low-level vancomycin
resistance (MICs, 2–32 µg/ml)
Not associated with the wide
spread of vancomycin
resistance

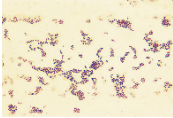
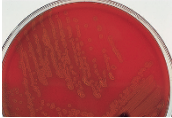

Health care-related bloodstream
infections and urinary tract
infections, wound infections, and
endocarditis

^aArabinose, arabinose utilization; esculin, hydrolysis of esculin in the presence of bile salts; GPC, Gram-positive cocci; LAP, leucine aminopeptidase production; MGP, acidification of methyl- α -D-glucopyranoside; PYR, pyrrolidonyl arylamidase production; VRE, vancomycin-resistant enterococci; +, positive; 0, negative; 6.5% NaCl, growth in broth containing 6.5% NaCl.

^bGroup D Lancefield antigen is detected in only about 80% of enterococcal strains.

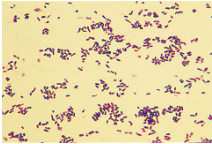


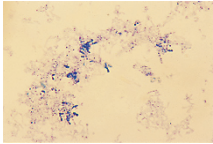
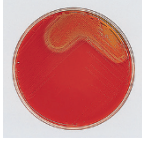



Chapter 4 *Aerococcus*, *Abiotrophia*, and Other Miscellaneous Gram-Positive Cocci That Grow Aerobically^a

Organism	Gram stain morphology	Growth characteristics	Key phenotypic characteristics for identification	Additional information	Clinical presentation
<i>Abiotrophia</i> and <i>Granulicatella</i>	GPC in pairs or chains or coccobacilli (Fig. 4-4) 	SBA: no growth Alpha-hemolytic or nonhemolytic (Fig. 4-12) 	LAP: + PYR: +	Vancomycin: S Nutritionally deficient Requires source of pyridoxal Satellite growth (Fig. 4-13) 	Bacteremia, endocarditis (usually in immunocompromised individuals)
<i>Aerococcus urinae</i>	GPC in pairs, tetrads, or clusters	Alpha-hemolytic (Fig. 4-5) 	LAP: + PYR: 0	Vancomycin: S	Urinary tract infections (elderly)
<i>Aerococcus viridans</i>	GPC in pairs, tetrads, or clusters (Fig. 4-1) 	Alpha-hemolytic (Fig. 4-5) 	6.5% NaCl: + LAP: 0 PYR: + (Fig. 4-6) 	Vancomycin: S Rare strains may be weakly catalase +	Bacteremia, endocarditis

<i>Leuconostoc</i>	GPC in pairs or chains (Fig. 4-3)	Alpha-hemolytic (Fig. 4-8)	LAP: 0 PYR: 0 Gas production: + Arginine: 0	Vancomycin: R (Fig. 4-9)	Bacteremia, endocarditis
					
<i>Pediococcus</i>	GPC in tetrads or clusters	Alpha-hemolytic, resembling viridans group streptococci	LAP: + PYR: 0 6.5% NaCl: V Bile esculin: V Gas production: 0	Vancomycin: R	Bacteremia, endocarditis
<i>Weissella</i>	GPC in pairs or chains	Alpha-hemolytic; may be misidentified as <i>Lactobacillus</i> -like or viridans group streptococci	LAP: 0 PYR: 0 Gas production: + Arginine: + 6.5% NaCl: +	Vancomycin: R	Bacteremia, endocarditis

*GPC, Gram-positive cocci; LAP, leucine aminopeptidase production; PYR, pyrrolidonyl arylamidase production; R, resistant; S, susceptible; SBA, sheep blood agar; 6.5% NaCl, growth in broth containing 6.5% NaCl; +, positive; 0, negative; V, variable.

Chapter 5 Coryneform Gram-Positive Bacilli*

Organism	Gram stain morphology	Growth characteristics	Key phenotypic characteristics for identification	Additional information	Clinical presentation
<i>Corynebacterium diphtheriae</i>	GPB, club-shaped, palisades, V and L forms (Fig. 5-2) 	Nonhemolytic (Fig. 5-3, left) 	Catalase: + Tellurite: gray-black colonies (Fig. 5-5) 	Loeffler's: enhances growth with metachromatic granules (methylene blue) (Fig. 5-7)  Phage transmit toxin genes Toxigenicity test: PCR (<i>tox gene</i>) ^b and Elek test Vaccine available	Respiratory and skin infections, endocarditis and pharyngitis with pseudomembrane
<i>C. jeikeium</i>	GPB, club-shaped, palisades, V and L forms	Growth enhanced by Tween 80 (lipophilic) (Fig. 5-9) 	Catalase: +	MDRO (usually)	Bacteremia, endocarditis, prosthetic devices, heart valve, bone marrow, bile, wounds, urinary tract infections
<i>C. striatum</i>	GPB, club-shaped, palisades, V and L forms	1.0–1.5 mm, dry, creamy, moist with entire edges	Catalase: +	CAMP: weakly + MDRO (usually)	Sterile body fluids, tissue, prosthetic devices
<i>C. urealyticum</i>	GPB, club-shaped, palisades, V and L forms	Growth enhanced by Tween 80 (lipophilic); pinpoint to small (ca. 0.5 to 1 mm), convex (Fig. 5-13) 	Catalase: + Urea: + (strong) (Fig. 5-14) 	Reverse CAMP: + (Fig. 5-21) 	Urinary tract infections (struvite crystal)

*Arcanobacterium
haemolyticum*

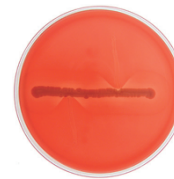
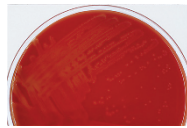
GPB

Small, beta-hemolytic
(Fig. 5-16)

Catalase: 0
Motility: 0

Reverse CAMP: + (Fig. 5-21)

Pharyngitis (teens/young
adults), bacteremia,
endocarditis, wound
and tissue infections



*Gardnerella
vaginalis*

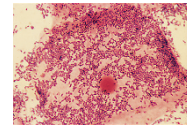
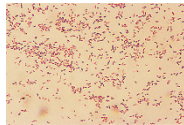
GVB or coccobacilli
(Fig. 5-18)

Barely visible at 48 h

Catalase: 0
Oxidase: 0
Hippurate: +

V agar (human blood)

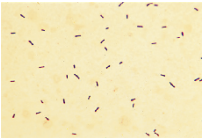
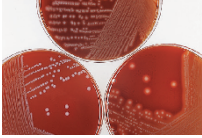
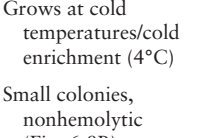

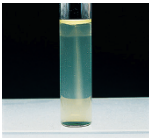
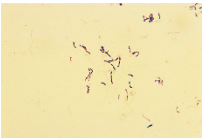


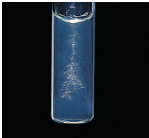
Bacterial vaginosis (clue
cells) (Fig. 5-19)



^aGPB, Gram-positive bacilli; GVB, Gram-variable bacilli; Loeffler's, Loeffler's serum medium; MDRO, multidrug-resistant organism; reverse CAMP, CAMP inhibition test; tellurite, tellurite medium (Tinsdale or cystine-tellurite blood agar); V agar, vaginalis agar; +, positive; 0, negative.

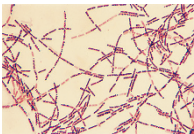
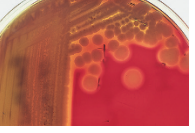
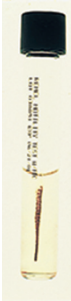

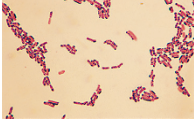
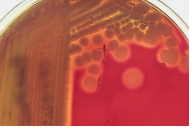

^bIn addition to *C. diphtheriae*, *C. ulcerans* and *C. pseudotuberculosis* can harbor the diphtheria toxin gene.

Chapter 6 *Listeria* and *Erysipelothrix*^a

Organism	Gram stain morphology	Growth characteristics	Key phenotypic characteristics for identification	Additional information	Clinical presentation
<i>Listeria monocytogenes</i>	GPB, single or short chains Non-spore forming (Fig. 6-1A) 	Small, narrow zone of beta-hemolysis (Fig. 6-2A)  Grows at cold temperatures/cold enrichment (4°C) 	Catalase: + Esculin: + VP: + Methyl red: + Hippurate: + CAMP: + (shovel) (Fig. 6-5) 	Tumbling motility (wet mount) Umbrella-shaped motility in semisolid agar (Fig. 6-4) 	Foodborne illness: dairy products and meat Septicemia, meningitis, and encephalitis Pregnant women (amnionitis), newborns (early- and late-onset forms and granulomatosis infantiseptica), patients with impaired cell-mediated immunity, and elderly
<i>Erysipelothrix rhusiopathiae</i>	GPB, singly or short chains Non-spore forming (Fig. 6-7B) 	Small colonies, nonhemolytic (Fig. 6-8B) 	Catalase: 0 Esculin: 0 VP: 0 Methyl red: 0 H ₂ S: + (Fig. 6-10) 	Motility: 0 Gelatin stab: “pipe cleaner” pattern of growth (Fig. 6-9)  Vancomycin: R	Contracted through direct contact via skin abrasions, injuries, or animal bites (swine and fish) Erysipeloid: cutaneous infection on hands Occupational exposure: veterinarians, butchers, and fish handlers

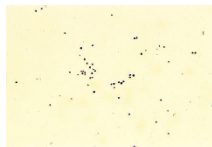
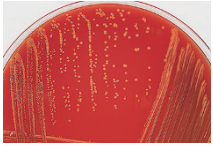
^aEsculin, hydrolysis of esculin; GPB, Gram-positive bacilli; hippurate, hippurate hydrolysis test; H₂S, hydrogen sulfide production; R, resistant; VP, Voges-Proskauer reaction; +, positive; 0, negative.

Chapter 7 *Bacillus*^a

Organism	Gram stain morphology	Growth characteristics	Key phenotypic characteristics for identification	Additional information	Clinical presentation
<i>Bacillus anthracis</i>	GPB but can be GV Long chains; bamboo joints Central or subterminal spores Capsule: + (Fig. 7-1) 	Nonhemolytic Irregular borders (medusa head) 	Catalase: + Motility: 0 (Fig. 7-11, left) 	Tenacious test: + (Fig. 7-9) 	Cutaneous (most common): black eschar Inhalation: widened mediastinum Gastrointestinal (ingestion)
<i>B. cereus</i>	GPB but can be GV Central or subterminal spores (Fig. 7-4) 	Large, beta-hemolytic (Fig. 7-10) 	Catalase: + Motility: + (Fig. 7-11, right) 		Foodborne illness: fried rice (heat-stable or heat-labile enterotoxin) Catheter-related bacteremia Eye and wound infections (traumatic)
<i>B. cereus</i> biovar anthracis	GPB Capsule: +	Nonhemolytic	Motility: V (majority +)		Anthrax-like disease

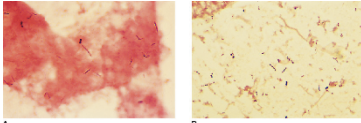
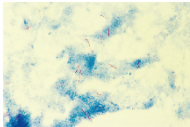
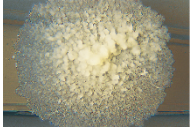
^aGPB, Gram-positive bacilli; GV, Gram variable; +, positive; 0, negative; V, variable.

Chapter 8 *Nocardia*, *Rhodococcus*, *Actinomadura*, *Streptomyces*, *Gordonia*, and Other Aerobic Actinomycetes^a

Organism	Gram stain morphology	Growth characteristics	Key phenotypic characteristics for identification	Additional information	Clinical presentation
<i>Nocardia brasiliensis</i>	Beaded GPB with filamentous branches	Chalky aerial hyphae Mature in 7–9 days		MAF: + Preferred methods for identification: • NAAT • Proteomics	Actinomycotic mycetomas
<i>N. cyriaci</i> / <i>N. georgica</i>	Beaded GPB with filamentous branches	Morphology varies by media SBA: white to pale yellow, chalky, flat to mildly ruffled Mature in 7–9 days		MAF: + Preferred methods for identification: • NAAT • Proteomics	Pulmonary disease, brain abscess
<i>Rhodococcus equi</i>	GP coccobacilli (Fig. 8-11) 	Can be salmon-pink pigmented (on day 3–5) (Fig. 8-12) 	Gram stain Colony morphology	MAF: +	Granulomatous pneumonia in immunocompromised patients
<i>Actinomadura</i> spp.	Thin GPB with short branching filaments	Powdery aerial hyphae Mature in 4–10 days		MAF: + Preferred methods for identification: • NAAT • Proteomics	Actinomycotic mycetomas (Madura foot)

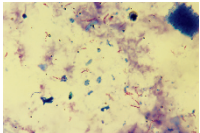
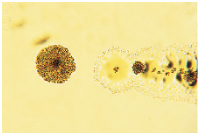
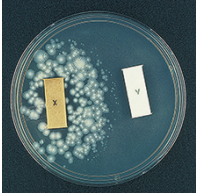
^aGPB, Gram-positive bacilli; MAF, modified acid-fast stain; NAAT, nucleic acid amplification test; SBA, sheep blood agar; +, positive.


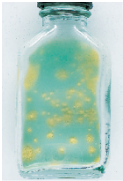


Chapter 9 *Mycobacterium*^a

Organism	Gram stain morphology	Growth characteristics	Key phenotypic characteristics for identification	Additional information	Clinical presentation
<p><i>Mycobacterium tuberculosis</i> complex</p> <p><i>Mycobacterium tuberculosis</i></p>	<p>Not reliably detected by Gram stain (ghost-like)</p> <p>Beaded, Gram-positive bacilli (Fig. 9-3)</p>  <p>Ziehl-Neelsen or Kinyoun stains: red-purple, curved, short or long bacilli (Fig. 9-1A)</p> 	<p>Buff and rough colonies (Fig. 9-6C)</p> 	<p>Nitrates: +</p> <p>T₂H: +</p> <p>PZA: S</p> <p>Niacin: +</p> <p>Pyrazinamidase: +</p>	<p>Preferred methods for identification:</p> <ul style="list-style-type: none"> • NAAT: directly from the clinical specimen • Proteomics <p>Additional tests:</p> <ul style="list-style-type: none"> • Tuberculin skin test (PPD) • Interferon gamma release assays 	<p>Pulmonary, extrapulmonary, miliary, or latent</p> <p>Transmission is via airborne particles</p>
<p><i>M. bovis</i></p>	<p>Auramine-rhodamine stain</p> <p>Not reliably detected by Gram stain</p> <p>Best detected by acid-fast stains or auramine-rhodamine stain</p>	<p>Small and flat on agar media</p>	<p>Nitrates: 0</p> <p>T₂H: 0</p> <p>PZA: R</p> <p>Pyrazinamidase: 0</p>	<p>Preferred methods for identification:</p> <ul style="list-style-type: none"> • Molecular assays • Proteomics <p>Attenuated BCG strain is used for TB vaccination (protects against meningitis and disseminated tuberculosis) and to treat certain tumors</p>	<p>Tuberculosis-like disease</p> <p>Transmission is via inhalation and consumption of unpasteurized milk and cheese products</p>

(continued)

Chapter 9 *Mycobacterium*^a (Continued)

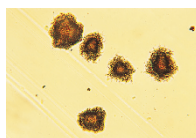
Organism	Gram stain morphology	Growth characteristics	Key phenotypic characteristics for identification	Additional information	Clinical presentation
Nontuberculous mycobacteria: slow growers					
<i>M. avium</i> and <i>M. intracellulare</i> (members of the <i>M. avium</i> complex)	Not reliably detected by Gram stain Best detected by acid-fast stains or auramine-rhodamine stain Beaded (Fig. 9-4A)	Nonchromogen Buff colored Reverse: "sunspot" (Fig. 9-7D)	Niacin: 0 Nitrate: 0 Tween: 0 Pyrazinamidase: +	Preferred methods for identification: • Molecular assays • Proteomics	Respiratory disease: middle-aged male smokers and postmenopausal females with bronchiectasis (Lady Windermere syndrome) Unilateral adenitis Disseminated disease HIV ⁺ patients
					
<i>M. chimaera</i> (member of the <i>M. avium</i> complex)	Not reliably detected by Gram stain Best detected by acid-fast stains or auramine-rhodamine stain	Nonchromogen		Preferred methods for identification: • Molecular assays • Proteomics	Prosthetic valve endocarditis, vascular graft infection, or disseminated disease 1 to 4 years following cardiac bypass surgery (contaminated heater-cooler units)
<i>M. ulcerans</i>	Not reliably detected by Gram stain Best detected by acid-fast stains or auramine-rhodamine stain	Nonchromogen Optimal growth: 30°C Extended period (3 months)	Nitrate: 0	Preferred methods for identification: • Molecular assays • Proteomics	Cutaneous disease: Buruli ulcer (Africa) and Bairnsdale ulcer (Australia)
<i>M. haemophilum</i>	Not reliably detected by Gram stain Best detected by acid-fast stains or auramine-rhodamine stain	Optimal growth: 30°C Nonchromogen (Fig. 9-12)		Requires hemin or hemoglobin for growth Preferred methods for identification: • Molecular assays • Proteomics	Cutaneous disease, especially in HIV ⁺ patients Cervical lymphadenopathy in children
					
<i>M. genavense</i>	Not reliably detected by Gram stain Best detected by acid-fast stains or auramine-rhodamine stain	Nonchromogen		Requires an iron chelator (mycobactin J) for growth Extended incubation Preferred methods for identification: • Molecular assays • Proteomics	Disseminated diseases in immunocompromised patients

<i>M. kansasii</i>	Not reliably detected by Gram stain Best detected by acid-fast stains or auramine-rhodamine stain	Photochromogen (Fig. 9-13) 	Nitrate: + Pyrazinamidase: 0 Tween: +	Preferred methods for identification: • Molecular assays • Proteomics	Chronic pulmonary disease: isolated more frequently from individuals with AIDS or organ transplants
<i>M. marinum</i>	Not reliably detected by Gram stain Best detected by acid-fast stains or auramine-rhodamine stain	Photochromogen (Fig. 9-14) 	Pyrazinamidase: +	Preferred methods for identification: • Molecular assays • Proteomics	Cutaneous disease (fish tank granuloma)
<i>M. simiae</i>	Not reliably detected by Gram stain Best detected by acid-fast stains or auramine-rhodamine stain	Optimal growth: 30°C Photochromogen (Fig. 9-17) 	Niacin: +	Preferred methods for identification: • Molecular assays • Proteomics	Clinical presentation similar to that caused by <i>M. avium-M. intracellulare</i> complex in patients with AIDS
<i>M. szulgai</i>	Not reliably detected by Gram stain Best detected by acid-fast stains or auramine-rhodamine stain	Scotochromogenic at 37°C Photochromogenic at 25°C (Fig. 9-18) 	Nitrate: + Tween: V Urease: +	Preferred methods for identification: • Molecular assays • Proteomics	Chronic pulmonary disease similar to tuberculosis in middle-aged men

(continued)

Chapter 9 *Mycobacterium*^d (Continued)

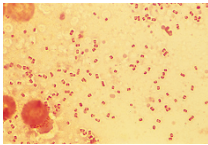



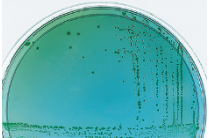

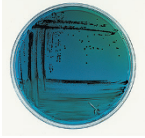
Organism	Gram stain morphology	Growth characteristics	Key phenotypic characteristics for identification	Additional information	Clinical presentation
<i>M. xenopi</i>	Not reliably detected by Gram stain Best detected by acid-fast stains or auramine-rhodamine stain	Scotochromogen (some strains are nonpigmented) Optimal growth: 45°C Bird's-nest appearance (Fig. 9-19)	Nitrate: 0 Tween: 0 Urease: 0	Preferred methods for identification: • Molecular assays • Proteomics	Chronic respiratory disease, cutaneous infections, septic arthritis, and disseminated disease May contaminate hot water systems
<i>M. goodii</i>	Not reliably detected by Gram stain Best detected by acid-fast stains or auramine-rhodamine stain	Scotochromogen (Fig. 9-11)	Nitrate: 0 Tween: + Urease: 0	Preferred methods for identification: • Molecular assays • Proteomics	Rarely causes disease in humans Usually isolated as a contaminant from tap water
<i>M. scrofulaceum</i>	Not reliably detected by Gram stain Best detected by acid-fast stains or auramine-rhodamine stain	Scotochromogen (Fig. 9-16)	Nitrate: 0 Urease: + Tween: 0	Preferred methods for identification: • Molecular assays • Proteomics	Cervical lymphadenitis in children younger than 5 years
Nontuberculous mycobacteria: rapid growers <i>M. fortuitum</i> group	Not reliably detected by Gram stain Best detected by acid-fast stains	Buff-colored colonies (Fig. 9-10)	Arylsulfatase: + NaCl tolerance: + Nitrate: + Iron uptake: +	Preferred methods for identification: • Molecular assays • Proteomics	Cutaneous infections: secondary to a penetrating injury, such as trauma or surgical procedure, associated with contaminated water or soil



<i>M. chelonae</i>	Not reliably detected by Gram stain Best detected by acid-fast stains	Buff-colored colonies (Fig. 9-9C)	Arylsulfatase: + NaCl tolerance: 0 Nitrate: 0 Iron uptake: 0	Preferred methods for identification: • Molecular assays • Proteomics	Cutaneous infections: frequently associated with a disseminated nodular skin disease in immunocompromised individuals
<i>M. abscessus</i>	Not reliably detected by Gram stain Best detected by acid-fast stains	Dark buff-colored colonies (Fig. 9-8)	Arylsulfatase: + NaCl tolerance: + Nitrate: 0 Iron uptake: 0	Preferred methods for identification: • Molecular assays • Proteomics	Cutaneous infections: associated with several injection- and catheter-related outbreaks of health care-related infections Pulmonary and disseminated cutaneous lesions in immunosuppressed patients
<i>M. mucogenicum</i>	Not reliably detected by Gram stain Best detected by acid-fast stains	Buff-colored colonies (Fig. 9-15)		Preferred methods for identification: • Molecular assays • Proteomics	Infrequently causes human diseases
Noncultivable nontuberculous mycobacteria <i>M. leprae</i>	Not reliably detected by Gram stain Best detected by modified acid-fast stain (Fite-Faraco) (Fig. 9-5)	Nonculturable <i>in vitro</i> ; grows in the nine-banded armadillo		Lepromin (skin test) NAAT directly from the clinical specimen: more sensitive	Hansen's disease: chronic granulomatous disease that usually manifests with anesthetic skin lesions and peripheral neuropathy

^aNAAT, nucleic acid amplification test; nitrate, nitrate reductase activity; PZA, pyrazinamide; R, resistant; S, susceptible; T₂H, ability to grow on thiophene-2-carboxylic acid hydrazide; Tween, Tween 80 hydrolysis test; +, positive; 0, negative.

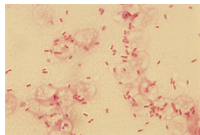




Chapter 11 *Escherichia, Shigella, and Salmonella*^a

Organism	Gram stain morphology	Growth characteristics	Key phenotypic characteristics for identification	Additional information	Clinical presentation
<i>Escherichia coli</i>	GNB, short, plump, straight rod with bipolar staining (safety pin) (Fig. 11-1) 	SBA: gray, smooth, and often beta-hemolytic MAC: pink colonies (Fig. 11-2)  HE and XLD: salmon to yellow (Fig. 11-3) 	Lactose: + Motility: + IMViC: ++00 (Fig. 11-6)  MUG: + TSI: A/AG (5% can be inactive)	STEC O157: colorless colonies on SMAC STEC O157:H7: major virulence factors are Shiga toxins (Stx1 and Stx2)	Extraintestinal: UTI, CAUTI, neonatal meningitis Gastroenteritis: EAEC, ETEC, EPEC, EIEC, and EHEC/STEC (associated with HUS)
<i>Shigella</i> Subgroups A: <i>S. dysenteriae</i> B: <i>S. flexneri</i> C: <i>S. boydii</i> D: <i>S. sonnei</i> (most common)	GNB	MAC: colorless colonies HE and XLD: colorless colonies (Fig. 11-9) 	Lactose: 0 ^b Motility: 0 IMViC: V+00 H ₂ S: 0 TSI: Alk/A (Fig. 11-10) 	Infective dose via ingestion is low	Watery or bloody diarrhea <i>S. dysenteriae</i> : HUS <i>S. flexneri</i> : reactive arthritis or Reiter's chronic syndrome
<i>Salmonella</i> <i>S. enterica</i> (subdivided into 6 subspecies) <i>S. bongori</i>	GNB	HE: black colonies (H ₂ S) (Fig. 11-11) 	<i>Salmonella</i> spp. Lactose: 0 Motility: + IMViC: 0+0+ Nontyphoidal TSI: Alk/AG H ₂ S: + <i>S. Paratyphi</i> A H ₂ S (TSI): 0 or weakly + <i>S. Typhi</i> : IMViC: 0+00 H ₂ S (TSI): weakly + (mustache-like)	<i>S. Typhi</i> and <i>Paratyphi</i> express the Vi capsular antigen Typhoid vaccine available	Enteric fever: <i>S. Typhi</i> and <i>Paratyphi</i> Pediatric osteomyelitis: sickle cell diseases Carrier state: gallbladder

^aA, acid; Alk, alkaline; CAUTI, catheter-associated urinary tract infections; EAEC, enteroaggregative *E. coli*; EHEC, enterohemorrhagic *E. coli*; EIEC, enteroinvasive *E. coli*; EPEC, enteropathogenic *E. coli*; EIEC, enteroinvasive *E. coli*; G, gas; GNB, Gram-negative bacilli; HE, Hektoen enteric agar; H₂S, hydrogen sulfide; HUS, hemolytic-uremic syndrome; IMViC, indole, methyl red, Voges-Proskauer, citrate utilization; MAC, MacConkey agar; MUG, methylumbelliferyl-β-D-glucuronide positive; SMAC, sorbitol-containing MacConkey agar medium; STEC, Shiga toxin-producing *E. coli*; TSI, triple sugar iron; UTI, urinary tract infections; VP, Voges-Proskauer; XLD, xylose lysine deoxycholate agar; +, positive; 0, negative.

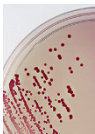
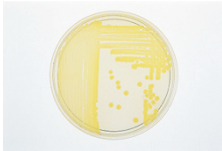
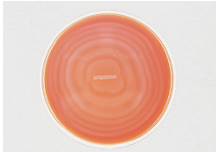
^bThe exception is *S. sonnei*, which is a late lactose fermenter.

Chapter 12 *Klebsiella*, *Enterobacter*, *Citrobacter*, *Cronobacter*, *Serratia*, *Plesiomonas*, and Selected Other *Enterobacterales*^a

Organism	Gram stain morphology	Growth characteristics	Key phenotypic characteristics for identification	Additional information	Clinical presentation
<i>Klebsiella granulomatis</i>	GNB	Cannot be cultured on conventional media		Detection of Donovan bodies from tissue smears using the Giemsa or Wright stain	Chronic genital ulcers (donovanosis or granuloma inguinale)
<i>K. oxytoca</i>	GNB	MAC: lactose fermenter	Motility: 0 IMViC: +V++		Antibiotic-associated hemorrhagic colitis
<i>K. pneumoniae</i> subsp. <i>pneumoniae</i>	GNB (Fig. 12-1) 	MAC: lactose fermenter, encapsulated strains are mucoid (Fig. 10-6) 	Motility: 0 IMViC: 0V++	Hypermucoviscous strain of <i>K. pneumoniae</i> Liver abscess due to these strains (K1 or K2 capsule) Endemic in Taiwan and Southeast Asia String test positive Important mechanism of resistance: carbapenemase (KPC)	Pneumonia (red currant jelly sputum), urinary tract infections, including health care-associated infections
<i>K. pneumoniae</i> subsp. <i>rhinoscleromatis</i>	GNB	MAC: lactose fermenter	Indole: 0 VP: 0 ONPG: 0		Rhinoscleroma
<i>Enterobacter cloacae</i> complex	GNB	MAC: late lactose fermenter (Fig. 12-2, left) 	ADH: + IMViC: 00++ (Fig. 12-6) 	Important mechanism of resistance: AmpC beta-lactamases	Health care-related colonization and infection (medical devices and instrumentation)
<i>Citrobacter freundii</i>	GNB	MAC: lactose fermenter (Fig. 12-3) 	IMViC: VV0V H ₂ S: + (78%) ODC: 0	Important mechanism of resistance: AmpC beta-lactamases	Bacteremia, urinary tract infections, gastrointestinal infections

(continued)

Chapter 12 *Klebsiella*, *Enterobacter*, *Citrobacter*, *Cronobacter*, *Serratia*, *Plesiomonas*, and Selected Other *Enterobacterales*^a (Continued)

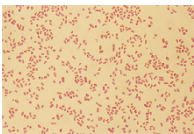
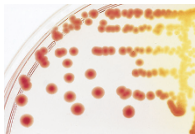


Organism	Gram stain morphology	Growth characteristics	Key phenotypic characteristics for identification	Additional information	Clinical presentation
<i>Citrobacter koseri</i>	GNB	MAC: lactose fermenter	VP: 0 Indole: + H ₂ S: 0 ODC: + Malonate: +	Important mechanism of resistance: AmpC beta-lactamases	Neonatal meningitis and brain abscesses
<i>Serratia marcescens</i>	GNB	Red pigment (prodigiosin) (Fig. 12-3) 	IMViC: 00++	Important mechanism of resistance: AmpC beta-lactamases	Health care-related infections
<i>Cronobacter sakazakii</i>	GNB	Yellow pigment (Fig. 12-8) 	ADH: + ODC: + Malonate: 0 IMViC: 00++		Neonatal meningitis and necrotizing enterocolitis (contaminated powdered milk formula)
<i>Proteus mirabilis</i>	GNB	Swarming growth (Fig. 10-3) 	Indole: 0 ODC: + H ₂ S: + Urease: +	Ampicillin: S	Urinary tract infections Urinary struvite stones and catheter encrustation
<i>P. vulgaris</i>	GNB	Swarming growth	Indole: + ODC: 0 H ₂ S: + Urease: +	Ampicillin: R	Wound infections Urinary struvite stones and catheter encrustation

<i>Morganella morganii</i>	GNB	Colonies appear off-white and opaque	Urease: + Phenylalanine deaminase: + IMViC: ++00	Important mechanism of resistance: AmpC beta-lactamases	Health care-associated infections, e.g., postoperative and urinary tract
<i>Plesiomonas shigelloides</i>	GNB, straight, short	Shiny, opaque, smooth, and nonhemolytic (Fig. 12-26)	Oxidase: + IMViC: ++00		Gastroenteritis



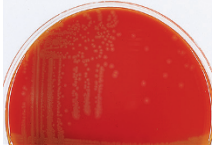
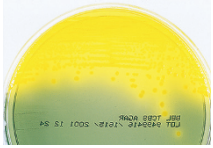
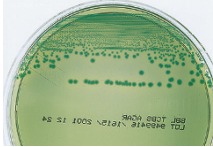
^aADH, arginine dihydrolase; GNB, Gram-negative bacilli; IMViC: indole, methyl red, Voges-Proskauer, citrate utilization; KPC, *K. pneumoniae* carbapenemase; MAC, MacConkey agar; ODC, ornithine decarboxylase; ONPG, *o*-nitrophenyl-D-galactopyranoside; V, variable; VP, Voges-Proskauer; +, positive; 0, negative.

Chapter 13 *Yersinia*^a

Organism	Gram stain morphology	Growth characteristics	Key phenotypic characteristics for identification	Additional information	Clinical presentation
<i>Yersinia enterocolitica</i>	GNB, small, plump (Fig. 13-1A) 	CIN: bull's eye (Fig. 13-7B)  Optimal growth: 25–28°C (can grow at 4°C) 	ODC: + Motility: + Urease: + IMViC: V+00 Sucrose: + (Fig. 13-5)	Acquired by ingestion of contaminated food or water	Enterocolitis to mesenteric lymphadenitis (appendicitis-like) Bacteremia (associated with red blood cell transfusions)
<i>Y. pestis</i>	GNB Best seen with Giemsa, Wright's, Wayson, or methylene blue stain (safety pin)	Pinpoint, nonhemolytic (Fig. 13-8)  Fried-egg appearance on prolonged incubation Optimal growth: 25–28°C (can grow at 4°C)	ODC: 0 Motility: 0 Urease: 0 IMViC: 0V00 Sucrose: 0	Vector: fleas Reservoir: rodent Select agent organism	Bubonic form (most common) Pneumonic form (can spread person to person) Septicemic form
<i>Y. pseudotuberculosis</i>	GNB, small, plump	Small gray and translucent colonies Optimal growth: 25–28°C MAC preferred for isolation; can be inhibited on CIN and CHROMagar	ODC: 0 Motility: + Urease: + Sucrose: 0	Acquired by ingestion of contaminated food or water	Mesenteric lymphadenitis

^aCIN, cefsulodin-irgasan-novobiocin; GNB, Gram-negative bacilli; IMViC, indole production, methyl red, Voges-Proskauer, citrate utilization; MAC, MacConkey agar; ODC, ornithine decarboxylase; +, positive; 0, negative; V, variable.

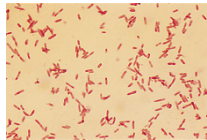
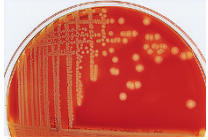
Chapter 14 *Vibrionaceae*^a

Organism	Gram stain morphology	Growth characteristics	Key phenotypic characteristics for identification	Additional information	Clinical presentation
<i>Vibrio cholerae</i>	GNB, curved, straight	Nonhemolytic, greenish coloration (Fig. 14-2) 	Oxidase: + Catalase: + 0% NaCl: + 6% NaCl: V Sucrose: + (yellow on TCBS) (Fig. 14-4) 	<i>V. cholerae</i> serogroup O1 and O139 (cholera toxin) <i>V. cholerae</i> non-O1: most common serogroup Vaccine available	<i>V. cholerae</i> serogroup: O1: asymptomatic to watery diarrhea (rice water stools) Non-O1: gastroenteritis, sepsis, and wound infections
<i>V. parahaemolyticus</i>	GNB, curved, straight	Greenish coloration 	Oxidase: + Urease: V ^b 0% NaCl: 0 6% NaCl: + Sucrose: 0 (green colonies on TCBS) (Fig. 14-6)	Most common species isolated from clinical specimens	Gastroenteritis following the consumption of raw, contaminated fish or shellfish
<i>V. vulnificus</i>	GNB, curved, straight	Nonhemolytic	Oxidase: + 0% NaCl: 0 6% NaCl: V Sucrose: 0 (15%: can be +)		Septicemia and wound infections after handling or consumption of raw oysters Predisposing conditions: liver disease, increased serum iron
<i>V. metschnikovii</i>	GNB, curved, straight	Nonhemolytic	Oxidase: 0 Catalase: 0 0% NaCl: 0 6% NaCl: V		

^aGNB, Gram-negative bacilli; % NaCl, growth in nutrient broth containing 0% or 6% NaCl; TCBS, thiosulfate citrate bile salts sucrose agar; V, variable; +, positive; 0, negative.

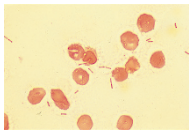

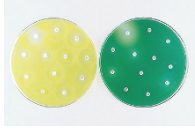

^bUrease-positive strains are thought to be more virulent than urease-negative strains.

Chapter 15 *Aeromonas*^a

Organism	Gram stain morphology	Growth characteristics	Key phenotypic characteristics for identification	Additional information	Clinical presentation
<i>Aeromonas</i>	Small, GNB and coccobacilli	Most species are beta-hemolytic CIN: improve recovery from contaminated specimens	Oxidase: + Indole: +	<i>A. dhakensis</i> : most frequently isolated and virulent species	Self-limiting gastroenteritis, septicemia, necrotizing fasciitis, infections following medicinal leech therapy
<i>A. hydrophila sensu stricto</i>	Small, straight, GNB or coccobacilli (Fig. 15-1) 	Beta-hemolytic (Fig. 15-2) 	Oxidase: + Indole: + VP: + ODC: 0 Esculin: +		
<i>A. caviae sensu stricto</i>	GNB	Nonhemolytic CIN: pink center	Oxidase: + Indole: + (occasional strains are negative) VP: 0 ODC: 0		
<i>A. veronii</i> biovar <i>sobria</i>	GNB	Appear round, raised with an entire edge and a smooth surface, translucent or white to buff colored	Oxidase: + Indole: + VP: + ODC: 0 Esculin: 0		Aggressive extraintestinal infections

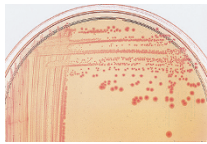
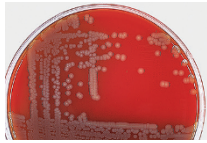
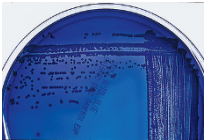
^aCIN, modified cefsulodin-irgasan-novobiocin agar; esculin, esculin hydrolase; GNB, Gram-negative bacilli; ODC, ornithine decarboxylase; VP, Voges-Proskauer; +, positive; 0, negative.

Chapter 16 *Pseudomonas*^a

Organism	Gram stain morphology	Growth characteristics	Key phenotypic characteristics for identification	Additional information	Clinical presentation
<i>Pseudomonas aeruginosa</i>	Slender GNB (Fig. 16-1) 	MAC: nonfermenter Isolates from CF patients: mucoid colonies and alginate material Beta-hemolytic with metallic sheen, grape-like odor (aminoacetophenone) (Fig. 16-2) 	Catalase: + Oxidase: + N ₂ : + Maltose: 0 Motility: + Growth at 42°C: +	Pigment production: Pyoverdin: yellow green Pyocyanin: blue green Pyorubin: red Pyomelanin: brown-black (Fig. 16-7) 	Health care-related infections, ecthyma gangrenosum, “swimmer’s ear,” hot tub folliculitis, keratitis, osteomyelitis, endocarditis in intravenous-drug users, and respiratory infections in CF patients
<i>P. stutzeri</i>	GNB	Dry and wrinkled colonies, can pit the agar (Fig. 16-8) 	Oxidase: + N ₂ : + Maltose: + ADH: 0 Growth at 42°C: V		Occasionally causes infection in immunocompromised patients such as bacteremia and meningitis

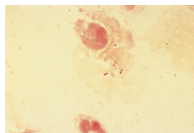
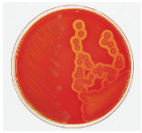


^aADH, arginine dihydrolase; CF, cystic fibrosis; GNB, Gram-negative bacilli; MAC, MacConkey agar; N₂, reduces nitrate to nitrogen gas; V, variable; +, positive; 0, negative.

Chapter 17 *Burkholderia*, *Stenotrophomonas*, *Ralstonia*, *Cupriavidus*, *Pandoraea*, *Brevundimonas*, *Comamonas*, *Delftia*, and *Acidovorax*^a

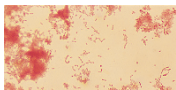

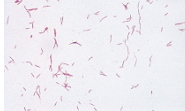

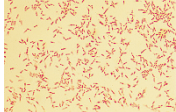
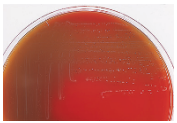

Organism	Gram stain morphology	Growth characteristics	Key phenotypic characteristics for identification	Additional information	Clinical presentation
<i>Burkholderia cepacia</i> complex	GNB, straight or slightly curved	Buff to yellow-tan pigment MAC: dark pink/red (lactose oxidation) (Fig. 17-2) 	Catalase: + Oxidase: + Nonfermenter Motility: +	Selective media improve recovery from contaminated specimens	At risk: chronic granulomatous disease and CF patients
<i>B. mallei</i>	GNB, straight or slightly curved	SBA: nonhemolytic, smooth, gray translucent colony in 2 days, no distinctive odor MAC: no growth or pinpoint colonies after 48 h	Catalase: + Oxidase: V Nonfermenter Motility: 0 Gentamicin: S Growth at 42°C: 0	Bioterrorism agent	Glanders disease in animals Rare in humans
<i>B. pseudomallei</i>	GNB, small with bipolar staining	SBA: nonhemolytic, small, smooth creamy colonies in the first 1–2 days, may change in time to dry, wrinkled colonies. Distinctive musty odor Grows on MAC Better recovery on Ashdown medium	Catalase: + Oxidase: + Nonfermenter Motility: + Gentamicin: R Growth at 42°C: +	Prevalent in Southeast Asia and northern Australia	Melioidosis (inhalation or contact)
<i>Stenotrophomonas maltophilia</i>	Straight GNB	Grows on MAC Nonhemolytic, greenish hue, ammonia odor (Fig. 17-5) 	Catalase: + Oxidase: V Nonfermenter Motility: + DNase: + (Fig. 17-6) 		Health care-acquired infections and infections in CF patients

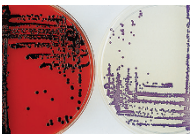
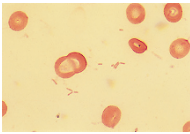



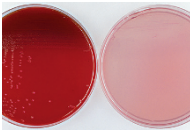
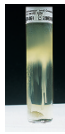
^aCF, cystic fibrosis; GNB, Gram-negative bacilli; MAC, MacConkey agar; R, resistant; S, susceptible; SBA, sheep blood agar; V, variable; +, positive; 0, negative.

Chapter 18 *Acinetobacter*, *Chryseobacterium*, *Moraxella*, *Methylobacterium*, and Other Nonfermentative Gram-Negative Bacilli*

Organism	Gram stain morphology	Growth characteristics	Key phenotypic characteristics for identification	Additional information	Clinical presentation
<i>Acinetobacter baumannii</i>	GNB or GV coccobacilli, single or pairs (Fig. 18-1) 	MAC: faint pink colonies Nonhemolytic, nonpigmented (Fig. 18-3) 	Oxidase: 0 Nitrate: 0 Motility: 0 (may have twitching motility)	Often associated with multidrug resistance	Ventilator-associated pneumonia and bloodstream infections Soldiers severely wounded in war and victims of natural disasters
<i>Moraxella catarrhalis</i>	GN coccobacilli, in pairs and short chains	MAC: 0 Hockey puck sign	Oxidase: + Motility: 0 Indole: 0 Asaccharolytic		Otitis, sinusitis, upper and lower respiratory infections in adults with COPD
<i>M. lacunata</i>	GN coccobacilli, in pairs and short chains	Small, greenish, may pit the agar after prolonged incubation (Fig. 18-6) 	Oxidase: + Motility: 0 Indole: 0 Gelatin: + Tween 80: +		Eye infections and infective endocarditis
<i>Chryseobacterium indologenes</i>	GNB that are thinner in the center than at the ends and can also appear as filamentous forms	Beta-hemolytic, deep yellow pigment (flexirubin) (Fig. 18-19) 	Catalase: + Motility: 0 Oxidase: + Indole: + Esculin: + Gelatin: + Growth at 42°C: 0		Ventilator-associated pneumonia, catheter-associated infection, neonatal meningitis and a multi-drug resistant strain isolated from a CF patient
<i>Elizabethkingia meningoseptica</i>	GNB	Large, nonpigmented or yellow to salmon pigment	Oxidase: + Mannitol: + Indole: + ONPG: + Gelatin: + Esculin: +		Neonatal meningitis, endocarditis and health care-related infections associated with dialysis
<i>E. anophelis</i>	GNB	SBA: smooth, yellowish, translucent and shiny MAC: no growth	Oxidase: + Mannitol: + Indole: + ONPG: + Gelatin: 0 Esculin: +	Predominant human pathogen of this genus	Known to cause sepsis in adults and children, neonatal meningitis; infections in immunocompromised patients

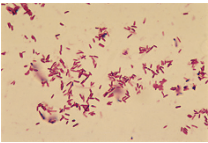
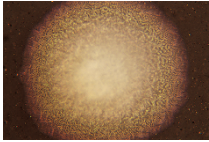
*CF, cystic fibrosis; COPD, chronic obstructive pulmonary disease; esculin, hydrolysis of esculin; GNB, Gram-negative bacilli; GV, Gram variable; MAC, MacConkey agar; ONPG, o-nitrophenyl-β-D-galactopyranoside; SBA, sheep blood agar; +, positive; 0, negative.

Organism	Gram stain morphology	Growth characteristics	Key phenotypic characteristics for identification	Additional information	Clinical presentation
<i>Actinobacillus</i> spp.	Small, oval GN coccobacilli	SBA and CHOC: pinpoint to small (48 h) colonies, grayish white, adherent, and nonhemolytic	Oxidase: + Nitrate: + Urea: +		
<i>Aggregatibacter actinomycetemcomitans</i>	GN, coccoid or rod-shaped bacilli and can exhibit filamentous forms (Fig. 19-1) 	Small colonies (24 h) (Fig. 19-2)  Star-like structure and pitting of the agar (>72 h)	Catalase: + Indole: 0 Nitrate: +	HACEK organism	Periodontitis, infective endocarditis following dental manipulations
<i>A. aphrophilus</i>	GNB	Granular to smooth and may be grayish to yellowish	Catalase: 0 Indole: 0 Nitrate: + Requires V factor (hemin)	HACEK organism	Systemic disease, bone and joint infections
<i>Capnocytophaga</i> spp.	Thin, fusiform, GNB (Fig. 19-7) 	Requires CO ₂ SBA and CHOC: tiny pinpoint (24 h), haze or swarming on the surface of the agar (gliding motility) MAC: no growth	Catalase: 0 Oxidase: 0	Normal oral microbiota of humans	Mainly in neutropenic patients: septicemia and other endogenous infections
<i>Capnocytophaga canimorsus</i>	Thin, fusiform, GNB	Requires CO ₂ SBA and CHOC: tiny pinpoint (24 h), haze or swarming on the surface of the agar (gliding motility) MAC: no growth (Fig. 19-8) 	Catalase: + Oxidase: +	Normal oral microbiota of dogs	Dog or cat bite or contact Septicemia with serious sequelae in alcoholics and splenectomized patients
<i>Cardiobacterium hominis</i>	Pleomorphic GNB with swollen ends, form rosette (Fig. 19-12) 	Requires CO ₂ SBA and CHOC: small, slightly alpha-hemolytic MAC: no growth (Fig. 19-13) 	Catalase: 0 Oxidase: + Nitrate: 0 Indole: weakly + (Fig. 19-14) 	HACEK organism	Endocarditis

<i>Chromobacterium violaceum</i>	GNB	Violet-pigmented colonies on blood agar (left) and Mueller-Hinton agar (right) (Fig. 19-15)	Catalase: + Nitrate: +		Contaminated wounds, septicemia, multiple abscesses
					
		MAC: growth			
<i>Eikenella corrodens</i>	Thin, GNB (Fig. 19-9)	Small pits; corrodes the surface of the agar; bleach-like odor (Fig. 19-10)	Catalase: 0 Oxidase: + Nitrate: +	HACEK organism	Endocarditis, fist injury and human bites
					
		MAC: no growth			
<i>Kingella kingae</i>	Small, GN coccobacilli	Beta-hemolytic (Fig. 19-11)	Catalase: 0 Oxidase: + Nitrate: 0	HACEK organism	Endocarditis, osteomyelitis, septic arthritis (<6 years)
					
		MAC: no growth			
<i>Pasteurella multocida</i>	Pleomorphic GNB or coccobacilli (Fig. 19-18A)	Small, gray, smooth, nonhemolytic MAC: no growth (Fig. 19-19, right)	Catalase: + Oxidase: + Indole: +		Animal bites (cats) Cellulitis and lymphadenitis
					
		Supplemented agar: fried-egg appearance			
<i>Streptobacillus moniliformis</i>	Pleomorphic GNB with areas of swelling	Supplemented agar: fried-egg appearance	Catalase: 0 Oxidase: 0 Indole: 0	Broth medium: puff balls (Fig. 19-16)	Rat bite fever, Haverhill fever, or epidemic arthritic erythema (ingestion)
					

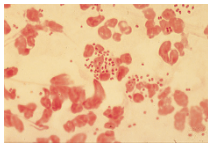


^aCHOC, chocolate agar; GN, Gram negative; GNB, Gram-negative bacilli; HACEK organisms, *Haemophilus* spp., *Aggregatibacter* spp., *Cardiobacterium* spp., *Eikenella corrodens*, and *Kingella* spp.; MAC, MacConkey agar; nitrate, nitrate reductase; SBA, sheep blood agar; +, positive; 0, negative.

Chapter 20 *Legionella*^a

Organism	Gram stain morphology	Growth characteristics	Key phenotypic characteristics for identification	Additional information	Clinical presentation
<i>Legionella pneumophila</i>	Thin GNB Not routinely detected by Gram stain Best detected by carbol fuchsin (Fig. 20-2) 	Optimal growth on BCYE (supplemented with cysteine) Incubation: up to 2 weeks Cut-glass appearance (Fig. 20-6) 	Hippurate: +	<i>L. pneumophila</i> serogroup 1: responsible for >90% of the pneumonia attributed to <i>Legionella</i> Additional tests: • DFA: low sensitivity • NAAT • Urinary antigen (serogroup 1) • Serology	Pneumonia (Legionnaires' disease) Pontiac fever, an acute, self-limiting flu-like illness Extrapulmonary diseases Transmission via aerosolized contaminated water source
<i>L. micdadei</i>	Thin GNB Not routinely detected by Gram stain Best detected by carbol fuchsin	Optimal growth on BCYE (supplemented with cysteine)	Hippurate: 0	Acid-fast-stain positive (tissue)	Pneumonia

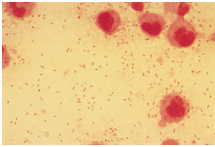
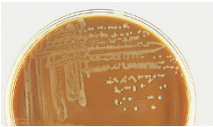
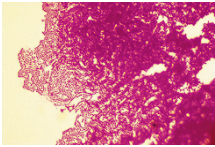
^aBCYE, buffered charcoal yeast extract; DFA, direct fluorescent-antibody test; GNB, Gram-negative bacilli; NAAT, nucleic acid amplification test; +, positive; 0, negative.

Chapter 21 *Neisseria*^a

Organism	Gram stain morphology	Growth characteristics	Key phenotypic characteristics for identification	Additional information	Clinical presentation
<i>Neisseria gonorrhoeae</i>	Often intracellular GN diplococci (kidney bean shaped) (Fig. 21-1) 	Optimize recovery with selective media (MTM) SBA: no growth CHOC: off-white colonies (Fig. 21-4, right) 	Catalase: + Oxidase: + Glucose: + Maltose: 0 Lactose: 0 Sucrose: 0	NAAT: urine and genital	Sexually transmitted diseases Disseminate: bacteremia and joint infections
<i>N. meningitidis</i>	GN diplococci (kidney bean shaped)	SBA: growth CHOC: gray colonies with surrounding green discoloration (Fig. 21-4, left) 	Catalase: + Oxidase: + Glucose: + Maltose: + Lactose: 0 Sucrose: 0	Vaccines available for serovars C, W, and Y (capsular) and B (noncapsular)	Meningitis and septicemia
<i>N. lactamica</i>	GN diplococci	Morphologically similar to <i>N. meningitidis</i>	Catalase: + Oxidase: + Glucose: + Maltose: + Lactose: + Sucrose: 0	Commensal of the upper respiratory tract especially in young children	Rare cases of meningitis and septicemia

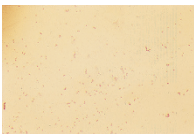
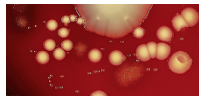
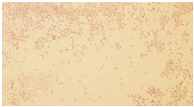
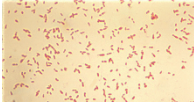
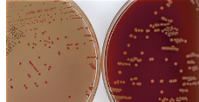

^aCHOC, chocolate agar; GN, Gram negative; MTM, modified Thayer-Martin; NAAT, nucleic acid amplification test; SBA, sheep blood agar; +, positive; 0, negative.

Chapter 22 *Haemophilus*^a

Organism	Gram stain morphology	Growth characteristics	Key phenotypic characteristics for identification	Additional information	Clinical presentation
<i>Haemophilus influenzae</i>	Small, pleomorphic, GN coccobacilli Encapsulated: V (Fig. 22-1) 	SBA: no growth Horse blood agar: nonhemolytic CHOC: gray, mucoid, and glistening (Fig. 22-3) 	Requires V and X factors Satellitism: +	Capsular vaccine to group b <i>H. influenzae</i> is available Additional tests: • Antigen detection: urine and CSF • NAAT	Conjunctivitis, sinusitis, otitis, epiglottitis, orbital cellulitis, bacteremia, and meningitis Most <i>H. influenzae</i> infections are caused by nontypeable strains
<i>H. parainfluenzae</i>	Small, pleomorphic, GN coccobacilli	Off-white to yellow, 1 to 2 mm (24 h)	Requires V factor	Part of the HACEK group	Acute otitis media, acute sinusitis, acute bacterial exacerbation of chronic bronchitis, and subacute endocarditis
<i>H. haemolyticus</i>	Small, pleomorphic, GN coccobacilli	Horse blood agar: beta-hemolytic colonies	Requires X and V factor		Can cause invasive disease
<i>H. parahaemolyticus</i>	Small, pleomorphic, GN coccobacilli	Horse blood agar: beta-hemolytic colonies	Requires V factor		Rarely causes disease
<i>H. ducreyi</i>	Small, pleomorphic, GN coccobacilli arranged as “schools of fish” (Fig. 22-2) 	Up to 5 days to grow Optimal growth: 30 to 33°C	Requires X factor		Sexually transmitted infection characterized by a painful genital soft chancre that can progress to inguinal lymphadenopathy

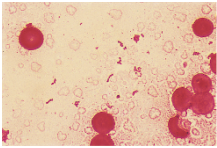

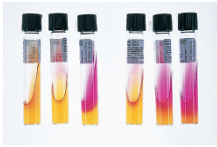
^aCHOC, chocolate agar; CSF, cerebrospinal fluid; GN, Gram negative; HACEK organisms, *Haemophilus* spp., *Aggregatibacter* spp., *Cardiobacterium* spp., *Eikenella corrodens*, and *Kingella* spp.; NAAT, nucleic acid amplification test; SBA, sheep blood agar; +, positive; 0, negative; V, variable.

Chapter 23 *Bordetella* and Related Genera*

Organism	Gram stain morphology	Growth characteristics	Key phenotypic characteristics for identification	Additional information	Clinical presentation
<i>Bordetella pertussis</i>	GN coccobacilli, faintly staining (Fig. 23-1)  Best counterstained with carbol fuchsin	Charcoal-containing transport medium for optimal recovery SBA: no growth Special media (BGA or Regan-Lowe): mercury drop-like (Fig. 23-7)  Growth rate: up to 5 days	Oxidase: + Urease: 0	Additional tests: • DFA: low sensitivity and specificity • NAAT: good sensitivity • Serology Vaccine available	Whooping cough
<i>B. parapertussis</i>	GN coccobacilli, faintly staining Best counterstained with carbol fuchsin (Fig. 23-3) 	Charcoal-containing transport medium for optimal recovery Grows on SBA BGA: brown pigmented colonies Growth rate: 2–3 days	Oxidase: 0 Urease: + (24 h)		Pertussis-like symptoms in immunocompromised patients
<i>B. bronchiseptica</i>	GN coccobacilli, faintly staining Best counterstained with carbol fuchsin	Grows on SBA and MAC Growth rate: 1–2 days	Oxidase: + Urease: + (4 h)	Mainly an animal pathogen (kennel cough in dogs)	Pertussis-like symptoms in immunocompromised patients
<i>Achromobacter xylosoxidans</i>	GN coccobacilli to small bacilli (Fig. 23-4) 	Grows on SBA and MAC (Fig. 23-13) 	Catalase: + Oxidase: +		Associated with CF patients
<i>Alcaligenes faecalis</i>	GNB	Grows on SBA and MAC SBA: green discoloration surrounding the colony (Fig. 23-14) 	Apple odor Nitrite: +		Isolated from a variety of clinical material

*BGA, Bordet-Gengou agar; CF, cystic fibrosis; DFA, direct fluorescent antibody test; GN, Gram negative; GNB, Gram-negative bacilli; MAC, MacConkey agar; NAAT, nucleic acid amplification test; SBA, sheep blood agar; +, positive; 0, negative.

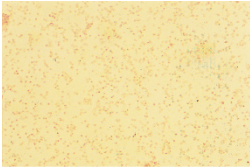
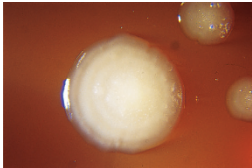
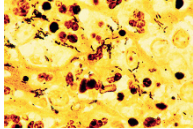
Chapter 24 *Brucella*^a

Organism	Gram stain morphology	Growth characteristics	Key phenotypic characteristics for identification	Additional information	Clinical presentation
<p><i>B. melitensis</i> (goat and sheep)</p> <p><i>B. abortus</i> (cattle)</p> <p><i>B. canis</i> (canine)</p> <p><i>B. suis</i> (swine)</p>	<p>Small, GN coccobacilli (stain faintly)</p> <p>Best counterstained with carbol fuchsin (Fig. 24-1B)</p> 	<p>Smooth colonies appear after 24 to 48 h of incubation (Fig. 24-2)</p> 	<p>Catalase: +</p> <p>Oxidase: +</p> <p>Urease: +^b (Fig. 24-4)</p>  <p>Nitrate: +</p>	<p><i>B. melitensis</i> most common in human infections</p> <p><i>Brucella</i> spp. have a very low infectious dose (<10² CFU)</p> <p>Laboratory-acquired infections are an important source of transmission</p> <p>Additional tests:</p> <ul style="list-style-type: none"> • Serology • NAAT 	<p>Intermittent fever, chills, weakness, malaise, aches, sweating, and weight loss</p> <p>Transmission mostly by ingestion of unpasteurized milk or its by-products</p>

^aGN, Gram negative; NAAT, nucleic acid amplification test; +, positive.

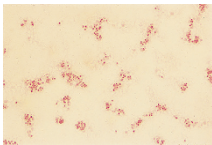

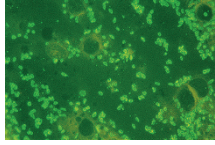
^b*B. suis* and *B. canis* hydrolyze urea rapidly (in less than 1 h), whereas *B. melitensis* and *B. abortus* take longer or may be negative.

Chapter 25 *Bartonella*^a

Organism	Gram stain morphology	Growth characteristics	Key phenotypic characteristics for identification	Additional information	Clinical presentation
<i>Bartonella bacilliformis</i>	Small, faintly stained, slightly curved GNB	Blood-enriched medium required Slow growing, up to 3 weeks on solid media	Oxidase: 0 Urease: 0	Vector: sand fly (<i>Lutzomyia</i>) Additional tests: • Serology • NAAT (<i>Bartonella</i> spp.) • Histopathology: silver stain	Carrion's disease: Oroya fever (acute hemolytic bacteremia) and verruga peruana (chronic nodular form)
<i>B. quintana</i>	Small, faintly stained, slightly curved GNB	Blood-enriched medium required Slow growing, up to 3 weeks on solid media	Oxidase: 0 Urease: 0	Vector: body louse (<i>Pediculus humanus</i>) Blood-enriched media required Additional tests: • Serology • NAAT (<i>Bartonella</i> spp.) • Histopathology: silver stain	Trench fever Bacillary angiomatosis (AIDS) Endocarditis (blood culture negative)
<i>B. henselae</i>	Small, faintly stained, slightly curved GNB (Fig. 25-1) 	Blood-enriched medium required Slow growing, up to 3 weeks on solid media Rough cauliflower-like or smaller colony with tendency to pit and adhere to the agar (Fig. 25-2B) 	Oxidase: 0 Urease: 0	Vector: flea (<i>Ctenocephalides felis</i>) Reservoir: cat Additional tests: • Serology • NAAT (<i>Bartonella</i> spp.) • Histopathology: silver stain (Fig. 25-3) 	Cat scratch disease Bacillary angiomatosis: hepatic and splenic peliosis (AIDS) Endocarditis (blood culture negative)

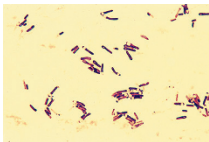

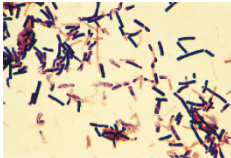


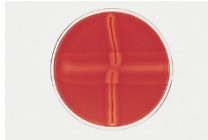
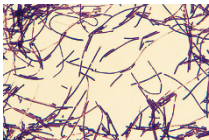

^aGNB; Gram-negative bacilli; NAAT, nucleic acid amplification test; 0, negative.

Chapter 26 *Francisella*^a

Organism	Gram stain morphology	Growth characteristics	Key phenotypic characteristics for identification	Additional information	Clinical presentation
<i>Francisella tularensis</i>	<p>Small, pleomorphic, faintly stained GN coccobacilli</p> <p>Direct Gram stain is usually negative (Fig. 26-1)</p> 	<p>Supplemented agar recovery (Thayer-Martin) (Fig. 26-3)</p>  <p>MAC: no growth SBA: scant growth in 48 h CHOC: growth in 24 h</p>	<p>Catalase: 0 or + (weakly) Oxidase: 0</p>	<p>Bioterrorism agent Highly infectious at a low CFU</p> <p>Additional tests:</p> <ul style="list-style-type: none"> • Serology • Immunohistochemical stains for tissue • NAAT <p>Slide agglutination and DFA: culture suspension (Fig. 26-2)</p> 	<p>Ulceroglandular, glandular without cutaneous lesions, oculoglandular, oropharyngeal, typhoidal without localizing signs or symptoms, and pneumonic</p> <p>Humans usually acquire infection by direct contact with infected animals or by arthropod bites</p>

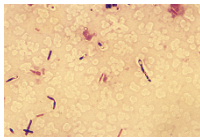

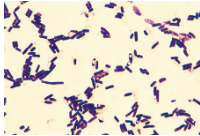

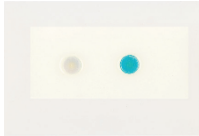
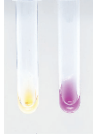
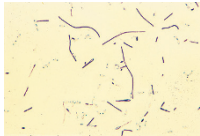
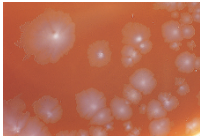
^aCHOC, chocolate agar; DFA, direct fluorescent antibody; GN, Gram negative; MAC, MacConkey agar; NAAT, nucleic acid amplification test; SBA, sheep blood agar; +, positive; 0, negative.

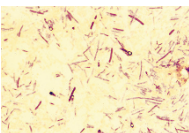
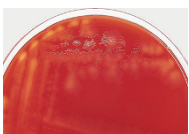
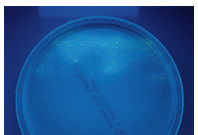


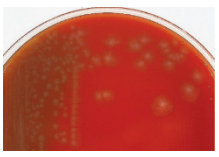

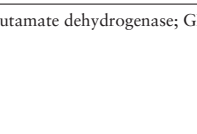
Chapter 28 *Clostridium* and *Clostridioides*

Organism	Gram stain morphology	Growth characteristics	Key phenotypic characteristics for identification	Additional information	Clinical presentation
<i>Clostridium botulinum</i>	Straight or curved, GPB, singly or in pairs Subterminal spores (Fig. 28-3) 	Gray-white with a small zone of beta-hemolysis (Fig. 28-4) 	Indole: 0 Esculin: V	Produces neurotoxin that can be detected in a variety of specimens, such as serum, stool, and food	Botulism is characterized by sudden flaccid paralysis Types of botulism: classic (foodborne), wound, infant botulism (honey), and other forms (adult intestinal toxemia)
<i>C. innocuum</i>	GPB Rare terminal spores	Gray-white to brilliant greenish colonies	Indole: 0 Esculin: + Lecithinase: 0	Vancomycin: R	Bacteremia among immunocompromised patients
<i>C. perfringens</i>	GPB or GVB, blunt ends (boxcar shaped), singly or in pairs Spores are rarely seen (central or subterminal) (Fig. 28-14A) 	Double zone of hemolysis (Fig. 28-15) 	Indole: 0 Esculin: V Lecithinase: + (Fig. 28-16) 	Reverse CAMP: + (Fig. 28-17) 	Bacteremia, traumatic myonecrosis, foodborne gastroenteritis, necrotizing enterocolitis in neonates
<i>C. ramosum</i>	Straight or curved, GVB, palisading Terminal spores are rarely produced (Fig. 28-18) 	Gray-white and nonhemolytic (Fig. 28-19) 	Indole: 0 Esculin: + Lecithinase: 0	Rifampin: R	Abscesses, peritonitis, bacteremia, and chronic otitis media

(continued)

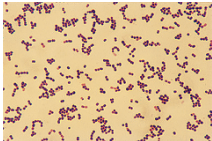

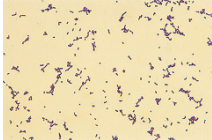
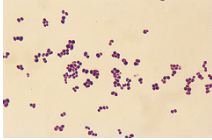
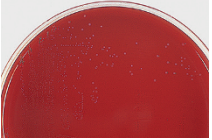
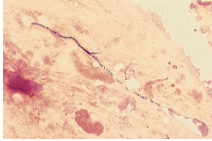

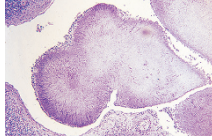
Chapter 28 *Clostridium* and *Clostridioides*^a (Continued)

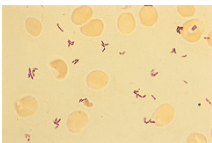


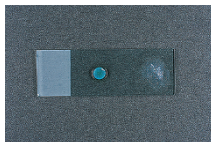

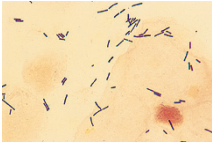
Organism	Gram stain morphology	Growth characteristics	Key phenotypic characteristics for identification	Additional information	Clinical presentation
<i>C. septicum</i>	Straight or curved, GPB or GVB, may produce long filaments Subterminal spores (Fig. 28-21) 	Gray, beta-hemolytic, swarms (like medusa heads) (Fig. 28-22) 	Indole: 0 Esculin: + Lecithinase: 0 DNase: +		Bacteremia (associated with colon cancer and other malignancies), nontraumatic myonecrosis, and neutropenic enterocolitis
<i>C. sordellii</i>	Large, GPB Subterminal and free spores (Fig. 28-23) 	Large, white-gray with lobate edges (Fig. 28-24) 	Lecithinase: + Esculin: 0 Indole: + (Fig. 28-25A)  Urease: + (Fig. 28-25B) 		Neutropenic enterocolitis Toxic shock syndrome and abortion
<i>C. tertium</i>	GVB Terminal spores when incubated anaerobically (Fig. 28-28) 	White-gray, irregular margins (Fig. 28-30) 	Aerotolerant Indole: 0 Esculin: + Lecithinase: 0	Metronidazole: R	Bacteremia, neutropenic enterocolitis

<i>C. tetani</i>	GPB or GVB, singly and in pairs Terminal spores (tennis racket) (Fig. 28-31)	Gray, irregular to rhizoid margin and can swarm (Fig. 28-32)	Indole: V Esculin: 0 Lecithinase: 0	Tetanospasmin: neurotoxin Vaccine available	Characterized by paralysis and tonic spasms
		Indole: 0 Esculin: + Lecithinase: 0 Fluoresces chartreuse (Fig. 28-9)	Toxigenic strains: genes coding for the enterotoxin TcdA (toxin A), cytotoxin TcdB (toxin B), and TcdC (hypervirulent ribotype 027/NAP1) Additional tests: • EIA: toxin A and B • NAAT • GDH • CCCNA (Fig. 28-11A)	Antibiotic-associated diarrhea and pseudomembranous colitis	
<i>Clostridioides difficile</i>	Straight, GPB in short chains Subterminal spores and free spores (Fig. 28-7)	Gray-white, nonhemolytic “Horse manure” odor when grown on solid media (Fig. 28-8)			
					

^aCCCNA, cell culture cytotoxicity neutralization assays; EIA, enzyme immunoassay; esculin, hydrolysis of esculin; GDH, glutamate dehydrogenase; GPB, Gram-positive bacilli; GVB, Gram-variable bacilli; NAAT, nucleic acid amplification test; +, positive; 0, negative; V, variable.

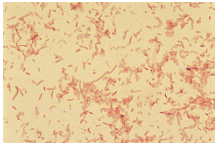
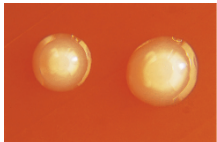
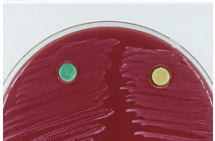
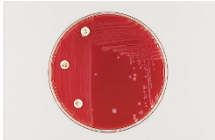
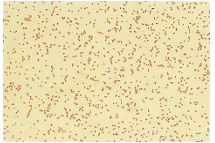
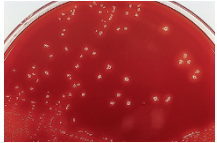
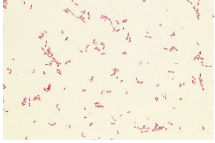
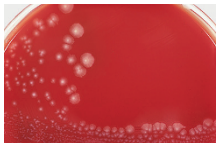

Chapter 29 *Peptostreptococcus*, *Finegoldia*, *Anaerococcus*, *Peptoniphilus*, *Cutibacterium*, *Lactobacillus*, *Actinomyces*, and Other Non-Spore-Forming, Anaerobic Gram-Positive Bacteria^a

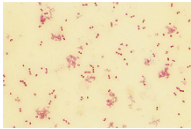

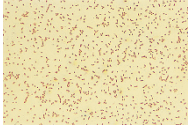
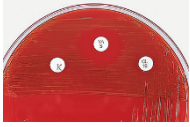
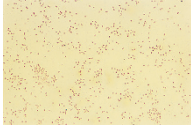


Organism	Gram stain morphology	Growth characteristics	Key phenotypic characteristics for identification	Additional information	Clinical presentation
<i>Peptostreptococcus anaerobius</i>	Pleomorphic GPC in chains (Fig. 29-6) 	Nonhemolytic Pungent sweet odor when grown on solid media	SPS: S (Fig. 29-8, left) 		Abdominal cavity and female genitourinary tract infections
<i>Parvimonas micra</i>	Small GPC in pairs or short in chains (Fig. 29-4) 	Minute colonies surrounded by a milky halo	SPS: R		Oral infections
<i>Finegoldia magna</i>	GPC in pairs or clusters (Fig. 29-2) 	Minute nonhemolytic colonies (Fig. 29-3) 	SPS: R		Endocarditis, meningitis, pneumonia, cutaneous and joint infections
<i>Actinomyces israelii</i>	GPB with branching filaments (beaded appearance) (Fig. 29-12) 	Molar tooth appearance (Fig. 29-14B) 	Modified acid-fast stain: 0 Nitrate: + Catalase: 0	Sulfur granules (Fig. 29-11) 	CNS, lower respiratory tract, genital tract (intrauterine devices), and cervicofacial infections

<i>Actinomyces odontolyticus</i>	GPB, club shaped or bifurcated ends (Fig. 29-15) 	Pink-pigmented colonies (4–10 days) (Fig. 29-16B) 	Nitrate: + Catalase: 0		Intrauterine device infections and bacteremia
<i>Cutibacterium acnes</i>	GPB, diphtheroidal or club shaped	Slow growing under microaerophilic conditions; enhanced growth anaerobically (Fig. 29-18) 	Nitrate: + Indole: + Catalase: + (Fig. 29-19) 		Acne vulgaris, prosthetic valve, ventriculoarterial shunt implants and prosthetic joint (shoulder) infections
<i>Eggerthella lenta</i>	Pleomorphic GPB (Fig. 29-22) 	Small and translucent colonies	Catalase: + Nitrate: +	Orange/red fluorescence under UV light	Bacteremia
<i>Lactobacillus</i> spp.	Slender, GPB, parallel sides and blunt ends (Fig. 29-24) 	Nonpigmented colonies	Catalase: 0 Nitrate: 0	Vancomycin: R (some species)	Bacteremia, endocarditis, intra-abdominal abscesses

*CNS, central nervous system; GPB, Gram-positive bacilli; GPC, Gram-positive cocci; R, resistant; S, susceptible; SPS, sodium polyanethol sulfonate; +, positive; 0, negative.

Chapter 30 *Bacteroides*, *Porphyromonas*, *Prevotella*, *Fusobacterium*, and Other Anaerobic Gram-Negative Bacteria^a

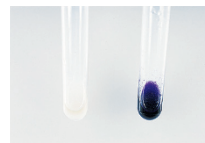
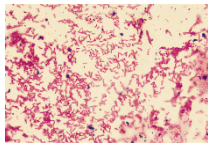
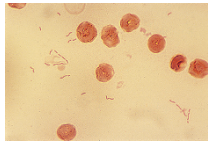
Organism	Gram stain morphology	Growth characteristics	Key phenotypic characteristics for identification	Additional information	Clinical presentation
<i>Bacteroides fragilis</i>	Irregularly staining, pleomorphic, GNB (Fig. 30-1) 	Concentric ring or whorl colonies (Fig. 30-2A) 	Esculin: + Indole: 0 (Fig. 30-5, right) 	Growth in 20% bile: + Vancomycin: R Kanamycin: R Colistin: R (Fig. 30-2B) 	Frequently isolated from blood, ulcers, abscesses, bronchial secretion, bone, intra-abdominal infections, and the head
<i>Fusobacterium nucleatum</i>	Long, thin, GNB with tapered ends (Fig. 30-12) 	Small, irregularly shaped colonies (“bread crumbs”) (Fig. 30-13) 	Vancomycin: R Kanamycin: S Colistin: S		Brain abscesses
<i>Fusobacterium necrophorum</i>	Pleomorphic, long, GNB (Fig. 30-15) 	White to tan, glistening, umbonate, circular colonies (Fig. 30-16) 	Vancomycin: R Kanamycin: S Colistin: S Lipase: + (Fig. 30-17) 		Lemierre’s syndrome: tonsillitis complicated by jugular vein thrombophlebitis, and bacteremia

<i>Prevotella</i> spp.	GN coccobacilli (Fig. 30-6)	Small, circular, shiny, gray colonies	Vancomycin: R Kanamycin: R (rarely S) Colistin: V (Fig. 30-7)	Oral infections
				
<i>Porphyromonas</i> spp.	Gram variable (Fig. 30-10)	Pigmented ^b	Vancomycin: S ^b Kanamycin: R Colistin: R (Fig. 30-11)	Isolated from oral cavity, intra-abdominal sites, vagina, amniotic fluid, skin (decubitus ulcers), blood, and brain tissue
				
<i>Veillonella</i> spp.	Tiny GNC (Fig. 30-20)	Small, opaque, nonhemolytic (Fig. 30-21)	Vancomycin: R Kanamycin: S Colistin: S Nitrate: + (Fig. 30-22)	Isolated from sites of infection, where they are typically part of a mixed culture
				

^aEsculin, hydrolysis of esculin; GN, Gram negative; GNB, Gram-negative bacilli; GNC, Gram-negative cocci; R, resistant; S, susceptible; V, variable; +, positive; 0, negative.
^b*Porphyromonas catoniae* is nonpigmented and vancomycin resistant.

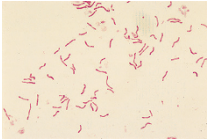

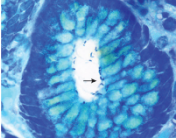
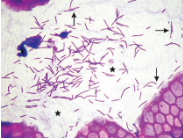
Chapter 31 *Campylobacter* and *Arcobacter*^a

Organism	Gram stain morphology	Growth characteristics	Key phenotypic characteristics for identification	Additional information	Clinical presentation
<i>Campylobacter coli</i>	GNB, curved, seagull wing shaped Carbol fuchsin or aqueous basic fuchsin as the counterstain is recommended	Requires microaerobic atmosphere (5–7% O ₂ , 5–10% CO ₂ , and 80–90% N ₂) Selective media should be used	Growth at 42°C: + Hippurate: 0 Indoxyl acetate: +	Additional tests: • Antigen detection • NAAT	Same clinical picture as <i>C. jejuni</i>
<i>C. fetus</i> subsp. <i>fetus</i>	GNB, curved, seagull wing shaped Carbol fuchsin or aqueous basic fuchsin as the counterstain is recommended (Fig. 31-2)	Requires microaerobic atmosphere (5–7% O ₂ , 5–10% CO ₂ , and 80–90% N ₂) Selective media should be used	Growth at 42°C: 0 Grows at 25°C Hippurate: 0 Indoxyl acetate: 0		Bloodstream and extraintestinal infections during pregnancy or in immunocompromised individuals
<i>C. jejuni</i> subsp. <i>jejuni</i>	GNB, curved, seagull wing shaped Carbol fuchsin or aqueous basic fuchsin as the counterstain is recommended (Fig. 31-1B)	Requires microaerobic atmosphere (5–7% O ₂ , 5–10% CO ₂ , and 80–90% N ₂) Selective media should be used (Fig. 31-5)	Growth at 42°C: + Hippurate: + (Fig. 31-9, right)	Additional tests: • Antigen detection • NAAT	Ranges from asymptomatic to severe cases with fever, abdominal cramps, and diarrhea that may be bloody and last for several days to weeks Associated with Reiter's syndrome and Guillain-Barré syndrome
<i>C. ureolyticus</i>	Small GNB	Colony morphology is variable. May pit the agar	Urease: + Growth in bile 20%: 0		Skin, soft tissue, urethral perianal and periodontal, gastrointestinal infections
<i>Arcobacter</i> spp.	Spiral-shaped GNB	Aerotolerant	Growth at 42°C: 0		Diarrhea and bloodstream infections



^aGNB, Gram-negative bacilli; hippurate, hippurate hydrolysis; NAAT, nucleic acid amplification test; +, positive; 0, negative.

Chapter 32 *Helicobacter*^a

Organism	Gram stain morphology	Growth characteristics	Key phenotypic characteristics for identification	Additional information	Clinical presentation
<i>Helicobacter pylori</i>	Spiral, curved, or straight GNB (Fig. 32-1) 	Small, nonhemolytic (Fig. 32-5A)  Poor growth in routine aerobic atmospheres	Urease: + Catalase: + Oxidase: +	Additional tests: • Serology • Stool antigen • Urea breath test • Rapid urease test Histopathology: curved bacilli (Fig. 41-71B) 	Chronic gastritis, peptic ulcer, gastric adenocarcinoma, and B-cell MALT lymphoma
<i>H. heilmannii</i> -like organism	Large, helical, tightly coiled GNB	Very poor growth <i>in vitro</i>	Urease: + Catalase: + Oxidase: +	Additional test: • Histopathology: tightly coiled bacilli (Fig. 41-72B) 	Rare in humans (0.3–6%) Peptic ulcer, gastritis, and MALT lymphoma

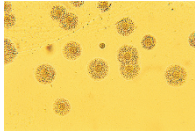
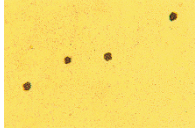

^aGNB, Gram-negative bacilli; MALT, mucosa-associated lymphoid tissue; +, positive.

Chapter 33 *Chlamydia*^a

Organism	Gram stain morphology	Growth characteristics	Key phenotypic characteristics for identification	Additional information	Clinical presentation
<i>C. trachomatis</i>	Not detected by Gram stain	Cannot be cultured on artificial media; requires living eukaryotic cells	NA	15 major serotypes: A–K, Ba, L1–L3 Additional tests: • NAAT: preferred • DFA: particularly useful for neonatal conjunctivitis • EIA: low sensitivity	Trachoma: serotypes A–C, Ba Sexually transmitted infections: serotypes D–K Lymphogranuloma venereum: serotypes L1, L2, and L3 Infant conjunctivitis and pneumonia
<i>C. pneumoniae</i>	Not detected by Gram stain	Cannot be cultured on artificial media; requires living eukaryotic cells	NA	Additional test: • NAAT: preferred	Upper and lower respiratory tract infection (pneumonia)
<i>C. psittaci</i>	Not detected by Gram stain	Cannot be cultured on artificial media; requires living eukaryotic cells	NA	Bioterrorism agent Zoonosis; primary reservoir: domestic birds	Pneumonia (psittacosis)

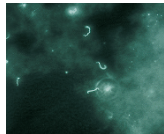
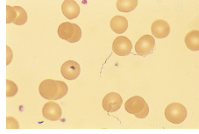
^aDFA, direct fluorescent-antibody stain; EIA, enzyme immunoassay; NA, not applicable or data not available; NAAT, nucleic acid amplification test.

Chapter 34 *Mycoplasma* and *Ureaplasma*^a



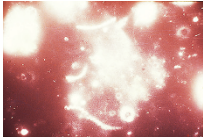
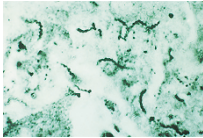
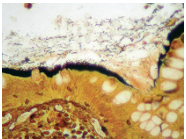
Organism	Gram stain morphology	Growth characteristics	Key phenotypic characteristics for identification	Additional information	Clinical presentation
<i>Mycoplasma pneumoniae</i>	Not stained (lacks a cell wall)	Requires specialized media Spherical colonies	NA	Additional tests: • NAAT: preferred • Serology	Atypical pneumonia Associated with autoimmune hemolytic anemia due to cold agglutinins
<i>M. hominis</i>	Not stained (lacks a cell wall)	Fried-egg appearance (Fig. 34-1) 	NA		Pelvic inflammatory disease and postabortal and postpartum fever
<i>M. genitalium</i>	Not stained (lacks a cell wall)	Requires specialized media	NA	Additional test: • NAAT: preferred	Urethritis, cervicitis, endometritis, and pelvic inflammatory disease
<i>Ureaplasma urealyticum</i>	Not stained (lacks a cell wall)	Requires specialized media Tiny (15–30 μm) (Fig. 34-3) 	Urease: + (Fig. 34-4, right) 		Urethritis and female infertility

^aNA, not applicable or data not available; NAAT, nucleic acid amplification test; +, positive.

Chapter 35 *Leptospira*, *Borrelia*, *Treponema*, and *Brachyspira*^a

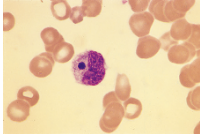

Organism	Gram stain morphology	Growth characteristics	Key phenotypic characteristics for identification	Additional information	Clinical presentation
<i>Leptospira interrogans</i>	Best counterstained with carbol fuchsin	Requires specialized media	NA	Additional tests: <ul style="list-style-type: none"> • Serology (MAT): more sensitive • Dark-field: direct wet mount (Fig. 35-1)  <ul style="list-style-type: none"> • NAAT • Histopathology: Warthin-Starry or IHC 	Septicemia phase: <ul style="list-style-type: none"> • Asymptomatic (most common) • Fever, chills, headaches, abdominal pain, myalgias (calf and lumbar), and conjunctival suffusion Immune phase: <ul style="list-style-type: none"> • Jaundice, renal failure, arrhythmias, pulmonary symptoms, aseptic meningitis, photophobia; adenopathy and hepatosplenomegaly • Weil's disease: hepatorenal failure Transmission: direct or indirect exposure to urine of infected animals (rodents) Entry: skin cuts or abrasions, mucosa and conjunctiva
<i>Borrelia recurrentis</i>		Requires specialized media	NA	Additional tests: <ul style="list-style-type: none"> • Blood smear: Giemsa or Wright's stain • Serology • NAAT Vector: <i>Pediculus humanus</i> (louse)	Louse-borne relapsing fever
<i>B. hermsii</i> <i>B. turicatae</i> <i>B. parkeri</i>	Not stained	Require specialized media	NA	Additional test: <ul style="list-style-type: none"> • Blood smear: Giemsa or Wright's stain (Fig. 35-4) 	Tick-borne relapsing fever

Vector: *Ornithodoros* (soft tick)

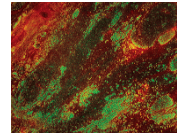
<i>B. burgdorferi</i>	Coiled GNB (Fig. 35-3) 	Culture is rarely performed	NA	Additional tests: • Serology: Two-step approach • NAAT • Blood smear: undetectable Vector: <i>Ixodes</i> (tick) (Fig. 35-6) 	Lyme disease: erythema migrans, neurologic (facial nerve palsy), and cardiac (atrioventricular block) involvement, large joint arthritis (knee)
<i>Treponema pallidum</i>	Not stained	Not culturable; grows in rabbit testes	NA	Additional tests: • Dark-field: chancre (Fig. 35-7)  • Serology: treponemal and non-treponemal tests • NAAT • Histopathology: Warthin-Starry stain or IHC (Fig. 35-8) 	Primary stage: chancre (firm, painless) Secondary stage: skin rash (soles and palms), condyloma latum Tertiary stage: gummas; can affect cardiovascular system and CNS Congenital
<i>Brachyspira</i> spp.	Poorly stained	Light gray and weakly beta-hemolytic	Biochemical reactions are unreliable	Histopathology: false brush border (Fig. 35-14) 	Chronic diarrhea and abdominal pain: children, HIV+ individuals, and MSM Healthy adults are carriers

^aCNS, central nervous system; GNB, Gram-negative bacilli; IHC, immunohistochemistry; MAT, microscopic agglutination test; MSM, men who have sex with men; NA, not applicable or data not available; NAAT, nucleic acid amplification test.

Chapter 36 *Rickettsia*, *Orientia*, *Ehrlichia*, *Anaplasma*, and *Coxiella*^a

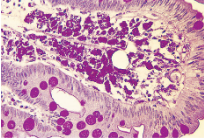
Organism	Gram stain morphology	Growth characteristics	Key phenotypic characteristics for identification	Additional information	Clinical presentation
<i>Rickettsia rickettsii</i>	Faint GN, obligately intracellular bacteria Best stained with Giemsa and Gimenez stains	Need cell culture to cultivate	NA	Additional tests: • NAAT: preferred • Serology • Cell culture: rarely performed • Histopathology: IHC or direct immunofluorescence Vector: <i>Dermacentor</i> (tick)	Rocky Mountain spotted fever
<i>R. prowazekii</i>	Faint GN, obligately intracellular bacteria Best stained with Giemsa and Gimenez stains	Need cell culture to cultivate	NA	Additional tests: • NAAT: preferred • Serology • Cell culture: rarely performed • Histopathology Vector: <i>Pediculus humanus</i> (louse)	Epidemic typhus Brill-Zinsser disease (recurrent form)
<i>R. typhi</i>	Faint GN, obligately intracellular bacteria Best stained with Giemsa and Gimenez stains	Need cell culture to cultivate	NA	Additional tests: • NAAT: preferred • Serology • Cell culture: rarely performed • Histopathology • Peripheral blood smear: Morulae within mononuclear cells Vector: <i>Xenopsylla cheopis</i> (flea)	Endemic or murine typhus
<i>Ehrlichia chaffeensis</i>	Small GN, obligately intracellular bacteria Best stained with Giemsa and Gimenez stains	Need cell culture to cultivate	NA	Additional tests: • NAAT • Serology: IFA (gold standard) • Peripheral blood smear: morulae within monocytes (Fig. 36-2B)  Cell culture: rarely performed Vector: <i>Amblyomma americanum</i> (lone star tick) (Fig. 36-7) 	Ehrlichiosis

<i>E. ewingii</i>	Small GN, obligately intracellular bacteria Best stained with Giemsa and Gimenez stains	Need cell culture to cultivate	NA	Additional test: • Broad-range NAAT Vector: <i>Amblyomma americanum</i>	Human ewingii ehrlichiosis
<i>Anaplasma phagocytophilum</i>	Small GN, obligately intracellular bacteria Best stained with Giemsa and Gimenez stains	Need cell culture to cultivate	NA	Additional tests: • NAAT • Serology: IFA (gold standard) • Peripheral blood smear: morulae within monocytes • Cell culture: rarely performed Vector: <i>Ixodes</i> species (tick)	Human granulocytic anaplasmosis
<i>Coxiella burnetii</i>	Small, GN, obligately intracellular bacteria Best stained with Giemsa and Gimenez stains	Need cell culture to cultivate	NA	Bioterrorism agent Additional tests: • Serology: phase I and phase II • NAAT • Histopathology • Cell culture (Fig. 36-4)	Acute and chronic Q fever Most common presentations are pneumonia, hepatitis, and fever Major complication: endocarditis Transmitted through unpasteurized milk, products of conception, or excreta of infected cattle, sheep, and goats
<i>Orientia tsutsugamushi</i>	Obligately intracellular bacteria Best stained with Giemsa and Gimenez stains	Need cell culture to cultivate	NA	Histopathology: fibrin ring granuloma (bone marrow or liver) Reservoir: cattle, sheep and goats, dogs, cats, and rabbits Endemic in the “tsutsugamushi triangle,” which extends from Japan to Pakistan, Afghanistan, and Australia Additional tests: • IHC • NAAT • Serology Vector: mites	Scrub typhus



^aGN, Gram negative; IFA, indirect immunofluorescence assay; IHC, immunohistochemical staining; NA, not applicable or data not available; NAAT, nucleic acid amplification test.

Chapter 37 *Tropheryma whipplei*^a

Organism	Gram stain morphology	Growth characteristics	Key phenotypic characteristics for identification	Additional information	Clinical presentation
<i>T. whipplei</i>	Poorly stained GPB	Culture can take 4–6 weeks to grow and is rarely done	NA	<p>Histopathology: foamy macrophages within intestinal mucosa (Fig. 37-1B)</p>  <ul style="list-style-type: none"> • PAS: + • AFB: 0 • NAAT 	Whipple's disease: diarrhea, weight loss, abdominal pain, lymphadenopathy, fever, arthralgia, skin pigmentation, and neurological signs

^aAFB, acid-fast bacilli; GPB, Gram-positive bacilli; NA, not applicable or data not available; NAAT, nucleic acid amplification test; PAS, periodic acid-Schiff.

Index

Note: Page numbers followed by “f” indicate a figure; page numbers followed by “t” indicate a table.

A

- A7 agar
 Mycoplasma hominis, 279f
 Ureaplasma urealyticum, 280f
- Abiotrophia*, 30, 31t
 chocolate agar, 34f
 fast facts, 374t
 Gram stain, 32f
 satellite growth, blood agar, 35f
- Achromobacter* spp., 198
- Achromobacter xylosoxidans*
 fast facts, 401t
 Gram stain, 199f
 MacConkey agar, 202f
 sheep blood agar, 202f
- Acid-fast stain
 auramine fluorochrome, 344f
 Kinyoun stain of sputum specimen, 344f
 Nocardia, 64f, 341f
 Nocardia asteroides, 64f
- Acidovorax* spp., 150, 152t
- Acinetobacter* spp., 157–158, 162t
 antimicrobial susceptibility testing, 163f
 disk diffusion method, 163f
 Gram stain, 162f
- Acinetobacter baumannii*
 fast facts, 395t
- Acridine orange stain, 344f
 Borrelia hermsii, 287f
- Actinobacillus* spp., 168–169
 differentiating characteristics, 171t
 fast facts, 396t
 reaction on urea agar and in mannitol broth, 174f
- Actinobacillus equuli*, on triple sugar iron (TSI) agar slant, 174f
- Actinobacillus hominis*, blood agar, 173f
- Actinobacillus ureae*, blood agar, 173f
- Actinobacter baumannii*, blood agar, 163f
- Actinobacter haemolyticus*, blood agar, 163f
- Actinobacteria*, 239
- Actinomadura* spp., 62, 63
 fast facts, 380t
- Actinomadura latina*, 63
- Actinomadura madurae*, 63
 decomposition, 63t
 Nocardia ID Quad plate, 67f
 Sabouraud dextrose agar, 66f
- Actinomadura pelletieri*,
 decomposition, 63t
- Actinomyces* spp., 239–241
 characteristics, 214t, 242t
- Actinomyces israelii*
 characteristics, 242t
 fast facts, 408t
 Gomori methenamine silver stain, 246f
 Gram stain, 220f
 mature colonies, on CDC agar, 247f
 young colonies, on CDC agar, 247f
- Actinomyces odontolyticus*
 CDC agar, 248f
 characteristics, 242t
 fast facts, 409t
 Gram stain, 247f
- Actinomycosis, pulmonary, 362f
- Adenine, 307, 311f, 312f
- ADH. See Arginine dihydrolase (ADH)
- Adonitol (ADON), *Klebsiella*, *Enterobacter*, *Serratia* and *Citrobacter*, 123f
- Aerococcus*, 30, 31
- Aerococcus sanguinicola*, 30
- Aerococcus urinae*, 30
 bile-esculin agar slants, 33f
 blood agar, 32f
 fast facts, 374t
 production of PYR and LAP by, 33f
- Aerococcus urinaehominis*, 30
- Aerococcus viridans*, 30
 blood agar, 32f
 fast facts, 374t
 Gram stain, 32f
 production of PYR and LAP by, 33f
- Aeromonas* spp., 141–142
 fast facts, 392t
- Aeromonas caviae*, 141–142
 API 20E system, 144f
 CIN agar, 144f
 fast facts, 392t
- Aeromonas hydrophila*, 141–142
 API 20E system, 144f
 blood agar, 143f
 fast facts, 392t
 Gram stain, 143f
 Hektoen agar, 143f
 inoculated into 6.5% NaCl broth, 140f
 inoculated on nutrient agar, 140f
 MacConkey agar, 143f
- Aeromonas popoffii*, 141, 142t
- Aeromonas veronii*, 141, 142t
 fast facts, 392t
- Aerotolerance test, 241
 Cutibacterium acnes, 248f
 Gram-positive bacilli, 242t
- Agglutination test, *Brucella* spp., 206f
- Aggregatibacter* spp., 169, 191
 differentiating characteristics, 171t–172t
- Aggregatibacter actinomycetemcomitans*, 169
 blood agar, 173f
 fast facts, 396t
 Gram stain, 173f
- Aggregatibacter aphrophilus*, 169
 fast facts, 396t
- AIDS, 267
- Alcaligenes* spp., 198
- Alcaligenes faecalis*
 fast facts, 401t
 MacConkey agar, 202f
 sheep blood agar, 202f

- Alere PBP2a lateral flow assay, methicillin-resistant *Staphylococcus aureus*, 7f
- Amblyomma americanum* (lone star tick), 292, 296f
- American College of Obstetricians and Gynecologists, 12
- American Society for Microbiology, 56, 130
- Amplicons, 320f
- Amygdalin (AMY), *Aeromonas caviae*, 144f
- Anaerobic, non-spore-forming Gram-positive bacilli, 239–242
- Anaerobic bacteria, 213
- biochemically based identification minisystem, 222f
 - characteristics of anaerobes on Gram stain morphology, 214t
 - direct detection, 214
 - identification, 215–216
 - preexisting enzyme-based identification minisystem, 222f
 - presumptive identification of anaerobes, 215t
 - RapID ANA II system, 222f
 - recommended media for anaerobic culture, 215t
 - specimen collection and transport, 213, 216f
 - specimen processing, 214–215
- Anaerobic environment, GasPak EZ gas-generating pouch system, 217f
- Anaerobic Gram-Negative ID Quad system, 253, 257f
- Anaerobic Gram-positive cocci, 237–239
- Anaerobic jar, 217f
- Anaerobic organisms, long, slender, pleomorphic, Gram-negative bacilli resembling, 340f
- Anaplasma* spp., 291–293
- Anaplasma phagocytophilum*, 292t
- fast facts, 419t
- Andrade's broth, biochemical test, 349f
- Anginosus* (*milleri*) group, production of BGUR, 22f
- Anthrax, 54–55
- Antimicrobial susceptibility testing (AST), 299–301, 330
- automated AST, 302f
 - disk diffusion (Kirby-Bauer), 301f
 - D test, 300, 303f
 - Etest, 299, 302f
 - Kirby-Bauer using Mueller-Hinton blood agar, 301f
 - MIC testing by microdilution, 299, 301f
 - modified carbapenem inactivation method (mCIM), 304f
 - NG-Test CARBA 5 phenotypic assay for carbapenemase detection, 305f
 - phenotypic test for β -lactamase production, 305f
 - phenotypic test for ESBL (extended-spectrum β -lactamase), 300, 303f
 - screen plate for vancomycin-resistant *Enterococcus* spp., 302f
 - synergy testing of *Enterococcus* spp., 306f
 - see also* Total laboratory automation (TLA)
- APAS Independence, artificial intelligence technology, 330–331, 336f
- API 20A system
- identification of anaerobic organisms, 222f
- API 20E system, 100f
- Aeromonas caviae*, 144f
 - Aeromonas hydrophila*, 144f
 - Bacillus cereus*, 61f
 - Citrobacter amalonaticus*, 121f
 - Citrobacter freundii*, 121f
 - Cronobacter sakazakii*, 121f
 - Enterobacter* (*Klebsiella*) *aerogenes*, 120f, 121f
 - Enterobacteriales*, 100f
 - Enterobacter cancerogenus*, 120f
 - Enterobacter cloacae*, 120f, 121f
 - Hafnia alvei*, 128f
 - Morganella morganii*, 125f, 126f
 - Pantoea agglomerans*, 121f
 - Pasteurella multocida*, 179f
 - Proteus mirabilis*, 125f
 - Proteus vulgaris*, 125f
 - Providencia alcalifaciens*, 126f
 - Providencia rettgeri*, 126f
 - Providencia stuartii*, 126f
 - Salmonella enterica*, 112f
 - Salmonella* serotype Typhi, 112f
 - Shigella sonnei*, 132f
 - Vibrio alginolyticus*, 139f
 - Yersinia enterocolitica*, 132f
- API 20 Strep test, *Enterococcus*, 28f
- API Coryne system
- Corynebacterium diphtheriae* by, 44f
 - Corynebacterium pseudodiphtheriticum*, 45f
- API NH identification system, 190f
- API Staph identification system, *Staphylococcus* spp., 10f
- Arabinose reaction
- Bacteroides fragilis*, 254t
 - Citrobacter*, 123f
 - Enterobacter*, 123f
 - Gram-negative bacilli, 254t
 - Klebsiella*, 123f
 - Salmonella*, 106t
 - Serratia*, 116t, 123f
- Arabinose utilization, 27f
- Arber, Werner, 308
- Arcanobacterium haemolyticum*, 37, 40t
- blood agar, 46f
 - clinical infections and characteristics, 39t
 - fast facts, 377t
 - reverse CAMP (inhibition) test for, 47f
- Arcobacter* spp., 261, 262
- fast facts, 412t
- Arginine dihydrolase (ADH)
- Aeromonas* spp., 142t
 - Bacillus* differentiation, 56t
 - Enterobacter*, 115t, 119f, 120f, 121f
 - Enterobacteriales* members, 93t, 94t
 - Pantoea*, 115t
 - Photobacterium damsela*, 136t
 - Pseudomonas* spp., 146t
 - Vibrionaceae*, 136t
- Arthrobacter*, 40t
- Arylsulfatase test, *Mycobacterium*, 73t, 87f
- Asaia* spp., 161, 162t
- Aston, Francis W., 309
- Atopobium* spp., 239
- Auramine fluorochrome, 344f
- Auramine O, 344f
- Auramine stain
- Mycobacterium avium-Mycobacterium intracellulare*, 75f
 - Mycobacterium tuberculosis*, 74f
- Automation. *See* Total laboratory automation (TLA)
- Avery, Oswald, 307
- Azospirillum* spp., 161, 162t
- B**
- Babbage, Charles, 310
- Bacillus* spp., 54–56
- differentiation, 56t
- Bacillus anthracis*, 54–56
- blood agar, 58f
 - differentiation, 55t, 56t
 - DRA assay, 58f
 - fast facts, 379t
 - Gram stain, 56f
 - India ink stain, 57f
 - M'Fadyean stain, 57f
 - motility test differentiating, 59f
 - spore stain, 57f
 - urea agar slant, 56t
- Bacillus cereus*, 54, 55t, 56
- API 20E system for identification, 61f
 - blood agar, 59f
 - differentiation, 55t, 56t
 - egg yolk reaction, 60f
 - fast facts, 379t
 - Gram stain, 57f
 - M'Fadyean stain, 57f

- Bacillus licheniformis*, 54, 56
 blood agar, 59f
 differentiation, 56t
- Bacillus megaterium*, 54
 differentiation, 56t
- Bacillus mycoides*, 54, 56
 blood agar, 60f
- Bacillus pumilus*, 54
 differentiation, 56t
- Bacillus simplex*, 54, 56
- Bacillus stearotherophilus*,
 pyrosequencing, 327f
- Bacillus subtilis*, 54
 blood agar, 60f
 differentiation, 56t
 egg yolk reaction, 60f
- Bacillus thuringiensis*, 54
 differentiation, 56t
- Bacitracin susceptibility, 12
Micrococcus luteus, 9f
Staphylococcus epidermidis, 9f
Streptococcus pyogenes, 9f, 20f
- BACTEC MGIT (mycobacterial growth
 indicator tube), 300
- Bacteremia, 237
- Bacteria
 Gram staining, 338
 molecular diagnosis of infections,
 307–310
see also Anaerobic bacteria
- Bacteroides* spp., 214, 237
 Brucella agar with hemin and vitamin
 K, 348f
 characteristics, 214t, 254t
 Gram stain with carbol fuchsin,
 343f
 kanamycin-vancomycin-brucella-laked
 sheep blood agar, 349f
 spot indole test, 256
- Bacteroides bile esculin* (BBE) agar,
 215t, 253
Bacteroides fragilis, 255f
Bacteroides vulgatus, 255f
Fusobacterium mortiferum, 260f
- Bacteroides fragilis*
 API 20A system, 222f
 disk pattern, 220f
 fast facts, 410t
 Gram stain, 219f
 MALDI-TOF MS, 310
 preliminary identification, 218f
 RapID ANA II system, 222f
- Bacteroides fragilis* group, 252
 BBE agar, 255f
 CDC agar, 255f
 characteristics, 254t
 Gram stain, 254f
 growth on primary media, 218f
 KVLB agar, 255f
 presumptive identification, 215t
 presumptive identification using
 antimicrobial disks, 255f
 Quad plates, 257f
- Bacteroides ovatus*, 254
- Bacteroides thetaiotaomicron*, 254t, 256f
- Bacteroides ureolyticus*
 presumptive identification, 215t
 nitrate disk test, 260f
- Bacteroides vulgatus*, 254t
 BBE agar, 255f
- BactiCard, streptococci
 identification, 23f
- Bactracin susceptibility test, presumptive
 identification of *Streptococcus*
pyogenes (group A), 20
- Baltimore, David, 308
- Bartonella* spp., 207–208
 MicroScan Rapid Anaerobe Panel, 208
- Bartonella bacilliformis*, 207
 fast facts, 403t
- Bartonella henselae*, 207
 cat scratch disease by, 364f
 colonies, 209f
 fast facts, 403t
 Gram stain, 208f
 Warthin-Starry silver stain of lymph
 node, 209f
- Bartonella quintana*, 207
 fast facts, 403t
- Basic fuchsin
Brucella spp., 204t
- BBL CHROMagar, plating media, 247f
- BBL Crystal Enteric/Nonfermenter ID
 system, 99f
- BBL selective agar, *Clostridioides*
difficile, 229f
- BBL Taxo urea differentiation disk, 266f
- BBL Trypticase soy agar, plating
 media, 347f
- BCSA (*Burkholderia cepacia* selective
 agar), 151
- BCYE. *See* Buffered charcoal-yeast
 extract (BCYE) agar
- BD BACTEC MGIT, 90f
- Beta-lysin disk, CAMP test using, 21f
- BGA. *See* Bordet-Gengou agar (BGA)
- BGUR test (β -D-glucuronidase), 13
 identifying streptococci, 22f
- Bifidobacterium* spp., 239–241
 characteristics, 242t
- Bifidobacterium dentium*, 240–241
 CDC agar, 249f
 Gram stain, 249f
- Bile esculin agar
Aerococcus urinae, 33f
Bacteroides fragilis, 349f
 biochemical test, 350f
Enterococcus faecalis, 33f
Enterococcus faecium, 22f
Streptococcus bovis, 22f, 33f
- Bile solubility test, identification of
Streptococcus pneumoniae, 21f
- BinaxNOW Legionella Urinary Antigen
 Test, 183f
- Biochemical tests, 349f–357f
 Andrade's broth, 349f
 bile esculin agar, 350f
 catalase test, 350f
 citrate utilization, 351f
 coagulase slide and tube test, 351f
 decarboxylase-dihydrolase test, 352f
 DNase test, 352f
 gelatin hydrolysis test, 353f
 hippurate hydrolysis test, 353f
 indole test, 353f
 lead acetate test, 354f
 methyl red test, 354f
 motility test, 354f
 nitrate test, 354f
 o-nitrophenyl- β -D-galactopyranoside
 test, 355f
 oxidase test, 355f
 phenylalanine deaminase test, 355f
 L-pyrrolidonyl- β -naphthylamide
 test, 355f
 triple sugar iron agar, 356f
 urease test, 357f
 Voges-Proskauer (VP) test, 357f
- Biochemically based minisystem, anaerobic
 organism identification, 222f
- Biotyping, *Haemophilus influenzae*, 196f
- Bismuth sulfite agar, *Salmonella* serotype
 Typhi, 110f
- Blood agar
Abiotrophia, 35f
Abiotrophia on, containing
 pyridoxal, 35f
Acinetobacter baumannii, 163f
Acinetobacter haemolyticus, 163f
Actinobacillus hominis, 173f
Actinobacillus ureae, 173f
Aerococcus urinae, 32f
Aerococcus viridans, 32f
Aeromonas hydrophila, 143f
Aggregatibacter
actinomycetemcomitans, 173f
Arcanobacterium haemolyticum, 46f
Bacillus anthracis, 58f
Bacillus cereus, 59f
Bacillus licheniformis, 59f
Bacillus mycoides, 60f
Bacillus subtilis, 60f
 beta-, alpha-, and gamma-hemolysis
 on, 17f
Bordetella spp., 198t
Bordetella bronchiseptica, 201f
Brucella abortus, 205f
Burkholderia cepacia, 153f
Campylobacter fetus, 264f
Cardiobacterium hominis, 176f

- Blood agar (*cont'd*)
Chromobacterium violaceum, 177f
Chryseobacterium indologenes, 167f
Comamonas spp., 155f
Corynebacterium diphtheriae, 42f
Corynebacterium diphtheriae on, with fosfomycin disk, 42f
Corynebacterium jeikeium, 44f
Corynebacterium pseudodiphtheriticum, 45f
Corynebacterium urealyticum, 45f
Corynebacterium xerosis, 46f
Cronobacter sakazakii, 122f
Eikenella corrodens, 175f
Enterobacter cloacae, 122f
Enterococcus casseliflavus, 26f
Enterococcus faecium, 18f
Erysipelothrix rhusiopathiae, 52f
Flavobacterium odoratum, 164f
Gardnerella vaginalis, 47f
Gemella spp., 34f
Haemophilus haemolyticus, 196f
Haemophilus influenzae, 194f, 196f
Kingella kingae, 176f
Klebsiella pneumoniae, 95f
Klebsiella pneumoniae subsp. *ozaenae*, 122f
Leuconostoc, 33f
Listeria spp., 50f
Methylobacterium spp., 166f
Micrococcus luteus, 5f
Myroides spp., 164f
Pasteurella multocida, 178f
 plating media, 345f
Plesiomonas shigelloides, 128f
Proteus spp., 96f
Proteus mirabilis, 124f
Pseudomonas aeruginosa, 147f
Pseudomonas aeruginosa, mucoid, 148f
Pseudomonas stutzeri, 148f
Psychrobacter phenylpyruvicus, 164f
Ralstonia pickettii, 155f
Rhodococcus equi, 51f, 68f
Serratia spp., 96f
Serratia rubidaea, 122f
Shewanella putrefaciens, 165f
Sphingomonas paucimobilis, 165f
Staphylococcus aureus, 4f, 51f
Staphylococcus epidermidis, 5f
Staphylococcus lugdunensis, 5f
Stenotrophomonas maltophilia, 154f
Streptococcus spp., 11
Streptococcus agalactiae, 17f, 19f
Streptococcus bovis group (group D), 18f
Streptococcus constellatus, 17f
Streptococcus pneumoniae, 18f
Streptococcus pyogenes, 17f, 345f
 vancomycin-dependent *Enterococcus faecalis*, 26f
 vancomycin-resistant
Leuconostoc, 34f
Vibrio alginolyticus, 137f
Vibrio cholerae, 137f
Vibrio mimicus, 140f
Vibrio parahaemolyticus, 138f
Yersinia enterocolitica, 96f, 131f
Yersinia pestis, 133f
 Blood culture broth
Eikenella corrodens, 175f
Pseudomonas aeruginosa, 147f
Bordetella spp., 197–198
 BGA, 201f
 characteristics, 198t
 charcoal-containing transport medium for recovery, 200f
 urea agar slants, 202f
Bordetella bronchiseptica
 BGA, 201f
 blood agar, 201f
 fast facts, 401t
 MacConkey agar, 201f
 urea agar slants, 202f
Bordetella parapertussis, 197, 198
 BGA, 201f
 fast facts, 401t
 Gram stain, with carbol fuchsin, 199f
 urea agar slants, 202f
Bordetella pertussis, 197–198
 BGA, 200f, 201f
 DFA stain for, 199f
 fast facts, 401t
 Gram stain, 199f
 Gram stain, with carbol fuchsin, 199f
 helicase-dependent amplification, 326f
 Regan-Lowe agar, 200f, 201f
 urea agar slants, 202f
 Bordet-Gengou agar (BGA), 197–198
Bordetella bronchiseptica, 201f
Bordetella parapertussis, 201f
Bordetella pertussis, 200f, 201f
 culture of nasopharyngeal specimen, 201f
Borrelia spp., 282–283
Borrelia burgdorferi, 282, 292
 fast facts, 417t
 Gram stain, 286f
Ixodes pacificus ticks, 287f
Borrelia hermsii, 282
 fast facts, 416t
 peripheral blood stained with acridine orange, 287f
 Wright-stained peripheral blood smear containing, 286f
Borrelia lonestarii, 296f
Borrelia parkeri, 282
 fast facts, 416t
Borrelia recurrentis, 282
 fast facts, 416t
Borrelia turicatae, 282
 fast facts, 416t
 Boyer, Herbert W., 308
Brachyspira spp., 283–285
 fast facts, 417t
 intestinal spirochetosis, 364f
 Warthin-Starry silver stain, 285, 289f
Brevibacterium spp., 37, 40t
 clinical infections and characteristics, 39t
Brevundimonas spp., 150
 key characteristics, 152t
 Brill-Zinsser disease, 290
Brochothrix, 49
 Broth medium, *Streptobacillus moniliformis*, 177f
 Brown and Hopps stain. *See* Modified Brown and Hopps stain
 Brucella agar, 215t
Bacteroides with hemin and vitamin K, 348f
Clostridium perfringens, 231f
Brucella spp., 203–204
 differentiation, 204t
 Gram stain, 204f
 Gram stain with carbol fuchsin, 343f
 production by H₂S by, 206f
 serological testing for, 206f
 urea hydrolysis by, 206f
Brucella abortus, 203, 204t
 chocolate agar, 205f
 enhancement of growth by CO₂, 205f
 fast facts, 402t
Brucella canis, 203, 204t
 fast facts, 402t
Brucella melitensis, 203, 204t
 fast facts, 402t
Brucella suis, 203, 204t
 fast facts, 402t
 Brucellosis, 203
 Bubonic plague, 129
 Buffered charcoal-yeast extract (BCYE) agar, 180
Legionella, 182f, 183f
Legionella pneumophila, 183f
Methylobacterium spp., 166f
 sputum specimen on, 182f
 Buffy coat preparation, *Ehrlichia chaffeensis*, 294f
Burkholderia, 150–151, 152t
Burkholderia cepacia, 150
 blood agar, 153f
 fast facts, 394t
 key characteristics, 152t
 MacConkey agar, 153f
 by RapID NF Plus system, 154f

- triple sugar iron (TSI) agar slant, 153f
urea and mannitol reactions for, 155f
- Burkholderia mallei*, 150, 152t
fast facts, 394t
- Burkholderia pseudomallei*, 150, 152t
fast facts, 394t
- Butyrate esterase, *Neisseria*, 185t
- C**
- CAMP test (Christie, Atkins, Munch-Petersen), 12
disks with beta-lysin, 21f
identification of *Streptococcus agalactiae*, 20f
Listeria spp., 51f
reverse CAMP for *Arcanobacterium haemolyticum*, 47f
reverse CAMP for *Clostridium perfringens*, 232f
- Campy BAP medium, *Campylobacter jejuni*, 264f
- Campy CSM medium, *Campylobacter jejuni*, 264f
- Campylobacter* spp., 261–262
agar, 25
curved, pleomorphic, Gram-negative bacilli, 340f
GasPak EZ gas-generating pouch system, 263f
Gram stain with carbol fuchsin, 343f
ImmunoCard STAT! Campy, 265f
Para-Pak C&S (culture and sensitivity) system, 263f
- Campylobacter coli*, 261
fast facts, 412t
- Campylobacter fetus*, 261–262
blood agar, 264f
chocolate agar, 264f
fast facts, 412t
Gram stain, from blood culture, 263f
- Campylobacter jejuni*, 261
Campy BAP medium, 264f
Campy SCM medium, 264f
fast facts, 412t
Gram stain, 262f
hippurate hydrolysis test for, 265f, 353f
triple slant iron (TSI) slant with lead acetate strip, 265f
- Campylobacter*-like organism (CLO) test, 268
Helicobacter pylori, 271f
- Campylobacter ureolyticus*
CDC agar, 266f
fast facts, 412t
urea test for presumptive identification, 266f
- Candida* spp., fluorescent *in situ* hybridization, 318f
- Candle jar, agar plates, 187f
- Capnocytophaga* spp., 169
chocolate agar, 175f
differentiating characteristics, 172t
fast facts, 396t
Gram stain, 174f
- Capnocytophaga canimorsus*, 169
fast facts, 396t
- Carbapenem-resistant *Enterobacteriales* (CRE), 113
- Carbol fuchsin counterstain, Gram stain with, 343f
- Cardiobacterium* spp., 169
differentiating characteristics, 172t
- Cardiobacterium hominis*
blood agar, 176f
fast facts, 396t
Gram stain, 176f
indole reaction, 176f
- Carrot broth, *Streptococcus agalactiae*, 19f
- Catalase test
Bacteroides fragilis, 254t
biochemical test, 350f
Cutibacterium acnes, 249f
Gram-negative bacilli, 254t
Gram-positive bacilli, 242t
Helicobacter spp., 268t
mycobacteria, 73t, 87f
- Cat scratch disease, 207, 209f, 364f
- CDC agar
Actinomyces israelii, 247f
Actinomyces odontolyticus, 248f
Bacteroides fragilis, 255f
Bifidobacterium dentium, 249f
Campylobacter ureolyticus, 266f
Clostridioides difficile, 228f
Clostridioides difficile under UV light, 229f
Clostridium bifermentans, 226f
Clostridium botulinum, 227f
Clostridium clostridioforme, 227f
Clostridium ramosum, 232f
Clostridium septicum, 233f
Clostridium sordellii, 234f
Clostridium sporogenes, 235f
Clostridium tertium, 236f
Clostridium tetani, 236f
Eggerthella lenta, 250f
Fingoldia magna, 243f
Fusobacterium necrophorum, 259f
Fusobacterium nucleatum, 258f
Lactobacillus spp., 250f
Parvimonas micra, 244f
Peptostreptococcus anaerobius, 244f
Porphyromonas spp., 257f
Prevotella spp., 257f
Veillonella parvula, 260f
- Cellulomonas* spp., 37, 40t
clinical infections and characteristics, 39t
- Cellulosimicrobium* spp., 37, 40t
clinical infections and characteristics, 39t
- Centers for Disease Control and Prevention (CDC), 211, 301
Clostridium botulinum, 225
identification of anaerobic bacteria, 253
- Cervista molecular assay, 322f
- Charcoal-containing transport medium, *Bordetella* spp., 200f
- Chargaff, Edwin, 307
- Charpentier, Emmanuelle, 309
- Chlamydia* spp., 272–273
preparation of slide for MIF assay, 276f
shell vial for culture, 275f
- Chlamydia pneumoniae*, 208, 272, 273, 277
fast facts, 414t
positive cell culture for, 274f
positive MIF assay for, 276f
- Chlamydia psittaci*, 272–273, 276f
fast facts, 414t
- Chlamydia trachomatis*, 272, 273
detection, 310
DFA smear collection kit for, 274f
fast facts, 414t
Giemsa stain of positive culture, 274f
helicase-dependent amplification, 326f
hybrid capture assay, 318f
positive cell culture for, 274f
positive DFA test for, 275f
positive inclusion indirect immunofluorescence assay for, 276f
rapid immunoassay for direct detection, 275f
real-time polymerase chain reaction (PCR), 319f
strand displacement amplification, 325f
transcription-based amplification, 324f
- Chocolate agar
Abiotrophia, 34f
Brucella abortus, 205f
Campylobacter fetus, 264f
Capnocytophaga spp., 175f
Haemophilus, 345f
Haemophilus aegyptius, 194f
Haemophilus influenzae, 193f
Moraxella lacunata, 164f
Mycoplasma hominis, 279f
Neisseria, 345f
Neisseria flavescens, 186f
Neisseria gonorrhoeae, 186f

- Chocolate agar (*cont'd*)
Neisseria lactamica, 187f
Neisseria meningitidis, 186f, 187f
 plating media, 345f
Streptococcus pneumoniae, 18f
- Cholera, 134–135
- CHROMagar
Escherichia coli, 107f
 plating media, 347f
Salmonella, 110f
- Chromobacterium* spp., 169–170
 differentiating characteristics, 172t
- Chromobacterium violaceum*
 blood agar, 177f
 fast facts, 397t
 indole and nitrate reactions, 177f
 Mueller-Hinton agar, 177f
- Chromogenic media, *Listeria monocytogenes*, 50f
- Chronobacter*, 91, 93t, 94t
- Chryseobacterium* spp., 160–161, 162t
- Chryseobacterium indologenes*, 160
 colonies, blood agar, 167f
 colonies, on Mueller-Hinton agar, 167f
 fast facts, 395t
- Church, George, 309
- CIN agar (cefsulodin-irgasan-novobiocin), 130, 141
Aeromonas caviae, 144f
Yersinia enterocolitica, 98f, 133f
- Citrate reaction
 biochemical test, 351f
Citrobacter, 116t, 123f
Edwardsiella tarda, 116t
Enterobacter, 119f, 123f
Klebsiella, 119f, 123f
Salmonella, 106t
Serratia, 119f, 123f
- Citrobacter* spp., 91, 93t, 94t, 106f, 114, 142
 Enterotube II identification system, 123f
 IMViC reactions, 120f
 key characteristics, 116t
 TSI agar slant, 119f
- Citrobacter amalonaticus*, API 20E system, 121f
- Citrobacter freundii*, 114
 API 20E system, 121f
 fast facts, 387t
 MacConkey agar, 118f
- Citrobacter koseri*, 114
 fast facts, 388t
- Clinical and Laboratory Standards Institute, 299
- Clostridioides* (formerly *Clostridium*)
difficile, 114, 223, 225
 BBL selective agar, 229f
 CDC agar, 228f
 CDC agar, examined under UV light, 229f
 characteristics, 224t
 cytotoxin neutralization assay for, 229f
 detecting repeated DNA sequences, 308
 detection of, GDH and toxins A and B by EIA, 230f
 disk pattern, 221f
 fast facts, 407t
 Gram stain, 228f
 helicase-dependent amplification, 326f
 real-time polymerase chain reaction (PCR), 319f
- Clostridium baratii*, 224t
- Clostridium bifermentans*
 characteristics, 224t
 culture, on CDC agar, 226f
 Gram stain, 226f
- Clostridium botulinum*, 225
 CDC agar, 227f
 characteristics, 224t
 fast facts, 405t
 Gram stain, 227f
- Clostridium butyricum*, 223
 characteristics, 224t
- Clostridium cadaveris*, 223
 characteristics, 224t
- Clostridium clostridioforme*, 223
 CDC agar, 227f
 characteristics, 224t
 Gram stain, 227f
- Clostridium glycolicum*,
 characteristics, 224t
- Clostridium innocuum*, 223
 characteristics, 224t
 fast facts, 405t
- Clostridium paraputrificum*, Gram stain,
 from blood culture, 230f
- Clostridium perfringens*, 223, 225
 API 20A system, 222f
 brucella agar, 231f
 characteristics, 214t, 224t
 egg yolk agar, 232f
 fast facts, 405t
 Gram stain, 220f
 Gram stain, from culture and patient with necrotizing fasciitis, 231f
 phenylethyl alcohol agar, 231f
 presumptive identification, 219f
 RapID ANA II system
 anaerobic identification, 222f
 reverse CAMP test for identification, 232f
- Clostridium ramosum*, 223
 antimicrobial susceptibility testing, 233f
 CDC agar, 232f
 characteristics, 224t
 fast facts, 405t
 Gram stain, 232f
Clostridium septicum, 225
 CDC agar, 233f
 characteristics, 224t
 fast facts, 406t
 Gram stain, 233f
 Gram stain, from blood culture, 233f
- Clostridium sordellii*, 223
 CDC agar, 234f
 characteristics, 224t
 fast facts, 406t
 Gram stain, 233f
 urea and indole reactions, 234f
- Clostridium sporogenes*
 CDC agar, 235f
 characteristics, 224t
 Gram stain, 235f
- Clostridium tertium*, 225
 CDC agar, 236f
 characteristics, 224t
 fast facts, 406t
 Gram stain, 235f
- Clostridium tetani*, 225
 characteristics, 214t, 224t
 culture, on CDC agar, 236f
 fast facts, 407t
 Gram stain, 236f
- Clue cell, Gram stain, 47f
- Cluster DNA sequencing, using reversible dye terminators, 328f
- CNA (colistin-nalidixic acid) blood agar
Corynebacterium diphtheriae, 42f
Enterococcus, 348f
- CO₂ growth enhancement, *Brucella abortus*, 205f
- Coagulase-negative staphylococci (CoNS), 1–2, 8
 differentiating *Staphylococcus aureus* from, 10f
- Coagulase test, 2, 6f
 slide, 6f, 351f
Staphylococcus, 6f, 351f
 tube test, 351f
- Cohen, Stanley N., 308
- Colistin disk differentiation test,
Neisseria, 189f
- Colistin-nalidixic acid (CNA). *See*
 CNA (colistin-nalidixic acid)
 blood agar
- Columbia CNA-MacConkey agar
 biplate, plating media, 348f
- Comamonas* spp., 150, 152t
 blood agar, 155f
 Gram stain, 155f
- Congenital syphilis, 284
- Corynebacterium* spp., 36–37, 48
 Gram stain, 42f

- Corynebacterium amycolatum*, 36, 40t
clinical infections and characteristics, 37t
identification, 40t
- Corynebacterium aurimucosum*, 36
clinical infections and characteristics, 37t
identification, 40t
- Corynebacterium coyleae*, 36
clinical infections and characteristics, 37t
identification, 40t
- Corynebacterium diphtheriae*, 36, 40t, 41
API Coryne system, 44f
blood agar, 42f
clinical infections and characteristics, 37t
fast facts, 376t
fosfomycin blood agar, 42f
Gram stain, 42f
identification, 40t
Loeffler's serum agar slant, 43f
methylene blue stain, 43f
tellurite agar, 43f
- Corynebacterium glucuronolyticum*, 36
clinical infections and characteristics, 38t
identification, 40t
- Corynebacterium jeikeium*, 36
blood agar, 44f
clinical infections and characteristics, 38t
fast facts, 376t
identification, 40t
by RapID CB Plus system, 44f
- Corynebacterium kroppenstedtii*, 36
clinical infections and characteristics, 38t
identification, 40t
- Corynebacterium macginleyi*, 36
clinical infections and characteristics, 38t
identification, 40t
- Corynebacterium propinquum*, 36
clinical infections and characteristics, 38t
identification, 40t
- Corynebacterium pseudodiphtheriticum*, 36
API Coryne system, 45f
blood agar, 45f
clinical infections and characteristics, 38t
identification, 40t
- Corynebacterium pseudotuberculosis*, 36
clinical infections and characteristics, 38t
identification, 40t
- Corynebacterium resistens*, 36
clinical infections and characteristics, 38t
identification, 40t
- Corynebacterium riegliei*, 36
clinical infections and characteristics, 38t
identification, 40t
- Corynebacterium simulans*, 36
clinical infections and characteristics, 38t
identification, 40t
- Corynebacterium striatum*, 36
clinical infections and characteristics, 38t
fast facts, 376t
identification, 40t
- Corynebacterium tuberculostearicum*,
identification, 40t
- Corynebacterium ulcerans*, 36
clinical infections and characteristics, 38t
identification, 40t
- Corynebacterium urealyticum*, 36
blood agar, 45f
clinical infections and characteristics, 39t
fast facts, 376t
identification, 40t
urea agar slant, 46f
- Corynebacterium xerosis*, blood agar, 46f
- Coryneform bacteria, 36
clinical infections and characteristics, 37t–40t
identification, bacteria causing infection in humans, 40t–41t
- Coxiella* spp., 293–294
- Coxiella burnetii*, 208, 293
electron micrograph, 295f
fast facts, 419t
heart section from patient with endocarditis, 295f
shell vial culture, 295f
- Crick, Francis, 307
- CRISPR (clustered regularly interspaced palindromic repeats), 308–309
- Cronobacter* spp., 114
- Cronobacter sakazakii*
API 20E system, 121f
colonies, blood agar, 122f
colonies, on nutrient agar, 120f
fast facts, 388t
- Cryptosporidium*, 71
- Crystal violet stain, 343f
- Cupriavidus* spp., 150, 152t
- Cutaneous anthrax, 54
- Cutibacterium* spp., 239–241
characteristics, 242t
- Cutibacterium acnes*, 240
aerotolerance, 248f
catalase test for presumptive identification, 249f
characteristics, 242t
fast facts, 409t
Gram stain, 248f
indole test for presumptive identification, 249f
- Cutibacterium avidum*, 240, 242t
- Cutibacterium granulosum*, 240, 242t
- Cycloserine-cefoxitin-fructose agar (CCFA), 215t
- Cyclospora*, 71
- Cystic fibrosis (CF), 252
- Cysteine-containing medium, *Legionella*, 182f
- Cystine Trypticase agar, sugars, 185
biochemical test, 352f
Neisseria spp., 189f
- Cytosine, 307, 311f, 312f
- Cytotoxin neutralization assay, *Clostridioides difficile*, 229f
- ## D
- Dark-field micrograph
Leptospira interrogans, 286f
Treponema pallidum subsp. *pallidum*, 287f
- Decarboxylase-dihydrolase test
biochemical test, 352f
Enterobacteriales, 93t, 94t
- Delftia acidovorans*, 150, 151, 152t
by RapID NF Plus system, 156f
- Dempster, Arthur J., 309
- Deoxyribose, 307, 311f. *See also* DNA (deoxyribonucleic acid)
- Dermabacter hominis*, 37, 41t
clinical infections and characteristics, 39t
- Dermacentor andersoni* (tick), 290
- Dermacentor variabilis* (tick), 290
- Dermatophilus*, 64
- DETECTR (DNA endonuclease-targeted CRISPR *trans* reporter) method, 309
- Dietzia*, 64
- Digital imaging, clinical microbiology laboratory, 334f–335f
- Direct fluorescent-antibody (DFA) test, 55, 197, 211
Bacillus anthracis, 58f
Bordetella pertussis, 199f
Chlamydia trachomatis, 273, 274f, 275f
Francisella tularensis, 211f
Legionella pneumophila, 182f
Yersinia pestis, 133f

- Disk diffusion method, *Acinetobacter* spp., 163f
- Disk pattern
Bacteroides fragilis group, 220f
Clostridium spp., 221f
Fusobacterium spp., 221f
Porphyromonas spp., 221f
Veillonella spp., 221f
- DNA (deoxyribonucleic acid)
branched DNA, 323f
building blocks, 307, 311f
Cervista molecular assay, 322f
cluster DNA sequencing using reversible dye terminators, 328f
DNA-DNA hybridization, 307, 313f
double-stranded DNA (dsDNA), 308, 312f
helicase-dependent amplification, 326f
hybrid capture assay, 318f
hydrogen bonds between bases, 312f
line probe assays, 317f
MALDI-TOF MS, 329f
molecular probes, 320f
multiplex PCR (polymerase chain reaction), 321f
nested PCR, 320f
nucleotides, 311f
PCR, 319f
pulsed-field gel electrophoresis (PFGE), 315f
pyrosequencing, 327f
real-time PCR, 319f
restriction fragment length polymorphism (RFLP) analysis, 314f
reverse transcriptase PCR, 321f
sequencing (Sanger method), 326f
single-stranded DNA (ssDNA), 308
Southern blotting, 316f
strand displacement amplification, 325f
structure, 307
transcription-based amplification, 324f
- DNase test
biochemical test, 352f
differentiating *Staphylococcus aureus* from CoNS, 8f
Neisseria spp., 185t, 189f
Moraxella catarrhalis, 189f
Shewanella putrefaciens, 166f
Stenotrophomonas maltophilia, 154f
- Dole, Malcolm, 309
Dolosicoccus, 30, 31t
Dolosigranulum, 30, 31t
Doty, Paul, 307
Doudna, Jennifer, 309
D test, inducible clindamycin resistance, 300, 303f
- Dual hybridization probes, 320f
- Dulcitol reaction
Klebsiella, *Enterobacter*, *Serratia*, and *Citrobacter*, 123f
Salmonella spp., 106t
- Dysgonomonas* spp., 170
differentiating characteristics, 172t
- E**
- Edwardsiella* spp., 91, 93t, 94t, 116t
Edwardsiella tarda
key characteristics, 116t
TSI agar slant, 127f
- Eggerthella* spp., characteristics, 242t
Eggerthella lenta, 241
CDC agar, 250f
fast facts, 409t
Gram stain, 249f
- Egg yolk agar (EYA), 215t, 219f
Bacillus cereus, 60f
Bacillus subtilis, 60f
Clostridium perfringens, 232f
Fusobacterium necrophorum, 259f
- Ehrlichia* spp., 291–293
Ehrlichia chaffeensis
Amblyomma americanum (tick) and, 296f
buffy coat preparation demonstrating morulae, 294f
electron micrograph of monocyte infected, 295f
fast facts, 418t
infections in humans, 292t
- Ehrlichia ewingii*
fast facts, 419t
infections in humans, 292t
Wright-stained peripheral blood smears, 294f
- Ehrlich's reagent, 353f
- Eikenella* spp., 170
differentiating characteristics, 172t
- Eikenella corrodens*
blood agar, 175f
fast facts, 397t
Gram stain, 175f
- Electron micrograph
Coxiella burnetii, 295f
Ehrlichia chaffeensis, 295f
- Elizabethkingia* spp., 157, 160, 161, 162t
Elizabethkingia anopheles, 161
fast facts, 395t
- Elizabethkingia meningoseptica*, 161
fast facts, 395t
- Ellinghausen medium, *Leptospira*, 282
- Endocarditis, 168–171
Coxiella burnetii, 295f
- Enteroaggregative *E. coli* (EAEC), 103
- Enterobacter* spp., 91, 93t, 94t, 114, 117t
arginine, lysine, and ornithine decarboxylase reactions, 119f
Enterotube II identification system, 123f
IMViC reactions, 119f
key characteristics, 115t
MacConkey agar, 118f
TSI agar slant, 119f
- Enterobacter (Klebsiella) aerogenes*, API 20E system, 120f, 121f
- Enterobacterales* (order), 91–92, 113–117
Andrade's broth, 349f
API 20E system, 100f
BBL Crystal Enteric/Nonfermenter ID system, 99f
citrate utilization, 351f
decarboxylase-dihydrolase reactions of members, 93t, 94t
Enterotube II identification system for, 101f
Gram stain, 95f
IMViC lactose reactions of common, 93t
Microbact Gram-negative identification system, 101f
Micro-ID system, 99f
MicroScan Combo plate system, 100f
positive reactions, 95t
RapID one system, 100f
triple sugar iron (TSI) agar, 102f, 356f
TSI reactions of various, 94t
- Enterobacter cancerogenus*, API 20E system, 120f
- Enterobacter cloacae*
API 20E system, 120f, 121f
colonies, blood agar, 122f
fast facts, 387t
Microbact Gram-negative ID system, 101f
- Enterobacteriaceae*, 237, 300
growth on primary media, 218f
- Enterococcus* spp., 14, 15, 24–25, 48, 237
acidification of methyl- α -D-glucopyranoside for, 28f
algorithm for identification of common isolates, 29f
bile esculin agar, 350f
biochemical used to identify, 27f
CHROMagar, 347f
CNA agar, 348f
identification by API 20 Strep test, 28f
motility as test for identification, 28f
PNA FISH for direct identification, 29f
L-pyrrolidonyl- β -naphthylamide test, 355f

- screen plate for vancomycin-resistant, 302f
- synergy testing using aminoglycosides, 306f
- vancomycin-resistant, 300
- Enterococcus avium*, 24
- Enterococcus casseliflavus*, 24, 25
- blood agar, 26f
- fast facts, 373t
- Enterococcus faecalis*, 24
- bile esculin agar, 350f
- bile-esculin agar slants, 33f
- fast facts, 372t
- sheep blood agar, 25f
- Enterococcus faecium*, 24
- acidification of methyl- α -D-glucopyranoside, 28
- blood agar, 18f
- differentiation of *Streptococcus bovis* from, 22
- fast facts, 372t
- Gram stain, 25f
- sheep blood agar, 25f
- Enterococcus gallinarum*, 24, 25
- fast facts, 373t
- Enterococcus raffinosus*, 24, 25
- Enteropathogenic *E. coli* (EPEC), 103
- Enterotoxigenic *E. coli* (ETEC), 103
- Enterotube II identification system, 101f
- Citrobacter*, 123f
- Enterobacter*, 123f
- Klebsiella*, 123f
- Serratia*, 123f
- Enzyme immunoassays (EIAs), 225
- Chlamydia trachomatis*, 273
- Clostridioides difficile*, 230f
- Helicobacter pylori*, 271f
- Enzyme-linked immunosorbent assay (ELISA), *Treponema pallidum*, 285, 289f
- Eosin methylene blue agar, plating media, 347f
- Epsilonometer test, 299
- Erysipelothrix* spp., 49
- production of H₂S by, 53f
- Erysipelothrix inopinata*, 49
- Erysipelothrix larvae*, 49
- Erysipelothrix rhusiopathiae*, 49
- blood agar, 52f
- fast facts, 378t
- gelatin stab culture, 53f
- Gram stain, 52f
- Erysipelothrix tonsillarum*, 49
- Escherichia coli*, 91, 92, 93t, 94t, 103–104
- API 20E system, 100f
- BBL Crystal Enteric/Nonfermenter ID system, 99f
- characteristic reactions, 104t
- CHROMagar, 347f
- colonies, 104
- colonies, on CHROMagar agar, 107f
- colonies, on HE agar, 107f
- colonies, on MacConkey agar, 106f, 108f
- detecting repeated DNA sequences, 308
- disk diffusion (Kirby-Bauer) antimicrobial susceptibility test, 301
- Enterotube II identification system, 101f
- eosin methylene blue agar, 347f
- fast facts, 386t
- Gram stain, 106f
- HE agar, 97f
- IMViC reactions, 108f
- MacConkey agar, 96f, 98f, 345f, 348f
- malakoplakia, 363f
- Microbact Gram-negative ID system, 101f
- Micro-ID system, 99f
- MicroScan Combo plate system, 100f
- modified carbanem inactivation method (mCIM), 304f
- MUG test, 98f
- RapID onE system, 100f
- restriction endonucleases, 313f
- toxin assay for qualitative detection of Shiga toxins by, 108f
- TSI agar slant, 107f
- Esculin hydrolysis
- Abiotrophia*, 31t
- aerobic Gram-positive cocci, 31t
- Aerococcus*, 31t
- Aeromonas* spp., 142t
- Bacteroides fragilis*, 254t
- BactiCard, 23f
- Dolosigranulum*, 31t
- Globicatella*, 31t
- Gram-negative bacilli, 254t
- Gram-positive bacilli, 242t
- Helcococcus*, 31t
- Lactococcus*, 31t
- Pedicoccus*, 31t
- Vagococcus*, 31t
- Weissella*, 31t
- ESwab collection and transport system, 217f
- Etest, 299, 302f
- Eubacterium* spp., 239–241, 242t
- European Committee on Antimicrobial Susceptibility Testing, 299
- Extended-spectrum β -lactamase (ESBL), phenotypic test for, 300, 303f
- F**
- Facklamia*, 30, 31t
- Federal Select Agent Program, 210
- Fenn, John B., 309
- Fermentative pathway, 350f
- Fiers, Walter, 308
- Finegoldia magna*, 237
- CDC agar, 243f
- characteristics, 238t
- fast facts, 408t
- Gram stain, 243f
- Firmicutes*, 239
- Fite-Faraco method, *Mycobacterium leprae*, 75f
- Fite stain, 338
- lepromatous leprosy by *Mycobacterium leprae*, 363f
- Flavobacterium odoratum*, blood agar, 164f
- Fletcher's medium, *Leptospira*, 282
- Fluorescence resonance energy transfer (FRET), 322f
- Fluorescent *in situ* hybridization (FISH) assay, 25
- method, 318f
- Staphylococcus aureus* and CoNS, 10
- Fluorescent staining, *Leptospira interrogans*, 286f
- Francisella* spp., 210–211
- Francisella tularensis*, 181, 210–211
- DFA staining, 211f
- fast facts, 404t
- Gram stain, 211f
- modified Thayer-Martin agar, 212f
- Franklin, Rosalind, 307
- FTA-ABS DS test, *Treponema pallidum*, 284, 288f
- Fusobacterium* spp., 253
- characteristics, 254t
- disk pattern, 221f
- fluorescence, 258f
- Gram stain with carbol fuchsin, 343f
- presumptive identification, 215t
- Fusobacterium mortiferum*
- BBE agar, 260f
- characteristics, 214t, 254t
- Gram stain, with carbol fuchsin counterstain, 259f
- Fusobacterium necrophorum*
- CDC agar, 259f
- characteristics, 214t
- egg yolk agar, 259f
- fast facts, 410t
- Gram stain, with carbol fuchsin counterstain, 259f
- Fusobacterium nucleatum*
- CDC agar, 258f
- characteristics, 214t, 254t
- fast facts, 410t
- Gram stain, 220f
- Gram stain, with carbol fuchsin counterstain, 258f
- Fusobacterium varium*, 253, 254t

G

- Gardnerella vaginalis*, 37, 41t
 clinical infections and characteristics, 39t
 colonies on blood agar and vaginalis agar, 47f
 fast facts, 377t
 Gram stain, 47f
 hippurate hydrolysis test, 353f
 Gas gangrene, 225–226
 GasPak EZ gas-generating pouch system, 217f, 263f
 Gastritis, *Helicobacter pylori*, 269f, 365f
 “*Gastrospirillum hominis*,” 267
 Gelatin hydrolysis
 Bacillus differentiation, 56t
 biochemical test, 353f
 Enterobacteriales, 95t
 Erysipelothrix rhusiopathiae, 53f
 Pseudomonas spp., 146t
 Pseudomonas fluorescens, 149f
Gemella, 31t
 blood agar, 34f
 Gram stain, 32f
Gemella haemolysans, 30
Geobacillus, 54
Geobacillus stearothermophilus, 54
 Giemsa stain
 Chlamydia trachomatis, 274f
 Helicobacter pylori, 269f, 365f
 Gilbert, Walter, 308
Globicatella, 30, 31t
 Glucose test
 Actinobacillus, 171t
 Burkholderia spp., 152t
 Haemophilus spp., 192t
 Leuconostoc, 34f
 Neisseria, 185t
 Pasteurella, 172t
 Pseudomonas spp., 146t
 Glutamate dehydrogenase (GDH)
 assay, 225
 Glycolytic pathway, 350f
 Golden pigment, *Staphylococcus aureus*, 4f
 GMS. *See* Grocott’s methenamine silver (GMS)
 Gomori methenamine silver stain
 Actinomyces israelii, 246f
 Gonocheck-II system, 190f
Gordonia spp., 62, 63–64
 Gram, Christian, 338
 Gram-negative bacilli
 anaerobic, 253
 curved, pleomorphic, resembling *Campylobacter*, 340f
 differentiating characteristics, 162t
 fastidious or rarely encountered, 168–171
 long, slender, 340f
 long, slender, pleomorphic, resembling anaerobic organisms, 340f
 nonfermentative, 157–162
 short, with bipolar staining, 340f
 Gram-negative bacteria, anaerobic, 252–253
 Gram-negative cocci, anaerobic, 252–253
 Gram-negative coccobacilli, small, 339f
 Gram-negative diplococci, intracellular, 339f
 Gram-positive and Gram-variable bacilli, large, with terminal spores, 341f
 Gram-positive bacilli
 anaerobic, non-spore-forming, 239–242
 beaded bacilli suggestive of mycobacteria, 341f
 branching, 341f
 long, 340f
 short, in palisade formation, 340f
 Gram-positive cocci
 anaerobic, 237–239, 243f
 hematoxylin and eosin stain, 246f
 identification of miscellaneous, 31t
 in pairs and chains, 339f
 in pairs and clusters, 339f
 in pairs and short chains, 339f
 Gram-positive diplococci, Lancet-shaped, 339f
 Gram stain, 2
 Abiotrophia, 32f
 Achromobacter xylosoxidans, 199f
 Acinetobacter spp., 162f
 Actinomyces israelii, 220f, 246f
 Actinomyces odontolyticus, 247f
 Aerococcus viridans, 32f
 Aeromonas hydrophila, 143f
 Aggregatibacter actinomycetemcomitans, 173f
 anaerobe characteristics, 214t
 artifacts in, 343f
 Bacillus anthracis, 56f
 Bacillus anthracis on urea agar slant, 56f
 Bacillus cereus, 57f
 Bacteroides fragilis, 219f
 Bacteroides fragilis with carbol fuchsin, 219f, 254f
 Bartonella henselae, 208f
 Bartonella henselae with carbol fuchsin, 208f
 Bifidobacterium dentium, 249f
 Bordetella parapertussis with carbol fuchsin, 199f
 Bordetella pertussis, 199f
 Bordetella pertussis with carbol fuchsin, 199f
 Borrelia burgdorferi with carbol fuchsin, 286f
 Brucella spp., 204f
 Campylobacter fetus, 263f
 Campylobacter jejuni with carbol fuchsin, 262f
 Campylobacter jejuni with safranin, 262f
 Capnocytophaga spp., 174f
 carbol fuchsin counterstain, 343f, 344f
 carbol fuchsin modification, 343f
 Cardiobacterium hominis, 176f
 Clostridioides difficile, 228f
 Clostridium and *Clostridioides* spp., 224t
 Clostridium bifermentans, 226f
 Clostridium botulinum, 227f
 Clostridium clostridioforme, 227f
 Clostridium paraputrificum, 230f
 Clostridium perfringens, 220f, 231f
 Clostridium ramosum, 232f
 Clostridium septicum, 233f
 Clostridium sordellii, 233f
 Clostridium sporogenes, 235f
 Clostridium tertium, 235f
 Clostridium tetani, 236f
 clue cell, 47f
 Comamonas spp., 155f
 Corynebacterium spp., 42f
 Corynebacterium diphtheriae, 42f
 crystals in, 343f
 Cutibacterium acnes, 248f
 Eggerthella lenta, 249f
 egg yolk agar, 219f
 Eikenella corrodens, 175f
 Enterobacteriales, 95f
 Enterococcus faecium, 25f
 Erysipelothrix rhusiopathiae, 52f
 Escherichia coli, 106f
 femur infected with aerobic/anaerobic Gram-positive cocci, 243f
 Fingoldia magna, 243f
 Francisella tularensis, 211f
 Fusobacterium mortiferum, 259f
 Fusobacterium necrophorum with carbol fuchsin, 259f
 Fusobacterium nucleatum, 220f, 258f
 Gardnerella vaginalis, 47f
 Gemella, 32f
 Haemophilus ducreyi, 193f
 Haemophilus influenzae, 193f
 Helicobacter pylori, 268f, 269f
 high-quality sputum specimen, 341f
 Klebsiella, 118f
 Lactobacillus spp., 250f
 Legionella, 181f
 Legionella with carbol fuchsin, 181f
 Leuconostoc, 32f
 Listeria monocytogenes, 49f

- low-quality sputum specimen, 342f
Methylobacterium spp., 166f
Micrococcus luteus, 4f
 mixed infection with suspected anaerobes, 219f
Mobiluncus spp., 251f
Moraxella spp., 163f
 mucoid *Pseudomonas aeruginosa*, 147f
Mycobacterium tuberculosis, 74f
Neisseria elongata, 186f
Neisseria gonorrhoeae, 186f
Neisseria meningitidis, 186f
Nocardia asteroides, 64f
Parvimonas micra, 243f
Pasteurella multocida, 178f
Peptoniphilus asaccharolyticus, 245f
Peptostreptococcus anaerobius, 244f
Porphyromonas sp. from CDC agar with carbol fuchsin, 257f
 precipitated stain in, 343f
Prevotella melaninogenica with carbol fuchsin, 256f
 procedure, 338
Pseudomonas aeruginosa, 147f
Rhodococcus equi, 67f
 safranin as counterstain, 343f
Staphylococcus aureus, 4f
Streptococcus mutans, 16f
Streptococcus pneumoniae, 13, 16f
Streptococcus pyogenes, 16f
Trueperella pyogenes, 46f
 underdecolorized, 342f
Veillonella sp., 260f
Vibrio spp., 137f
 viridans group streptococci, 16f
Yersinia enterocolitica, 131f
Yersinia pestis, 131f
 Granada agar, *Streptococcus agalactiae*, 19f
Granulibacter, 157–158
Granulicatella, 30, 31t
 fast facts, 374t
Grimontia hollisae, 135, 136t
 Grocott methenamine silver (GMS), 338
 pulmonary actinomycosis, 362f
 pulmonary nocardiosis, 361f
Rhodococcus pulmonary infection, 361f
 Growth enhancement, *Streptococcus constellatus*, 18f
 Growth rate, mycobacteria, 73t
 Guanine, 307, 311f, 312f
 Guillain-Barré syndrome, 261
- H**
- H₂S production
Brucella spp., 204t, 206f
Citrobacter, 116t, 123f
Edwardsiella tarda, 116t
Enterobacter, 123f
Klebsiella, 123f
Salmonella spp., 106t
Serratia, 123f
 HACEK group, 168, 191
Haemobacter, 158t
Haemophilus spp., 49, 191–192
 biochemical reactions for determining biotypes, 192t
 chocolate agar, 345f
 identification by RapID NH system, 196f
 identification using Hemo-ID Quad plate, 195f
 key reactions for differentiating, 192t
 modified Thayer-Martin agar, 346f
 porphyrin production test, 195f
Haemophilus aegyptius, 191, 192t
 chocolate agar, 194f
Haemophilus ducreyi, 191, 192t
 fast facts, 400t
 Gram stain, 193f
 in thioglycolate broth, 195f
Haemophilus haemolyticus, 191, 192t
 comparing hemolysis of *H. influenzae* and, 196f
 fast facts, 400t
Haemophilus influenzae, 191, 192
 biochemical reactions for determining biotypes, 192t
 biotyping, 196f
 chocolate agar, 193f
 comparing hemolysis of *H. haemolyticus* and, 196f
 fast facts, 400t
 Gram stain, 193f
 porphyrin production test, 195f
 requirement for X and V factors, 194f
 satellite colonies, 194f
 serotyping, 196f
 in thioglycolate broth, 195f
Haemophilus parahaemolyticus, 191, 192t
 fast facts, 400t
Haemophilus parainfluenzae, 191, 192t
 fast facts, 400t
 porphyrin production test, 195f
 requirement for V factor, 194f
 restriction endonucleases, 313f
Hafnia spp., 91, 93t, 94t, 113, 116
Hafnia alvei
 API 20E system, 128f
 MacConkey agar, 127f
 TSI agar slant, 127f
Haloferax mediterranei, 308
 HE agar
 colonies of *Escherichia coli*, 107f
Escherichia coli, 97f
 H₂S-positive *Salmonella* colonies, 97f
Salmonella spp., 109f
Shigella spp., 97f, 109f
 Heart patient, endocarditis by *Coxiella burnetii*, 295f
 Hektoen agar
Aeromonas hydrophila, 143f
 plating media, 346f
Plesiomonas shigelloides, 128f
Helcococcus, 30, 31t
 Helicase-dependent amplification, 326f
Helicobacter spp., 267–268
 biochemical reactions, 268t
Helicobacter heilmannii, 267, 365f
 fast facts, 413t
 immunohistochemical stain of gastric biopsy samples, 270f
Helicobacter pylori, 267–268
 CLO (*Campylobacter*-like organism) test for, 268, 271f
 detection of antigen by enzyme immunoassay, 271f
 fast facts, 413t
 gastric biopsy specimen for, 269f
 gastritis, 365f
 Gram stain, 268f
 Gram stain of touch preparation from gastric biopsy specimen positive for, 269f
 helicase-dependent amplification, 326f
 immunohistochemical stain of gastric biopsy samples, 270f
 line probe assays, 317f
 Thayer-Martin medium, 270f
 Hematoxylin and eosin stain, 239, 340f
 cat scratch diseases, 364f
Helicobacter heilmannii, 365f
Helicobacter pylori gastritis, 365f
 intestinal spirochetosis, 364f
 lepromatous leprosy by
Mycobacterium leprae, 363f
 malakoplakia, 363f
 maternal-fetal listeriosis, 360f
 orbital cellulitis, 358f
 pulmonary actinomycosis, 362f
 pulmonary nocardiosis, 361f
Rhodococcus pulmonary infection, 361f
 secondary syphilis, 366f
 septic cerebral embolism 358f
 streptococcal toxic-shock syndrome, 359f
 sulfur granule from tonsils, 246f
 Hemo-ID Quad plate, *Haemophilus* spp., 195f
 Hippurate hydrolysis test
 biochemical test, 353f
Campylobacter jejuni, 265f, 353f
Gardnerella vaginalis, 353f
Streptococcus agalactiae, 21f

- Histopathology, 358f–366f
 catch scratch disease by *Bartonella henselae*, 364f
Helicobacter heilmannii, 365f
Helicobacter pylori gastritis, 365f
 intestinal spirochetosis (*Brachyspira* spp.), 364f
 lepromatous leprosy caused by *Mycobacterium leprae*, 363f
 malakoplakia, 363f
 maternal-fetal listeriosis, 360f
 orbital cellulitis, 358f
 pulmonary actinomycosis, 362f
 pulmonary nocardiosis, 361f
Rhodococcus pulmonary infection, 361f
 secondary syphilis, 366f
 septic cerebral embolism, 358f
 streptococcal toxic shock syndrome with necrotizing fasciitis, 359f
- Hood, Leroy, 308
 Hucker, G. J., 338
 Hugh and Leifson carbohydrate oxidative-fermentative medium, biochemical test, 350f
 Human granulocytic anaplasmosis (HGA), 292, 293
 Hungate, R. E., 213
 Hybrid capture assay, 318f
- I**
Ignavigranum, 30, 31t
 ImmunoCard STAT! Campy, 265f
 ImmunoCard STAT! HpSA test, 271f
 Immunohistochemical stain
Helicobacter heilmannii, 270f
Helicobacter pylori, 270f
 IMViC reactions
Citrobacter, 120f
Enterobacter, 119f
Escherichia coli, 108f
Klebsiella, 119f
Salmonella serotype Typhi, 111f
Serratia, 119f
 India ink stain, *Bacillus anthracis*, 57f
 Indole test
Bacteroides fragilis, 254t
 biochemical test, 353f
Cardiobacterium hominis, 172t, 176f
Chromobacterium violaceum, 172t, 177f
Citrobacter, 116t, 120f, 123f
Clostridium sordellii, 234f
Cutibacterium acnes, 249f
Dysgonomonas spp., 172t
Edwardsiella tarda, 116t
Enterobacter, 123f
Escherichia coli, 104t
 Gram-negative bacilli, 162t, 254t
 Gram-positive bacilli, 242t
Haemophilus influenzae, 192t, 196f
Klebsiella, 115t, 123f
Pasteurella spp., 172t
Peptoniphilus asaccharolyticus, 245f
Plesiomonas, 117t
 Proteaceae, 117t
Raoultella, 115t
Salmonella, 106t
Serratia, 116t, 123f
Shigella, 104t
Yersinia spp., 130t
 Inducible clindamycin resistance, D test, 300, 303f
 Infections. *See* Bacterial infections
 Infectious Diseases Society of America, 225
 Ingestion anthrax, 55
 Inhalation anthrax, 54–55
 INNO-LIA Syphilis Score, 289f
 Inositol reaction
Enterobacter, 120f
Plesiomonas, 117t
 Proteaceae, 117t
 Intercalating dyes, 320f
 Intestinal spirochetosis, *Brachyspira* spp., 364f
 Iron uptake test, *Mycobacterium*, 73t, 88f
Isospora, 71
Ixodes, 282
Ixodes pacificus (tick), 287f
Ixodes persulcatus (taiga tick), 292
Ixodes ricinus (castor bean tick), 292
Ixodes scapularis (black-legged tick), 292
- J**
 JEMBEC plates, 188f
- K**
 Kanamycin-vancomycin-laked blood agar (KVLB), 215t, 253
Bacteroides fragilis, 255f, 349f
 plating media, 349f
Prevotella corporis, 256f
Prevotella melaninogenica, 349f
Kerstersia spp., 198
 Kiestra Total Laboratory Automation (TLA) system, 331, 333f
Kingella spp., 170
 differentiating characteristics, 172t
Kingella kingae, 170
 blood agar, 176f
 fast facts, 397t
 Kinyoun stain, 338, 344f
Mycobacterium avium-Mycobacterium intracellulare, 75f
Mycobacterium tuberculosis, 73f
 procedure, 72, 73
- Kirby-Bauer antimicrobial susceptibility test
Escherichia coli, 301f
 method, 299, 301f
Klebsiella spp., 91–92, 95t, 113–114
 Enterotube II identification system, 123f
 Gram stain of sputum specimen with, 118f
 IMViC reactions, 119f
 key characteristics, 115t
 MacConkey agar, 96f, 118f
 TSI agar slant, 119f
Klebsiella granulomatis, 113
 fast facts, 387t
Klebsiella oxytoca, 113
 fast facts, 387t
Klebsiella pneumoniae, 113
 BBL Crystal Enteric/Nonfermenter ID system, 99f
 blood agar, 95f
 decarboxylase-dihydrolase reactions, 93t, 94t
 fast facts, 387t
 IMViC lactose reaction, 93t
 Microbact Gram-negative ID system, 101f
 Micro-ID system, 99f
 modified carbapenem inactivation method (mCIM), 304f
 phenotypic test, 303f
 TSI reactions, 94t
Klebsiella pneumoniae subsp. *ozaenae*, 113
 colonies, blood agar, 122f
 colonies, on MacConkey agar, 123f
Kocuria, 1, 3
 Kornberg, Arthur, 307
Kosakonia, 117
 Kossel, Albrecht, 307
 Kovac's reagent, 353f, 355f
Kurthia, 49
Kytococcus, 1, 3
- L**
 Laboratory automation. *See* Total laboratory automation (TLA)
 Laboratory Response Network (LRN), 54–56, 130
Lactobacillus spp., 49, 239–241
 CDC agar, 250f
 characteristics, 242t
 fast facts, 409t
 Gram stain, 250f
Lactobacillus confusus, 30
Lactococcus, 30, 31t
 Lactose reaction
Burkholderia spp. 152t
Citrobacter, 123f

- Enterobacter*, 123f
Enterobacteriales, 93t
Escherichia coli, 104t
Haemophilus spp., 192t
Klebsiella, 123f
Neisseria, 185t
Serratia, 123f
Shigella, 104t
 Latex test, *Staphylococcus aureus*, 6f
 Lecithinase, *Bacillus* differentiation, 56t, 60f
 Leucine aminopeptidase (LAP) test
 Abiotrophia, 31t
 Aerococcus spp., 31t
 Aerococcus urinae, 33f
 Aerococcus viridans, 33f
 aerobic Gram-positive cocci, 31t
 BactiCard, 23f
 Dolosigranulum, 31t
 Enterococcus spp., 27f
 Facklamia, 31t
 Gemella, 31t
 Globicatella, 31t
 Ignavigranum, 31t
 Lactococcus, 31t
 Pedicoccus, 31t
 Vagococcus, 31t
 LIM broth, *Streptococcus agalactiae*, 19f
 Loeffler's serum agar slant
 Corynebacterium diphtheriae, 43f
 Lady Windermere syndrome, 71
 Lancefield groups, 11
 latex agglutination test for identifying, 22f
 Streptococcus dysgalactiae subsp. *equisimilis*, 12–13
 Latex agglutination test, identification of
 Lancefield groups, 22f
 Lawrence, Ernest, 309
Lawsonella, 62
 Lead acetate test, biochemical test, 354f
Legionella spp., 180–181
 Gram stain, 181f
 Gram stain, with carbol fuchsin, 181f, 343f
 media containing cysteine, 182f
 rapid test for antigen in urine, 183f
 sputum specimen cultured on BCYE agar, 182f
 under long-wavelength UV light, 183f
Legionella micdadei, 71
 fast facts, 398t
Legionella pneumophila, 181
 BCYE agar, 183f
 direct fluorescent-antibody stain, 182f
 fast facts, 398t
 Legionnaires' disease, 180
Lelliottia, 117
 Lepromatous leprosy by *Mycobacterium leprae*, 363f
Leptospira spp., 281–282
Leptospira interrogans, 281
 dark-field micrograph, 286f
 fast facts, 416t
 fluorescent staining, 286f
 Leptospirosis Reference Center, Academisch Medisch Centrum, 282
Leuconostoc, 30, 31t
 blood agar, 33f
 fast facts, 375t
 gas production from glucose by, 34f
 Gram stain, 32f
 vancomycin-resistant, blood agar, 34f
 Line probe assays, 317f
Listeria spp., 48, 49
 blood agar, 50f
 CAMP test, 51f
 Micro-ID *Listeria* system, 51f
Listeria grayi, 48
Listeria innocua, 48, 49, 51f
Listeria ivanovii, 48, 50f, 51f
Listeria marthii, 48
Listeria monocytogenes, 48–49
 blood agar, 50f
 chromogenic media, 50f
 fast facts, 378t
 Gram stain, 49f
 motility on semisolid media, 50f
Listeria seeligeri, 48, 50f, 51f
Listeria sensu lato, 48
Listeria sensu stricto, 48
Listeria welshimeri, 48
 Listeriosis, maternal-fetal, 360f
 Lowenstein-Jensen agar slant, 72
 Mycobacterium abscessus, 78f
 Mycobacterium avium-Mycobacterium intracellulare, 77f
 Mycobacterium chelonae, 79f
 Mycobacterium fortuitum, 80f
 Mycobacterium gordonae, 81f
 Mycobacterium kansasii, 82f
 Mycobacterium marinum, 83f
 Mycobacterium mucogenicum, 84f
 Mycobacterium scrofulaceum, 84f
 Mycobacterium simiae, 85f
 Mycobacterium szulgai, 85f
 Mycobacterium tuberculosis, 76f
 Mycobacterium xenopi, 86f
Lutzomyia verrucarum (sand fly vector), 207
 Lyme borreliosis, 282
 Lysine decarboxylase (LDC)
 Aeromonas spp., 142t
 Citrobacter, 116t, 123f
 Edwardsiella tarda, 116t
 Enterobacter, 115t, 119f, 120f, 121f, 123f
 Enterobacteriales members, 93t, 94t
 Klebsiella, 123f
 Pantoea, 115t
 Photobacterium damsela, 136t
 Serratia, 116t, 123f
 Vibrionaceae, 136t
 Lysostaphin susceptibility, 3, 9f
 Lysozyme test
 Nocardia brasiliensis, 66f
 Streptomyces spp., 69f
- ## M
- MacLeod, Colin, 307
 MacConkey agar
 Achromobacter xylosoxidans, 202f
 Aeromonas hydrophila, 143f
 Alcaligenes faecalis, 202f
 anginosus (milleri) group, 22f
 Bordetella spp., 198t
 Bordetella bronchiseptica, 201f
 Burkholderia cepacia, 153f
 Citrobacter freundii, 118f
 colonies of *Escherichia coli*, 106f
 colonies of *Shigella* spp., 108f
 Columbia CNA-MacConkey agar
 biplate, 348f
 Enterobacter, 118f
 Escherichia coli, 96f, 108f, 345f, 348f
 Hafnia alvei, 127f
 Klebsiella spp., 96f, 118f
 Klebsiella pneumoniae subsp. *ozaenae*, 123f
 Pasteurella multocida, 178f
 plating media, 345f
 Plesiomonas shigelloides, 128f
 Pseudomonas aeruginosa, 147f
 Rhizobium radiobacter, 165f
 Serratia marcescens, 118f
 Serratia rubidaea, 122f
 Yersinia enterocolitica, 131f
 MacConkey agar with sorbitol
 Escherichia coli, 98f
 Escherichia coli O157:H7, 98f
 MacConkey without crystal violet (CV)
 mycobacteria, 73t
 mycobacterial growth on, 87f
 Malachite green stain, *Bacillus anthracis*, 57f
 Malakoplakia, 363f
 Malonate test
 Citrobacter, 116t
 Edwardsiella tarda, 116t
 Enterobacter, 115t
 Enterobacteriales, 95t
 Klebsiella, 115t
 Pantoea, 115t
 Raoultella, 115t
 Serratia, 116t

- Maltose reaction
Brevundimonas vesicularis, 152t
Burkholderia pseudomallei, 152t
Neisseria, 185t
Plesiomonas, 117t
Proteaeae, 117t
Pseudomonas spp., 146t
Ralstonia mannitolilytica, 152t
Stenotrophomonas maltophilia, 152t
- Mannitol salt agar, 2, 6f
- Mannitol salt agar, containing oxacillin, 7f
- Mannitol reaction
Actinobacillus spp., 174f
Burkholderia cepacia, 152t, 155f
Ralstonia spp., 152t, 155f
- Mannose reaction, *Haemophilus* spp., 192t
- Marmur, Julius, 307
- Maternal-fetal listeriosis, 360f
- Matrix-assisted laser desorption ionization-time of flight mass spectrometry (MALDI-TOF MS), 253, 330
- Aeromonas*, 142
anaerobe identification, 239
analytical method, 329f, 330
automated identification method, 309–310
Bordetella spp., 198
Brachyspira spp., 285
campylobacters, 262
Cardiobacterium, 169
Clostridium species, 226
Enterococcus, 25
Leptospira, 282
Myroides spp., 159
Staphylococcus, 3
Streptococcus pneumoniae, 13
Streptococcus pyogenes, 12
- Maxam, Allan, 308
- McCarty, Maclyn, 307
- Melibiose reaction, *Yersinia* spp., 130t
- Meningitidis, 184–185
- Methicillin-resistant *Staphylococcus aureus* (MRSA), 2
assays to detect PBP2a in, 7f
spectra MRSA, 7f
- Methyl- α -D-glucopyranoside, acidification, 28
- Methylene blue
with Loeffler's serum agar, *Corynebacterium*, 42f
metachromatic granules of *Corynebacterium diphtheriae*, 43f
Yersinia pestis, 130
- Methylobacterium* spp., 161, 162t
blood agar, 166f
buffered charcoal-yeast extract agar, 166f
- Gram stain, 166f
modified Thayer-Martin agar, 166f
in motility medium, 167f
Sabouraud agar, 166f
urea agar slant, 167f
- Methyl red test
biochemical test, 354f
Escherichia coli, 104t
Yersinia enterocolitica, 132f
Salmonella spp., 106t
Shigella, 104t
- Metronidazole disk test, 238
anaerobic Gram-positive cocci, 251f
- M'Fadyean stain (polychrome methylene blue), 55
Bacillus anthracis, 57f
Bacillus cereus, 57f
Microbacterium spp., 37, 41t
clinical infections and characteristics, 39t
- Microbact Gram-negative identification system, 101f
- Micrococcus*, 1
Micrococcus luteus, 3
bacitracin susceptibility, 9f
blood agar, 5f
fast facts, 369t
Gram stain, 4f
lysostaphin test, 9f
modified oxidase test, 10f
- Microdase test, 10f
- Micro-ID system, 51f, 99f
- Microimmunofluorescence assay (MIF), 273
Chlamydia pneumoniae, 276f
preparation of slide for, 276f
Rickettsia, 294f
- Microimmunofluorescence antibody test, *Rickettsia*, 294f
- MIC testing
Etest, 302f
microdilution, 301f
- MicroScan Combo plate system, 100f
- Middlebrook 7H10 media, 72
Nocardia asteroides, 65f
- Middlebrook 7H11 agar, 72
Mycobacterium abscessus, 78f
Mycobacterium avium-Mycobacterium intracellulare, 77f
Mycobacterium chelonae, 79f
Mycobacterium fortuitum, 80f
Mycobacterium gordonae, 81f
Mycobacterium haemophilum, 82f
Mycobacterium kansasii, 82f
Mycobacterium marinum, 83f
Mycobacterium mucogenicum, 84f
Mycobacterium scrofulaceum, 84f
Mycobacterium simiae, 85f
Mycobacterium szulgai, 85f
- Mycobacterium tuberculosis*, 76f
Mycobacterium xenopi, 86f
Nocardia asteroides, 65f
- Miescher, Friedrich, 307
- Mobiluncus* spp., 239–241, 242
characteristics, 242t
Gram stain, 251f
- Modified Brown and Hopps stain, 338
maternal-fetal listeriosis, 360f
orbital cellulitis, 358f
pulmonary actinomycosis, 362f
septic cerebral embolism 358f
streptococcal toxic shock syndrome, 359f
- Modified carbapenem inactivation method (mCIM), 304f
- Modified oxidase test, *Staphylococcus* spp., 10f
- Modified Thayer-Martin agar, plating media, 346f
- Mojica, Francisco, 308
- Molecular beacons, 320f
- Molecular diagnosis of bacterial infections, 307–310
branched DNA, 323f
building blocks of DNA and RNA, 311f
Cervista molecular assay, 322f
cluster DNA sequencing with reversible dye terminators, 328f
DNA-DNA and DNA-RNA hybridization, 313f
DNA sequencing (Sanger method), 326f
double-stranded DNA, 312f
fluorescent *in situ* hybridization (FISH), 318f
helicase-dependent amplification, 326f
hybrid capture assay, 318f
hydrogen bonds of base pairs in DNA, 312f
line probe assays, 317f
MALDI-TOF MS, 329
molecular probes, 320f
multiplex PCR, 321f
nested PCR, 320f
nucleotides of DNA and RNA, 311f
polymerase chain reaction (PCR), 319f
pulsed-field gel electrophoresis (PFGE), 315f
pyrosequencing, 327f
real-time PCR, 319f
restriction endonucleases, 308, 313f
restriction fragment length polymorphism (RFLP) analysis, 314f
reverse transcriptase PCR, 321f
Southern blotting, 316f
strand displacement amplification, 325f
transcription-based amplification, 324f

- Molecular probes, 320f
- Moraxella* spp., 158t, 162t
Gram stain, 163f
- Moraxella catarrhalis*, 158
biochemical reactions for *Neisseria* spp. and, 185t
DNase plate for differentiation from *Neisseria* spp., 189f
DNase test, 352f
fast facts, 395t
- Moraxella lacunata*, 158
chocolate agar, 164f
fast facts, 395t
- Morganella*, 91, 93t, 94t, 113, 115
phenylalanine deaminase test, 355f
- Morganella morgani*, 115
API 20E system, 125f, 126f
fast facts, 389t
- Motility test
biochemical test, 354f
Bacillus differentiation, 55t, 56t
Bacillus anthracis versus other *Bacillus* spp., 59f
Enterococcus, 28
Escherichia coli, 104t
Gram-negative bacilli, 162t
Gram-positive bacilli, 242t
Listeria monocytogenes on semisolid medium, 50f
Methylobacterium spp., 167f
Photobacterium damsela, 136t
Vibrionaceae, 136t
Yersinia spp., 130t
- Mucosa-associated lymphoid tissue (MALT), 267
- MUG test, 98f
- Mueller-Hinton agar
Chromobacterium violaceum, 177f
Chryseobacterium indologenes, 167f
disk diffusion antimicrobial susceptibility test, 301f
Etest on, 302f
modified carbapenem inactivation method (mCIM), 304f
Pseudomonas aeruginosa, 148f
- Mullis, Kary, 308
- Mycobacterium* spp., 70–73
arylsulfatase test, 87f
BD BACTEC MGIT, 90f
catalase test, 87f
of clinical significance, 71t
Gram-positive, beaded bacilli suggestive, 341f
growth on MacConkey agar without crystal violet, 87f
identification, 309–310
iron uptake test, 88f
NaCl tolerance test, 89f
niacin accumulation test, 88f
nitrate reduction test, 88f
pyrazinamidase test, 89f
tellurite reduction test, 89f
Tween 80 hydrolysis test, 90f
urease test, 90f
useful tests for identification, 73t
- Mycobacterium abscessus*, 71, 72
fast facts, 385t
Lowenstein-Jensen agar slant, 78f
Middlebrook 7H11 agar, 78f
- Mycobacterium africanum*, 70, 71, 73
- Mycobacterium avium*, 70, 71
auramine stain, 75f
Kinyoun stain, 75f
- Mycobacterium avium-Mycobacterium intracellulare*
fast facts, 382t
Lowenstein-Jensen agar slant, 77f
Middlebrook 7H11 agar, 77f
- Mycobacterium bovis*, 70, 71, 72
fast facts, 381t
- Mycobacterium canettii*, 70, 71, 73
- Mycobacterium caprae*, 70, 71
- Mycobacterium chelonae*, 71, 72
fast facts, 385t
Lowenstein-Jensen agar slant, 79f
Middlebrook 7H11 agar, 79f
- Mycobacterium chimaera*
fast facts, 382t
- Mycobacterium fortuitum*, 71, 72
fast facts, 384t
Lowenstein-Jensen agar slant, 80f
Middlebrook 7H11 agar, 80f
- Mycobacterium genovense*
fast facts, 382t
- Mycobacterium gordonae*, 71, 72
fast facts, 384t
Lowenstein-Jensen agar slant, 81f
Middlebrook 7H11 agar, 81f
- Mycobacterium haemophilum*, 70, 71
fast facts, 382t
Middlebrook 7H11 agar, 82f
- Mycobacterium kansasii*, 71, 72, 73
fast facts, 383t
Lowenstein-Jensen agar slant, 82f
Middlebrook 7H11 agar, 82f
- Mycobacterium leprae*, 71
fast facts, 385t
lepomatous leprosy by, 363f
stained by Fite-Faraco method, 75f
- Mycobacterium marinum*, 70, 71, 73
fast facts, 383t
Lowenstein-Jensen agar slant, 83f
Middlebrook 7H11 agar, 83f
- Mycobacterium microti*, 70, 71, 73
- Mycobacterium mucogenicum*, 71
fast facts, 385t
Lowenstein-Jensen agar slant, 84f
Middlebrook 7H11 agar, 84f
- Mycobacterium pinnipedii*, 70, 71
- Mycobacterium scrofulaceum*, 71
fast facts, 384t
Lowenstein-Jensen agar slant, 84f
Middlebrook 7H11 agar, 84f
- Mycobacterium simiae*, 71
fast facts, 383t
Lowenstein-Jensen agar slant, 85f
Middlebrook 7H11 agar, 85f
- Mycobacterium szulgai*, 71, 73
fast facts, 383t
Lowenstein-Jensen agar slant, 85f
Middlebrook 7H11 agar, 85f
- Mycobacterium tuberculosis*, 70–73, 300
acid-fast stain, 344f
auramine stain, 74f
Burkholderia pseudomallei mimicking, 151
detecting repeated DNA sequences, 308
fast facts, 381t
Gram stain, 74f
Kinyoun stain, 73f
line probe assays, 317f
Lowenstein-Jensen agar slant, 76f
Middlebrook 7H11 agar, 76f
real-time polymerase chain reaction (PCR), 319f
susceptibility assays, 300
transcription-based amplification, 324f
- Mycobacterium tuberculosis* complex (MTBC), 70, 381
- Mycobacterium ulcerans*, 71
fast facts, 382t
- Mycobacterium xenopi*, 71
fast facts, 384t
Lowenstein-Jensen agar slant, 86f
Middlebrook 7H11 agar, 86f
- Mycoplasma* spp., 277–278
- Mycoplasma fermentans*, 277
- Mycoplasma genitalium*, 277
fast facts, 415t
transcription-based amplification, 324f
- Mycoplasma hominis*, 277, 278
A7 agar, 279f
chocolate agar, 279f
fast facts, 415t
Mycotrim GU triphasic culture system, 280f
- Mycoplasma pneumoniae*, 277, 278
fast facts, 415t
- Mycotrim GU triphasic culture system
Mycoplasma hominis, 280f
Ureaplasma urealyticum, 280f
- Myroides* spp., 159, 162t
blood agar, 164f

N

- NaCl tolerance test, *Mycobacterium*, 89f
- NaCl broth
- Aerococcus urinae*, 33f
 - Aeromonas hydrophila*, 140f
 - Enterococcus faecalis*, 33f
 - Gram-positive cocci, 31t
 - mycobacteria, 73t, 89f
 - Pseudomonas stutzeri*, 149f
 - Streptococcus bovis*, 33f
 - Vibrio alginolyticus*, 140f
- Nalidixic acid, *Helicobacter* spp., 268t
- Nathans, Daniel, 308
- Neisseria* spp., 184–185
- API NH identification system, 190f
 - biochemical reactions for, and
 - Moraxella catarrhalis*, 185t - chocolate agar, 345f
 - CTA sugars for identification, 189f
 - DNase plate for differentiation from
 - Moraxella catarrhalis*, 189f - Gonocheck-II system, 190f
 - modified Thayer-Martin agar, 346f
 - oxidase test for, 188f
 - Remel BactiCard *Neisseria* test, 190f
 - superoxol test for, 188f
 - transgrow bottle inoculation, 187f
- Neisseria elongata*, 184, 185
- Gram stain, 186f
- Neisseria flavescens*, 184, 185t
- chocolate agar, 186f
- Neisseria gonorrhoeae*, 184, 185t
- candle jar for, 187f
 - colistin disk differentiation test, 189f
 - comparing colonies of *N. meningitidis* and, 186f
 - cystine Trypticase agar carbohydrates, 352f
 - detection, 310
 - fast facts, 399t
 - Gram stain, 186f
 - helicase-dependent amplification, 326f
 - hybrid capture assay, 318f
 - JEMBEC plates for, 188f
 - real-time polymerase chain reaction (PCR), 319f
 - strand displacement amplification, 325f
 - superoxol test for, 188f
 - transcription-based amplification, 324f
- Neisseria lactamica*, 184, 185t
- chocolate agar, 187f
 - fast facts, 399t
- Neisseria meningitidis*, 184–185
- chocolate agar, 187f
 - comparing colonies of *N. gonorrhoeae* and, 186f
 - fast facts, 399t
 - Gram stain, 186f
- Neisseria sicca*, 184, 185t
- colistin disk differentiation test, 189f
- Neorickettsia* spp., 292
- Neorickettsia sennetsu*
- infections in humans, 292t
 - Sennetsu fever, 292
- Next-generation sequencing (NGS), 308
- NG-Test CARBA 5 phenotypic assay, carbapenemase detection, 305f
- Niacin accumulation test, mycobacteria, 73t, 88f
- Nitrate test
- Actinobacillus*, 171t
 - Bacillus* differentiation, 56t
 - biochemical test, 254t, 260f, 354f
 - Burkholderia* spp. 152t
 - Chromobacterium violaceum*, 177f
 - Gram-negative bacilli, 162t, 254t
 - Gram-positive bacilli, 242t
 - Helicobacter* spp., 268t
 - mycobacteria, 73t
 - Mycobacterium*, 88f
 - Nocardia brasiliensis*, 66f
 - Pseudomonas* spp., 146t
 - Ralstonia* spp., 152t
 - Streptomyces* spp., 69f
- o*-Nitrophenyl- β -D-galactopyranoside.
- See ONPG
 - (*o*-Nitrophenyl- β -D-galactopyranoside)
- Nocardia*, 62, 71, 309–310
- partially acid-fast stain with filamentous branches resembling, 341f
- Nocardia abscessus*, 62
- Nocardia asteroides*, 62
- 7H11 medium, 65f
 - acid-fast stain, 64f
 - decomposition, 63t
 - Gram stain, 64f
 - Nocardia* ID Quad plate, 65f
- Nocardia brasiliensis*, 62
- decomposition, 63t
 - fast facts, 380t
 - lysozyme test for, 66f
 - Sabouraud dextrose agar, 65f
 - in urea and nitrate broths, 66f
- Nocardia cyriacigeorgica*, 62
- fast facts, 380t
- Nocardia farcinica*, 62
- Nocardia* ID Quad plate, 63
- Actinomadura madurae*, 67f
 - Nocardia asteroides*, 65f
 - Streptomyces anulatus*, 68f
- Nocardia nana* complex, 62
- Nocardia nova*, 62
- Nocardia otitidiscaviarum*, 62
- decomposition, 63t
 - Sabouraud dextrose agar, 66f
- Nocardia pseudobrasiliensis*, 62
- Nocardia transvalensis* complex, 62
- Nocardia veterana*, 62
- Nocardia wallacei*, 62
- Nocardioptosis*, 64
- Nocardiosis, pulmonary, 361f
- Nonfermenters
- Gram-negative bacilli, 157–162
 - TSI agar slant inoculated with, 163f
- Novobiocin susceptibility,
- Staphylococcus saprophyticus*, 3, 9f
- Nucleic acid amplification test (NAAT), 12, 225, 273, 299, 300
- Ehrlichia chaffeensis*, 293
 - Tropheryma whippelli*, 297
 - Rickettsia*, 291
- Nucleic acid detection, 262
- Nutrient agar
- Aeromonas hydrophila*, 140f
 - colonies of *Cronobacter sakazakii*, 120f
 - Serratia rubidaea*, 122f
 - Vibrio alginolyticus*, 140f

O

- Oceanimonas*, 141
- Ochrobactrum* spp., 159, 162t
- OFBBL (oxidative-fermentative base polymyxin B-bacitracin-lactose) agar, 151
- Oligella* spp., 158t, 159, 162t
- ONPG (*o*-nitrophenyl-D-galactopyranoside), 115t
- Actinobacillus equuli*, 174f
 - biochemical test, 355f
 - Dysgonomonas*, 170
 - Enterobacteriales*, 95t
 - Klebsiella*, 115t
 - Raoultella*, 115t
 - Vibrionaceae*, 136t
- Optochin susceptibility, identification of
- Streptococcus pneumoniae*, 21
- Orbital cellulitis, 358f
- Ornithine decarboxylase (ODC)
- Aeromonas* spp., 142t
 - Citrobacter*, 123f
 - Enterobacter*, 115t, 119f, 121f, 123f
 - Enterobacteriales* members, 93t, 94t
 - Grimontia hollisae*, 136t
 - Haemophilus influenzae*, 192t, 196f
 - Klebsiella*, 115t, 123f
 - Pantoea*, 115t
 - Plesiomonas*, 117t
 - Proteaeae*, 117t
 - Raoultella*, 115t
 - Salmonella*, 106t
 - Serratia*, 116t, 123f
 - Staphylococcus lugdunensis*, 8f
 - Vibrionaceae*, 136t
 - Yersinia* spp., 130t

- Orientia*, epidemiology of common infection, 291t
- Orientia chuto*, 290, 291
- Orientia tsutsugamushi*, 291t
fast facts, 419t
- Ornithine decarboxylase test, identification of *Staphylococcus lugdunensis*, 8
- Ornithodoros*, 282
- Oxacillin, mannitol salt agar containing, 7f
- Oxidase test, 188f
- Actinobacillus*, 171t
- biochemical test, 355f
- Bordetella* spp., 198t
- Brevundimonas diminuta*, 152t
- Burkholderia* spp., 152t
- Comamonas testosteroni*, 152t
- Delftia acidovorans*, 152t
- Gram-negative bacilli, 158t, 162t
- Grimontia hollisae*, 136t
- Helicobacter* spp., 268t
- Kingella* spp., 172t
modified, 10f
- nonfermentative, Gram-negative bacilli, 158t
- Pasteurella* spp., 172t
- Photobacterium damsela*, 136t
- Pseudomonas* spp., 146t
- Pseudomonas stutzeri*, 149f
- Ralstonia* spp., 152t
- Vibrionaceae*, 136t
- P**
- Palisade formation, short, Gram-positive bacilli in, 340f
- Pandora* spp., 150, 152t
- Pantoea* spp., 91, 93t, 94t, 114
key characteristics, 115t
- Pantoea agglomerans*, API 20E system, 121f
- Paracoccus* spp., 158t, 162t
- Paracoccus yeii*, 159
- Para-Pal C&S system, *Campylobacter* spp., 263f
- Particle agglutination test, *Treponema pallidum*, 284, 288f
- Parvimonas micra*, 237
- CDC agar, 244f
- characteristics, 238t
- fast facts, 408t
- Gram stain, 243f
- Pasteurella* spp., 170–171
differentiating characteristics, 172t
- Pasteurella multocida*
- API 20NE identification, 179f
- blood agar, 178f
- fast facts, 397t
- Gram stain, 178f
- MacConkey agar, 178f
- Hektoen agar, 128f
- MacConkey agar, 128f
- PLM-5 medium, *Leptospira*, 282
- Pluralibacter*, 117
- PNA FISH (peptide nucleic acid fluorescent *in situ* hybridization) assay
- Enterococcus* spp., 29f
- Pseudomonas aeruginosa*, 149f
- Staphylococcus aureus*, 10f
- Pneumonia, 277
- Polymerase chain reaction (PCR), 308
- method, 319f
- multiplex PCR, 321f
- nested PCR, 320f
- real-time PCR, 319f
- reverse transcriptase PCR, 321f
- Polymorphonuclear leukocytes (PMLs), 341f
- Pontiac fever, 180
- Porphyrin production test, 195f
- Porphyromonas* spp.
- CDC agar, 257f
- characteristics, 214t, 254t
- disk pattern, 221f
- fast facts, 411t
- Gram stain, from CDC agar, 257f
- presumptive identification, 215t
- Porphyrin production test, 195f
- Port-A-Cul transport jar, 216f
- Port-A-Cul vial, 216f
- Positive cell culture
- Chlamydia pneumoniae*, 274f
- Chlamydia trachomatis*, 274f
- Positive inclusion indirect immunofluorescence assay, *Chlamydia trachomatis*, 276f
- PRAS. *See* Prereduced anaerobically sterilized (PRAS) media
- Premier Platinum HpSA Plus, 271f
- Prereduced anaerobically sterilized (PRAS) media, 213, 214
- PRAS plated medium, 218f
- Prevotella* spp., 252
- characteristics, 214t, 254t
- fast facts, 411t
- fluorescence on CDC agar, 257f
- kanamycin-vancomycin-brucella-laked sheep blood agar, 349f
- Prevotella corporis*
- CDC agar, 256f
- KVLB agar, 256f
- Prevotella melaninogenica*, Gram stain, with carbol fuchsin, 256f
- Primary plating media, 345f–349f
- growth of mixed aerobic and anaerobic organisms, 218f
- Propionibacterium* spp., characteristics, 214t
- PCR. *See* Polymerase chain reaction (PCR)
- Pediculus humanus* (sucking louse), 207
- Pediculus humanus humanus* (body louse), 282
- Pediococcus*, 30, 31t
fast facts, 375t
- Peptide nucleic acid (PNA) fluorescent *in situ* hybridization (FISH) differentiating *S. aureus* from CoNS, 10
- Enterococcus*, 29
- Pseudomonas aeruginosa*, 146, 149f
- Peptococcus niger*, 237
- Peptoniphilus asaccharolyticus*, 237
- characteristics, 238t
- Gram stain, 245f
- spot indole test for presumptive identification, 245f
- Peptostreptococcus anaerobius*, 237, 238
- CDC agar, 244f
- characteristics, 238t
- fast facts, 408t
- Gram stain, 244f
- metronidazole disk test, 251f
- presumptive identification, 215t
- SPS disk test, 245f
- Peptostreptococcus stomatis*, 237
- Periodic acid-Schiff (PAS) stain, 297
- Tropheryma whipplei*, 298f
- Peripheral blood stained with acridine orange, *Borrelia hermsii*, 287f
- Phadebact Haemophilus test, *Haemophilus influenzae*, 196f
- Phenotypic test for β -lactamase production, 305f
- Phenylalanine agar slant, *Psychrobacter phenylpyruvicus*, 164f
- Phenylalanine deaminase test
- biochemical test, 355f
- Citrobacter*, 123f
- Enterobacter*, 123f
- Enterobacteriales*, 95t
- Klebsiella*, 123f
- Serratia*, 123f
- Phenylethyl alcohol agar, 215t, 346f
- Clostridium perfringens*, 231f
- plating media, 346f
- Proteus* spp., 346f
- Photobacterium damsela*, 135, 136t
- Plague bacillus, 129
- Plating media, primary, 345f–349f
- Plesiomonas* spp., 91, 93t, 94t, 116–117, 142
- biochemical differentiation between members, 117t
- Plesiomonas shigelloides*, 116–117
- blood agar, 128f
- fast facts, 389t

- Propionibacterium acnes*, 239, 240
Proteae spp., 116
 biochemical differentiation between members, 117t
Proteus spp., 91, 93t, 94t, 95t, 113, 115
 blood agar, 96f
 modified Thayer-Martin agar, 346f
 phenylalanine deaminase test, 355f
 phenylethyl alcohol agar, 346f
Proteus mirabilis
 API 20E system, 125f
 BBL Crystal Enteric/Nonfermenter ID system, 99f
 blood agar, 124f
 fast facts, 388t
 Microbact Gram-negative ID system, 101f
 Micro-ID system, 99f
 TSI agar slant, 124f
Proteus vulgaris
 API 20E system, 125f
 fast facts, 388t
 TSI agar slant, 124f
Providencia, 113, 115
 phenylalanine deaminase test, 355f
Providencia alcalifaciens, API 20E system, 126f
Providencia rettgeri, API 20E system, 126f
Providencia stuartii, API 20E system, 126f
Pseudomonas spp., 142, 145–146
 differentiating characteristics, 146t
 modified Thayer-Martin agar, 346f
Pseudomonas aeruginosa, 145–146, 252
 blood agar, 147f
 fast facts, 393t
 Gram stain, 147f
 Gram stain of mucoid, 147f
 identified by PNA FISH, 149f
 MacConkey agar, 147f
 MIC testing by microdilution, 301f
 mucoid colonies, 148f
 Mueller-Hinton agar, 148f
 triple sugar iron agar slant, 148f
Pseudomonas alcaligenes, 145, 146t
Pseudomonas fluorescens, 145
 characteristics, 146t
 incubated with gelatin strips, 149f
Pseudomonas luteola, 145, 146t
Pseudomonas mendocina, 145, 146t
Pseudomonas monteilii, 145, 146t
Pseudomonas mosselii, 145, 146t
Pseudomonas oryzae, 145, 146t
Pseudomonas pseudoalcaligenes, 145, 146t
Pseudomonas putida, 145, 146t
Pseudomonas rRNA homology groups, 150
Pseudomonas stutzeri, 145
 blood agar, 148f
 characteristics, 146t
 fast facts, 393t
 in 6.5% NaCl broth, 149f
 by RapID NF Plus system, 149f
Pseudomonas veronii, 145, 146t
Pseudopropionibacterium spp., characteristics, 242
Psychrobacter spp., 158t, 159, 162t
Psychrobacter phenylpyruvicus
 blood agar, 164f
 phenylalanine agar slant, 164f
 Pulmonary actinomycosis, 362f
 Pulmonary infection, *Rhodococcus*, 361f
 Pulmonary nocardiosis, 361f
 Pulsed-field gel electrophoresis (PFGE), 315f
 Pyrazinamidase test, *Mycobacterium*, 89f
 Pyrosequencing, 327f
 L-Pyrrolidonyl- β -naphthylamide test, biochemical test, 355f
 PYR (pyrrolidonyl arylamidase) test, 12
Abiotrophia, 31t
 aerobic Gram-positive cocci, 31t
Aerococcus, 31t, 33f
 BactiCard, 23f
Dolosicoccus, 31t
Dolosigranulum, 31t
Enterococcus spp., 27f
Facklamia, 31t
Gemella, 31t
Globicatella, 31t
Granulicatella, 31t
Helcococcus, 31t
Ignavigranum, 31t
Lactococcus, 31t
Streptococcus pyogenes, 20f
Vagococcus, 31t
 Pyrazinamidase (PZA) test, mycobacteria, 73t, 89f
- R**
Ralstonia spp., 150, 152t
Ralstonia insidiosa, 150, 151, 152t
Ralstonia mannitolilytica, 150, 151, 152t
Ralstonia pickettii, 150, 151, 152t
 blood agar, 155f
 urea and mannitol reactions for, 155f
Raoultella spp., 113, 114
 key characteristics, 115t
 RapID CB Plus system, *Corynebacterium jeikeim*, 44f
 Rapid immunoassay, *Chlamydia trachomatis*, 275f
 RapID NF Plus system
Burkholderia cepacia, 154f
Delftia acidovorans, 156f
Pseudomonas stutzeri, 149f
Stenotrophomonas maltophilia, 156f
 RapID NH system, *Haemophilus* spp., 196f
 RapID onE system, 100f
 Rapid plasma reagin (RPR) test, 283
Treponema pallidum, 288f
 RapID STR system, streptococci identification, 23f
 Rapid test, *Legionella* antigen in urine 183f
 Red pigment, *Serratia*, 116t
 Regan-Lowe agar, 198
Bordetella pertussis, 200f
 Remel BactiCard Neisseria test, 190f
 Remel Micro-ID system, *Enterobacteriales*, 99f
 Restriction endonucleases, 308, 313f
 Restriction fragment length polymorphism (RFLP) analysis, 314f
 Reverse CAMP test
Arcanobacterium haemolyticum, 47f
Clostridium perfringens, 232f
 Rhamnose reaction
Salmonella spp., 106t
Yersinia spp., 130t
Rhizobium spp., 158t, 159–160, 162t
Rhizobium radiobacter, on MacConkey agar, 165f
Rhodococcus, 62, 63, 71
Rhodococcus equi, 63
 blood agar, 51f, 68f
 fast facts, 380t
 Gram stain, 67f
Rhodococcus pulmonary infection, 361f
 Ribose, 307, 311f. *See also* RNA (ribonucleic acid)
Rickettsia spp., 208, 290–291
 epidemiology of common infections, 291t
 microimmunofluorescence test for antibodies, 294f
Rickettsia felis, 291t
Rickettsia parkeri, 290, 291t
Rickettsia prowazekii, 290, 291t
 fast facts, 418t
Rickettsia rickettsii, 290, 291t, 296f
 fast facts, 418t
Rickettsia typhi, 290, 291t
 fast facts, 418t
 Rifampin, 300, 301
 RNA (ribonucleic acid)
 building blocks, 307, 311f
 DNA-RNA hybridization, 307, 313f
 hybrid capture assay, 318f
 nucleotides, 312f
 single-stranded RNA (ssRNA), 308
 transcription-based amplification, 324f

- Rocky Mountain spotted fever (RMSF), 290, 293, 296f
- Roseomonas* spp., 158t, 161–162
Sabouraud agar, 167f
- Rothia dentocariosa*, 37, 41t
clinical infections and characteristics, 39t
- RPR (rapid plasma reagin) test, 283
Treponema pallidum, 288f
- S**
- Sabouraud agar
Actinomadura madurae, 66f
Methylobacterium spp., 166f
Nocardia brasiliensis, 65f
Nocardia otitidiscaviarum, 66f
Roseomonas spp., 167f
Streptomyces spp., 68f
- Salicin test
Bacillus, 55
Grimontia hollisae, 136t
Vibrio, 136t
- Salmonella* spp., 91, 92, 93t, 94t, 105–106
characteristic reactions, 106t
CHROMagar, 110f, 347f
fast facts, 386t
H₂S-positive colonies on HE agar, 97f
H₂S-positive colonies on XLD agar, 97f
HE agar, 109f
Hektoen enteric agar, 346f
triple sugar iron (TSI) agar, 102f, 356f
TSI agar slant, 111f
XLT4 agar, 110f
- Salmonella enterica* serotype Typhi
in API 20E system, 112f
TSI agar slant, 111f
- Salmonella enterica* serovar Typhi, TSI agar, 102f
- Salmonella* serotype Typhi
in API 20E system, 112f
bismuth sulfite agar, 110f
IMViC reactions, 111f
- Sanger, Frederick, 308
- Sanger method (DNA sequencing), 326f
- Schlichter test, 300
- Scrub typhus, *Orientia tsutsugamushi*, 291
- Secondary syphilis, 366f
- Septic cerebral embolism, 358f
- Segniliparus*, 64
- Sennetsu fever, 292
- Sentinel Level Clinical Laboratory Microbiology Guidelines, 130
- Serratia* spp., 91, 92, 93t, 94t, 113, 114
blood agar, 96f
Enterotube II identification system, 123f
IMViC reactions, 119f
key characteristics, 116t
TSI agar slant, 119f
- Serratia marcescens*, 114
fast facts, 388t
MacConkey agar, 118f
- Serratia rubidaea*, colonies, on
blood, MacConkey and nutrient agars, 122f
- Serum bactericidal test, 300
- Serological testing, *Brucella* spp., 206f
- Serotyping, *Haemophilus influenzae*, 196f
- Sheep blood agar, 31, 345f, 347f
Achromobacter xylosoxidans, 202f
Alcaligenes faecalis, 202f
Enterococcus faecalis, 25f
Enterococcus faecium, 25f
- Shell vial culture, *Coxiella burnetii*, 295f
- SHERLOCK (specific high-sensitivity enzymatic reporter unlocking) test, 309
- Shewanella* spp., 158t, 160, 162t
Shewanella putrefaciens
blood agar, 165f
DNase agar, 166f
TSI agar slant, 165f
- Shiga toxin-producing *E. coli* (STEC), 103
- Shigella* spp., 91, 93t, 94t, 104–105
characteristic reactions, 104t
colonies, on MacConkey agar, 108f
fast facts, 386t
HE agar, 97f, 109f
Hektoen enteric agar, 346f
triple sugar iron (TSI) agar, 102f, 356f
TSI agar slant, 109f
- Shigella sonnei*, API 20E system, 132f
- Sickle cell disease, 105
- Šikšnys, Virginijus, 309
- Silver stain, liver of congenital syphilis patient, 287f
- Small intestine biopsy, Whipple's disease, 298f
- Sorbitol reaction
Citrobacter, 123d
Enterobacter, 115t, 123f
Escherichia coli, 104t
Klebsiella, 123f
Pantoea, 115t
Serratia, 116t, 123f
Shigella, 104t
- Slide coagulase test, *Staphylococcus*, 2, 6f
- Society for Health Care Epidemiology of America, 225
- Southern blotting, 316f
- Special stains, 338
- Sphingobacterium* spp., 158t, 160, 162t
Sphingomonas spp., 158t, 160, 162t
Sphingomonas paucimobilis, blood agar, 165f
- Spore stain, *Bacillus anthracis*, 57f
- Spot indole test
Bacteroides thetaiotaomicron, 256f
Peptoniphilus asaccharolyticus, 245f
- SPS (sodium polyanethol sulfonate) disk test, 238, 245f
- Sputum specimen
Gram stain of high-quality, 341f
Gram stain of low-quality, 342f
Kinyoun stain, 344f
- Stains, 338, 339f–344f
Gram stain, 338
hematoxylin and eosin (H&E), 338, 358f, 359f, 360f
special, 338
- Staphylococcus* spp., 1
API Staph identification system, 10f
assays, 300
coagulase slide and tube test, 351f
coagulase test, 6f, 351f
MALDI-TOF, 3
modified oxidase test, 10f
- Staphylococcus aureus*, 1, 192
blood agar, 4f, 51f
coagulase slide and tube test, 351f
coagulase test, 2, 6f
DNase plate differentiating, from CoNS, 3, 8f
fast facts, 368t
fluorescent *in situ* hybridization, 318f
golden pigment, 4f
Gram stain, 4f
latex test for identification, 6f
MALDI-TOF MS, 310
mannitol salt agar, 6f
methicillin-resistant (MRSA), 2–3, 300
oxacillin screening, 2
PNA FISH assay, 10f
real-time polymerase chain reaction (PCR), 319f
septic cerebral embolism, 358f
size variation, 5f
slide coagulase test, 6f
spectra MRSA, 7f
thermostable endonuclease activity, 8f
- Staphylococcus epidermidis*, 1, 2
bacitracin susceptibility, 9f
blood agar, 5f
fast facts, 368t
modified oxidase test, 10f
- Staphylococcus haemolyticus*, 1
- Staphylococcus lugdunensis*, 1, 3
blood agar, 5f
fast facts, 368t
ornithine decarboxylase test for identification, 8f
slide coagulase test, 6f

- Staphylococcus saccharolyticus*, 237
Staphylococcus saprophyticus, 1, 3
 fast facts, 368t
 lysostaphin susceptibility, 9f
 novobiocin susceptibility, 9f
Staphylococcus schleiferi, 1, 3, 8f
 fast facts, 369t
 slide coagulase test, 6f
Stenotrophomonas spp., 150, 151
 key characteristics, 152t
Stenotrophomonas maltophilia,
 151, 152t
 blood agar, 154f
 DNase agar, 154f
 fast facts, 394t
 by RapID NF Plus system, 156f
 Stephens, William E., 309
 Strand displacement amplification, 325f
Streptobacillus spp., 171
 differentiating characteristics, 172t
Streptobacillus moniliformis, 171
 in broth medium, 177f
 differentiating characteristics, 172t
 fast facts, 397t
 Streptococci
 BactiCard for identification, 23f
 RapID STR system for identifying, 23f
 toxic shock syndrome with necrotizing
 fasciitis, 359f
 See also Viridans group streptococci
Streptococcus spp., 11
 beta-, alpha- and gamma-hemolysis
 blood agar, 17f
 disk diffusion (Kirby-Bauer)
 antimicrobial susceptibility
 test, 301f
Streptococcus agalactiae, 12, 103
 blood agar, 17f
 CAMP test for identification, 20f
 carrot broth for direct detection, 19f
 fast facts, 370t
 Granada agar for detection, 19f
 hippurate test for identification, 21f
 L-pyrrolidonyl- β -naphthylamide
 test, 355f
 real-time polymerase chain reaction
 (PCR), 319f
 selection for, 19f
Streptococcus alactolyticus, 14
Streptococcus anginosus, 15
 fast facts, 371t
 orbital cellulitis, 358f
Streptococcus bovis, 14–15
 bile esculin agar, 350f
 bile esculin agar slants, 33f
 differentiation from *Enterococcus*
faecium, 22f
Streptococcus bovis group, blood
 agar, 18f
Streptococcus constellatus, 15
 blood agar, 17f
 growth enhancement in presence of
 CO₂, 18f
Streptococcus criceti, 15
Streptococcus cristatus, 15
Streptococcus downei, 15
Streptococcus dysgalactiae subsp.
equisimilis, 12–13
 fast facts, 370t
Streptococcus equinus, 14
Streptococcus gallolyticus, 14
 fast facts, 371t
Streptococcus gordonii, 15
Streptococcus infantarius, 14
Streptococcus intermedius, 15
Streptococcus milleri group, 15
Streptococcus mitis, 15
 fast facts, 371t
Streptococcus mitis-Streptococcus oralis,
 orbital cellulitis, 358f
Streptococcus mutans, 15
 fast facts, 371t
 Gram stain, 16
Streptococcus oralis, 15
Streptococcus parasanguinis, 15
Streptococcus pneumoniae, 13, 48, 49
 bile solubility test for
 identification, 21f
 blood agar, 18f
 chocolate agar, 18f
 fast facts, 370t
 Gram stain, 16f
 inoculation of killed form, 307
 morphology, 339f
 optochin susceptibility for
 identification, 21f
Streptococcus pyogenes, 11–12
 bacitracin susceptibility, 9f
 bacitracin susceptibility test for, 20f
 bile esculin agar, 350f
 blood agar, 17f, 345f
 fast facts, 370t
 Gram stain, 16f
 PYR test for, 20f
 L-pyrrolidonyl- β -naphthylamide
 test, 355f
 toxic shock syndrome with necrotizing
 fasciitis, 359f
Streptococcus rattii, 15
Streptococcus salivarius, 15
Streptococcus sanguinis, 15
Streptococcus sobrinus, 15
Streptococcus thermophilus, 15, 309
Streptococcus vestibularis, 15
Streptomyces spp., 62
 lysozyme test for, 69f
 Sabouraud dextrose agar, 68f
 in urea and nitrate broths, 69f
Streptomyces anulatus
 decomposition, 63t
 Nocardia ID Quad plate, 68f
Streptomyces somaliensis,
 decomposition, 63t
 String test, *Vibrio* spp. presumptive
 identification, 140f
 Stuart's medium, *Leptospira*, 282
 Sucrose test
Actinobacillus, 171t
Dysgonomonas, 172t
Haemophilus spp., 192t
Neisseria, 185t
Pasteurella, 172t
Vibrionaceae, 136t
Yersinia spp., 130t
p-Sulfobenzene-azo- α -naphthylamine
 dye, 354f
 Sulfur granules, hematoxylin and eosin
 stain, 246f
 Superoxol test, 188f
Suttonella indologenes, 171
 differentiating characteristics, 172t
 SYBR Green I dye, 320f
 Synergy testing, *Enterococcus*, 306f
 Syphilis, 283–285
 Syphilis, secondary, 366f
- T**
 T2H (thiophene-2-carboxylic acid
 hydrazide), mycobacteria, 73t
 Tanaka, Koichi, 309
 TaqMan, 320f
Tatumella, 91
 TCBS (thiosulfate-citrate-bile salts-
 sucrose) agar, 135
Vibrio alginolyticus, 138f
Vibrio cholerae, 137f
Vibrio parahaemolyticus, 138f
 Tellurite agar, *Corynebacterium*
diphtheriae, 43f
 Tellurite reduction test,
Mycobacterium, 89f
 Temin, Howard, 308
 Thayer-Martin agar
Francisella tularensis on modified,
 212f
Haemophilus spp., 346f
Helicobacter pylori, 268f, 270f
Methylobacterium spp., 166f
 plating media, 346f
 transgrow bottle inoculation, 187f
Thermophilus aquaticus DNA
 polymerase, 308
 Thermostable endonuclease activity,
Staphylococcus aureus, 8f
 Thioglycolate broth, 215t
Haemophilus ducreyi, 195f
Haemophilus influenzae, 195f

- Thionine
Brucella spp., 204t
 Thymine, 307, 311f, 312f
 Toluidine blue, DNase test, 3, 352f
Tolumonas, 141
 Total laboratory automation (TLA), 330–331
 antimicrobial susceptibility testing (AST) systems, 330
 APAS Independence, 330, 336f
 BD Kiestra InoqulA+ specimen processor, 330, 332f
 BD Kiestra Total Lab Automation (TLA) system, 331, 333f
 BD Kiestra Work Cell Automation (WCA) system, 332f
 Collaborative Robot module, 337f
 digital imaging, 334f–335f
 liquid-based transport systems, 330, 331f
 specimen processors, 330
 streaking process, 330, 336f
 Walk-Away Specimen Processor (WASP) DT, 330, 333f, 334f
 WASP-FLO, 337f
 WASPLab, 337f
 WASPLab automated system, 331, 334f, 337f
 Toxic shock syndrome with necrotizing fasciitis, streptococcal, 359f
 Toxin assay, Shiga toxins by strains of *Escherichia coli*, 108f
 Transcription-based amplification, 324f
 Trehalose reaction
 Plesiomonas, 117t
 Proteaeae, 117t
Treponema spp., 283–285
Treponema pallidum, 283–285
 dark-field micrograph, 287f
 fast facts, 417t
 FTA-ABS DS test, 288f
 INNO-LIA Syphilis Score, 289f
 particle agglutination test, 288f
 rapid plasma reagin (RPR) test, 283, 288f
 secondary syphilis, 366f
 silver stain preparation from liver with congenital syphilis, 287f
 Trep-Sure Syphilis Total Antibody assay, 289f
 Trimethoprim, 346f
 Triphenyltetrazolium dye, *Bacillus anthracis*, 59f
 Triple sugar iron (TSI) agar, 102f, 356f
 Actinobacillus equuli, 174f
 biochemical test, 356f
 Burkholderia cepacia, 153f
 Campylobacter jejuni, 265f
 Citrobacter, 119f
 Edwardsiella tarda, 127f
 Enterobacter, 119f
 Enterobacteriales, 92, 94t, 102f
 Erysipelothrix rhusiopathiae, 53f
 Escherichia coli, 104t, 107f
 Hafnia alvei, 127f
 Klebsiella, 119f
 non-fermenter, 163f
 Proteus mirabilis, 124f
 Proteus vulgaris, 124f
 Pseudomonas aeruginosa, 148f
 Salmonella spp., 106t, 111f
 Salmonella enterica serotype Typhi, 111f
 Serratia, 119f
 Shewanella putrefaciens, 165f
 Shigella spp., 104t, 109f
 Vibrio spp., 139f
 Yersinia enterocolitica, 132f
Tropheryma whipplei, 297
 fast facts, 420t
 small intestine biopsy specimen from patient, 298f
 Whipple's disease, 297
Trueperella bernardiae, 37, 41t
 clinical infections and characteristics, 40t
Trueperella pyogenes, 37, 41t
 clinical infections and characteristics, 40t
 Gram stain, 46f
 Trypticase soy broth, 345f
 modified carbapenem inactivation method (mCIM), 304f
 TSI. *See* Triple sugar iron (TSI) agar
Tsukamurella spp., 62, 63–64
 Tsutsugamushi triangle, 291
 Tularemia, 210–211
Turicella otitidis, 37, 41t
 clinical infections and characteristics, 40t
 Turing, Alan, 310
 Tween 80 hydrolysis, mycobacteria, 73t, 90f
- U**
 Uracil, 307, 311f
 Urea agar
 Actinobacillus spp., 174f
 Bacillus anthracis, 56f
 Bordetella bronchiseptica, 202f
 Bordetella parapertussis, 202f
 Bordetella pertussis, 202f
 Corynebacterium urealyticum, 46f
 Methylobacterium spp., 167f
 Nocardia brasiliensis, 66f
 Streptomyces spp., 69f
 Yersinia enterocolitica, 132f
 Urea breath test (UBT), 268
Urea parvum, 277
Ureaplasma urealyticum, 277
 A7 agar, 280f
 fast facts, 415t
 Mycotrim GU triphasic culture system, 280f
 urea test for identification, 280f
 Urea/urease test, 90f, 357f
Actinobacillus, 171t
Bordetella spp., 198t
Brucella spp., 204t, 206f
Burkholderia cepacia, 155f
Campylobacter ureolyticus, 266f
Clostridium sordellii, 234f
Enterobacter, 115t
Pantoea, 115t
Ralstonia pickettii, 155f
Enterobacteriales, 95t
 Gram-positive bacilli, 242t
Haemophilus influenzae, 192t, 196f
Helicobacter spp., 268t
 mycobacteria, 73t, 90f
Plesiomonas, 117t
Proteaeae, 117t
Ureaplasma urealyticum, 280f
Yersinia spp., 130t
 Urinary tract infections (UTI), 103
 U.S. Food and Drug Administration, 299
- V**
 Vaginalis agar (V agar), *Gardnerella vaginalis*, 47f
Vagococcus, 30, 31t
 Vancomycin, colistin, nystatin (V-C-N inhibitor), 346f
 Vancomycin-dependent *Enterococcus faecalis*, 26f
 Vancomycin-intermediate *Staphylococcus aureus* (VISA), 2
 Vancomycin resistance, *Leuconostoc*, 34f
 Vancomycin-resistant enterococci (VRE), 24
 Vancomycin-resistant *Staphylococcus aureus* (VRSA), 2
 Vancomycin susceptibility
 aerobic Gram-positive cocci, 31t
 Enterococcus strains, 26f
Veillonella spp., 252, 253
 characteristics, 214t, 254t
 disk pattern, 221f
 fast facts, 411t
 Gram stain, 260f
 nitrate disk test, 260f
 presumptive identification, 215t
Veillonella parvula, CDC agar, 260f

- Vibrio* spp., 134–136
 clinical specimens, 136t
 Gram stain, 137f
 presumptive identification, by string test, 140f
 TSI agar slant, 139t
- Vibrio alginolyticus*, 134, 135
 API 20E system, 139t
 blood agar, 137f
 inoculated into 6.5% NaCl broth, 140f
 inoculated on nutrient agar, 140f
 TCBS agar, 138f
- Vibrio cholerae*, 134–135
 blood agar, 137f
 fast facts, 391t
 TCBS agar, 137f
- Vibrio fluvialis*, 134, 136t
- Vibrio metschnikovii*, 135, 136t
 fast facts, 391t
- Vibrio mimicus*, 134, 135
 blood agar, 140f
- Vibrionaceae*, 134, 135
 clinical specimens, 136t
- Vibrio parahaemolyticus*, 134, 135, 136t
 blood agar, 138f
 fast facts, 391t
 TCBS agar, 138f
- Vibrio vulnificus*, 134, 135, 136t
 fast facts, 391t
- Viridans group streptococci, 13–15
 anginosus group, 14t, 15
 BactiCard, 23f
 Gram stain, 16f
 grouping, 14t
 mitis group, 14t, 15
 mutans group, 14t, 15
 salivarius group, 14t, 15
S. bovis group (group D streptococci), 14t, 14–15
- Voges-Proskauer broth, *Yersinia enterocolitica*, 132f
- Voges-Proskauer test (VP), 12, 104t, 106t, 115t, 357f
Aeromonas spp., 142t
Aeromonas hydrophila, 144f
- biochemical test, 357f
Citrobacter, 120f, 123f
Enterobacter, 119f, 123f
Enterobacteriales, 115
Escherichia coli, 104t, 108f
 IMViC reactions of *Escherichia coli*, 108f
 IMViC reactions of *Salmonella* serotype Typhi, 111f
Klebsiella, 115t, 119f, 123f
Raoultella, 115t
Salmonella spp., 106t
Serratia, 119f, 123f
Shigella, 104t
- W**
- Walk-Away Specimen Process (WASP) DT, 331, 333f
- Warthin-Starry silver stain, 338
Bartonella henselae, 209f, 364f
Brachyspira spp., 285, 289f
 cat scratch disease, 364f
Helicobacter pylori, 269f
 liver of congenital syphilis patient, 287f
 secondary syphilis, 366f
- WASPLab automated system, 331, 334f, 337f
- Watson, James, 307
- Wayson stain, 130
- Weil-Felix test, *Proteus* antigens, 291
- Weissella*, 30, 31t
 fast facts, 375t
- Weissella confusa*, 30
- Whipple's disease, 297
 small intestine biopsy specimen from patient, 298f
- Williamsia*, 64
- Wohlfahrtiimonas* spp., 158t, 159, 162t
- Wolbachia* spp., 292
- Work cell automation (WCA) system, BD Kiestra, 332f
- World Health Organization (WHO), 134, 282
- Wright's stain, *Yersinia pestis*, 130
- Wright-stained peripheral blood smear
- Borrelia burgdorferi*, 286f
Ehrlichia ewingii, 294f
- X**
- Xenopsylla cheopis* (rat flea), 290
- XLD (xylose lysine deoxycholate) agar
Escherichia coli, 104
 H₂S-positive *Salmonella* colonies, 97f
- XLT4 agar, *Salmonella*, 110f
- Xylose reaction
Burkholderia spp. 152t
Escherichia coli, 104t
Pseudomonas spp., 146t
- Y**
- Yersinia* spp., 91, 93t, 94t, 129–130, 142
- Yersinia enterocolitica*, 129–130
 API 20E system, 132f
 biochemical reactions, 130t
 blood agar, 96f, 131f
 CIN agar, 98f, 133f
 fast facts, 390t
 Gram stain, 131f
 MacConkey agar, 131f
 in methyl red and Voges-Proskauer broth, 132f
 triple sugar iron (TSI) agar, 102f, 356f
 TSI and urea agar slants, 132f
- Yersinia pestis*, 129–130
 biochemical reactions, 130t
 blood agar, 133f
 detecting repeated DNA sequences, 308
 direct fluorescent-antibody stain, 133f
 fast facts, 390t
 Gram stain, 131f
- Yersinia pseudotuberculosis*, 129–130
 biochemical reactions, 130t
 fast facts, 390t
- Z**
- Zhang, Fen, 309
- Ziehl-Nielsen procedure, 72, 73
 acid-fast stain, 344f
Mycobacterium tuberculosis, 73f
- Zuse, Konrad, 310